

GSM3912P

30V N-Channel MOSFETs

Product Description

These N-Channel enhancement mode power field effect transistors are using trench DMOS technology. This advanced technology has been especially tailored to minimize on-state resistance, provide superior switching performance, and withstand high energy pulse in the avalanche and commutation mode.

These devices are well suited for high efficiency fast switching applications.

Features

- 30V, 6.5A, $R_{DS(ON)}=24m\Omega@V_{GS}=10V$
- Improved dv/dt capability
- Fast switching
- 100% EAS Guaranteed
- Green Device Available
- SOT-23 package design

Applications

- MB / VGA / Vcore
- Load Switch
- Hand-Held Instrument

Packages & Pin Assignments

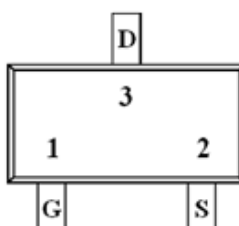
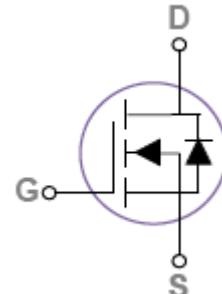
GSM3912PJZF (SOT-23)	
 <p>Top Views</p>	
	
Pin	Description
1	Gate
2	Source
3	Drain

Ordering Information

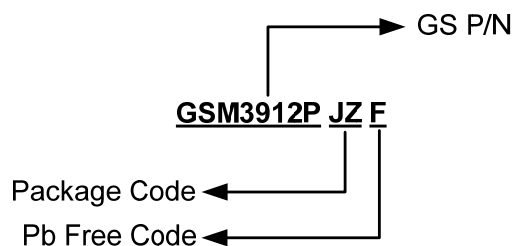

Marking Information

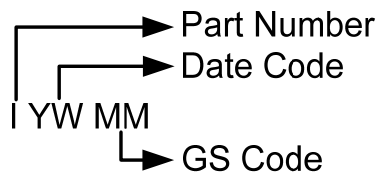

Part Number	Package	Part Marking	Quantity
GSM3912PJZF	SOT-23	IYWMM	3000pcs

Absolute Maximum Ratings

$T_A=25^\circ\text{C}$ Unless otherwise noted

Symbol	Parameter	Typical	Unit
V_{DS}	Drain-Source Voltage	30	V
V_{GS}	Gate-Source Voltage	± 20	V
I_D	Continuous Drain Current	$T_A=25^\circ\text{C}$	6.5
		$T_A=100^\circ\text{C}$	4.1
I_{DM}	Pulsed Drain Current	26	A
EAS	Single Pulse Avalanched Energy	32	mJ
IAS	Single Pulse Avalanched Current	8	A
P_D	Power Dissipation ($T_A=25^\circ\text{C}$)	1.56	W
	Power Dissipation (Derate above 25°C)	0.012	W/ $^\circ\text{C}$
T_J	Operating Junction Temperature Range	-55 to +150	$^\circ\text{C}$
T_{STG}	Storage Temperature Range	-55 to +150	$^\circ\text{C}$
$R_{\theta JA}$	Thermal Resistance-Junction to Ambient	80	$^\circ\text{C}/\text{W}$

Electrical Characteristics

T_A=25°C Unless otherwise noted

Symbol	Parameter	Conditions	Min	Typ	Max	Unit
Static						
V _{(BR)DSS}	Drain-Source Breakdown Voltage	V _{GS} =0V, I _D =250uA	30			V
ΔBV _{DSS} /ΔT _J	BV _{DSS} Temperature Coefficient	Reference to 25°C, I _D =1mA		0.04		V/°C
V _{GS(th)}	Gate Threshold Voltage	V _{DS} =V _{GS} , I _D =250uA	1.2	1.6	2.5	V
ΔV _{GS(th)}	V _{GS(th)} Temperature Coefficient			-4		mV/°C
I _{GSS}	Gate Leakage Current	V _{DS} =0V, V _{GS} =±20V			±100	nA
I _{DSS}	Zero Gate Voltage Drain Current	V _{DS} =30V, V _{GS} =0V			1	uA
		V _{DS} =24V, V _{GS} =0V, T _J =125°C			10	
I _S	Continuous Source Current	V _G =V _D =0V, Force Current			6.5	A
I _{SM}	Pulsed Source Current				26	
R _{DS(on)}	Drain-Source On-Resistance	V _{GS} =10V, I _D =6A		20	24	mΩ
		V _{GS} =4.5V, I _D =4A		27	34	
g _{FS}	Forward Transconductance	V _{DS} =10V, I _D =4A		6.5		S
V _{SD}	Diode Forward Voltage	V _{GS} =0V, I _S =1A			1	V
Dynamic						
Q _g	Total Gate Charge	V _{DS} =15V, V _{GS} =4.5V, I _D =6A		4.1	8	nC
Q _{gs}	Gate-Source Charge			1	2	
Q _{gd}	Gate-Drain Charge			2.1	4	
C _{iss}	Input Capacitance	V _{DS} =25V, V _{GS} =0V, f=1MHz		345	500	pF
C _{oss}	Output Capacitance			55	80	
C _{rss}	Reverse Transfer Capacitance			32	45	
t _{d(on)}	Turn-On Time	V _{DD} =15V, I _D =1A, V _{GS} =10V, R _G =6Ω		2.8	5	ns
t _r				7.2	14	
t _{d(off)}	Turn-Off Time			15.8	30	
t _f				4.6	9	
R _g	Gate Resistance	V _{DS} =0V, V _{GS} =0V, f=1MHz		3.2	6.4	Ω

Typical Performance Characteristics

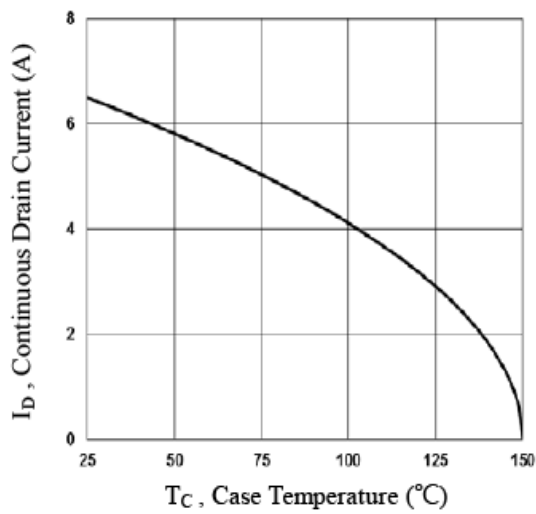

Fig.1 Continuous Drain Current vs. T_c

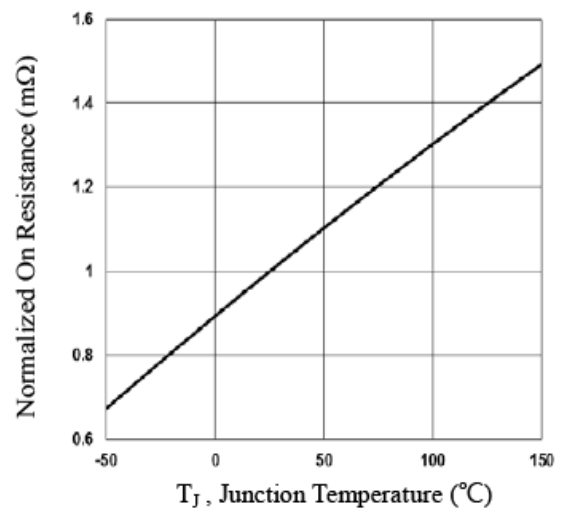

Fig.2 Normalized $R_{DS(on)}$ vs. T_j

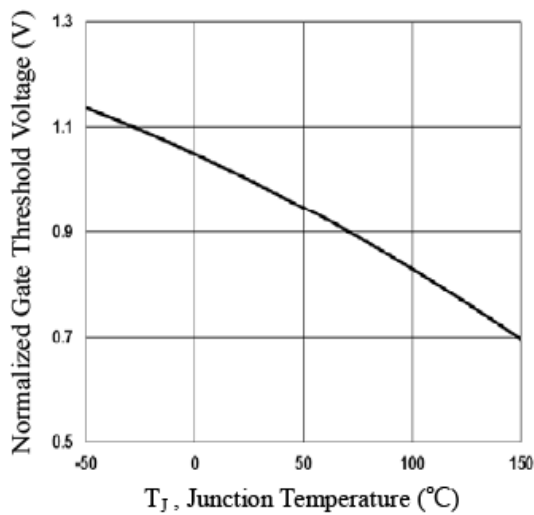

Fig.3 Normalized V_{th} vs. T_j

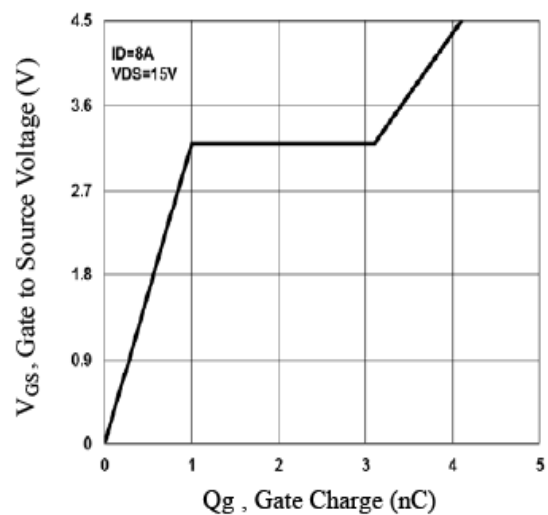

Fig.4 Gate Charge Waveform

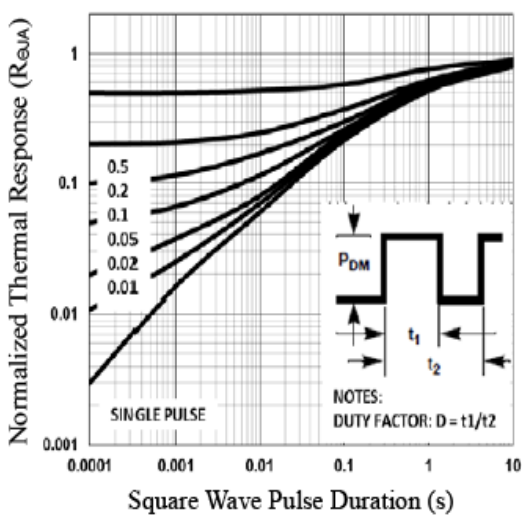

Fig.5 Normalized Transient Response

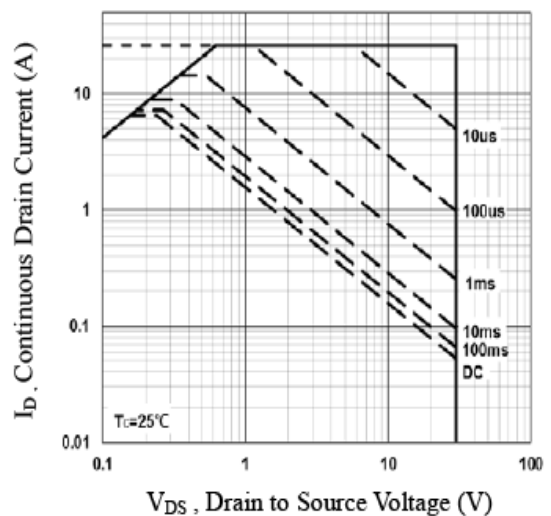
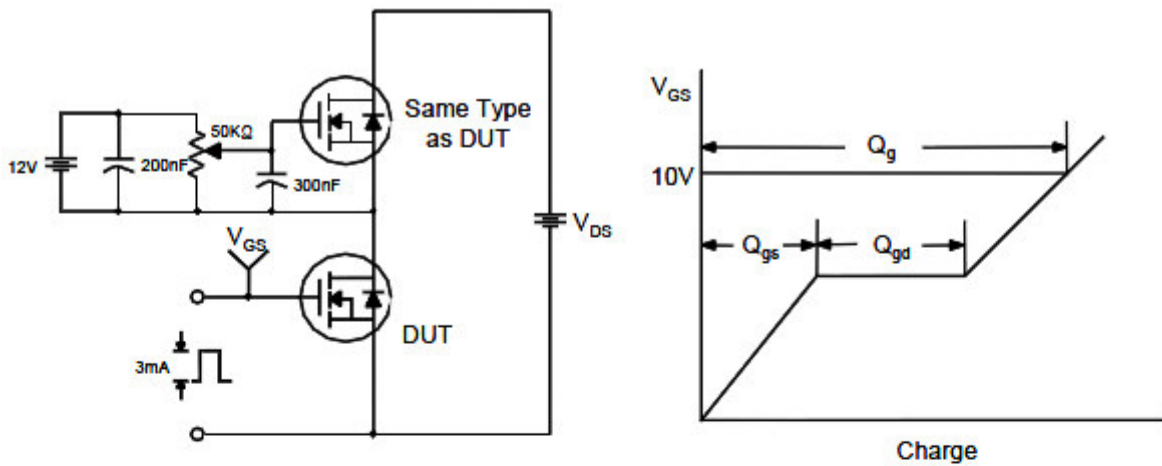

Fig.6 Maximum Safe Operation Area

Typical Performance Characteristics (Continue)

Gate Charge Test Circuit & Waveform



Resistive Switching Test Circuit & Waveforms

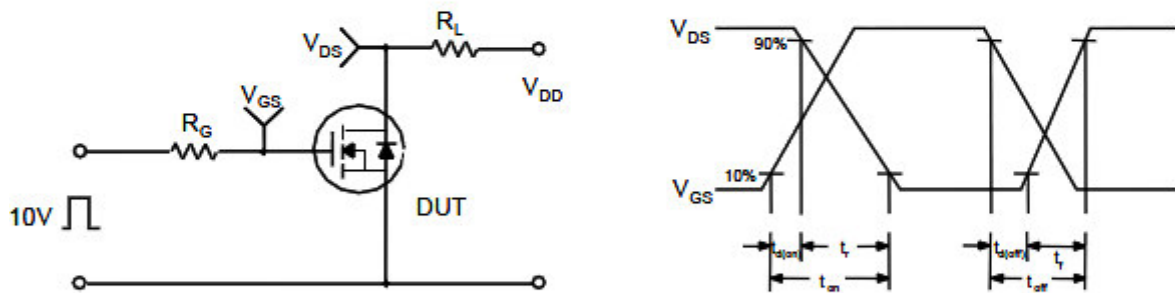

Unclamped Inductive Switching Test Circuit & Waveforms

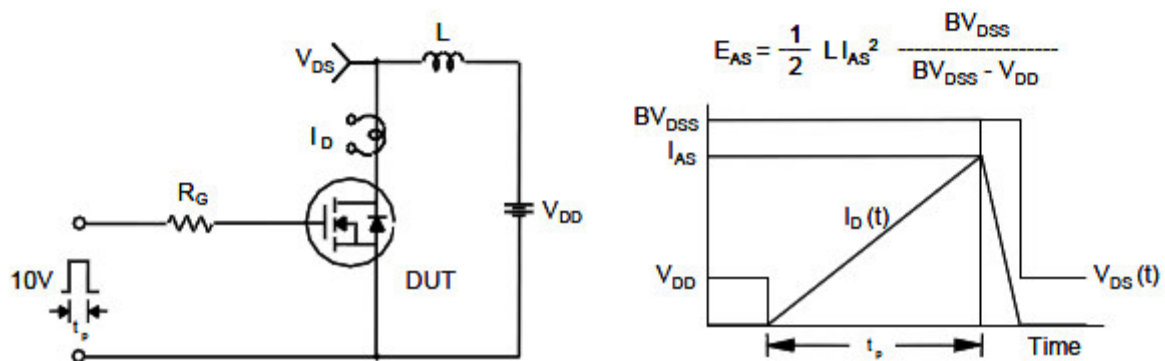

Package Dimension

SOT-23

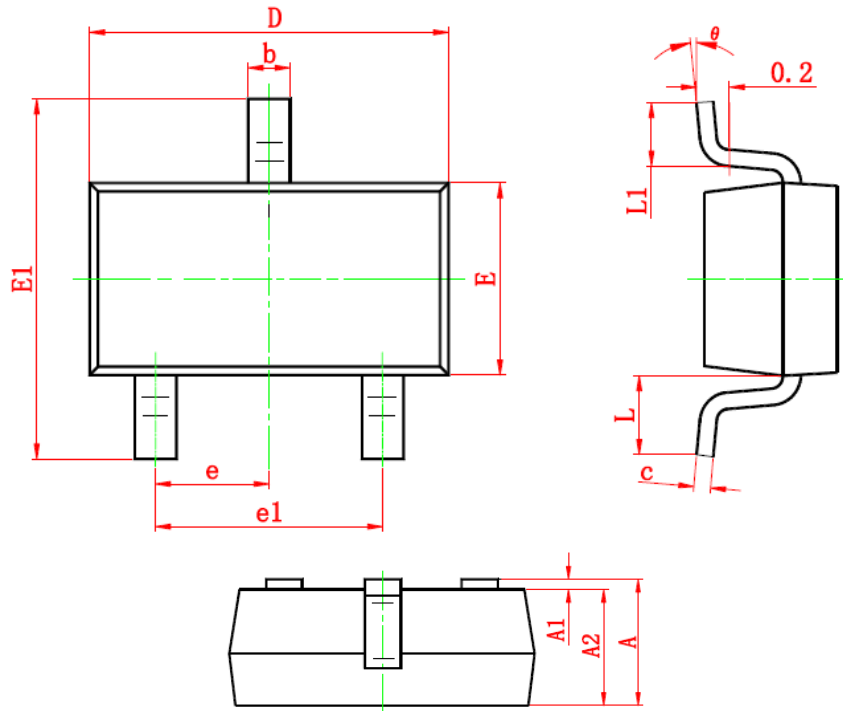







Dimensions				
Symbol	Millimeters		Inches	
	Min	Max	Min	Max
A	0.900	1.200	0.035	0.043
A1	0.000	0.100	0.000	0.004
A2	0.900	1.100	0.035	0.039
b	0.300	0.500	0.012	0.020
c	0.080	0.150	0.003	0.006
D	2.800	3.000	0.110	0.118
E	1.200	1.400	0.047	0.055
E1	2.250	2.550	0.089	0.100
e	0.950 TYP		0.037 TYP	
e1	1.800	2.000	0.071	0.079
L	0.550 REF		0.022 REF	
L1	0.300	0.500	0.012	0.020
θ	0°	8°	0°	6°



NOTICE

Information furnished is believed to be accurate and reliable. However Globaltech Semiconductor assumes no responsibility for the consequences of use of such information nor for any infringement of patents or other rights of third parties, which may result from its use. No license is granted by implication or otherwise under any patent or patent rights of Globaltech Semiconductor. Specifications mentioned in this publication are subject to change without notice. This publication supersedes and replaces all information without express written approval of Globaltech Semiconductor.

CONTACT US

GS Headquarter	
	4F.,No.43-1,Lane11,Sec.6,Minquan E.Rd Neihu District Taipei City 114, Taiwan (R.O.C)
	886-2-2657-9980
	886-2-2657-3630
	sales_twn@gs-power.com

Shenzhen Branch(China)	
	1113 B Building, Happiness Washington, Baoan Nan Road, Luohu District, Shenzhen City, China
	0755-22208941
	sales_cn@gs-power.com

RD Division	
	824 Bolton Drive Milpitas. CA. 95035
	1-408-457-0587