

GSMDC3906Z

30V N-Channel MOSFETs

Product Description

These N-Channel enhancement mode power field effect transistors are using trench DMOS technology. This advanced technology has been especially tailored to minimize on-state resistance, provide superior switching performance, and withstand high energy pulse in the avalanche and commutation mode.

These devices are well suited for high efficiency fast switching applications.

Features

- 30V, 60A, $R_{DS(ON)}=6m\Omega@V_{GS}=10V$
- Improved dv/dt capability
- Fast switching
- 100% EAS guaranteed
- Green Device Available
- DFN3X3-8L package design

Applications

- MB / VGA / Vcore
- POL Applications
- SMPS 2nd SR

Packages & Pin Assignments

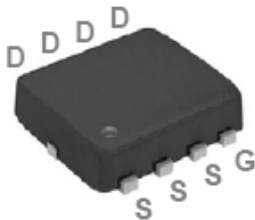
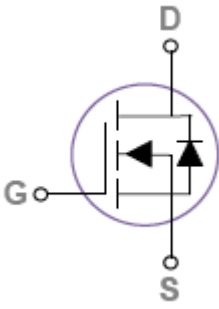
GSMDC3906ZFF (DFN3X3-8L)	
 <p>Top View</p>	
	
Pin	Description
1	Source
2	Source
3	Source
4	Gate
5	Drain
6	Drain
7	Drain
8	Drain

Ordering Information

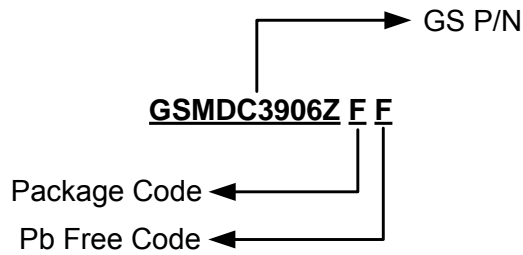

Part Number	Package
GSMDC3906ZFF	DFN3X3-8L

Marking Information

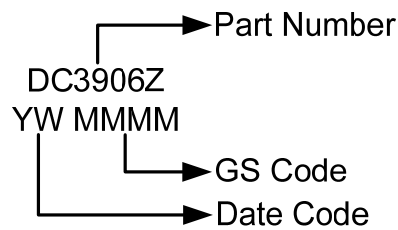

Absolute Maximum Ratings

$T_A=25^{\circ}\text{C}$ Unless otherwise noted

Symbol	Parameter	Typical	Unit
V_{DS}	Drain-Source Voltage	30	V
V_{GS}	Gate-Source Voltage	± 20	V
I_D	Continuous Drain Current	$T_A=25^{\circ}\text{C}$	60
		$T_A=100^{\circ}\text{C}$	38
I_{DM}	Pulsed Drain Current	240	A
EAS	Single Pulse Avalanche Energy	88	mJ
IAS	Single Pulse Avalanche Current	42	A
P_D	Power Dissipation ($T_A=25^{\circ}\text{C}$)	45	W
	Power Dissipation (Derate above 25°C)	0.36	W/ $^{\circ}\text{C}$
T_J	Operating Junction Temperature Range	-55 to +150	$^{\circ}\text{C}$
T_{STG}	Storage Temperature Range	-55 to +150	$^{\circ}\text{C}$
$R_{\theta JA}$	Thermal Resistance-Junction to Ambient	62	$^{\circ}\text{C}/\text{W}$
$R_{\theta JC}$	Thermal Resistance-Junction to Case	2.8	$^{\circ}\text{C}/\text{W}$

Electrical Characteristics

T_A=25°C Unless otherwise noted

Symbol	Parameter	Conditions	Min	Typ	Max	Unit
Static						
V _{(BR)DSS}	Drain-Source Breakdown Voltage	V _{GS} =0V, I _D =250uA	30			V
ΔBV _{DSS} /ΔT _J	BV _{DSS} Temperature Coefficient	Reference to 25°C, I _D =1mA		0.04		V/°C
V _{GS(th)}	Gate Threshold Voltage	V _{DS} =V _{GS} , I _D =250uA	1.2	1.6	2.5	V
ΔV _{GS(th)}	V _{GS(th)} Temperature Coefficient			-4		mV/°C
I _{GSS}	Gate Leakage Current	V _{DS} =0V, V _{GS} =±20V			±100	nA
I _{DSS}	Zero Gate Voltage Drain Current	V _{DS} =30V, V _{GS} =0V			1	uA
		V _{DS} =24V, V _{GS} =0V, T _J =125°C			10	
I _S	Continuous Source Current	V _G =V _D =0V, Force Current			60	A
I _{SM}	Pulsed Source Current				240	
R _{DS(on)}	Drain-Source On-Resistance	V _{GS} =10V, I _D =20A		4.8	6	mΩ
		V _{GS} =4.5V, I _D =10A		6.7	9	
g _{FS}	Forward Transconductance	V _{DS} =10V, I _D =10A		23		S
V _{SD}	Diode Forward Voltage	V _{GS} =0V, I _S =1A			1	V
EAS	Single Pulse Avalanche Energy	V _{DD} =25V, L=0.1mH, IAS=20A	20			mJ
Dynamic						
Q _g	Total Gate Charge	V _{DS} =15V, V _{GS} =4.5V, I _D =20A		11.1	18	nC
Q _{gs}	Gate-Source Charge			1.85	3.8	
Q _{gd}	Gate-Drain Charge			6.8	12	
C _{iss}	Input Capacitance	V _{DS} =25V, V _{GS} =0V, f=1MHz		1210	1800	pF
C _{oss}	Output Capacitance			190	280	
C _{rss}	Reverse Transfer Capacitance			100	150	
t _{d(on)}	Turn-On Time	V _{DD} =15V, I _D =15A, V _{GS} =10V, R _G =3.3Ω		7.5	14	ns
t _r				14.5	28	
t _{d(off)}	Turn-Off Time			35.2	67	
t _f				9.6	18	
R _g	Gate Resistance		V _{GS} =0V, V _{DS} =0V, f=1MHz		2.5	

Typical Performance Characteristics

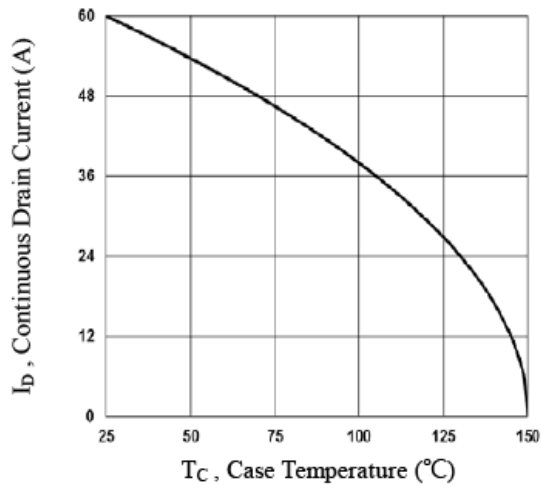

Fig.1 Continuous Drain Current vs. T_c

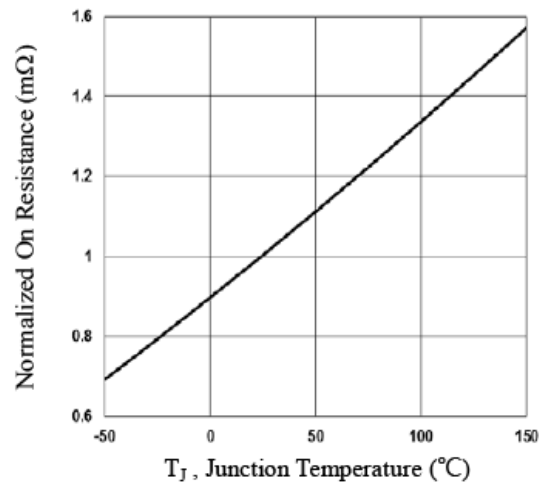

Fig.2 Normalized $R_{DS(on)}$ vs. T_j

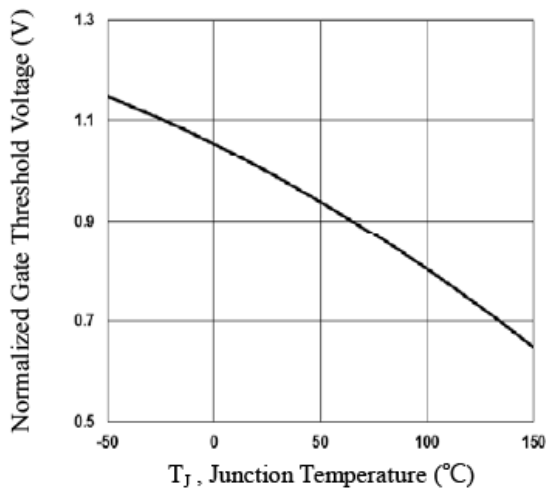

Fig.3 Normalized V_{th} vs. T_j

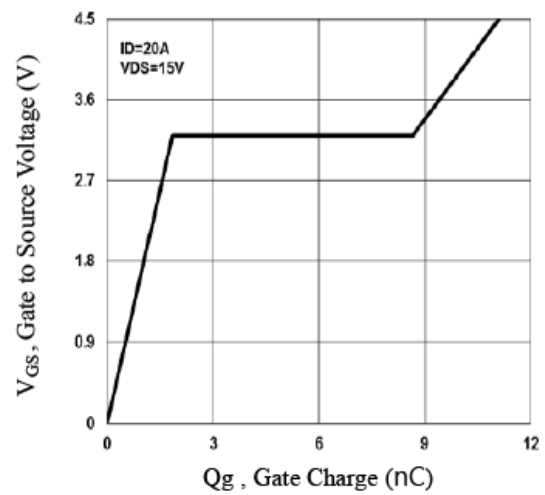

Fig.4 Gate Charge Waveform

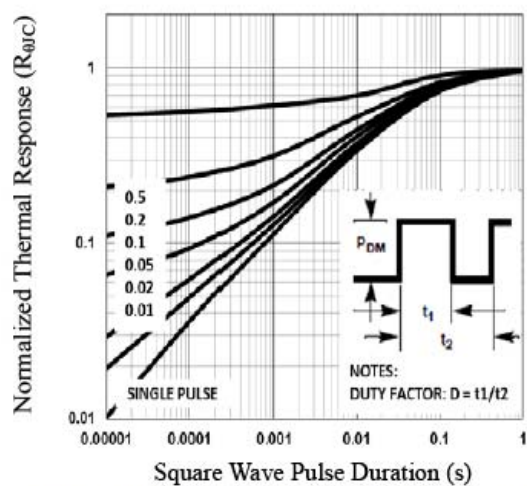

Fig.5 Normalized Transient Impedance

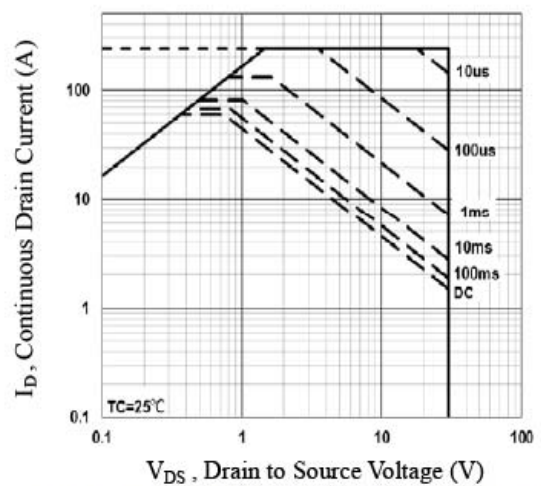
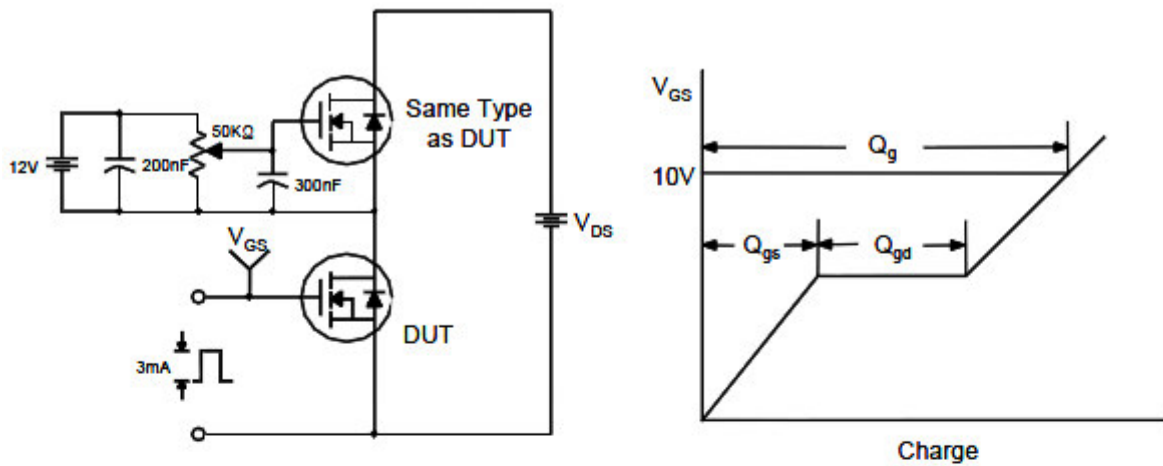

Fig.6 Maximum Safe Operation Area

Typical Performance Characteristics (Continue)

Gate Charge Test Circuit & Waveform



Resistive Switching Test Circuit & Waveforms

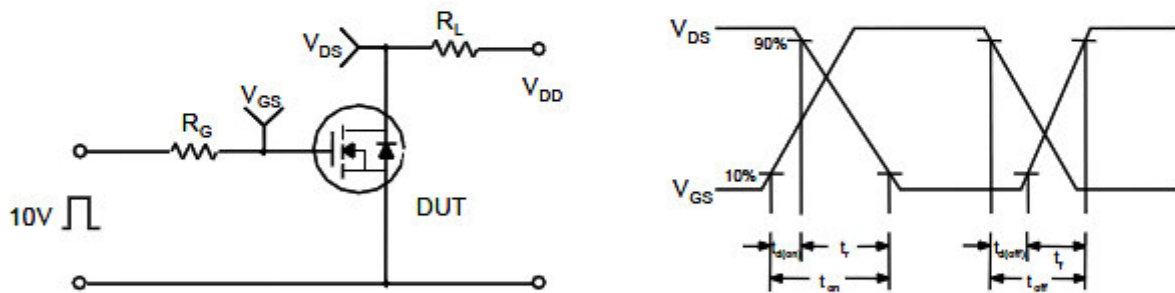

Unclamped Inductive Switching Test Circuit & Waveforms

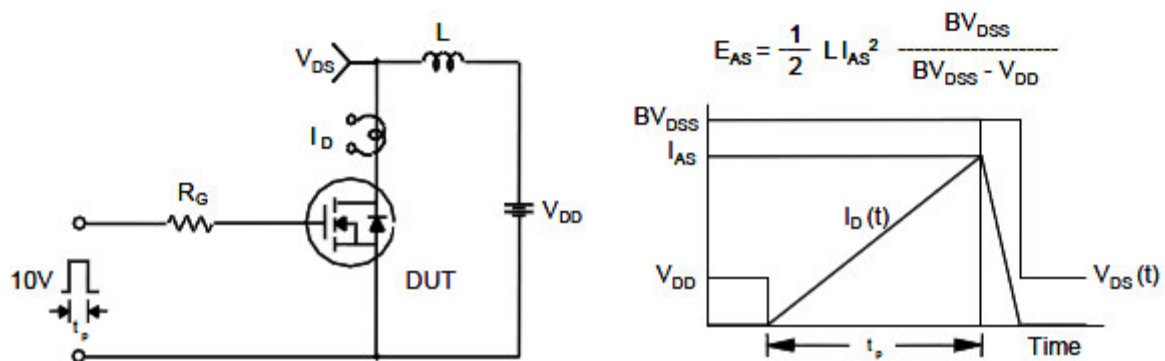

Package Dimension

DFN3X3-8L

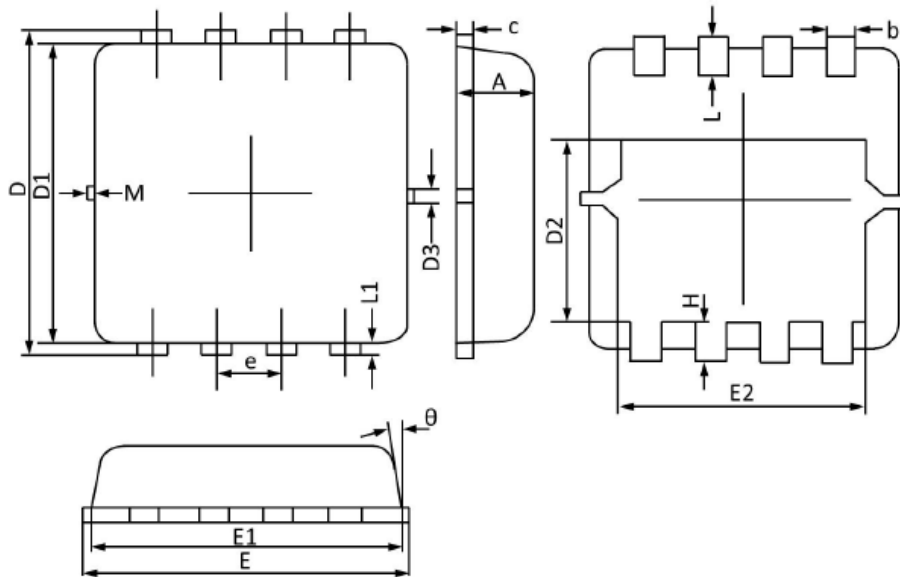

Dimensions

Symbol	Millimeters		Inches	
	Min	Max	Min	Max
A	0.700	0.800	0.028	0.031
b	0.250	0.350	0.010	0.013
c	0.100	0.250	0.004	0.009
D	3.250	3.450	0.128	0.135
D1	3.000	3.200	0.119	0.125
D2	1.780	1.980	0.070	0.077
D3	0.130 (REF)		0.005 (REF)	
E	3.200	3.400	0.126	0.133
E1	3.000	3.200	0.119	0.125
E2	2.390	2.590	0.094	0.102
e	0.650 (BSC)		0.026 (BSC)	
H	0.300	0.500	0.011	0.019
L	0.300	0.500	0.011	0.019
L1	0.130 (REF)		0.005 (REF)	
θ	0°	12°	0°	12°
M	0.150 (REF)		0.006 (REF)	

NOTICE

Information furnished is believed to be accurate and reliable. However Globaltech Semiconductor assumes no responsibility for the consequences of use of such information nor for any infringement of patents or other rights of third parties, which may result from its use. No license is granted by implication or otherwise under any patent or patent rights of Globaltech Semiconductor. Specifications mentioned in this publication are subject to change without notice. This publication supersedes and replaces all information without express written approval of Globaltech Semiconductor.

CONTACT US

GS Headquarter	
	4F.,No.43-1,Lane11,Sec.6,Minquan E.Rd Neihu District Taipei City 114, Taiwan (R.O.C)
	886-2-2657-9980
	886-2-2657-3630
	sales_twn@gs-power.com

Shenzhen Branch(China)	
	1113 B Building, Happiness Washington, Baoan Nan Road, Luohu District, Shenzhen City, China
	0755-22208941
	sales_cn@gs-power.com

RD Division	
	824 Bolton Drive Milpitas. CA. 95035
	1-408-457-0587