

## GSP202U

**SURFACE MOUNT, SWITCHING DIODE**  
**VOLTAGE 80V, CURRENT 0.1A**

### Description

The GSP202U is designed for ultra high speed switching.

### Package Dimensions

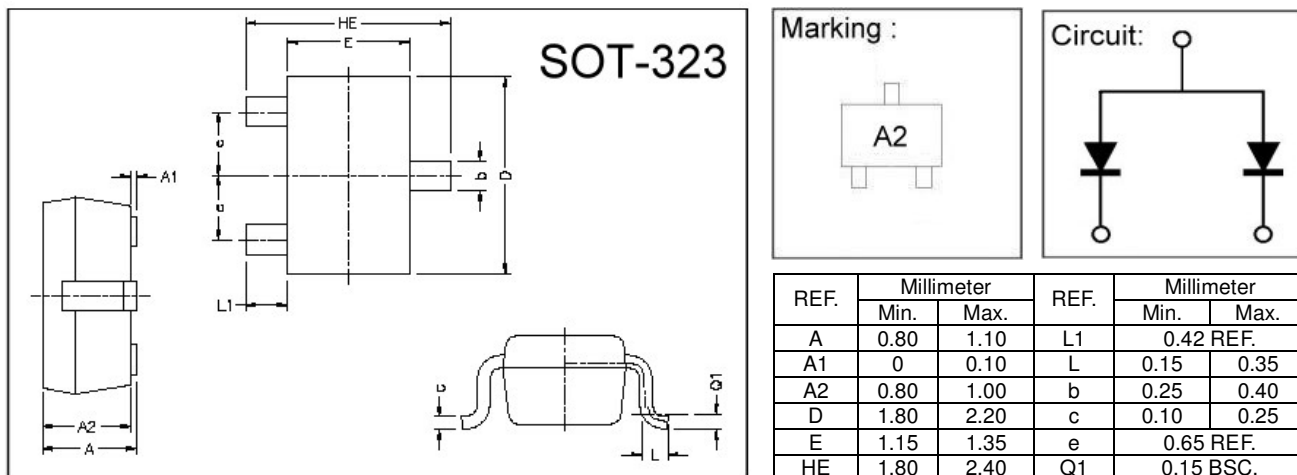

### Absolute Maximum Ratings at Ta = 25°C

Parameter	Symbol	Ratings	Unit
Junction Temperature	T <sub>J</sub>	+150	°C
Storage Temperature	T <sub>stg</sub>	-55 ~ +150	°C
Maximum Peak Repetitive Reverse Voltage	V <sub>RRM</sub>	80	V
Maximum RMS Voltage	V <sub>RMS</sub>	56	V
Maximum DC Blocking Voltage	V <sub>DC</sub>	80	V
Peak Forward Surge Current at 1uSec	I <sub>FSM</sub>	4.0	A
Typical Junction Capacitance between Terminal (Note 1)	C <sub>J</sub>	3.5	pF
Maximum Reverse Recovery Time(Note 2)	T <sub>RR</sub>	4.0	nSec
Maximum Average Forward Rectified Current	I <sub>o</sub>	0.1	A
Total Power Dissipation	PD	225	mW

### Characteristics at Ta = 25°C

Characteristics	Symbol	Typ.	Unit	Test Condition
Maximum Instantaneous Forward Voltage	V <sub>F</sub>	1.20	V	I <sub>F</sub> = 100mA
Maximum Average Reverse Current	I <sub>R</sub>	0.1	uA	V <sub>R</sub> = 70V

Notes: 1. Measured at 1.0 MHz and applied reverse voltage of 6.0 volt.

2. Measured at applied forward current of 5mA and reverse voltage of 6.0 volt.

3. ESD sensitive product handling required.

## Characteristics Curve

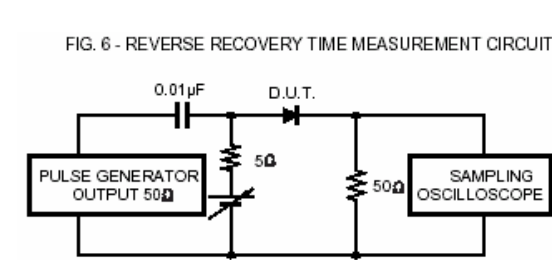
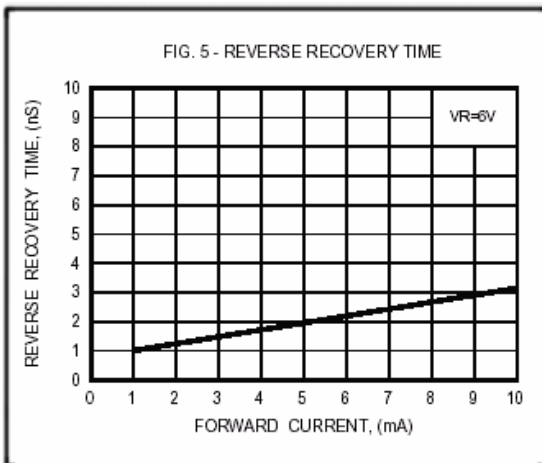
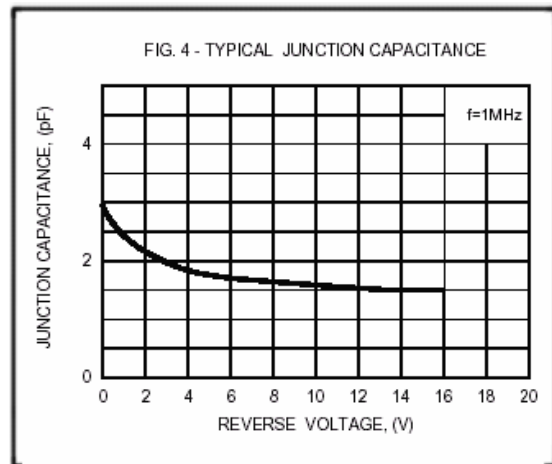
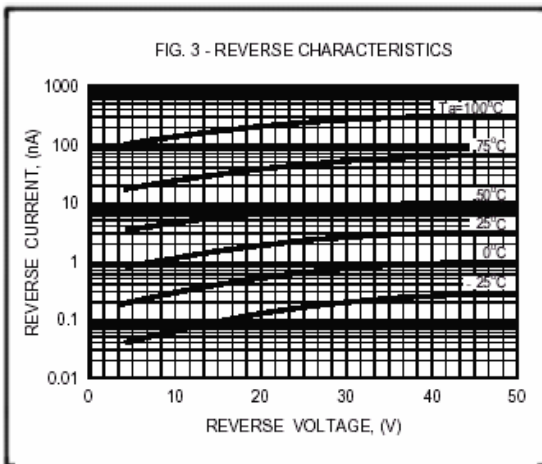
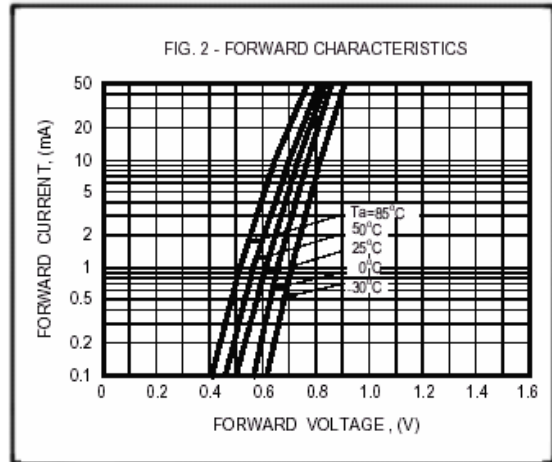
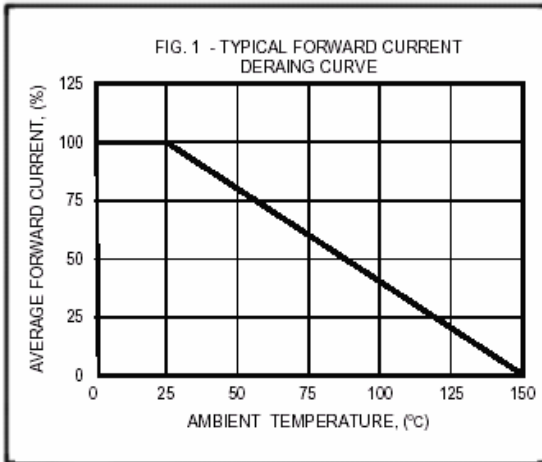

**Important Notice:**

- All rights are reserved. Reproduction in whole or in part is prohibited without the prior written approval of GTM.
- GTM reserves the right to make changes to its products without notice.
- GTM semiconductor products are not warranted to be suitable for use in life-support Applications, or systems.
- GTM assumes no liability for any consequence of customer product design, infringement of patents, or application assistance.

**Head Office And Factory:**

- Taiwan:** No. 17-1 Tatung Rd. Fu Kou Hsin-Chu Industrial Park, Hsin-Chu, Taiwan, R. O. C.
- TEL : 886-3-597-7061 FAX : 886-3-597-9220, 597-0785
- China:** (201203) No.255, Jang-Jiang Tsai-Lueng RD. , Pu-Dung-Hsin District, Shang-Hai City, China
- TEL : 86-21-5895-7671 ~ 4 FAX : 86-21-38950165