

Features

- Forward current (Io=100mA)
- Low reverse current
- Low forward voltage drop
- Leadless ultra small SMD plastic package

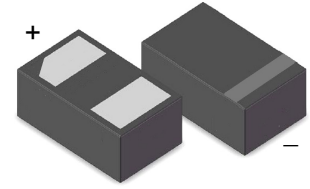

DFN0603-X4

Applications

- Low voltage rectification
- High efficiency DC-to-DC conversion
- Switch Mode Power Supply (SMPS)
- Reverse polarity protection
- Low power consumption applications

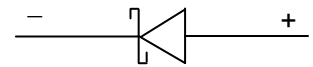

Schematic Diagram

Absolute Maximum Ratings (T_A=25°C unless otherwise noted)

Parameter	Symbol	Value	Unit
Peak Repetitive Peak Reverse Voltage	V _{RRM}	30	V
Working Peak Reverse Voltage	V _{RWM}		
RMS Reverse Voltage	V _{R(RMS)}	21	V
Forward Continuous Current	I _F	100	mA
Non-repetitive Peak Forward Surge Current @ t=8.3ms	I _{FSM}	0.5	A
Power Dissipation	P _D	100	mW
Thermal Resistance from Junction to Ambient	R _{θJA}	1000	°C/W
Junction Temperature	T _J	125	°C
Storage Temperature	T _{STG}	-55 to +150	°C

Electrical Characteristics (T_A=25°C unless otherwise noted)

Parameter	Symbol	Test Condition	Min	Typ	Max	Unit
Reverse Breakdown Voltage	V _(BR)	I _R =50μA	30	-	-	V
Reverse Current	I _R	V _R =10V	-	-	10	μA
		V _R =30V	-	-	50	μA
Forward Voltage	V _F	I _F =10mA	-	-	0.38	V
		I _F =100mA	-	-	0.60	V

Typical Characteristics Curves

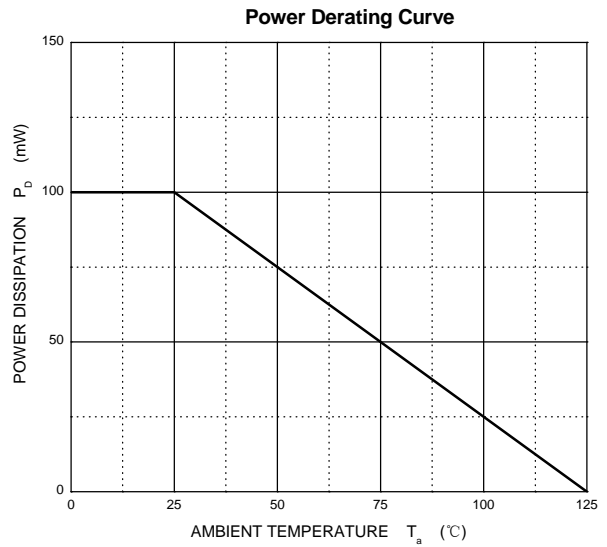
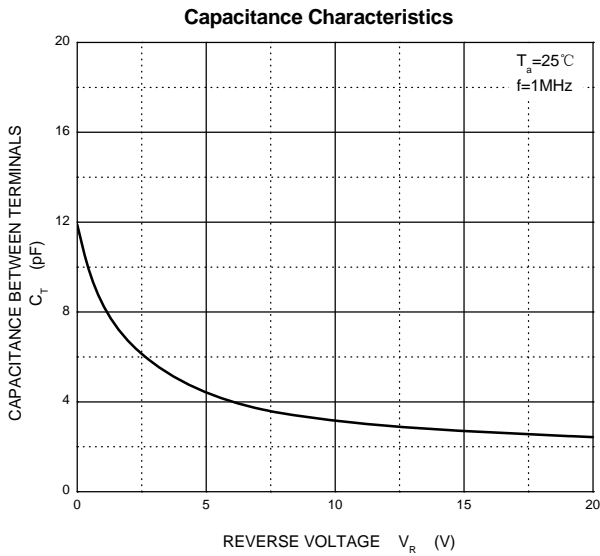
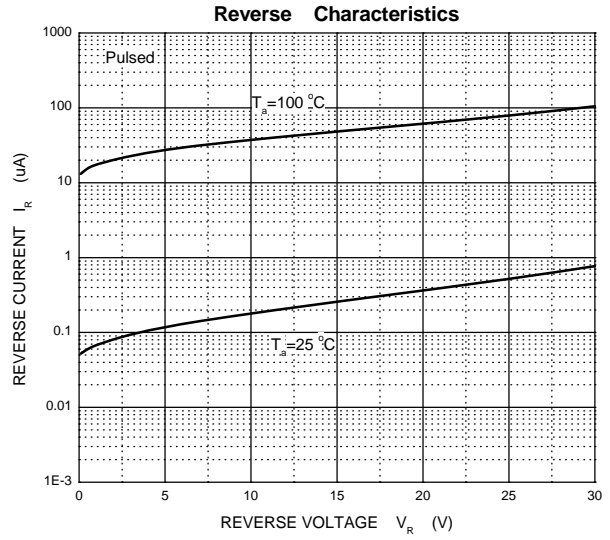
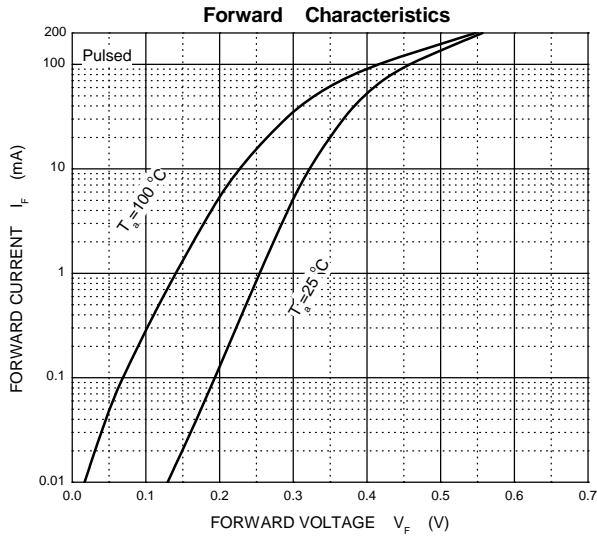

Package Outline Dimensions DFN0603-X4

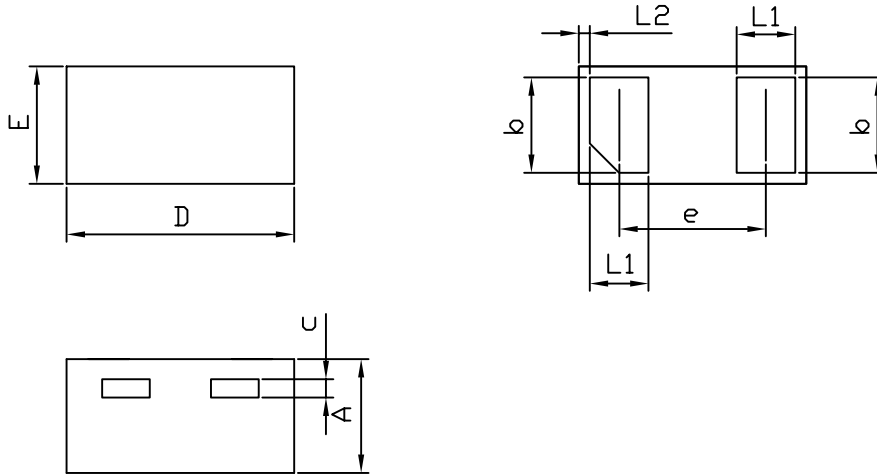

Symbol	Dimensions In Millimeters		Dimensions In Inches	
	Min.	Max.	Min.	Max.
A	0.275	0.340	0.011	0.013
D	0.570	0.670	0.022	0.026
E	0.270	0.370	0.011	0.015
b	0.225	0.295	0.009	0.012
c	0.050 REF.		0.002 REF.	
e	0.365	0.435	0.014	0.017
L1	0.125	0.195	0.005	0.008
L2	0.030 REF.		0.001 REF.	

Suggested Pad Layout

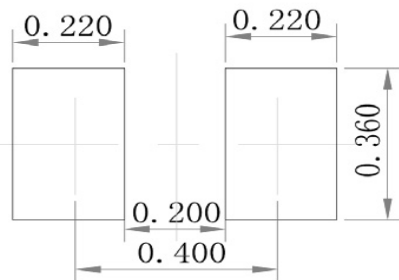

Note:
 1. Controlling dimension: in millimeters.
 2. General tolerance: ± 0.050 mm.
 3. The pad layout is for reference purposes only.

Marking and Ordering Information

Device	Package	Marking	Quantity	HSF Status
GSRB521F-30	DFN0603	F	10,000pcs / Reel	RoHS Compliant