

GSTMMBT2222A

NPN General Purpose Transistors

Product Description

This device is designed as a general purpose amplifier and switch.

Features

- Lead(Pb)-Free

Packages & Pin Assignments

GSTMMBT2222AF(SOT-23)	
	
Pin	Description
1	Base
2	Emitter
3	Collector

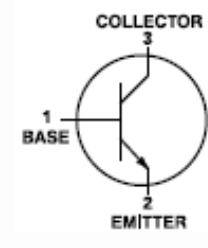

Marking Information

P/N	Package	Part Marking
GSTMMBT2222AF	SOT-23	1P

Ordering Information

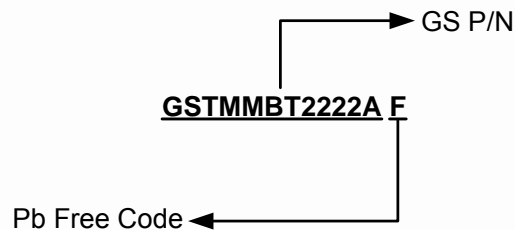

Part Number	Package	Quantity
GSTMMBT2222AF	SOT-23	3000 PCS

Absolute Maximum Ratings

$T_A=25^\circ\text{C}$

Symbol	Conditions	Typical	Unit
V_{CEO}	Collector-Emitter Voltage	40	V
V_{CBO}	Collector-Base Voltage	75	V
V_{EBO}	Emitter-Base Voltage	6.0	V
$I_{C(DC)}$	Collector Current (DC)	600	mA
P_D	Total Device Dissipation FR-5 Board (1) $T_A=25^\circ\text{C}$	225	mW
	Derate above 25°C	1.8	mW/ $^\circ\text{C}$
$R_{\theta JA}$	Thermal Resistance Junction to Ambient	556	$^\circ\text{C}/\text{W}$
P_D	Total Device Dissipation Alumina Substrate (2) $T_A=25^\circ\text{C}$	300	mW
	Derate above 25°C	2.4	mW/ $^\circ\text{C}$
$R_{\theta JA}$	Thermal Resistance Junction to Ambient	417	$^\circ\text{C}/\text{W}$
T_J	Junction Temperature Range	-55 to +150	$^\circ\text{C}$
T_{STG}	Storage Temperature Range	-55 to +150	$^\circ\text{C}$

Note 1: FR-5=1.0 x 0.75 x 0.062 in

Note 2: Alumina=0.4 x 0.3 x 0.024in, 99.5% alumina

Electrical Characteristics

($T_A=25^\circ\text{C}$ unless otherwise noted)

Symbol	Conditions	Min	Max	Unit
$V_{(BR)CEO}$	Collector-Emitter Breakdown Voltage ($I_C=10\text{mA}$, $I_B=0\text{mA}$)	40	-	V
$V_{(BR)CBO}$	Collector-Base Breakdown Voltage ($I_C=10\mu\text{A}$, $I_E=0\text{mA}$)	75	-	V
$V_{(BR)EBO}$	Emitter-Base Breakdown Voltage ($I_E=10\mu\text{A}$, $I_C=0\text{mA}$)	6.0	-	V
I_{CEO}	Collector Cutoff Current ($V_{CE}=60\text{V}$, $V_{EB(off)}=3.0\text{V}$)	-	10	nA
I_{CBO}	Collector Cutoff Current ($V_{CB}=60\text{V}$, $I_E=0\text{mA}$) ($V_{CB}=60\text{V}$, $I_E=0\text{mA}$, $T_A=125^\circ\text{C}$)	-	0.01 10	μA
I_{EBO}	Emitter Cutoff Current ($V_{EB}=3.0\text{V}$, $I_C=0\text{mA}$)	-	100	nA
I_{BL}	Base Cutoff Current ($V_{CE}=60\text{V}$, $V_{EB(off)}=3.0\text{V}$)	-	20	nA
h_{FE}	DC Current Gain ($I_C=0.1\text{mA}$, $V_{CE}=10\text{V}$)	35	-	-
	DC Current Gain ($I_C=1.0\text{mA}$, $V_{CE}=10\text{V}$)	50	-	-
	DC Current Gain ($I_C=10\text{mA}$, $V_{CE}=10\text{V}$)	75	-	-
	DC Current Gain ($I_C=10\text{mA}$, $V_{CE}=10\text{V}$, $T_A=-55^\circ\text{C}$)	35	-	-
	DC Current Gain ($I_C=150\text{mA}$, $V_{CE}=10\text{V}$) (3)	100	300	-
	DC Current Gain ($I_C=150\text{mA}$, $V_{CE}=1.0\text{V}$) (3)	50	-	-
	DC Current Gain ($I_C=500\text{mA}$, $V_{CE}=10\text{V}$) (3)	40	-	-

Electrical Characteristics (Continue)

(T_A=25°C unless otherwise noted)

Symbol	Conditions	Min	Max	Unit
V _{CE(sat)}	Collector-Emitter Saturation Voltage (3) (I _C =150mA, I _B =15mA) (I _C =500mA, I _B =50mA)	- -	0.3 1.0	V
V _{BE(sat)}	Base-Emitter Saturation Voltage (3) (I _C =150mA, I _B =15mA) (I _C =500mA, I _B =50mA)	0.6 -	1.2 2.0	V
f _T	Current-Gain-Bandwidth Product (4) (I _C =20mA, V _{CE} =20V, f=100MHz)	300	-	MHz
C _{obo}	Output Capacitance (V _{CB} =10V, I _E =0mA, f=1.0MHz)	-	8.0	pF
C _{ibo}	Input Capacitance (V _{EB} =0.5V, I _C =0mA, f=1.0MHz)	-	25	pF
h _{ie}	Input Impedance (I _C =1.0mA, V _{CE} =10V, f=1.0 kHz) (I _C =10mA, V _{CE} =10V, f=1.0 kHz)	2.0 0.25	8.0 1.25	KΩ
h _{re}	Voltage Feedback Ratio (I _C =1.0mA, V _{CE} =10V, f=1.0 kHz) (I _C =10mA, V _{CE} =10V, f=1.0 kHz)	- -	8.0 4.0	x10 ⁻⁴
h _{fe}	Small-Signal Current Gain (I _C =1.0mA, V _{CE} =10V, f=1.0 kHz) (I _C =10mA, V _{CE} =10V, f=1.0 kHz)	50 75	300 375	-
h _{oe}	Output Admittance (I _C =1.0mA, V _{CE} =10V, f=1.0kHz) (I _C =10mA, V _{CE} =10V, f=1.0kHz)	5.0 25	35 200	umhos
r _b , C _c	Collector Base Time Constant (I _E =20mA, V _{CB} =20V, f=31.8 MHz)	-	150	ps
NF	Noise Figure (I _C =100μA, V _{CE} =10V, R _S =1.0kΩ, f=1.0kHz)	-	4.0	dB
t _d	Delay Time (V _{CC} =30V, V _{BE(off)} =-0.5V, I _C =150mA, I _{B1} =15mA)	-	10	ns
t _r	Rise Time (V _{CC} =30V, V _{BE(off)} =-0.5V, I _C =150mA, I _{B1} =15mA)	-	25	ns
t _s	Storage Time (V _{CC} =30V, I _C =150mA, I _{B1} =I _{B2} =15mA)	-	225	ns
t _f	Fall Time (V _{CC} =30V, I _C =150mA, I _{B1} =I _{B2} =15mA)	-	60	ns

Note 3: Pulse Test: Pulse Width ≤ 300 us, Duty Cycle ≤ 2.0%

Note 4: f_T is defined as the frequency at which h_{fe} extrapolates to unity

Typical Application Circuit

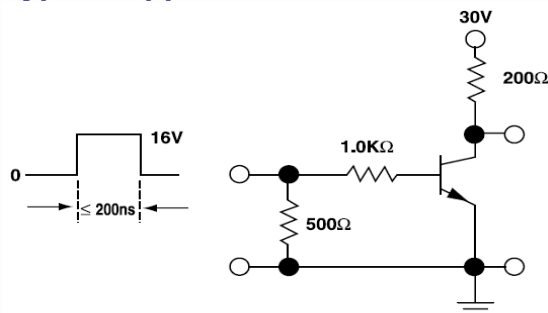

FIGURT 1: Saturated Turn-On Switching Time

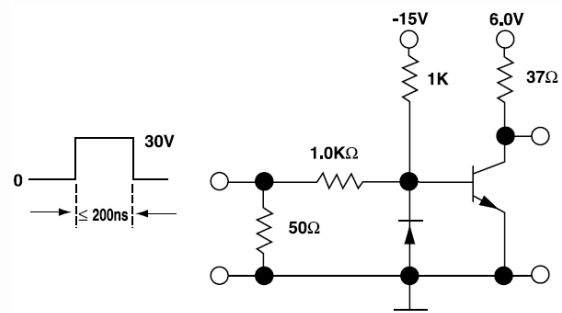

FIGURT 2: Saturated Turn-Off Switching Time

Typical Performance Characteristics

Typical Pulsed Current Gain vs Collector Current

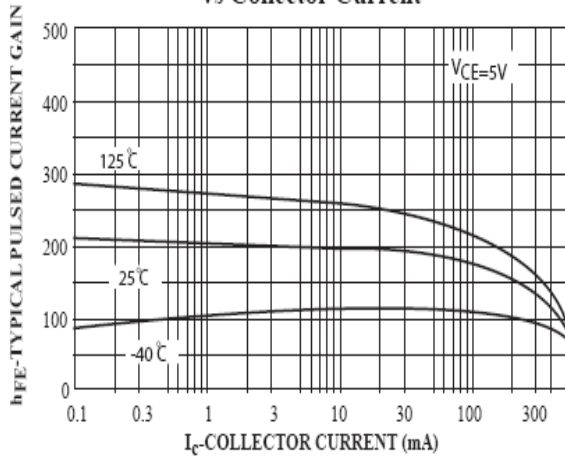

Collector- Emitter Saturation Voltage vs Collector Current

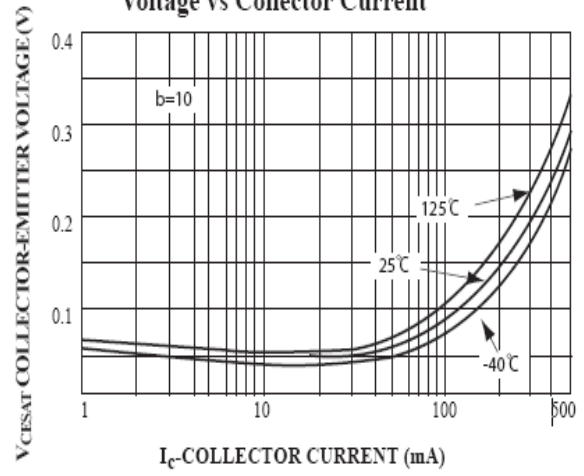

Base-Emitter Saturation Voltage vs Collector Current

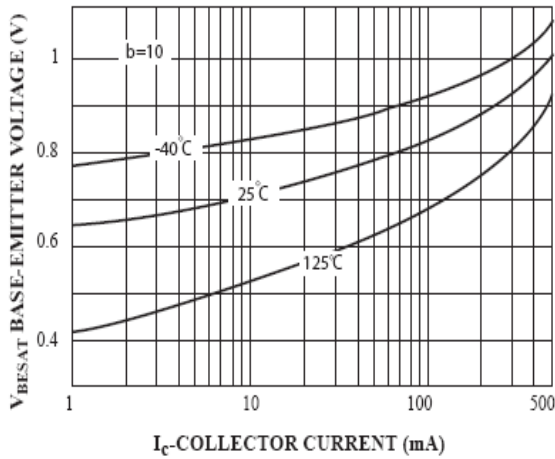

Base-Emitter ON Voltage vs Collector Current

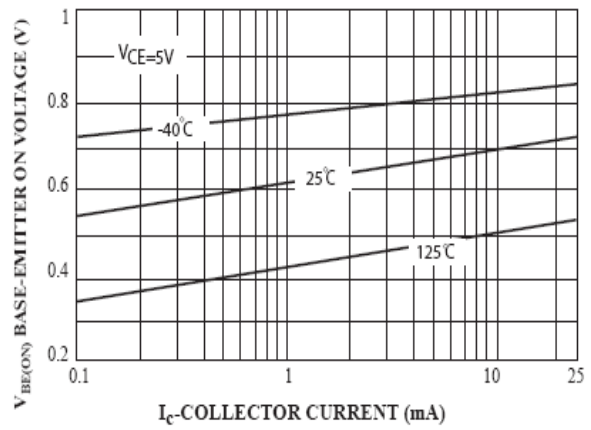

Collector-Cutoff Current vs Ambient Temperature

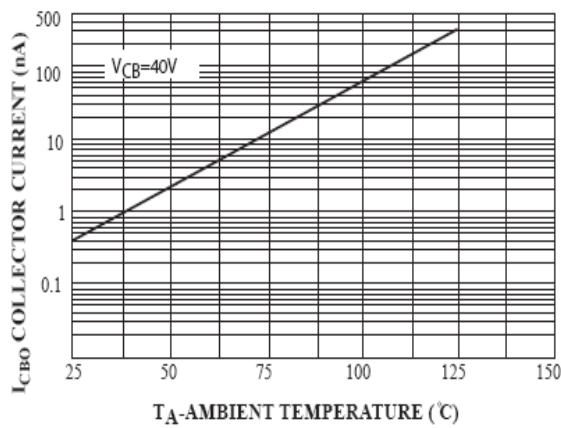

Emitter Transition and Output Capacitance vs Reverse Bias Voltage

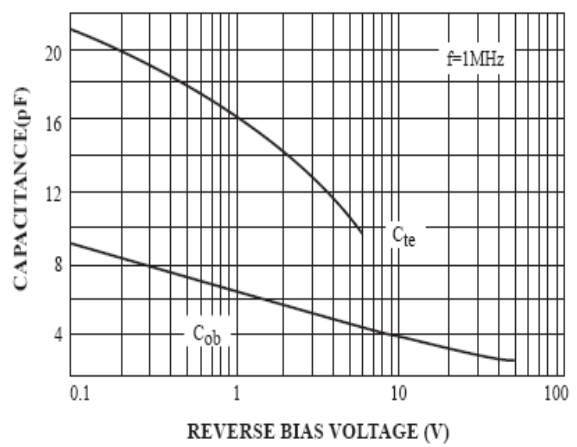

Typical Performance Characteristics (Continue)

Turn On and Turn Off Times vs Collector Current

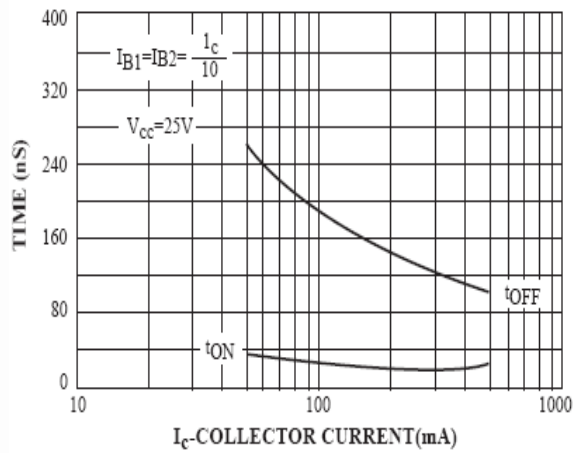

Switching Times vs Collector Current

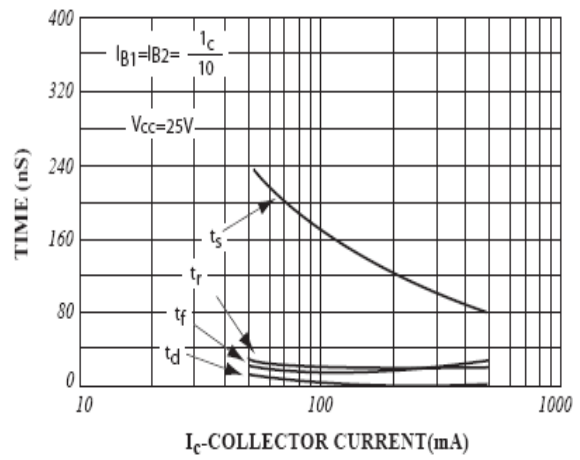

Power Dissipation vs Ambient Temperature

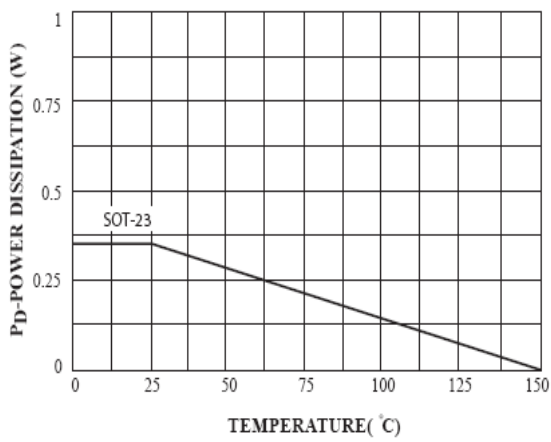

Package Dimension

SOT-23

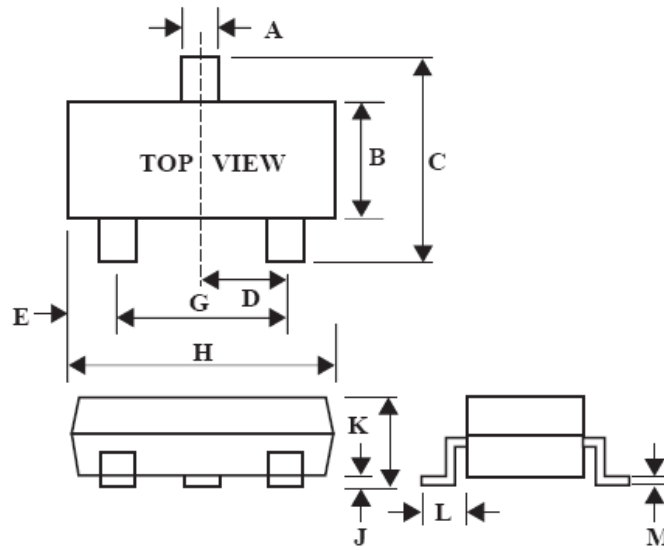



Dimensions				
Symbol	Millimeters		Inches	
	Min	Max	Min	Max
A	0.35	0.51	0.014	0.020
B	1.19	1.40	0.047	0.055
C	2.10	3.00	0.083	0.118
D	0.85	1.05	0.033	0.041
E	0.46	1.00	0.018	0.039
G	1.70	2.10	0.067	0.083
H	2.70	3.10	0.106	0.122
J	0.01	0.13	0.000	0.005
K	0.89	1.10	0.035	0.043
L	0.30	0.61	0.011	0.024
M	0.076	0.25	0.002	0.010



NOTICE

Information furnished is believed to be accurate and reliable. However Globaltech Semiconductor assumes no responsibility for the consequences of use of such information nor for any infringement of patents or other rights of third parties, which may result from its use. No license is granted by implication or otherwise under any patent or patent rights of Globaltech Semiconductor. Specifications mentioned in this publication are subject to change without notice. This publication supersedes and replaces all information without express written approval of Globaltech Semiconductor.

CONTACT US

GS Headquarter	
	4F.,No.43-1,Lane11,Sec.6,Minquan E.Rd NeiHu District Taipei City 114, Taiwan (R.O.C)
	886-2-2657-9980
	886-2-2657-3630
	sales_twn@gs-power.com

Wu-Xi Branch	
	No.21 Changjiang Rd., WND, Wuxi, Jiangsu, China (INFO. & TECH. Science Park Building A 210 Room)
	86-510-85217051
	86-510-85211238
	sales_cn@gs-power.com

RD Division	
	824 Bolton Drive Milpitas. CA. 95035
	1-408-457-0587