

Description

The GT1003B uses advanced trench technology and design to provide excellent $R_{DS(ON)}$, low gate charge. This device is suitable for use in high frequency Synchronous-recification application.

General Features

| | | |
|-----------|-----------------------------|-------|
| V_{DSS} | $R_{DS(ON)}$ @ 10V (Typ) | I_D |
| 100V | 115m Ω | 7 A |

- High density cell design for ultra low R_{dson}
- Lead free product is acquired
- Excellent package for good heat dissipation
- RoHS Compliant

Application

- Consumer electronic power supply
- Isolated DC/DC converter
- Motor control

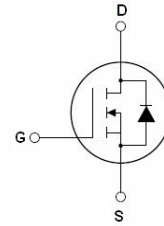

Schematic Diagram

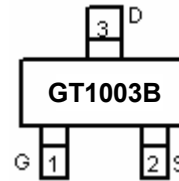

Marking and Pin Assignment



SOT-23

Ordering Information

| Part Number | Marking | Case | Packaging |
|-------------|---------|--------|--------------|
| GT1003B | GT1003B | SOT-23 | 3000pcs/Reel |

Absolute Maximum Ratings (TA=25°C unless otherwise noted)

| Parameter | Symbol | Limit | Unit |
|--------------------------------------------------|----------------|------------|-------------|
| Drain-Source Voltage | V_{DS} | 100 | V |
| Gate-Source Voltage | V_{GS} | ± 20 | V |
| Drain Current-Continuous | I_D | 7 | A |
| Drain Current-Pulsed (Note 1) | I_{DM} | 21 | A |
| Maximum Power Dissipation | P_D | 17 | W |
| Single pulsed avalanche energy (Note 5) | E_{AS} | 1.2 | mJ |
| Operating Junction and Storage Temperature Range | T_J, T_{STG} | -55 To 150 | $^{\circ}C$ |

Thermal Characteristic

| | | | |
|--------------------------------------------------|-----------------|-----|---------------|
| Thermal Resistance, Junction-to-case | $R_{\theta JC}$ | 7.4 | $^{\circ}C/W$ |
| Thermal Resistance, Junction-to-Ambient (Note 2) | $R_{\theta JA}$ | 62 | $^{\circ}C/W$ |

Electrical Characteristics (TA=25°C unless otherwise noted)

| Parameter | Symbol | Condition | Min | Typ | Max | Unit |
|---------------------------------|------------|---------------------------|-----|-----|-----|---------|
| Off Characteristics | | | | | | |
| Drain-Source Breakdown Voltage | BV_{DSS} | $V_{GS}=0V, I_D=250\mu A$ | 100 | 110 | - | V |
| Zero Gate Voltage Drain Current | I_{DSS} | $V_{DS}=100V, V_{GS}=0V$ | - | - | 1 | μA |

| | | | | | | |
|-------------------------------------------|---------------|-------------------------------------------------------|---|------|-----------|------------|
| Gate-Body Leakage Current | I_{GSS} | $V_{GS}=\pm 20V, V_{DS}=0V$ | - | - | ± 100 | nA |
| On Characteristics (Note 3) | | | | | | |
| Gate Threshold Voltage | $V_{GS(th)}$ | $V_{DS}=V_{GS}, I_D=250\mu A$ | 1 | 1.95 | 3 | V |
| Drain-Source On-State Resistance | $R_{DS(ON)}$ | $V_{GS}=10V, I_D=3.5A$ | - | 115 | 140 | m Ω |
| Dynamic Characteristics (Note4) | | | | | | |
| Input Capacitance | C_{iss} | $V_{DS}=50V, V_{GS}=0V,$ $F=1.0MHz$ | - | 206 | - | PF |
| Output Capacitance | C_{oss} | | - | 28.9 | - | PF |
| Reverse Transfer Capacitance | C_{rss} | | - | 1.4 | - | PF |
| Switching Characteristics (Note 4) | | | | | | |
| Turn-on Delay Time | $t_{d(on)}$ | $V_{DD}=50V, I_D=5A$ $V_{GS}=10V, R_{GEN}=2\Omega$ | - | 14.7 | - | ns |
| Turn-on Rise Time | t_r | | - | 3.5 | - | ns |
| Turn-Off Delay Time | $t_{d(off)}$ | | - | 20.9 | - | ns |
| Turn-Off Fall Time | t_f | | - | 2.7 | - | ns |
| Total Gate Charge | Q_g | $V_{DS}=50V, I_D=5A,$ $V_{GS}=10V$ | - | 4.3 | - | nC |
| Gate-Source Charge | Q_{gs} | | - | 1.5 | - | nC |
| Gate-Drain Charge | Q_{gd} | | - | 1.1 | - | nC |
| Gate plateau voltage | $V_{plateau}$ | | | 5.0 | | V |
| Drain-Source Diode Characteristics | | | | | | |
| Diode Forward Current (Note 2) | I_S | $V_{GS}<V_{th}$ | - | - | 7 | A |
| Pulsed Source Current | I_{SP} | $V_{GS}<V_{th}$ | | | 21 | |
| Diode Forward Voltage (Note 3) | V_{SD} | $V_{GS}=0V, I_S=7A$ | - | - | 1.2 | V |
| Reverse Recovery Time | t_{rr} | $I_F=5A, di_F/dt =$ $100A/\mu s$ | | 32.1 | | nS |
| Reverse Recovery Charge | Q_{rr} | | | 39.4 | | μC |
| Peak Reverse Recovery Current | I_{rrm} | | - | 2.1 | - | A |

Notes:

1. Repetitive Rating: Pulse width limited by maximum junction temperature.
2. Surface Mounted on FR4 Board, $t \leq 10$ sec.
3. Pulse Test: Pulse Width $\leq 300\mu s$, Duty Cycle $\leq 2\%$.
4. Guaranteed by design, not subject to production
5. $V_{DD}=50V, R_G=50\Omega, L=0.3mH$, starting $T_j=25^\circ C$.

Typical Electrical And Thermal Characteristics

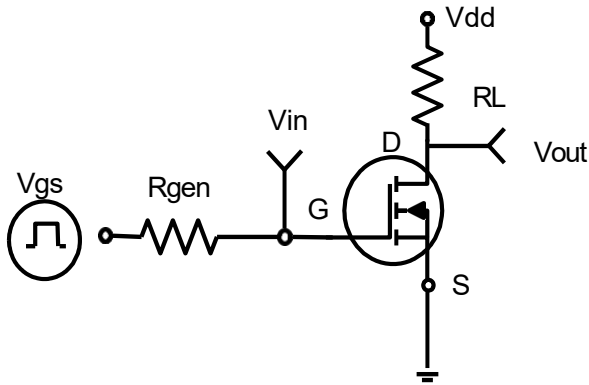

Figure 1. Switching Test Circuit

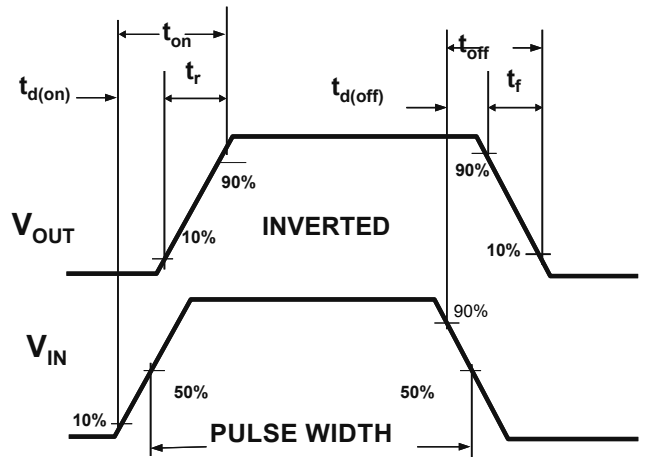

Figure 2. Switching Waveforms

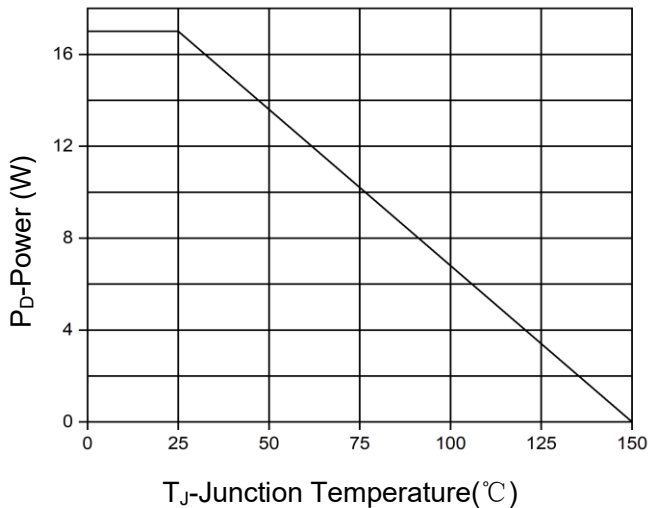

Figure 3. Power Dissipation

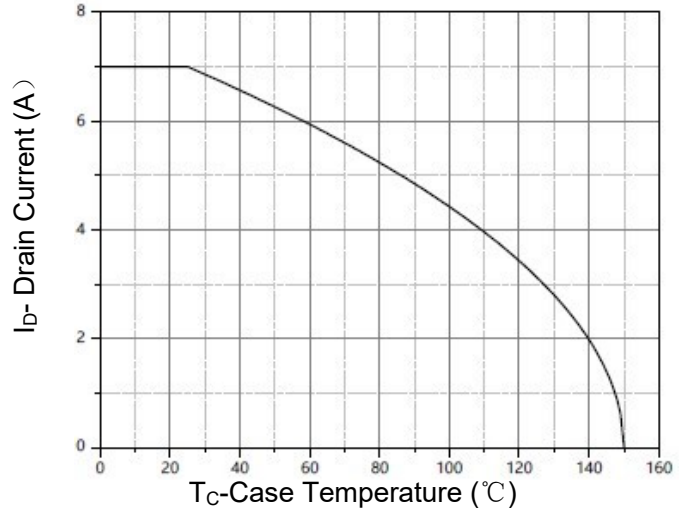

Figure 4. Drain Current

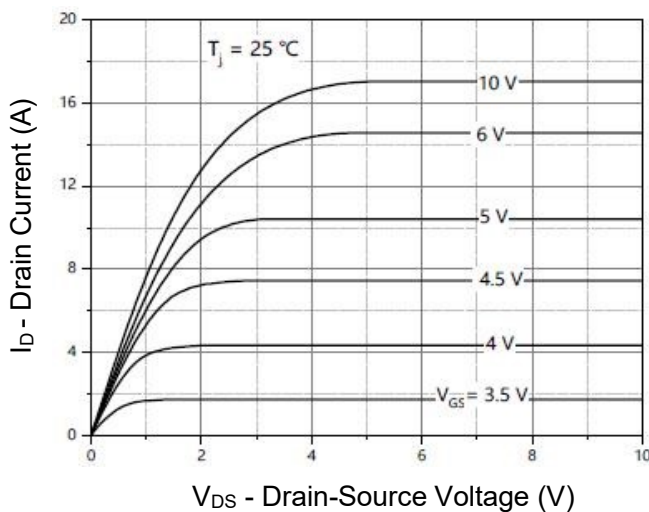

Figure 5. Output characteristics

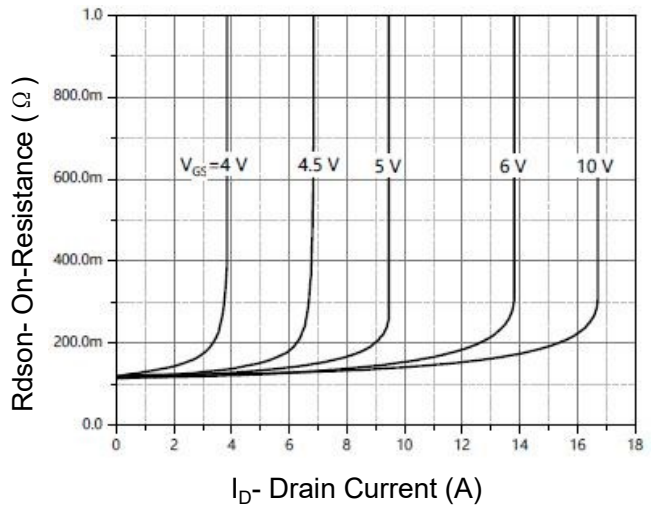

Figure 6. Drain-Source On-state resistance

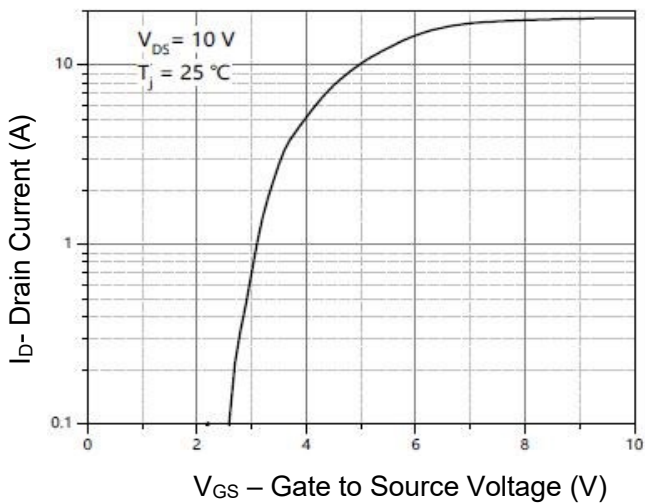

Figure 7. Transfer Characteristics

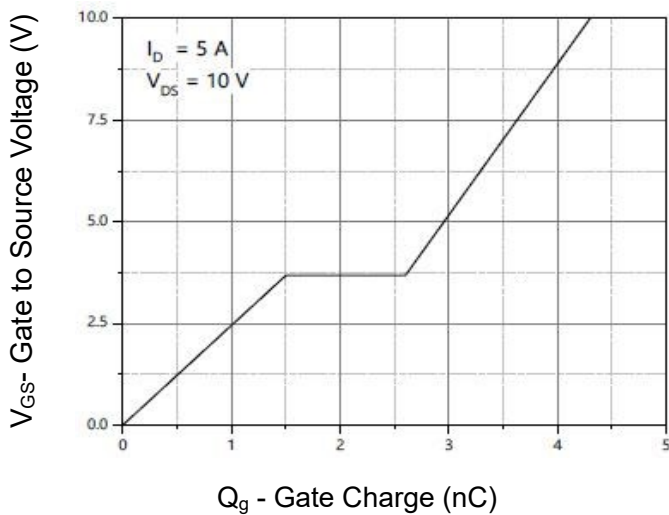

Figure 9. Gate Charge

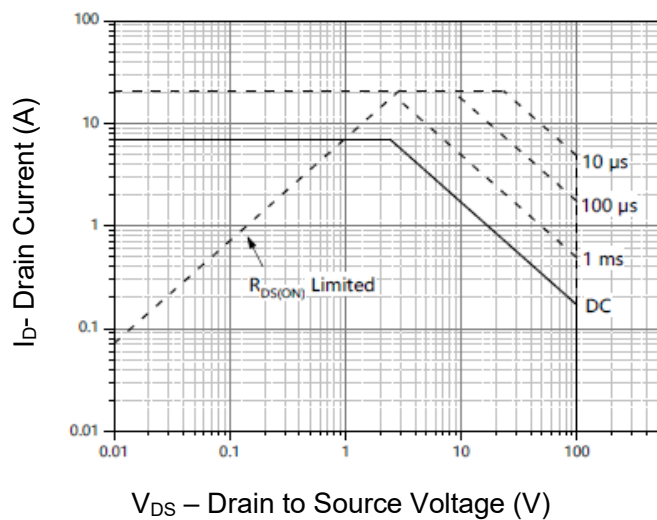

Figure 11. Safe Operation Area

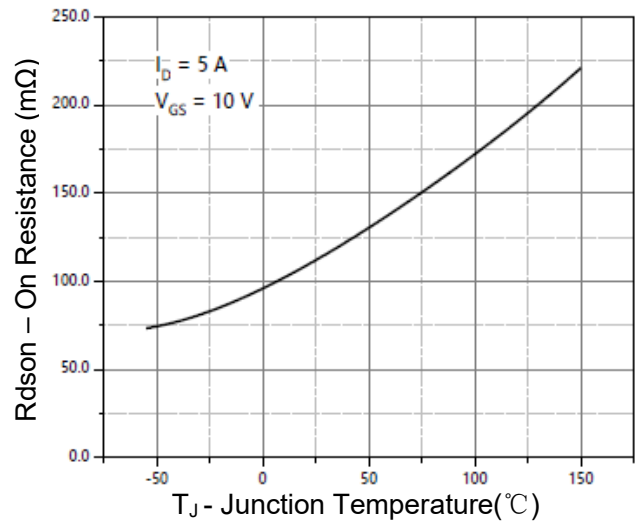

Figure 8. Drain-Source On-State Resistance

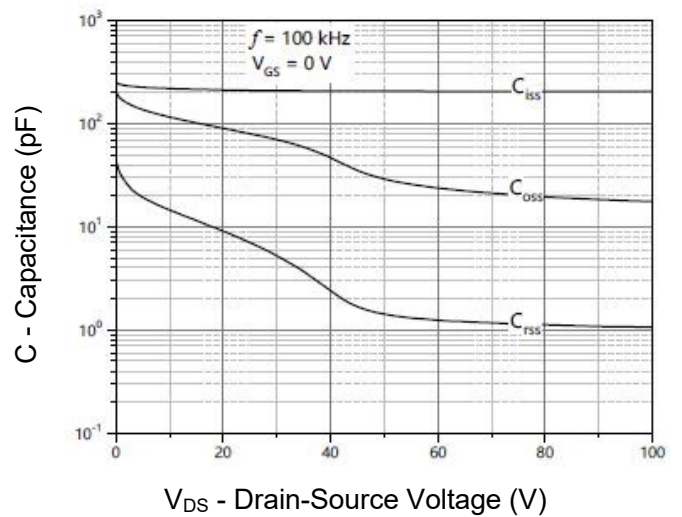

Figure 10. Capacitance vs Vds

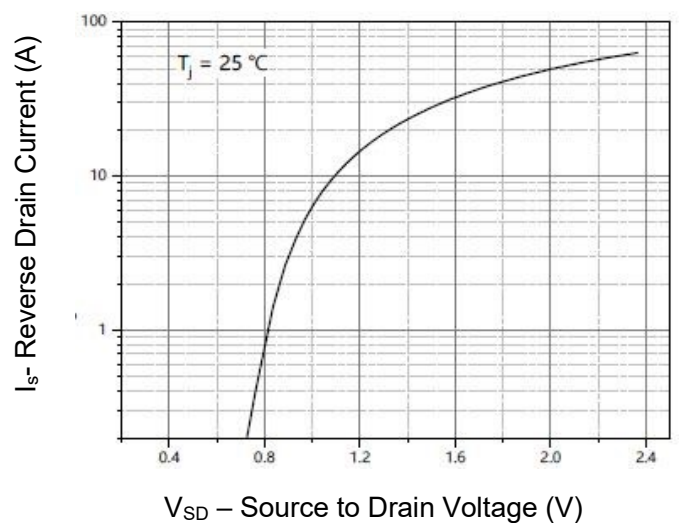

Figure 12. Source- Drain Diode Forward

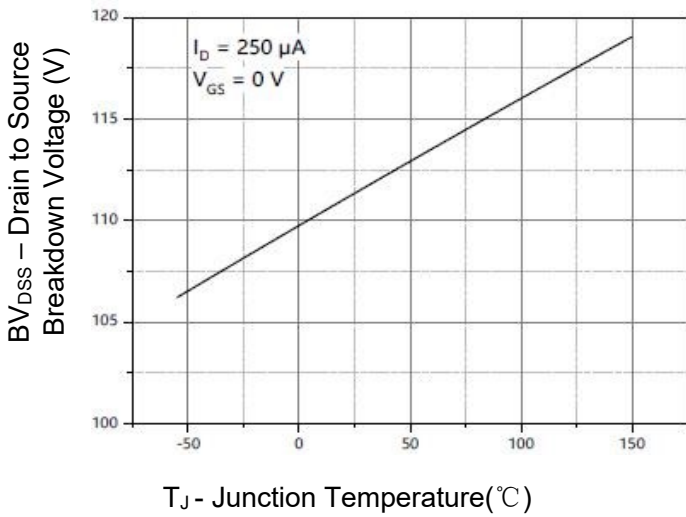
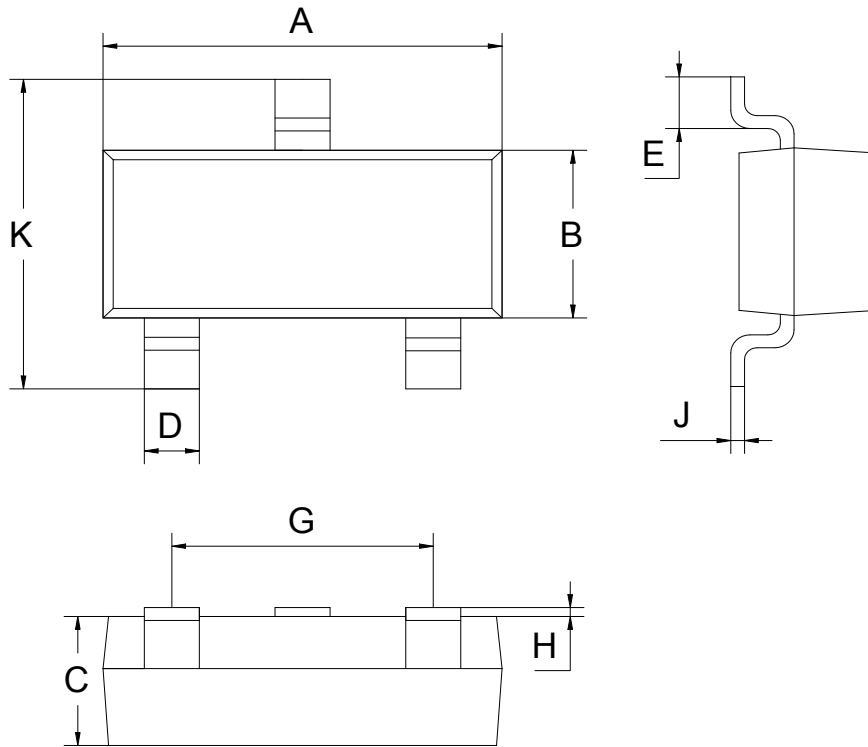

Figure 13. Drain-source breakdown voltage

SOT-23 Package Information



| SOT-23 | | | |
|----------------------|---------|------|------|
| Dim | MIN | NOM | MAX |
| A | 2.80 | 2.90 | 3.00 |
| B | 1.20 | 1.30 | 1.40 |
| C | 0.90 | 1.00 | 1.10 |
| D | 0.39 | 0.40 | 0.45 |
| E | 0.20MIN | | |
| G | 1.90REF | | |
| H | 0.00 | - | 0.10 |
| J | 0.05 | 0.10 | 0.15 |
| K | 2.30 | 2.40 | 2.50 |
| All Dimensions in mm | | | |