

## GTLP18T612 18-Bit LVTTTL/GTLP Universal Bus Transceiver

### General Description

The GTLP18T612 is an 18-bit universal bus transceiver which provides LVTTTL to GTLP signal level translation. It allows for transparent, latched and clocked modes of data transfer. The device provides a high speed interface for cards operating at LVTTTL logic levels and a backplane operating at GTLP logic levels. High speed backplane operation is a direct result of GTLP's reduced output swing (< 1V), reduced input threshold levels and output edge rate control. The edge rate control minimizes bus settling time. GTLP is a Fairchild Semiconductor derivative of the Gunning Transistor logic (GTL) JEDEC standard JESD8-3.

Fairchild's GTLP has internal edge-rate control and is Process, Voltage, and Temperature (PVT) compensated. Its function is similar to BTL or GTL but with different output levels and receiver thresholds. GTLP output LOW level is less than 0.5V, the output HIGH is 1.5V and the receiver threshold is 1.0V.

### Features

- Bidirectional interface between GTLP and LVTTTL logic levels
- Edge Rate Control to minimize noise on the GTLP port
- Power up/down high impedance for live insertion
- External  $V_{REF}$  pin for receiver threshold
- BiCMOS technology for low power dissipation
- Bushold data inputs on A Port eliminates the need for external pull-up resistors for unused inputs
- LVTTTL compatible Driver and Control inputs
- Flow-through architecture optimizes PCB layout
- Open drain on GTLP to support wired-or connection
- A-Port source/sink -24 mA/+24 mA
- B-Port sink capability +50 mA
- D-type flip-flop, latch and transparent data paths

### Ordering Code:

| Order Number  | Package Number | Package Description   |
|---------------|----------------|---|
| GTLP18T612MEA | MS56A          | 56-Lead Shrink Small Outline Package (SSOP), JEDEC MO-118, 0.300" Wide      |
| GTLP18T612MTD | MTD56          | 56-Lead Thin Shrink Small Outline Package (TSSOP), JEDEC MO-153, 6.1mm Wide |

Device also available in Tape and Reel. Specify by appending suffix letter "X" to the ordering code.

### Pin Descriptions

| Pin Names         | Description   |
|-------------------|---|
| $\overline{OEAB}$ | A-to-B Output Enable (Active LOW) (LVTTTL Level)      |
| $\overline{OEBA}$ | B-to-A Output Enable (Active LOW) (LVTTTL Level)      |
| $\overline{CEAB}$ | A-to-B Clock/LE Enable (Active LOW) (LVTTTL Level)    |
| $\overline{CEBA}$ | B-to-A Clock/LE Enable (Active LOW) (LVTTTL Level)    |
| LEAB              | A-to-B Latch Enable (Transparent HIGH) (LVTTTL Level) |
| LEBA              | B-to-A Latch Enable (Transparent HIGH) (LVTTTL Level) |
| $V_{REF}$         | GTL P Input Threshold Reference Voltage               |
| CLKAB             | A-to-B Clock (LVTTTL Level)                           |
| CLKBA             | B-to-A Clock (LVTTTL Level)                           |
| A1–A18            | A-to-B Data Inputs or B-to-A 3-STATE Outputs          |
| B1–B18            | B-to-A Data Inputs or A-to-B Open Drain Outputs       |

### Connection Diagram

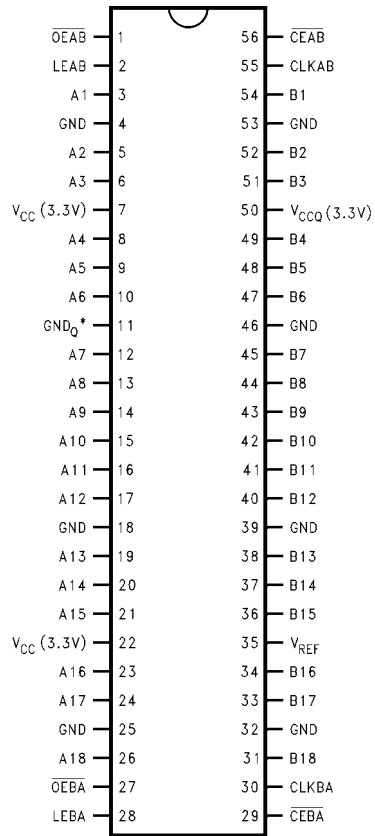

### Functional Description

The GTLP18T612 is an 18 bit registered transceiver containing D-type flip-flop, latch and transparent modes of operation for the data path. Data flow in each direction is controlled by the clock enables ( $\overline{CEAB}$  and  $\overline{CEBA}$ ), latch enables (LEAB and LEBA), clock (CLKAB and CLKBA) and output enables ( $\overline{OEAB}$  and  $\overline{OEBA}$ ). The clock enables ( $\overline{CEAB}$  and  $\overline{CEBA}$ ) and the output enables ( $\overline{OEAB}$  and  $\overline{OEBA}$ ) control the 18 bits of data for the A-to-B and B-to-A directions respectively.

For A-to-B data flow, when  $\overline{CEAB}$  is LOW, the device operates on the LOW-to-HIGH transition of CLKAB for the flip-flop and on the HIGH-to-LOW transition of LEAB for the latch path. That is, if  $\overline{CEAB}$  is LOW and LEAB is LOW the A data is latched regardless as to the state of CLKAB (HIGH or LOW) and if LEAB is HIGH the device is in transparent mode. When  $\overline{OEAB}$  is LOW the outputs are active. When  $\overline{OEAB}$  is HIGH the outputs are HIGH impedance. The data flow of B-to-A is similar except that  $\overline{CEBA}$ ,  $\overline{OEBA}$ , LEBA, and CLKBA are used.

### Truth Table (Note 1)

| Inputs            |                   |      |        |   | Output B       | Mode                      |
|-------------------|-------------------|------|--------|---|----------------|---------------------------|
| $\overline{CEAB}$ | $\overline{OEAB}$ | LEAB | CLKAB  | A |                |                           |
| X                 | H                 | X    | X      | X | Z              | Latched storage of A data |
| L                 | L                 | L    | H or L | X | $B_0$ (Note 2) |                           |
| L                 | L                 | L    | H or L | X | $B_0$ (Note 3) |                           |
| X                 | L                 | H    | X      | L | L              | Transparent               |
| X                 | L                 | H    | X      | H | H              |                           |
| L                 | L                 | L    | ↑      | L | L              | Clocked storage of A data |
| L                 | L                 | L    | ↑      | H | H              |                           |
| H                 | L                 | L    | X      | X | $B_0$ (Note 3) | Clock inhibit             |

**Note 1:** A-to-B data flow is shown. B-to-A data flow is similar but uses  $\overline{OEBA}$ , LEBA, CLKBA, and  $\overline{CEBA}$ .

**Note 2:** Output level before the indicated steady state input conditions were established, provided that CLKAB was HIGH before LEAB went LOW.

**Note 3:** Output level before the indicated steady-state input conditions were established.

### Logic Diagram

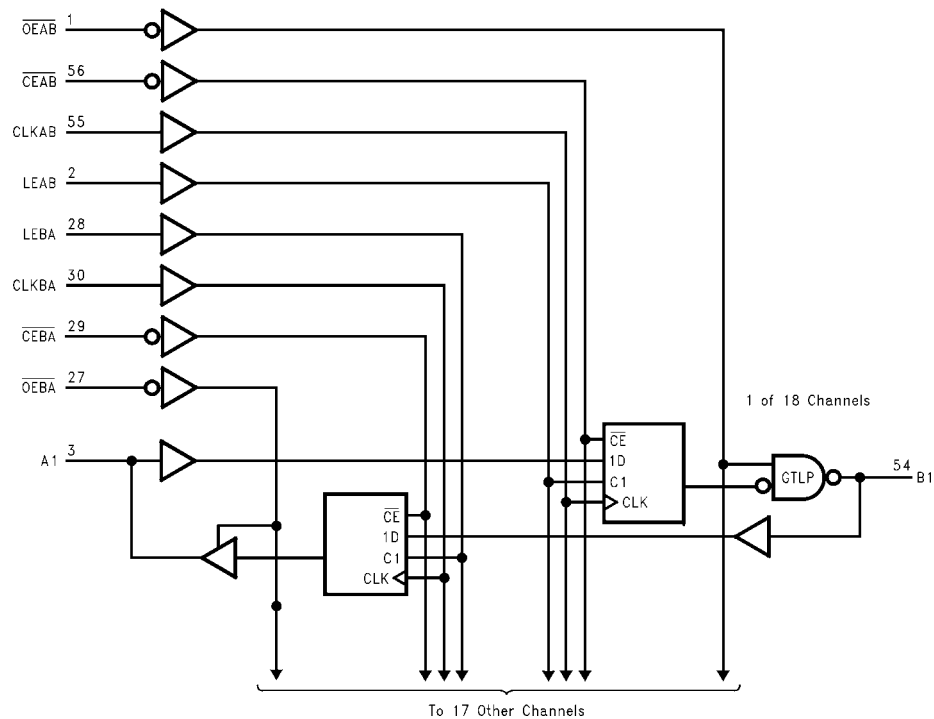

### Absolute Maximum Ratings (Note 4)

|                                      |                          |
|--------------------------------------|--------------------------|
| Supply Voltage ( $V_{CC}$ )          | -0.5V to +4.6V           |
| DC Input Voltage ( $V_I$ )           | -0.5V to +4.6V           |
| DC Output Voltage ( $V_O$ )          |                          |
| Outputs 3-STATE                      | -0.5V to +4.6V           |
| Outputs Active (Note 5)              | -0.5V to $V_{CC} + 0.5V$ |
| DC Output Sink Current into          |                          |
| A Port $I_{OL}$                      | 48 mA                    |
| DC Output Source Current from        |                          |
| A Port $I_{OH}$                      | -48 mA                   |
| DC Output Sink Current into          |                          |
| B Port in the LOW State, $I_{OL}$    | 100 mA                   |
| DC Input Diode Current ( $I_{IK}$ )  |                          |
| $V_I < 0V$                           | -50 mA                   |
| DC Output Diode Current ( $I_{OK}$ ) |                          |
| $V_O < 0V$                           | -50 mA                   |
| $V_O > V_{CC}$                       | +50 mA                   |
| ESD Performance                      | >2000V                   |
| Storage Temperature ( $T_{STG}$ )    | -65°C to +150°C          |

### Recommended Operating Conditions (Note 6)

|  |                |
|--|----------------|
| Supply Voltage $V_{CC}/V_{CCQ}$        | 3.15V to 3.45V |
| Bus Termination Voltage ( $V_{TT}$ )   |                |
| GTL P                                  | 1.47V to 1.53V |
| $V_{REF}$                              | 0.98V to 1.02V |
| Input Voltage ( $V_I$ )                |                |
| on A Port and Control Pins             | 0.0V to 3.45V  |
| on B Port                              | 0.0V to 3.45V  |
| HIGH Level Output Current ( $I_{OH}$ ) |                |
| A Port                                 | -24 mA         |
| LOW Level Output Current ( $I_{OL}$ )  |                |
| A Port                                 | +24 mA         |
| B Port                                 | +50 mA         |
| Operating Temperature ( $T_A$ )        | -40°C to +85°C |

**Note 4:** Absolute Maximum continuous ratings are those values beyond which damage to the device may occur. Exposure to these conditions or conditions beyond those indicated may adversely affect device reliability. Functional operation under absolute maximum rated conditions is not implied.

**Note 5:**  $I_O$  Absolute Maximum Rating must be observed.

**Note 6:** Unused inputs must be held HIGH or LOW.

### DC Electrical Characteristics

Over Recommended Operating Free-Air Temperature Range,  $V_{REF} = 1.0V$  (unless otherwise noted).

| Symbol               | Test Conditions         | Min  | Typ (Note 7)                 | Max              | Units   |
|----------------------|-------------------------|--|------------------------------|------------------|---------|
| $V_{IH}$             | B Port                  | $V_{REF} + 0.05$                               |                              | $V_{TT}$         | V       |
|                      | Others                  | 2.0  |                              |                  |         |
| $V_{IL}$             | B Port                  | 0.0  |                              | $V_{REF} - 0.05$ | V       |
|                      | Others                  |  |                              | 0.8              |         |
| $V_{REF}$            | GTL P (Note 8)          |  | 1.0                          |                  | V       |
|                      | GTL                     |  | 0.8                          |                  |         |
| $V_{IK}$             | $V_{CC} = 3.15V$        |  |                              | -1.2             | V       |
| $V_{OH}$             | A Port                  | $V_{CC}, V_{CCQ} = \text{Min to Max (Note 9)}$ | $I_{OH} = -100 \mu A$        | $V_{CC} - 0.2$   | V       |
|                      |                         | $V_{CC} = 3.15V$                               | $I_{OH} = -8 \text{ mA}$     | 2.4              |         |
|                      |                         |  | $I_{OH} = -24 \text{ mA}$    | 2.0              |         |
| $V_{OL}$             | A Port                  | $V_{CC}, V_{CCQ} = \text{Min to Max (Note 9)}$ | $I_{OL} = 100 \mu A$         | 0.2              | V       |
|                      |                         | $V_{CC} = 3.15V$                               | $I_{OL} = 24 \text{ mA}$     | 0.5              |         |
|                      | B Port                  | $V_{CC} = 3.15V$                               | $I_{OL} = 40 \text{ mA}$     | 0.40             | V       |
|                      |                         |  | $I_{OL} = 50 \text{ mA}$     | 0.55             |         |
| $I_I$                | Control Pins            | $V_{CC} = \text{Min to Max (Note 9)}$          | $V_I = 3.45V \text{ or } 0V$ | $\pm 5$          | $\mu A$ |
|                      | A Port                  | $V_{CC} = 3.45V$                               | $V_I = 0V$                   | -10              |         |
|                      |                         |  | $V_I = 3.45$                 | 10               |         |
| $I_{OFF}$            | A Port and Control Pins | $V_{CC} = 0$                                   | $V_I = V_{CC}$               | 5                | $\mu A$ |
|                      |                         |  | $V_I = 0$                    | -5               |         |
| $I_{I(\text{hold})}$ | A Port                  | $V_{CC} = 3.15V$                               | $V_I = 0.8V$                 | 75               | $\mu A$ |
|                      |                         |  | $V_I = 2.0V$                 | -75              |         |
| $I_{OZH}$            | A Port                  | $V_{CC} = 3.45V$                               | $V_O = 3.45$                 | 10               | $\mu A$ |
|                      | B Port                  |  | $V_O = 1.5V$                 | 5                |         |
| $I_{OZL}$            | A Port                  | $V_{CC} = 3.45V$                               | $V_O = 0V$                   | -10              | $\mu A$ |
|                      | B Port                  |  | $V_O = 0.55V$                | -5               |         |

## DC Electrical Characteristics (Continued)

| Symbol                           | Test Conditions   | Min              | Typ (Note 7) | Max | Units |
|----------------------------------|---|------------------|--------------|-----|-------|
| $I_{CC}$<br>( $V_{CC}/V_{CCQ}$ ) | A or B Ports<br>$V_{CC} = 3.45V$<br>$I_O = 0$<br>$V_I = V_{CC}$ or GND                  | Outputs HIGH     | 30           | 40  | mA    |
|                                  |   | Outputs LOW      | 30           | 40  |       |
|                                  |   | Outputs Disabled | 30           | 45  |       |
| $\Delta I_{CC}$<br>(Note 10)     | A Port and Control Pins<br>$V_{CC} = 3.45V$ ,<br>A or Control Inputs at $V_{CC}$ or GND |                  | 0            | 2   | mA    |
| $C_i$                            | Control Pins  |                  | 6            |     | pF    |
|                                  | A Port  |                  | 7.5          |     |       |
|                                  | B Port  |                  | 9.0          |     |       |

**Note 7:** All typical values are at  $V_{CC} = 3.3V$ ,  $V_{CCQ} = 3.3V$ , and  $T_A = 25^\circ C$ .

**Note 8:** GTLP  $V_{REF}$  and  $V_{TT}$  are specified to 2% tolerance since signal integrity and noise margin can be significantly degraded if these supplies are noisy. In addition,  $V_{TT}$  and Rterm can be adjusted beyond the recommended operating conditions to accommodate backplane impedances other than 50Ω, but must remain within the boundaries of the DC Absolute Maximum ratings. Similarly  $V_{REF}$  can be adjusted to optimize noise margin.

**Note 9:** For conditions shown as Min or Max, use the appropriate value specified under recommended operating conditions.

**Note 10:** This is the increase in supply current for each input that is at the specified TTL voltage level rather than  $V_{CC}$  or GND.

## AC Operating Requirements

Over recommended ranges of supply voltage and operating free-air temperature,  $V_{REF} = 1.0V$  (unless otherwise noted).

| Symbol      | Test Conditions         | Min                             | Max | Unit |
|-------------|-------------------------|---------------------------------|-----|------|
| $f_{CLOCK}$ | Maximum Clock Frequency | 0                               | 175 | MHz  |
| $t_{WIDTH}$ | Pulse Duration          | LEAB or LEBA HIGH               | 3.0 | ns   |
|             |                         | CLKAB or CLKBA HIGH or LOW      | 3.0 |      |
| $t_{SU}$    | Setup Time              | A before CLKAB↑                 | 1.1 | ns   |
|             |                         | B before CLKBA↑                 | 3.0 |      |
|             |                         | A before LEAB                   | 1.1 |      |
|             |                         | B before LEBA                   | 2.7 |      |
|             |                         | $\overline{CEAB}$ before CLKAB↑ | 1.2 |      |
|             |                         | $\overline{CEBA}$ before CLKBA↑ | 1.4 |      |
| $t_{HOLD}$  | Hold Time               | A after CLKAB↑                  | 0.0 | ns   |
|             |                         | B after CLKBA↑                  | 0.0 |      |
|             |                         | A after LEAB                    | 0.8 |      |
|             |                         | B after LEBA                    | 0.0 |      |
|             |                         | $\overline{CEAB}$ after CLKAB↑  | 1.0 |      |
|             |                         | $\overline{CEBA}$ after CLKBA↑  | 1.9 |      |

### AC Electrical Characteristics

Over recommended range of supply voltage and operating free-air temperature,  $V_{REF} = 1.0V$  (unless otherwise noted).  
 $C_L = 30\text{ pF}$  for B Port and  $C_L = 50\text{ pF}$  for A Port.

| Symbol                                   | From (Input)                            | To (Output) | Min        | Typ (Note 11) | Max        | Unit |
|--|---|-------------|------------|---------------|------------|------|
| $t_{PLH}$<br>$t_{PHL}$                   | A                                       | B           | 2.1<br>1.0 | 4.1<br>2.7    | 6.3<br>4.4 | ns   |
| $t_{PLH}$<br>$t_{PHL}$                   | LEAB                                    | B           | 2.2<br>1.0 | 4.2<br>2.4    | 6.3<br>4.2 | ns   |
| $t_{PLH}$<br>$t_{PHL}$                   | CLKAB                                   | B           | 2.2<br>1.0 | 4.4<br>2.5    | 6.5<br>4.4 | ns   |
| $t_{PLH}$<br>$t_{PHL}$                   | $\overline{OEAB}$                       | B           | 2.0<br>1.0 | 3.8<br>2.6    | 5.6<br>4.3 | ns   |
| $t_{RISE}$                               | Transition time, B outputs (20% to 80%) |             |            | 3.1           |            | ns   |
| $t_{FALL}$                               | Transition time, B outputs (20% to 80%) |             |            | 2.1           |            |      |
| $t_{PLH}$<br>$t_{PHL}$                   | B                                       | A           | 1.8<br>1.8 | 3.8<br>3.8    | 5.8<br>5.8 | ns   |
| $t_{PLH}$<br>$t_{PHL}$                   | LEBA                                    | A           | 0.3<br>0.4 | 2.2<br>2.4    | 4.6<br>4.6 | ns   |
| $t_{PLH}$<br>$t_{PHL}$                   | CLKBA                                   | A           | 0.5<br>0.6 | 2.4<br>2.6    | 4.6<br>4.6 | ns   |
| $t_{PZH}, t_{PZL}$<br>$t_{PHZ}, t_{PLZ}$ | $\overline{OEBA}$                       | A           | 0.3<br>0.3 | 2.7<br>2.5    | 5.2<br>5.2 | ns   |

**Note 11:** All typical values are at  $V_{CC} = 3.3V$ , and  $T_A = 25^\circ C$ .

### Extended Electrical Characteristics

Over recommended ranges of supply voltage and operating free-air temperature  $V_{REF} = 1.0V$  (unless otherwise noted).  
 $C_L = 30\text{ pF}$  for B Port and  $C_L = 50\text{ pF}$  for A Port.

| Symbol                          | From (Input) | To (Output) | Min | Typ (Note 11) | Max | Unit |
|---------------------------------|--------------|-------------|-----|---------------|-----|------|
| $t_{OSLH}$ (Note 12)            | A            | B           |     | 0.8           | 1.0 | ns   |
| $t_{OSHL}$ (Note 12)            | A            | B           |     | 0.3           | 0.5 | ns   |
| $t_{PV(HL)}$ (Note 13)(Note 14) | A            | B           |     |               | 0.8 | ns   |
| $t_{OSLH}$ (Note 12)            | CLKAB        | B           |     | 0.9           | 1.0 | ns   |
| $t_{OSHL}$ (Note 12)            | CLKAB        | B           |     | 0.3           | 0.5 | ns   |
| $t_{PV(HL)}$ (Note 13)(Note 14) | CLKAB        | B           |     |               | 0.8 | ns   |
| $t_{OSLH}$ (Note 12)            | B            | A           |     | 0.7           | 1.0 | ns   |
| $t_{OSHL}$ (Note 12)            | B            | A           |     | 0.6           | 1.0 | ns   |
| $t_{OST}$ (Note 12)             | B            | A           |     | 0.7           | 1.1 | ns   |
| $t_{PV}$ (Note 13)              | B            | A           |     |               | 1.5 | ns   |
| $t_{OSLH}$ (Note 12)            | CLKAB        | A           |     | 0.5           | 1.0 | ns   |
| $t_{OSHL}$ (Note 12)            | CLKAB        | A           |     | 0.6           | 1.0 | ns   |
| $t_{OST}$ (Note 12)             | CLKAB        | A           |     | 1.1           | 1.2 | ns   |
| $t_{PV}$ (Note 13)              | CLKAB        | A           |     |               | 1.5 | ns   |

**Note 12:**  $t_{OSHL}/t_{OSLH}$  and  $t_{OST}$  - Output to output skew is defined as the absolute value of the difference between the actual propagation delay for all outputs within the same packaged device. The specifications are given for specific worst case  $V_{CC}$  and temperature and apply to any outputs switching in the same direction either HIGH-to-LOW ( $t_{OSHL}$ ) or LOW-to-HIGH ( $t_{OSLH}$ ) or in opposite directions both HL and LH ( $t_{OST}$ ). This parameter is guaranteed by design and statistical process distribution. Actual skew values between the GTLP outputs could vary on the backplane due to the loading and impedance seen by the device.

**Note 13:**  $t_{PV}$  - Part to part skew is defined as the absolute value of the difference between the actual propagation delay for all outputs from device to device. The parameter is specified for a specific worst case  $V_{CC}$  and temperature. This parameter is guaranteed by design and statistical process distribution. Actual skew values between the GTLP outputs could vary on the backplane due to the loading and impedance seen by the device.

**Note 14:** Due to the open drain structure on GTLP outputs  $t_{OST}$  and  $t_{PV(LH)}$  in the A-to-B direction are not specified. Skew on these paths is dependent on the  $V_{TT}$  and  $R_T$  values on the backplane.

## Test Circuits and Timing Waveforms

**Test Circuit for A Outputs**

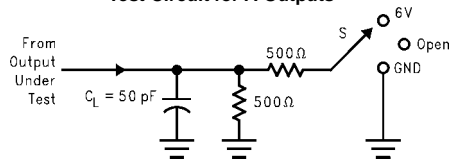

| Test              | S    |
|-------------------|------|
| $t_{PLH}/t_{PHL}$ | Open |
| $t_{PLZ}/t_{PZL}$ | 6V   |
| $t_{PHZ}/t_{PZH}$ | GND  |

**Note A:**  $C_L$  includes probes and Jig capacitance.

**Test Circuit for B Outputs**

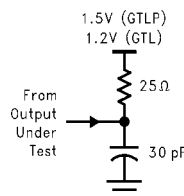

**Note B:** For B Port,  $C_L = 30$  pF is used for worst case.

**Voltage Waveform - Propagation Delay Times**

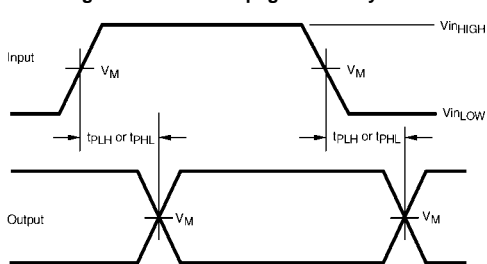

**Voltage Waveform - Setup and Hold Times**

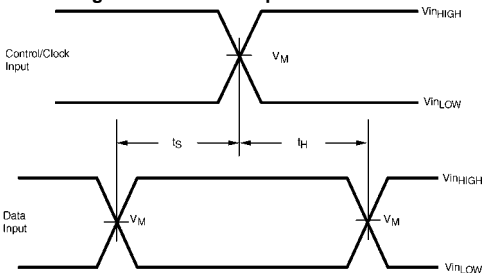

**Voltage Waveform - Pulse Width**

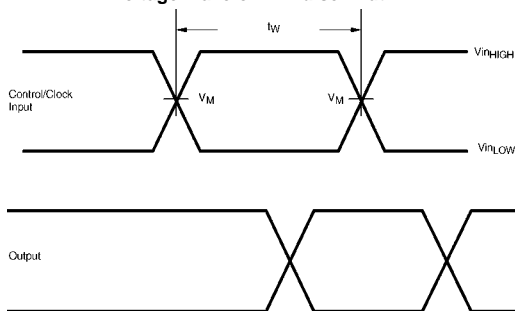

**Voltage Waveform - Enable and Disable times**

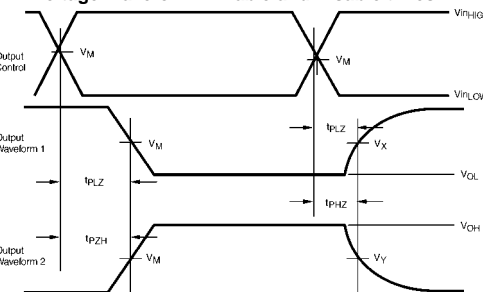

Output Waveform 1 is for an output with internal conditions such that the output is LOW except when disabled by the control output.  
Output Waveform 2 is for an output with internal conditions such that the output is HIGH except when disabled by the control output.

**Input and Measure Conditions**

|              | A or LVTTTL Pins | B or GTLP Pins |
|--------------|------------------|----------------|
| $V_{inHIGH}$ | 3.0              | 1.5            |
| $V_{inLOW}$  | 0.0              | 0.0            |
| $V_M$        | 1.5              | 1.0            |
| $V_X$        | $V_{OL} + 0.3V$  | N/A            |
| $V_Y$        | $V_{OH} - 0.3V$  | N/A            |

All input pulses have the following characteristics: Frequency = 10MHz,  $t_{RISE} = t_{FALL} = 2$  ns (10% to 90%),  $Z_0 = 50\Omega$ . The outputs are measured one at a time with one transition per measurement.

**Physical Dimensions** inches (millimeters) unless otherwise noted

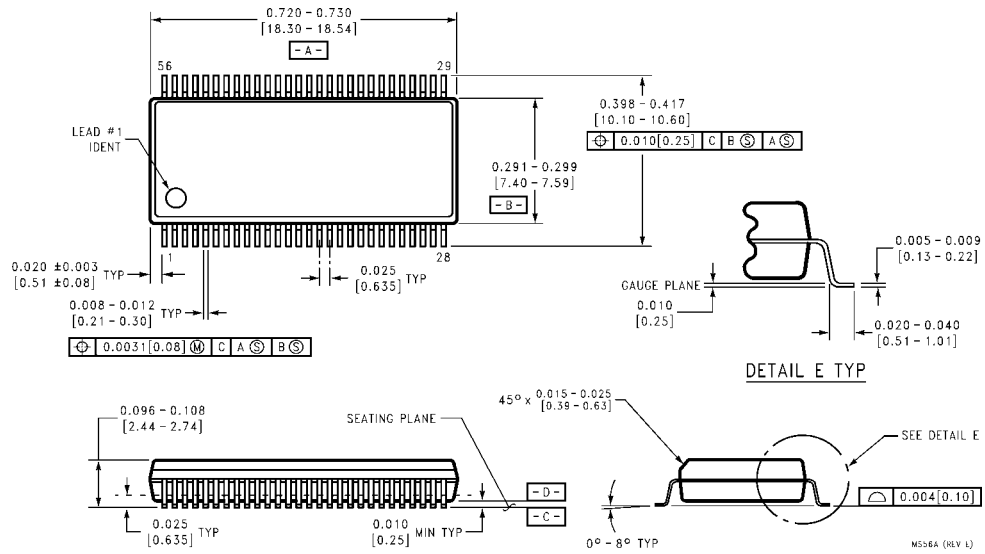

**56-Lead Shrink Small Outline Package (SSOP), JEDEC MO-118, 0.300" Wide  
Package Number MS56A**



**Physical Dimensions** inches (millimeters) unless otherwise noted (Continued)

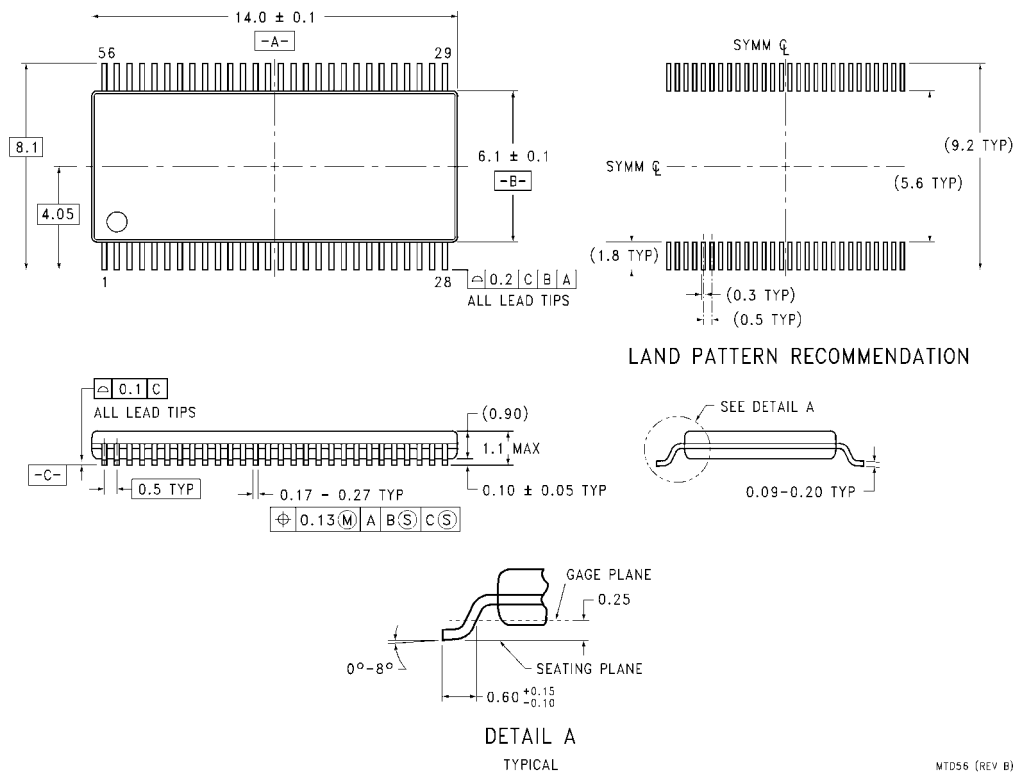

**56-Lead Thin Shrink Small Outline Package (TSSOP), JEDEC MO-153, 6.1mm Wide  
Package Number MTD56**

MTD56 (REV B)

Fairchild does not assume any responsibility for use of any circuitry described, no circuit patent licenses are implied and Fairchild reserves the right at any time without notice to change said circuitry and specifications.

**LIFE SUPPORT POLICY**

FAIRCHILD'S PRODUCTS ARE NOT AUTHORIZED FOR USE AS CRITICAL COMPONENTS IN LIFE SUPPORT DEVICES OR SYSTEMS WITHOUT THE EXPRESS WRITTEN APPROVAL OF THE PRESIDENT OF FAIRCHILD SEMICONDUCTOR CORPORATION. As used herein:

1. Life support devices or systems are devices or systems which, (a) are intended for surgical implant into the body, or (b) support or sustain life, and (c) whose failure to perform when properly used in accordance with instructions for use provided in the labeling, can be reasonably expected to result in a significant injury to the user.
2. A critical component in any component of a life support device or system whose failure to perform can be reasonably expected to cause the failure of the life support device or system, or to affect its safety or effectiveness.

[www.fairchildsemi.com](http://www.fairchildsemi.com)