



June 1998
Revised October 1998

GTL6C816 GTLP-to-TTL 1:6 Clock Driver

GTL6C816 GTLP-to-TTL 1:6 Clock Driver

General Description

The GTLP6C816 is a clock driver that provides TTL to GTLP signal level translation (and vice versa). The device provides a high speed interface between cards operating at TTL logic levels and a backplane operating at GTLP logic levels. High speed backplane operation is a direct result of GTLP's reduced output swing (<1V), reduced input threshold levels and output edge rate control. The edge rate control minimizes bus settling time. GTLP is a Fairchild Semiconductor derivative of the Gunning Transceiver logic (GTL) JEDEC standard JESD8-3.

Fairchild's GTLP has internal edge-rate control and is process, voltage, and temperature (PVT) compensated. Its function is similar to BTL and GTL but with different output levels and receiver threshold. GTLP output LOW level is

typically less than 0.5V, the output level HIGH is 1.5V and the receiver threshold is 1.0V.

Features

- Interface between TTL and GTLP logic levels
- Edge Rate Control to minimize noise on the GTLP port
- Power up/down high impedance for live insertion
- 1:6 fanout clock driver for TTL port
- 1:2 fanout clock driver for GTLP port
- TTL compatible driver and control inputs
- Flow through pinout optimizes PCB layout
- Open drain on GTLP to support wired-or connection
- Recommended Operating Temperature -40°C to +85°C

Ordering Code:

Order Number	Package Number	Package Description
GTL6C816MTC	MTC24	24-Lead Thin Shrink Small Outline Package (TSSOP), JEDEC MO-153, 4.4mm Wide

Pin Descriptions

Pin Names	Description
TTLIN, GTLPIN	Clock Inputs (TTL and GTLP respectively)
\overline{OEB}	Output Enable (Active LOW) GTLP Port (TTL Levels)
\overline{OEA}	Output Enable (Active LOW) TTL Port (TTL Levels)
V _{CCT} -GNDT	TTL Output Supplies (5V)
V _{CC}	Internal Circuitry V _{CC} (5V)
GNDG	OBn GTLP Output Grounds
V _{REF}	Voltage Reference Input
OA0-OA5	TTL Buffered Clock Outputs
OB0-OB1	GTLP Buffered Clock Outputs

Connection Diagram

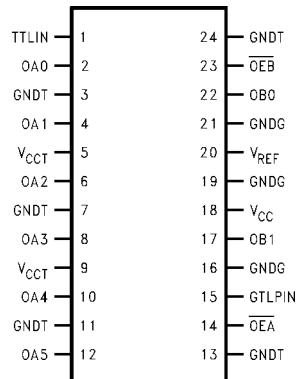

Functional Description

The GTLP6C816 is a clock driver providing TTL-to-GTLP clock translation, and GTLP-to-TTL clock translation in the same package. The TTL-to-GTLP direction is a 1:2 clock driver path with a single Enable pin (\overline{OEB}). For the GTLP-to-TTL direction the clock receiver path is a 1:6 buffer with a single Enable control (\overline{OEA}). Data polarity is inverting for both directions.

Truth Tables

Inputs		Outputs
TTLIN	\overline{OEB}	O _{Bn}
H	L	L
L	L	H
X	H	High Z

Inputs		Outputs
GTLPIN	\overline{OEA}	O _{An}
H	L	L
L	L	H
X	H	High Z

Logic Diagram

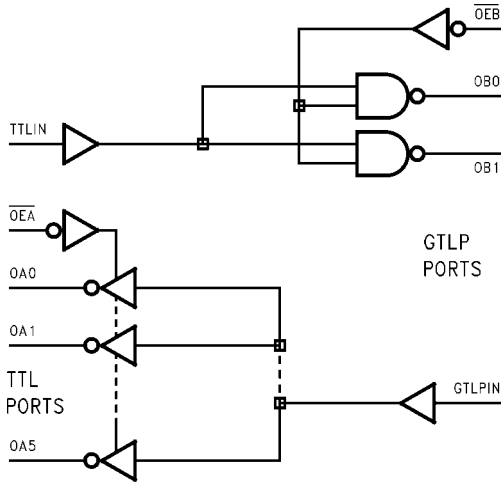

Absolute Maximum Ratings (Note 1)

Supply Voltage (V_{CC})	-0.5V to +7.0V
DC Input Voltage (V_I)	-0.5V to +7.0V
DC Output Voltage (V_O)	
Outputs 3-STATE	-0.5V to +7.0V
Outputs Active (Note 2)	-0.5V to +7.0V
DC Output Sink Current into OA-Port I_{OL}	48 mA
DC Output Source Current from OA-Port I_{OH}	-48 mA
DC Output Sink Current into OB-Port in the LOW State I_{OL}	80 mA
DC Input Diode Current (I_{IK})	
$V_I < 0V$	-50 mA
DC Output Diode Current (I_{OK})	
$V_O < 0V$	-50 mA
$V_O > V_{CC}$	+50 mA
ESD Rating	> 2000V
Storage Temperature (T_{STG})	-65°C to +150°C

Recommended Operating Conditions (Note 3)

Supply Voltage V_{CC}	4.75V to 5.25V
Bus Termination Voltage (V_{TT})	
GTLP	1.47V to 1.53V
V_{REF}	0.98V to 1.02V
Input Voltage (V_I) on INA-Port and Control Pins	0.0V to 5.5V
HIGH Level Output Current (I_{OH})	
OA-Port	-24 mA
LOW Level Output Current (I_{OL})	
OA-Port	+24 mA
OB-Port	+34 mA
Operating Temperature (T_A)	-40°C to +85°C

Note 1: Absolute Maximum continuous ratings are those values beyond which damage to the device may occur. Exposure to these conditions or conditions beyond those indicated may adversely affect device reliability. Functional operation under absolute maximum rated conditions is not implied.

Note 2: I_O Absolute Maximum Rating must be observed.

Note 3: Unused input must be held high or low.

DC Electrical Characteristics

Over Recommended Operating Free-Air Temperature Range, $V_{REF} = 1.0V$ (unless otherwise noted).

Symbol		Test Conditions		Min	Typ (Note 4)	Max	Units
V_{IH}	GTLPIN			$V_{REF} + 0.05$		V_{TT}	V
	Others			2.0			
V_{IL}	GTLPIN			0.0		$V_{REF} - 0.05$	V
	Others					0.8	
V_{REF} (Note 5)	GTLP				1.0		V
	GTL				0.8		
V_{TT} (Note 5)	GTLP				1.5		V
	GTL				1.2		
V_{IK}		$V_{CC} = 4.75V$	$I_I = -18\text{ mA}$			-1.2	V
V_{OH}	OAn-Port	$V_{CC} = 4.75V$	$I_{OH} = -100\ \mu A$	$V_{CC} - 0.2$			V
			$I_{OH} = -18\text{ mA}$	2.4			
			$I_{OH} = -24\text{ mA}$	2.2			
V_{OL}	OAn-Port	$V_{CC} = 4.75V$	$I_{OL} = 100\ \mu A$			0.2	V
			$I_{OL} = 18\text{ mA}$			0.4	
			$I_{OL} = 24\text{ mA}$			0.5	
V_{OL}	OBn-Port	$V_{CC} = 4.75V$	$I_{OL} = 100\ \mu A$			0.2	V
			$I_{OL} = 34\text{ mA}$			0.65	
I_I	TTLIN/ Control Pins	$V_{CC} = 5.25V$	$V_I = 5.25V$ $V_I = 0V$			5 -5	μA
	GTLPIN	$V_{CC} = 5.25V$	$V_I = V_{TT}$ $V_I = 0$			5 -5	μA
I_{OFF}	TTLIN	$V_{CC} = 0$	V_I or $V_O = 0V$ to 5.25V			100	μA
I_{OZH}	OAn-Port	$V_{CC} = 5.25V$	$V_O = 5.25V$			5	μA
	OBn-Port		$V_O = 1.5V$			5	
I_{OZL}	OAn-Port	$V_{CC} = 5.25V$	$V_O = 0$			-5	μA
I_{CC}	OAn or OBn Ports	$V_{CC} = 5.25V$	Outputs HIGH		7	18	mA
			Outputs LOW		7	20	
			$V_I = V_{CC}$ or GND	Outputs Disabled		7	
ΔI_{CC}	TTLIN	$V_{CC} = 5.25V$	$V_I = V_{CC} - 2.1$			6	mA
C_{IN}	Control Pins/GTLPIN/ TTLIN		$V_I = V_{CC}$ or 0		3.7		pF
C_{OUT}	OAn-Port		$V_I = V_{CC}$ or 0		7		pF
	OBn-Port		$V_I = V_{CC}$ or 0		7		

Note 4: All typical values are at $V_{CC} = 5.0V$ and $T_A = 25^\circ C$.

Note 5: GTLP V_{REF} and V_{TT} are specified to 2% tolerance since signal integrity and noise margin can be significantly degraded if these supplies are noisy. In addition, V_{TT} and R_{TERM} can be adjusted to accommodate backplane impedances other than 50Ω , within the boundaries of not exceeding the DC Absolute I_{OL} ratings. Similarly V_{REF} can be adjusted to compensate for changes in V_{TT} .

AC Electrical Characteristics

Over recommended range of supply voltage and operating free air temperature. $V_{REF} = 1.0V$ (unless otherwise noted).
 $C_L = 30\text{ pF}$ for OBn-Port and $C_L = 50\text{ pF}$ for OAn-Port.

Symbol	From (Input)	To (Output)	Min	Typ (Note 6)	Max	Units
t_{PLH} t_{PHL}	TTLIN	OBn	1.5 1.5	3.8 2.8	6.0 5.0	ns
t_{PLH} t_{PHL}	\overline{OEB}	OBn	1.5 1.5	6.4 3.2	10.5 6.0	ns
t_{RISE}	Transition Time, OB Outputs (20% to 80%)			2.3		ns
t_{FALL}	Transition Time, OB outputs (20% to 80%)			2.3		ns
t_{RISE}	Transition Time, OA outputs (10% to 90%)			2.0		ns
t_{FALL}	Transition Time, OA outputs (10% to 90%)			2.0		ns
t_{PZH} , t_{PZL} t_{PLZ} , t_{PHZ}	\overline{OEA}	OAn	0.5 0.5	3.6 3.8	6.5 6.5	ns
t_{PLH} t_{PHL}	GTLPIN	OAn	1.5 1.5	4.4 4.0	6.5 6.0	ns
t_{OSHL} , t_{OSLH} (Note 7)	Common Edge Skew			0.2	1.0	ns

Note 6: All typical values are at $V_{CC} = 5.0V$ and $T_A = 25^\circ C$.

Note 7: Skew specs are given for specific worst case V_{CC} Temp. Skew values between the OBn outputs could vary on the backplane due to loading and impedance seen by the device.

Test Circuit and Timing Waveforms

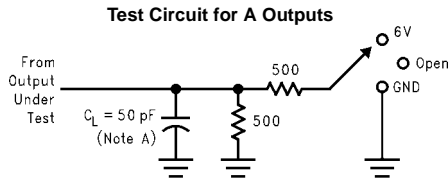

Test S
 t_{PLH}/t_{PHL} Open
 t_{PLZ}/t_{PZL} 6V
 t_{PHZ}/t_{PZH} GND

Note A: C_L includes probes and jig capacitance.

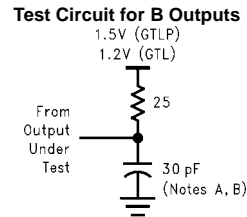

Note A: C_L includes probes and jig capacitance.
 Note B: For B-Port $C_L = 30$ pF is used for worst case.

Voltage Waveforms Enable and Disable Times A-Port

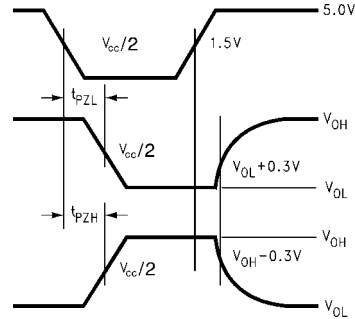

Voltage Waveforms Propagation Delay ($V_m = V_{CC}/2$ for A-Port and 1.0 for B-Port)

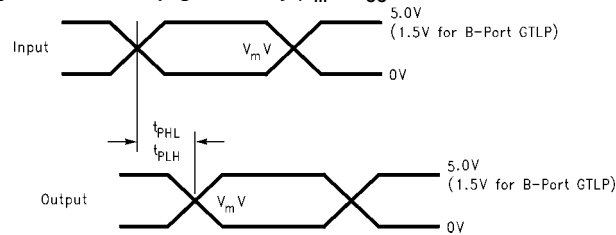

Physical Dimensions inches (millimeters) unless otherwise noted

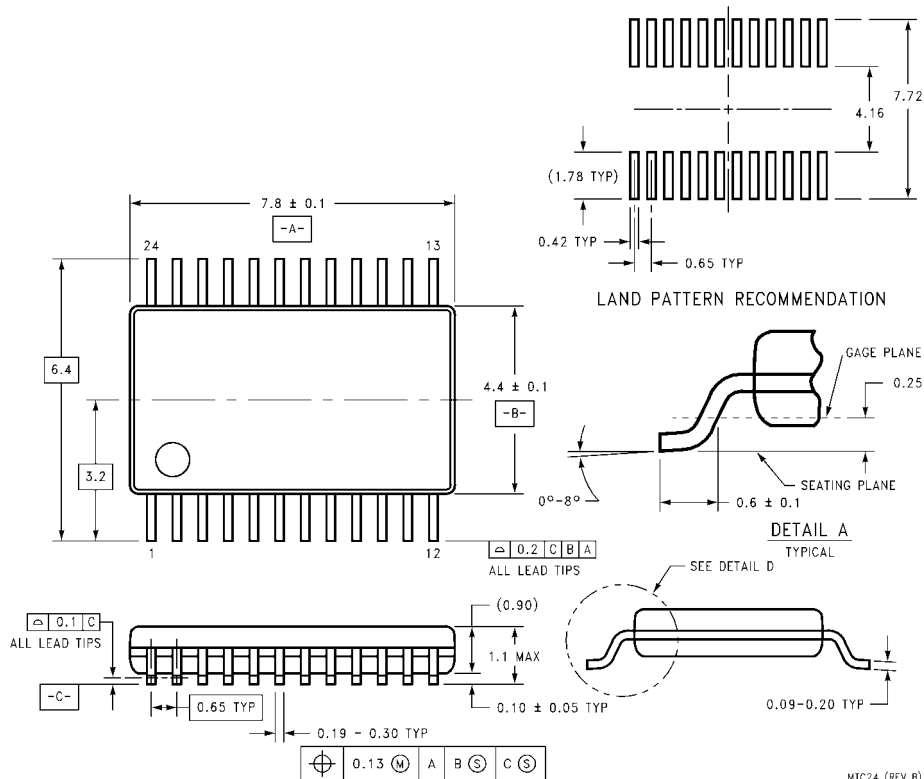

24-Lead Thin Shrink Small Outline Package (TSSOP), JEDEC MO-153, 4.4mm Wide
Package Number MTC24

MTC24 (REV B)

LIFE SUPPORT POLICY

FAIRCHILD'S PRODUCTS ARE NOT AUTHORIZED FOR USE AS CRITICAL COMPONENTS IN LIFE SUPPORT DEVICES OR SYSTEMS WITHOUT THE EXPRESS WRITTEN APPROVAL OF THE PRESIDENT OF FAIRCHILD SEMICONDUCTOR CORPORATION. As used herein:

1. Life support devices or systems are devices or systems which, (a) are intended for surgical implant into the body, or (b) support or sustain life, and (c) whose failure to perform when properly used in accordance with instructions for use provided in the labeling, can be reasonably expected to result in a significant injury to the user.
2. A critical component in any component of a life support device or system whose failure to perform can be reasonably expected to cause the failure of the life support device or system, or to affect its safety or effectiveness.

www.fairchildsemi.com