



SPECIFICATIONS

LCD Module User Manual

Module No.: GTV350MPZI-04
REV. A



Dalian Good Display Co., Ltd

Tel.: 86-411-84619565 / 84573876

Fax: 86-411-84619585

E-mail: sales@good-lcd.com.cn

Website: <http://www.good-lcd.com>



DOCUMENT REVISION HISTORY

DOCUMENT REVISION FROM TO	DATE	DESCRIPTION	CHANGED BY	CHECKED BY
A	2009.09.16	First Release.	BETTY MAO	RICHE ZHANG

CONTENTS

	<u>Page No.</u>
1. GENERAL DESCRIPTION	4
2. MECHANICAL SPECIFICATIONS	4
3. INTERFACE SIGNALS	7
4. ABSOLUTE MAXIMUM RATINGS	8
4.1 ELECTRICAL MAXIMUM RATINGS - FOR IC ONLY	8
4.2 DC CHARACTERISTICS	8
4.3 ENVIRONMENTAL CONDITION	9
5. ELECTRICAL SPECIFICATIONS	10
5.1 TYPICAL ELECTRICAL CHARACTERISTICS	10
5.2 TIMING SPECIFICATIONS	11
6. OPTICAL CHARACTERISTICS(FOR TFT PANEL ONLY)	12
6.1 DEFINITIONS AND MEASURING METHODS	13
7. TFT PANEL INSPECTION SPECIFICATIONS	15



GOOD DISPLAY

Preliminary Specification of LCD Module Type Model No.: GTV350MPZI-04

1. General Description

- 3.5”(diagonal), 320xRGBx480 dots, 262k colors, Transmissive, TFT LCD module.
- Viewing angle: 12 o'clock.
- Driving IC: 'ILITEK' ILI9481 TFT controller driver or equivalent.
- 80 system 16-bit parallel bus interface.
- Logic voltage: 1.8V&2.8V.
- White LED05 backlight.
- FPC connection.
- "RoHS" compliance.

2. Mechanical Specifications

The mechanical detail is shown in Fig. 1 and summarized in Table 1 below.

Table 1

Parameter		Specifications	Unit
Outline dimensions		58.04(W) x 87.60(H) x 2.35(D)	mm
Color TFT 176xRGBx220	Active area	49.44(W) x 74.164(H)	mm
	Display format	320 x RGB x 480	dots
	Color configuration	RGB stripes	-
	Dot size	0.154(W) x 0.154(H)	mm
Weight		TBD	gram

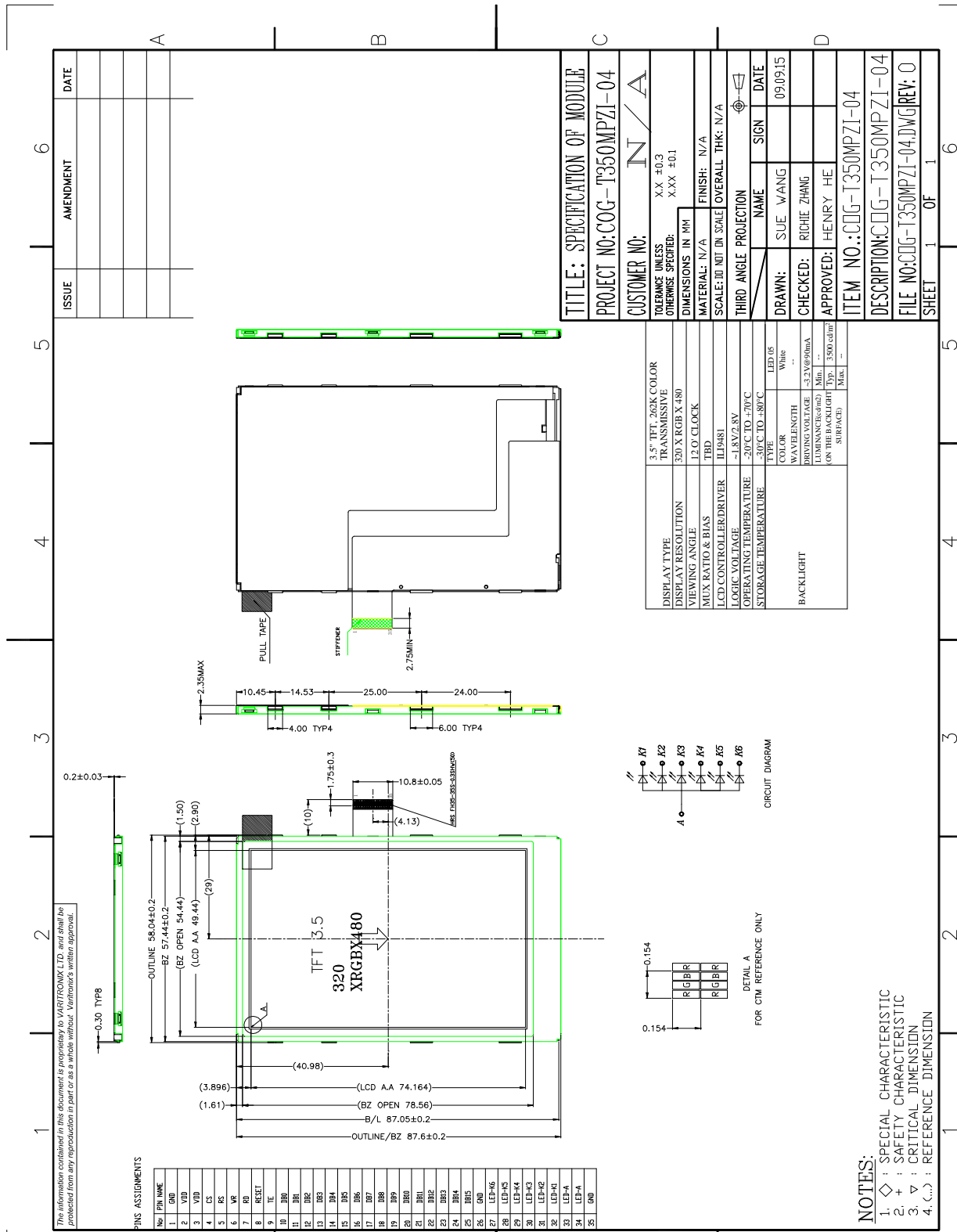

ISSUE	AMENDMENT	DATE

TITLE: SPECIFICATION OF MODULE
PROJECT NO: COG-T350MPZI-04
CUSTOMER NO: N/A
 TOLERANCE UNLESS OTHERWISE SPECIFIED: XX ±0.3
 XXX ±0.1
 DIMENSIONS IN MM
 MATERIAL: N/A
 FINISH: N/A
 SCALE: 30 NOT IN SCALE
 OVERALL THK: N/A
THIRD ANGLE PROJECTION

NAME	SIGN	DATE
DRAWN: SUE WANG		09/09/15
CHECKED: RICHIE ZHANG		
APPROVED: HENRY HE		

ITEM NO: COG-T350MPZI-04
DESCRIPTION: COG-T350MPZI-04
FILE NO: COG-T350MPZI-04.DWG
REV: 0
 SHEET 1 OF 1

Figure 1: Module Specification

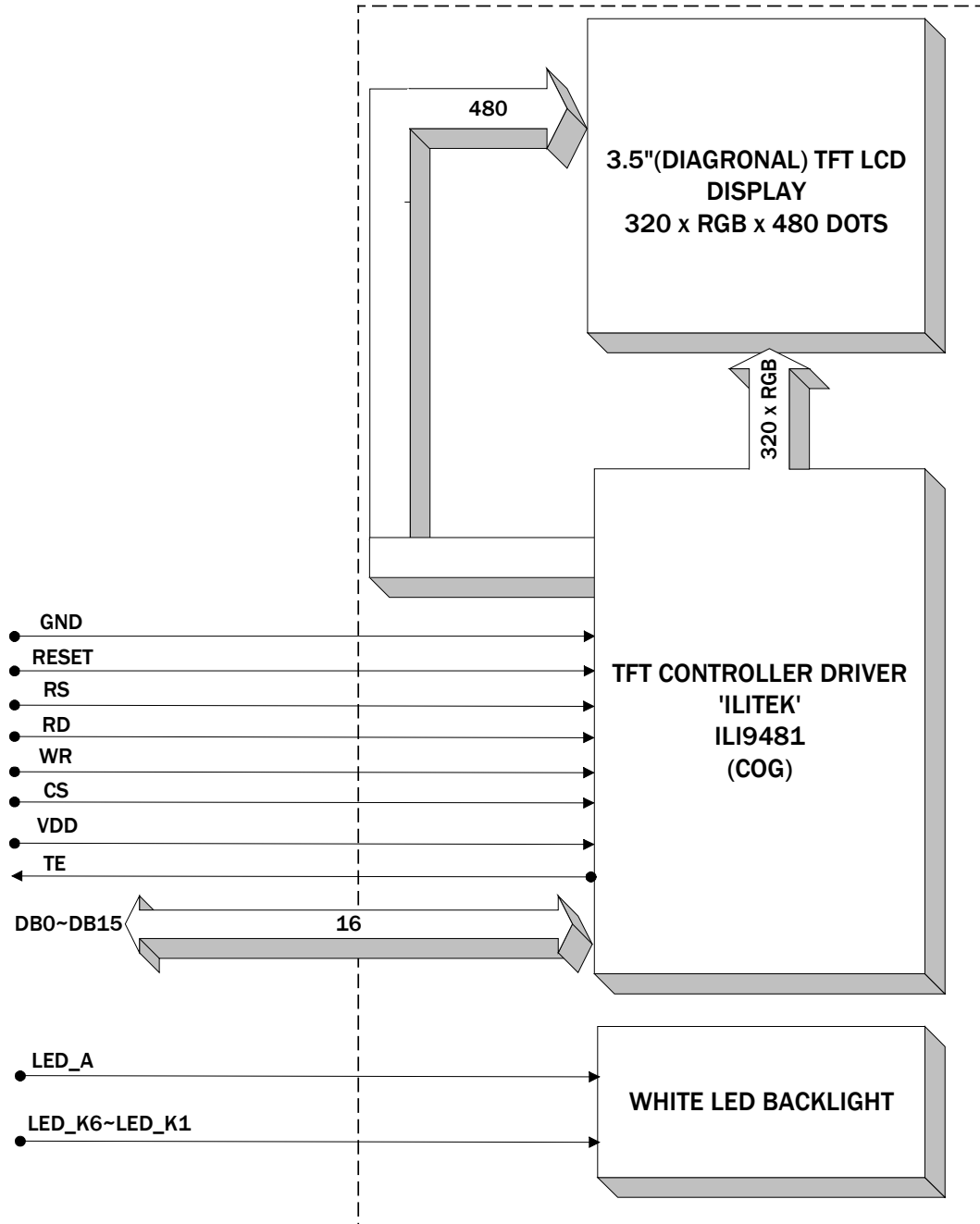

Figure 2: Block Diagram



3. Interface signals

Table 2: Pin assignment

Pin No.	Symbol	Description
1	GND	Ground.
2,3	VDD	Power supply.
4	CS(CSX)	Chip select input pin ("Low" enable).
5	RS(D/CX)	Display data / Command selection pin. D/CX='1': Display data. D/CX='0': Command data.
6	WR(WRX)	Write control pin for the DBI interface. When the DBI type C is selected, this pin is used as serial clock pin.
7	RD(RDX)	Read control pin for the DBI interface.
8	RESET (RESX)	This signal low will reset the device and must be applied to properly initialize the chip. Signal is low active.
9	TE	Tearing effect output pin to synchronies MCU to frame writing, activated by S/W command. When this pin is not activated, this pin is low.
10~25	DB0~DB15	Data bus.
26	GND	Ground.
27~32	LEDK6~K1	Cathode of LED backlight.
33,34	LEDA	Anode of LED backlight.
35	GND	Ground.



4. Absolute Maximum Ratings

4.1 Electrical Maximum Ratings – for IC Only

The absolute maximum rating is listed on following table. When ILI9481 is used out of the absolute maximum ratings, the ILI9481 may be permanently damaged. To use the ILI9481 within the following electrical characteristics limit is strongly recommended for normal operation. If these electrical characteristic conditions are exceeded during normal operation, the ILI9481 will malfunction and cause poor reliability.

Item	Symbol	Unit	Value	Note
Power supply voltage	IOVCC	V	-0.3 ~ +4.6	1,
Power supply voltage	VCI - GND	V	-0.3 ~ +4.6	2
Power supply voltage	DDVDH - GND	V	-0.3 ~ +6.5	3
Power supply voltage	GND -VCL	V	-0.3 ~ +4.6	4
Power supply voltage	DDVDH - VCL	V	-0.3 ~ +9.0	
Power supply voltage	VGH - GND	V	-0.3 ~ +18.5	
Power supply voltage	GND - VGL	V	-0.3 ~ +18.5	
Power supply voltage	VGH - VGL	V	-0.3 ~ +32	
Input voltage	Vt	V	-0.3 ~ IOVCC+ 0.3	
Operating temperature	Topr	°C	-40 ~ +85	8, 9
Storage temperature	Tstg	°C	-55 ~ +110	8, 9

Notes:

1. Make sure IOVCC ≥ GND
2. Make sure VCI ≥ AGND.
3. Make sure DDVDH ≥ VCL and DDVDH ≥ VCI
4. Make sure AGND ≥ VGL.

Table 3

4.2 DC Characteristics

Parameter	Symbol	Condition	Min.	Typ.	Max.	Unit
Analog Power Supply Voltage	VCI	Analog Operation Voltage	2.5	2.8	3.3	V
I/O pin Power Supply Voltage	IOVCC	I/O pin Operation Voltage	1.65	2.8	3.3	V
Logic High level input voltage	V _{IH}	IOVCC = 1.65V ~ 3.3V	0.7*IOVCC	-	IOVCC	V
Logic Low level input voltage	V _{IL}	IOVCC = 1.65V ~ 3.3V	0.0	-	0.3*IOVCC	V
Logic High level Output voltage	V _{IH}	I _{out} = -1 mA	0.8*IOVCC	-	IOVCC	V
Logic Low level Output voltage	V _{IL}	I _{out} = +1 mA	0.0	-	0.2*IOVCC	V
Logic High level input current	I _{IHD}	D[17:0]			10	uA
Logic Low level input current	I _{ILD}	D[17:0]	-10			uA

Table 4



4.3 Environmental Condition

Table 5

Item	Operating temperature (Topr)		Storage temperature (Tstg) (Note 1)		Remark
	Min.	Max.	Min.	Max.	
Ambient temperature (Ta)	-20°C	+70°C	-30°C	+80°C	Dry
Humidity (Note 1)	90% max. RH for $T_a \leq 40^\circ\text{C}$ < 50% RH for $40^\circ\text{C} < T_a \leq \text{Maximum}$ operating temperature			No condensation	
Vibration (IEC 68-2-6) cells must be mounted on a suitable connector	Frequency: 10 ~ 55 Hz Amplitude: 0.75 mm Duration: 20 cycles in each direction.			3 directions	
Shock (IEC 68-2-27) Half-sine pulse shape	Pulse duration: 11 ms Peak acceleration: $981 \text{ m/s}^2 = 100\text{g}$ Number of shocks: 3 shocks in 3 mutually perpendicular axes.			3 directions	

Note 1: Product cannot sustain at extreme storage conditions for long time.



5. Electrical Specifications

5.1 Typical Electrical Characteristics

At Ta = 25 °C, VDD = 2.8V, GND = 0V.

Table 6

Parameter	Symbol	Conditions	Min.	Typ.	Max.	Unit
Supply voltage (logic)	VDD-GND		2.7	2.8	2.9	V
Supply voltage (for analog power supply)	VDI		-	-	-	V
TFT gate ON voltage	VGH(Note 2)	At Ta=25°C±5°C (Note 4)	-	15	-	V
TFT gate OFF voltage	VGL(Note 3)		-	-10	-	V
TFT common electrode voltage	VcomH		2.5	-	4.0	V
	VcomL	-1.5	-	0	V	
Input signal voltage	V _{IH}	"H" level, VDD= 2.8V	0.8xIOVCC	-	IOVCC	V
	V _{IL}	"L" level, VDD= 2.8V	-0.3	-	0.2xIOVCC	V
Supply current(logic & LCD)	IDD	VDD=2.8V	-	TBD	-	mA
Supply voltage of white LED backlight	VLED	Forward current =90mA	-	3.2	-	V
Luminance (on the backlight surface)			Number of LED dies = 6	-	3500	-

Note (1): There is tolerance in optimum LCD driving voltage during production and it will be within the specified range.

Note (2): VGH is TFT Gate operating voltage.

Note (3): VGL is TFT Gate operating voltage.

The low voltage level VGL signal must be fluctuates with same phase as Vcom in case of Cadd (Storage on Gate) structure.

Note (4): Vcom must be adjusted to optimize display quality.

5.2 Timing Specification

5.2.1 DBI Type B (18/16/9/8 bit) Interface Timing Characteristics

Table 7

Signal	Symbol	Parameter	min	max	Unit	Description
D/CX	t _{ast}	Address setup time	10	-	ns	For maximum CL=30pF For minimum CL=8pF
	t _{aht}	Address hold time (Write/Read)	10	-	ns	
CSX	t _{cs}	Chip Select setup time (Write)	20	-	ns	
	t _{rcs}	Chip Select setup time (Read)	20	-	ns	
	t _{csf}	Chip Select Wait time (Write/Read)	20	-	ns	
WRX	t _{wc}	Write cycle	100	-	ns	
	t _{wrh}	Write Control pulse H duration	30	-	ns	
	t _{wrl}	Write Control pulse L duration	20	-	ns	
RDX	t _{rc}	Read cycle	450	-	ns	
	t _{rdh}	Read Control pulse H duration	250	-	ns	
	t _{rdl}	Read Control pulse L duration	170	-	ns	
DB[17:0], DB[15:0], DB[8:0], DB[7:0]	t _{wds}	Write data setup time	15	-	ns	
	t _{wdh}	Write data hold time	25	-	ns	
	t _{racc}	Read access time	10	340	ns	
	t _{rod}	Read output disable time	10	-	ns	

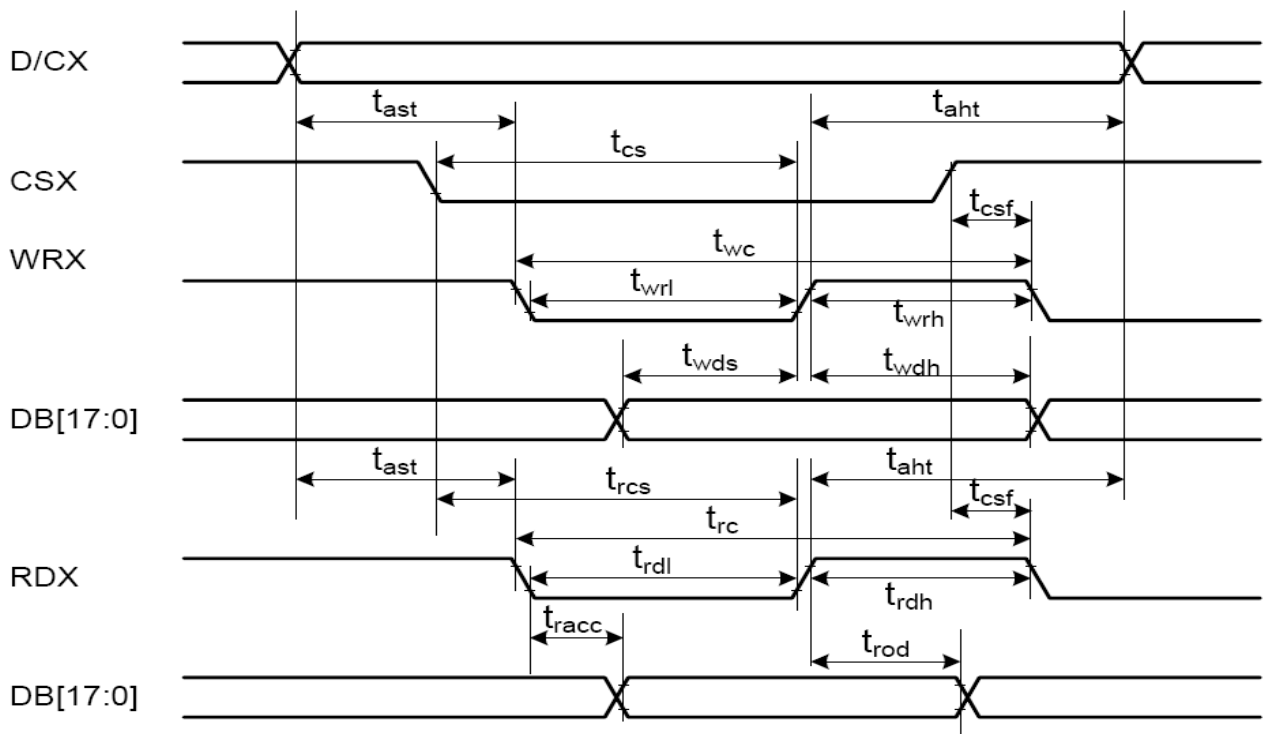

Figure 3:16-bit Interface Timing



6. Optical Characteristics (for TFT panel only)

Table 8: Optical specifications

Items	Symbol	Condition	Specifications			Unit	Note	
			Min.	Typ.	Max.			
Transmittance	T%	Viewing normal angle $\theta = \phi = 0^\circ$	-	6.0	-	%	Reference Only	
Contrast Ratio	CR		150	200	-	-		
Response Time	TR		-	15	30	ms		
	TF		-	35	50	ms		
Chromaticity	Red		XR	-	TBD	-		-
			YR	-	TBD	-		-
	Green		XG	-	TBD	-		-
			YG	-	TBD	-		-
	Blue		XB	-	TBD	-		-
			YB	-	TBD	-		-
	White	XW	-	TBD	-	-		
		YW	-	TBD	-	-		
Viewing angle	Hor.	ϕ_{x+} (3 o'clock)	-	45	-	deg.		
		ϕ_{x-} (9 o'clock)	-	45	-			
	Ver.	θ_{y+} (12 o'clock)	-	35	-			
		θ_{y-} (6 o'clock)	-	15	-			



6.1 Definitions and measuring methods

[1] Transmittance (T%)

The transmittance of the panel including polarizers is measured without electrical driving.

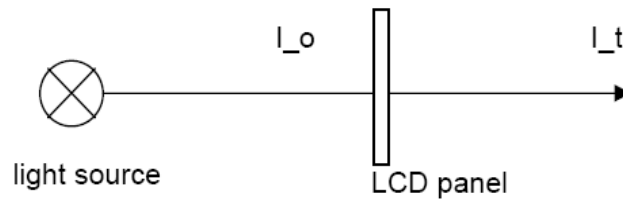

The Transmittance is defined as:

$$Tr = \frac{I_t}{I_o} \times 100\%$$

here,

I_o : the brightness of the light source.

I_t : the brightness after panel transmission.

[2] Response Time(T_r , T_f)

The rise time ' T_r ' is defined as the time for luminance to change from 90% to 10% as a result of a change of the electrical condition. The fall time ' T_f ' is defined as the time for luminance to change from 10% to 90% as a result of a change of the electrical condition.

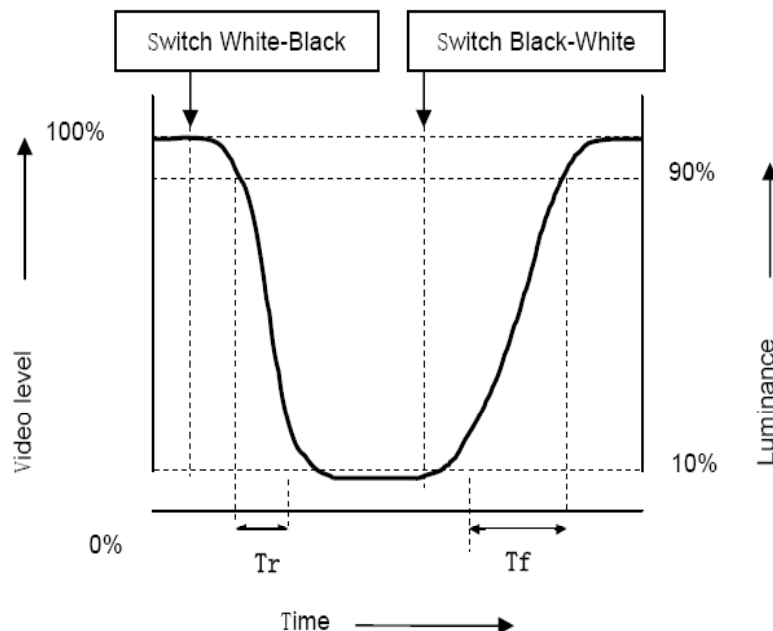



[3] Contrast ratio (Cr)

The contrast ratio (Cr), measured on a module, is the ratio between the luminance (L_w) in a full white area ($R=G=B=1$) and the luminance (L_d) in a dark area ($R=G=B=0$):

$$Cr = \frac{L_w}{L_d}$$

[4] Viewing angle diagram

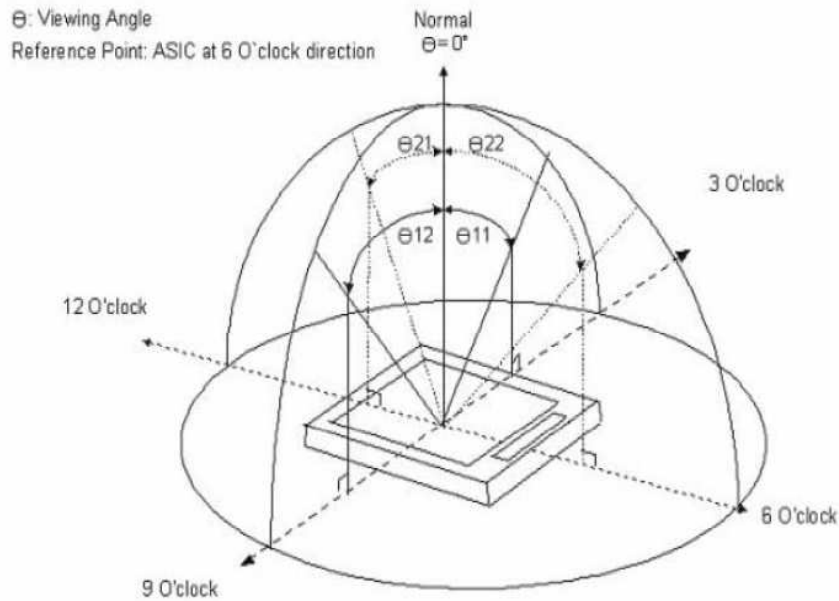

[5] Definition of color gamut

Measuring machine: CFT-01. NTSC'S Primaries: $R(x,y,Y)$ 、 $G(x,y,Y)$ 、 $B(x,y,Y)$.

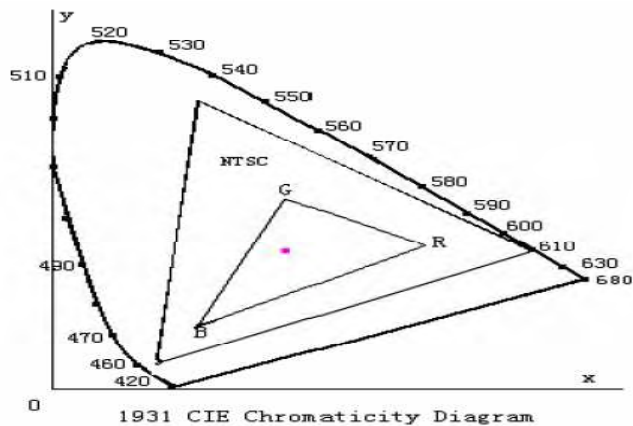

Fig. 1931 CIE chromaticity diagram

Color gamut: $S = \frac{\text{Area of RGB triangle}}{\text{Area of NTSC triangle}} \times 100\%$



7. TFT Panel Inspection Specifications

Failure mode	Illustration	Category (Unit: mm)		Acceptable count	
				Viewing area	Non-Viewing area
Black spot White spot	<p>$\Phi = (Length+width)/2$</p>	A	$\Phi \leq 0.10$	Not count	Not count
		B	$0.10 < \Phi \leq 0.15$	The gap between the two spots should be 5 mm and above. After divided the display into 9 zones with equal area, only 2 spots are acceptable in each zone.	
		C	$0.15 < \Phi \leq 0.25$	2	
		D	$0.25 < \Phi$	0	
Bright spot (Red spot, green spot and blue spot caused by damaged colour filter)		A	Area ≤ 1 sub-pixel	The gap between the two spots should 5 mm and above.	N/A
Black line White line		A	$W \leq 0.05$	Not count	Not count
		B	$0.05 < W \leq 0.08, L \leq 8.0$	2	
		C	$0.08 < W$ or $L > 8.0$	Judged by spot spec	

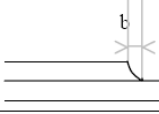
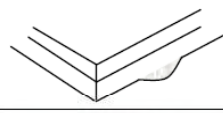
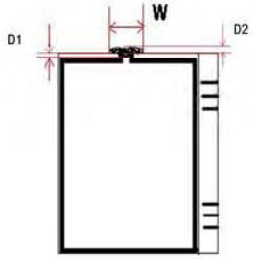
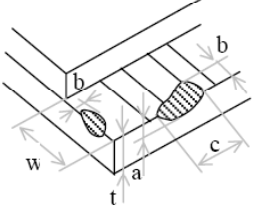
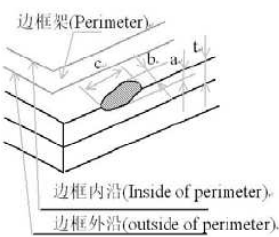
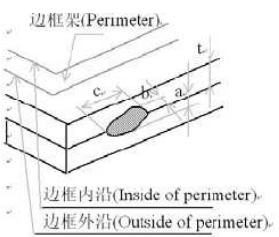
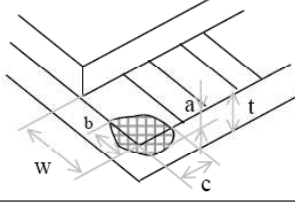

Below are cosmetic inspection specifications

Excess glass		$b \leq 1.0$, this defect shall not affect the outline dimension or assembly process. (Remarks: For COG process, the defect size is decided by the dimension of LCD panel.)	
		This defect shall not affect the outline dimension or assembly process.	
The depth of UV glue entered in LCD cell		a. $D1 \geq 0.2$, not enter into viewing area b. $D2 \leq 0.8$, c. $W = \text{End mouth width} + (2 \sim 6 \text{ mm})$	
Glass defect (scratch, damage)	1.) LCD ledge damage	Category	
		A	The defect shall not affect the outline dimension or assembly process at non ITO zone.
		B	$b \leq 1/4w$, a & c not count (at ITO zone)
		C	Alignment mark on LCD ledge shall not be damaged.
	2.) Outside of perimeter damage		
b can't reach inside of perimeter.			
3.) Joint glass damage			
b can't reach outside of perimeter or ITO layout.			
4.) Corner damage		A	$a \leq t, b \leq 3.0, c \leq 3.0$
B. Alignment mark on LCD ledge shall not be damaged.			
Remark: A stands for thickness of damage, b for width, c for length and t for glass thickness. (Unit: mm)			