

# Vacuum Fluorescent Display Module Specification

Model: GU112X16G-7003

Specification No:	DS-914-0001-04
Date Of Issue:	March 15, 2002
Revision:	April 11 , 2002 July 03, 2002 August 30, 2002 June 11, 2004

Published by  
NORITAKE ITRON CORP. / Japan  
<http://www.noritake-itron.jp>

This specification is subject to change without prior notice.

Index.

<b>1</b>	<b>General Description</b>	<b>3</b>
1.1	Scope	3
1.2	Construction	3
1.3	Outline	3
1.4	Block Diagram	3
<b>2</b>	<b>Electrical specification</b>	<b>4</b>
2.1	Absolute Maximum Ratings	4
2.2	Electrical ratings	4
2.3	Electrical Characteristics	4
<b>3</b>	<b>Optical Specifications</b>	<b>5</b>
<b>4</b>	<b>Environmental Specifications</b>	<b>5</b>
<b>5</b>	<b>Interface</b>	<b>5</b>
5.1	Type of interface	5
5.2	Serial interface	5
5.2.1	Basic function	5
5.2.2	Asynchronous serial interface timing	5
5.2.3	Synchronous serial interface timing	6
5.3	Reset timing	6
<b>6</b>	<b>Display specification</b>	<b>7</b>
6.1	Displayable image types	7
6.1.1	Graphic display	7
6.1.2	Character display	7
6.2	Display memory	7
6.3	Window	8
6.3.1	Base-Window	8
6.3.2	User-Window	8
6.4	Write screen mode for "Base Window"	9
6.4.1	Display screen mode (Scanning)	9
6.4.2	All screen mode (Scanning)	9
6.5	Character display format	10
<b>7</b>	<b>Function</b>	<b>11</b>
7.1	Commands	11
7.1.1	Character display	11
7.1.2	BS (Back Space)	12
7.1.3	HT (Horizontal Tab) – 1 character to right	12
7.1.4	LF (Line Feed)	13
7.1.5	HOM (Home Position)	14
7.1.6	CR (Carriage Return)	14
7.1.7	US \$ xL xH yL yH (Cursor Set)	14
7.1.8	CLR (Display Clear)	14
7.1.9	US C n (Cursor ON/OFF)	14
7.1.10	ESC@ (Initialize Display)	14
7.1.11	ESC % n (Specify Download Register)	15
7.1.12	ESC & a c1 c2 [x1 d1...d(a×x1)]...[xk d1...d(a×xk)] (Download character definition)	15
7.1.13	ESC ? a c (Delete downloaded character)	16
7.1.14	ESC R n (Specifies International font set)	16
7.1.15	ESC t n (Specifies character code type)	16
7.1.16	US MD1 (Over-write mode)	16
7.1.17	US MD2 (Vertical scroll mode)	17
7.1.18	US MD3 (Horizontal scroll mode)	17
7.1.19	US s n (Horizontal scroll speed)	17
7.1.20	US r n (Specifies or cancels reverse display)	17
7.1.21	US w n (Specifies write mixture display mode)	18
7.1.22	US X n (Brightness level setting)	18

7.1.23	US ( a n [parameter] ( <i>Display action command group</i> ).....	18
7.1.24	<Function 01H> US ( a n t ( <i>Wait</i> ) .....	18
7.1.25	<Function 10H> US ( a n wL wH cL cH s ( <i>Scroll display action</i> ) .....	19
7.1.26	<Function 11H> US ( a n p t1 t2 c ( <i>Display Blink</i> ) .....	19
7.1.27	<Function 12H> US ( a n p ( <i>Screen saver</i> ) .....	20
7.1.28	US ( f n [parameter] ( <i>Bit image display group</i> ) .....	20
7.1.29	<Function 11H> US ( f n xL xH yL yH g d(1)...d(k) .....	20
7.1.30	US ( g n [parameter] ( <i>Font command group</i> ) .....	21
7.1.31	<Function 03H> US ( g n w ( <i>Character display width</i> ) .....	21
7.1.32	<Function 40H> US ( g n x y ( <i>Font magnified display</i> ) .....	22
7.1.33	US ( w n [parameter] ( <i>Window command group</i> ) .....	22
7.1.34	<Function 01H> US ( w n a ( <i>Current Window select</i> ) .....	23
7.1.35	<Function 02H> US ( w n a b[xPL xPH yPL yPH xSL xSH ySL ySH] .....	23
7.1.36	<Function 10H> US ( w n a ( <i>Write screen mode select</i> (see sect. 6.3) .....	24
7.1.37	WINx ( <i>Short-Cut Current Window Select</i> ) .....	24
7.2	<i>Bit image data format</i> .....	25
<b>8</b>	<b>Setup</b> .....	<b>26</b>
8.1	<i>Jumper</i> .....	26
8.1.1	Baud rate select (Applying for Asynchronous serial interface).....	26
8.1.2	Serial interface select .....	26
<b>9</b>	<b>Connector</b> .....	<b>26</b>
9.1	<i>Serial interface connector (Six through holes)</i> .....	26
9.1.1	Case of Asynchronous serial interface is selected .....	26
9.1.2	Case of Synchronous serial interface is selected .....	26
<b>10</b>	<b>Notation of firmware version</b> .....	<b>27</b>
<b>11</b>	<b>Outline Drawing</b> .....	<b>28</b>
	<b>Notice for the Cautious Handling VFD Modules</b> .....	<b>29</b>
	<b>Revision Note</b> .....	<b>30</b>

# 1 General Description

## 1.1 Scope

This specification covers the operation and operating requirements of the vacuum fluorescent graphic display module GU112X16G-7003.

## 1.2 Construction

The module consists of a 112 x 16dot graphic BD-VFD, refresh RAM, character generator, DC/DC converter, display controller, and all necessary control logic. The module can simultaneously display graphic patterns and/or characters on the screen.

## 1.3 Outline

Power supply: + 5 V<sub>DC</sub> only  
 Interface: Serial interface (C-MOS Synchronous or Asynchronous, Selectable)  
 Function: Character display, 5x7, Attribution  
 (5x7Character font, refer to spec. of DS-898-0002-xx)  
 Graphic display  
 Control command  
 Character download function  
 Screen saver function

Applied reliability spec: TT-99-3102  
 Applied production spec:TT-98-3413

## 1.4 Block Diagram

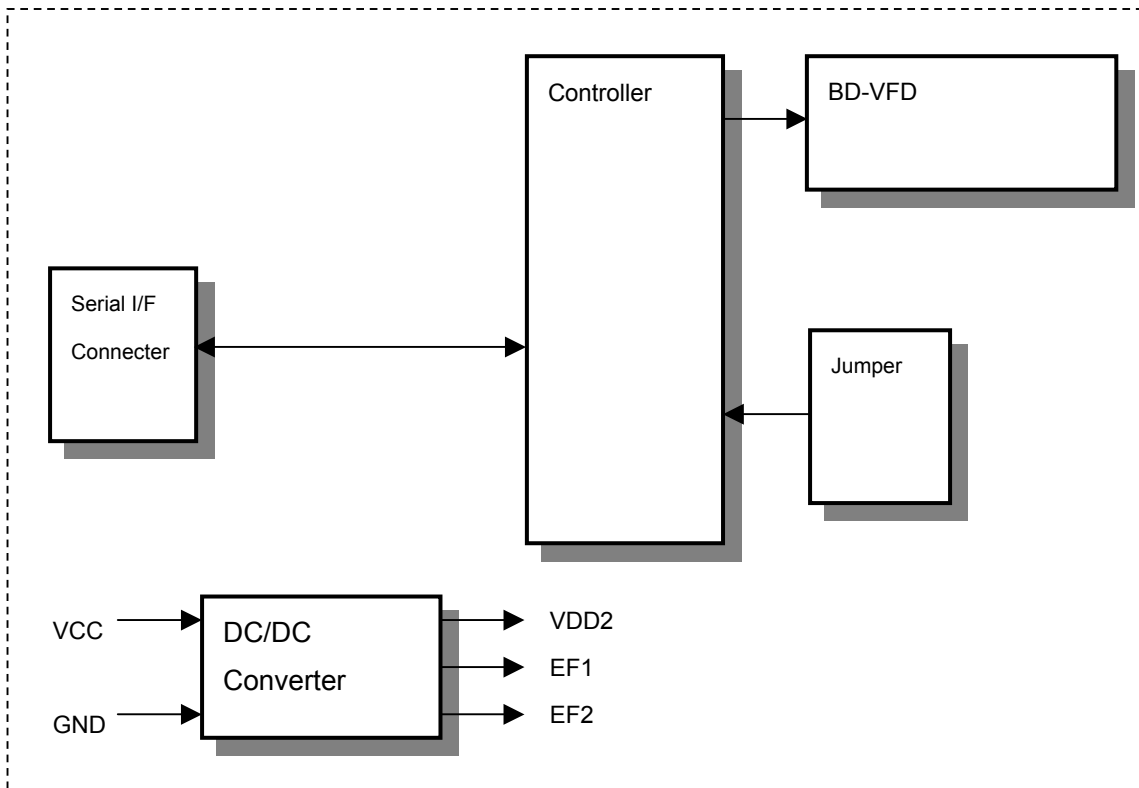

## 2 Electrical specification

### 2.1 Absolute Maximum Ratings

Parameter	Symbol	Min.	Typ.	Max.	Unit
Power Supply Voltage	VCC	-0.3	-	+6.0	VDC
Logic Supply Voltage SIN, SCK, /RESET	VIN	-0.3	-	Vcc+0.3	VDC

### 2.2 Electrical ratings

Parameter	Symbol	Min.	Typ.	Max.	Unit
Power Supply Voltage	VCC	4.75	5.0	5.25	VDC

All driving voltage for the VFD is converted from the DC/DC converter on board.

### 2.3 Electrical Characteristics

Measuring Conditions: Ambient temperature = 25degrees C, VCC =5.0VDC

Parameter	Symbol	Min.	Typ.	Max.	Unit	Condition	Note	
"L" Level Logic Input Current SIN, SCK, /RESET	IIL			-0.6	mA	VIN=0V		
"H" Level Logic Input Current SIN, SCK, /RESET	IIH	-	-	1.0	uADC	VIN=5V	-	
Logic Input Voltage SIN, SCK, /RESET	"H"	VIH	0.8VCC	-	VCC	-	-	
	"L"	VIL	0	-	0.2VCC	VDC	-	
Logic Output Voltage SBUSY,	"H"	VOH	3.8	-	VCC	VDC	IOH=-1.5mA	-
	"L"	VOL	0	-	0.6	VDC	IOL=1.6mA	-
Power Supply Current 1	ICC1	-	260	340	mADC	-	(1)	
Power Supply Current 2	ICC2	-	220	290	mADC	-	(2)	
Power Supply Current 3	ICC3	-	35	45	mADC	-	(3)	

#### Note

(1),(2) Icc1 shows the current at all dots in the screen are lighted and Icc2 at all dots off. At power on rush, more than 2times current of above table should be expected. Provide the quick rise type power supply (<100msec.).

(3)Icc3 shows the current at Power OFF Mode (Power save mode).

### 3 Optical Specifications

Number of dots:	1,792 (112 x 16)
PCB Size:	80.0 mm x 36.0 mm (X x Y)
Display area:	52.5mm x 11.45mm(X x Y)
Dot size:	0.33mm x 0.575mm(X x Y)
Dot pitch:	0.47mm x 0.725mm (X x Y)
Luminance:	350cd/m <sup>2</sup> Min. (700cd/m <sup>2</sup> Typ.)
Color of illumination:	Green (Blue Green)

### 4 Environmental Specifications

Operating temperature:	-40 to +85degrees C
Storage temperature:	-40 to +85degrees C
Storage humidity:	20 to 80 % R.H(Non Condensing)
Vibration:	10-55-10Hz, all amplitude 1mm, 30Min., X-Y-Z (Non operating)
Shock:	392m/s <sup>2</sup> (40G) 9mS X-Y-Z, 3times each direction (Non operating)

### 5 Interface

#### 5.1 Type of interface

The following interfaces are available on this module;  
 Serial interface (C-MOS Synchronous or Asynchronous, Selectable)

#### 5.2 Serial interface

##### 5.2.1 Basic function

There are two Serial interfaces: C-MOS Synchronous or Asynchronous and they are Selectable by jumper. The module sets the SBUSY line upon receipt of data, and clears the line when ready to receive more data.

##### 5.2.2 Asynchronous serial interface timing

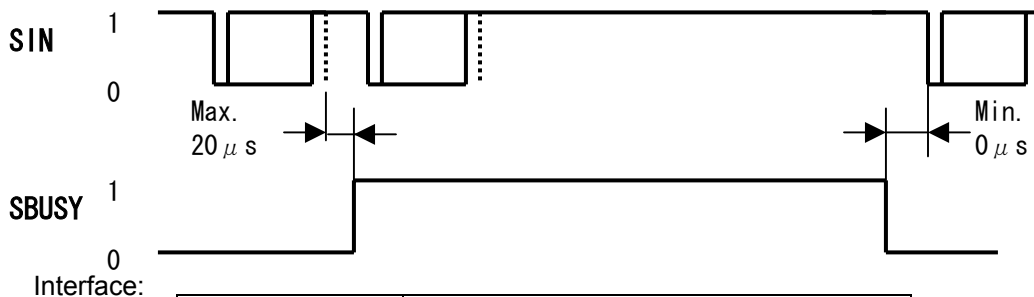

Interface:

<b>Baud rate</b>	9,600 ~ 115,200bps (Selectable by Jumper)
<b>Parity</b>	None parity
<b>Format</b>	Start (1bit)+ Data (8bit)+ Stop (1bit)
<b>Handshake</b>	SBUSY

Receiving Buffer Capacity: 12 byte

SBUSY change timing:

SBUSY	1(BUSY)	0(READY)
Condition	When there is data in buffer	When there is no data in buffer

Data can be stored into receiving buffer. However, it recommends not sending the data when SBUSY=1.

### 5.2.3 Synchronous serial interface timing

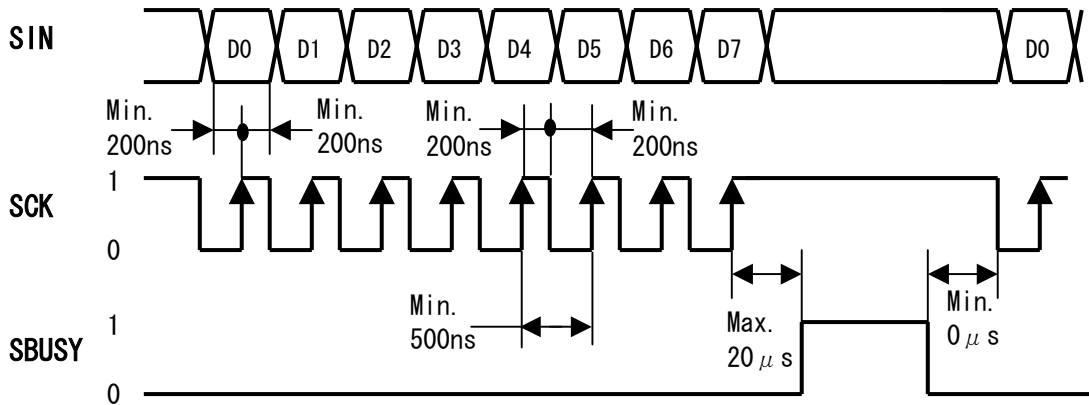

Receiving Buffer Capacity: 12 byte

SBUSY change timing:

SBUSY	1(BUSY)	0(READY)
Condition	When there is data in buffer	When there is no data in buffer

Data can be stored into receiving buffer. However, it recommends not sending the data when SBUSY=1.

### 5.3 Reset timing

Reset pulse (active low) should be longer than 1mS.

The module sets the SBUSY line upon receipt of Reset signal and clears the line when ready to receive the data.

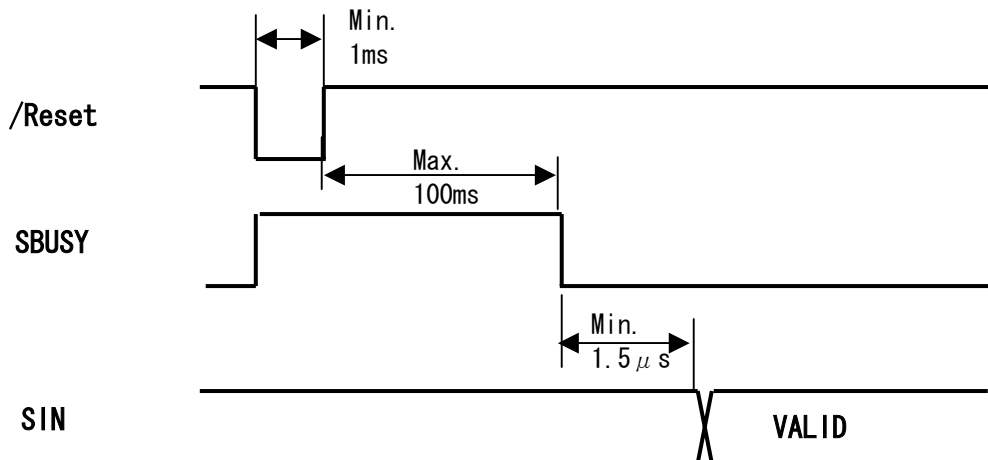

## 6 Display specification

### 6.1 Displayable image types

#### 6.1.1 Graphic display

Number of dot: 112 x 16 dots

#### 6.1.2 Character display

Character mode: 5 x 7 dot

Character font type: 5 x 7 dot - Characters, ANK, international font

Character display width: Fixed character format 1 & 2, Proportional character format 1 & 2.

Attribution: Character magnify, Reverse

### 6.2 Display memory

Size: 512x 16 dots - separated as: Display area (112x16dots)

Hidden area (400x16dots).

Hidden area also can be displayed by using "Display action command group" Refer to "Display action command group", Page 18.

By using "User Window" function, All display area can be separated, and each window separated can be controlled independently.

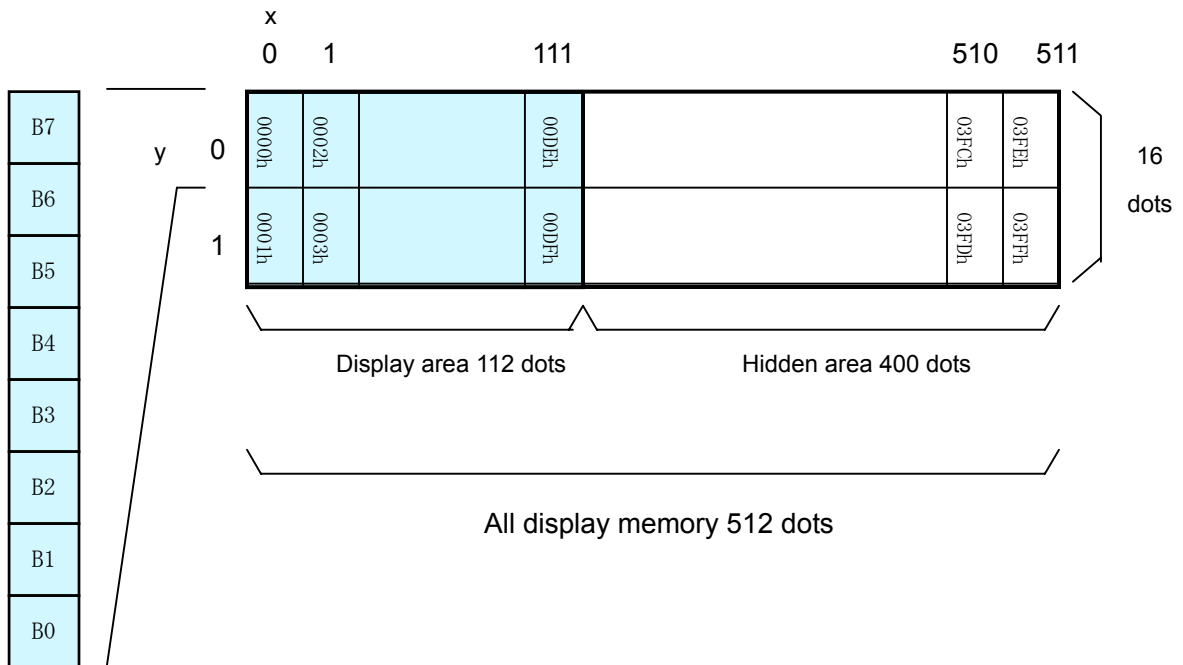



**6.3 Window**

Window function divides display screen as “Window” ,and each divided “Window” can be controlled and displayed independently. Refer to “Window command group”, Page 23.

There is no independed display memories for each “Window”.

There are 2 types of “Window”, Base-Window and User-Window .

**6.3.1 Base-Window**

This has the whole display screen and if User-Window is not defined, all display operation is processed under this Base-Window.

When some User-Window is defined, the display operation to the out of display screen of User-Window should be processed under Base-Window.

When Base-Window is selected even if some User-Window is defined, all of display operation is processed under Base-Window. Therefore, the current display pattern of User-Window is overwritten.

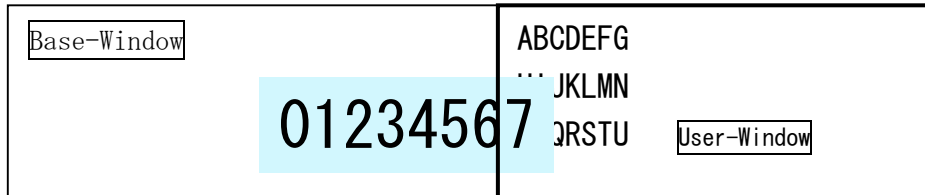

**6.3.2 User-Window**

User-Window is defined by command, and display operation can be processed on User-Window selected by “Current Window select” command.

User-Window can be defined up to 4 windows.

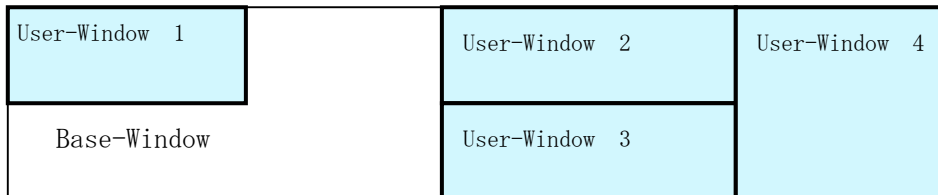

**6.4 Write screen mode for “Base Window”**

**This effects only for Base Window.**

There are two types of Write screen mode, Display screen mode and All screen mode which can be changed by command. (Refer to Window command group , “Write screen mode select”,Page 25)

**6.4.1 Display screen mode (Scanning)**

When the cursor is located on the Display area, all of operation will be done within Display area, and when cursor is located on the Hidden area, it will be done within Hidden area.

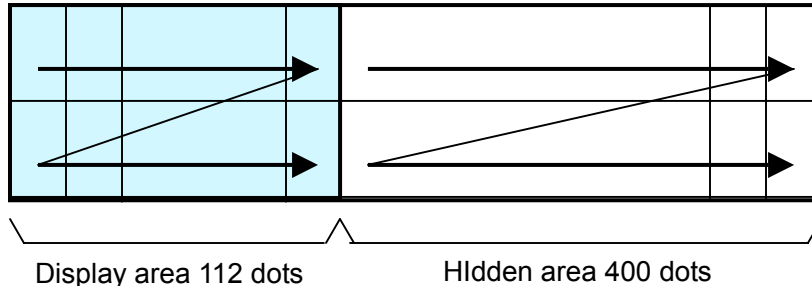

**6.4.2 All screen mode (Scanning)**

All of operation will be done on all of area.

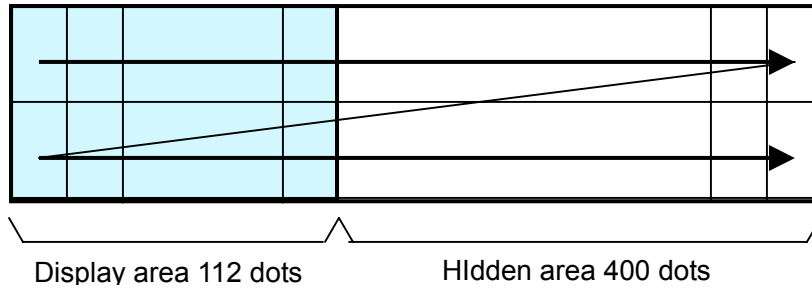

### 6.5 Character display format

Character display format is following selectable by “Character display width” command.

Type of character	Display position	Format	Fixed character width 1	Fixed character width 2	Proportional character width 1	Proportional character width 2
Standard character and Download character 5x7dot	Y=0 (Top line)	Character format	5 x 7	5 x 7	n x 7	n x 7
		Upper space	0	0	0	0
		Lower space	1	1	1	1
		Left space	0	1	0	1
		Right space	1	1	1	1
	Y=1 (Bottom line)	Character format	5 x 7	5 x 7	n x 7	n x 7
		Upper space	1	1	1	1
		Lower space	0	0	0	0
		Left space	0	1	0	1
		Right space	1	1	1	1
Download character 7x8	Y=0 (Top line)	Character format	6 x 8 *	7 x 8	6 x 8 *	7 x 8
		Upper space	0	0	0	0
	Y=1 (Bottom line)	Lower space	0	0	0	0
		Left space	0	0	0	0
		Right space	0	0	0	0

\* The most left part of 6x8 dot within 7x8 dot is displayed.

Note: In case of proportional character width is specified, the blank character (20H) will be operated as same as 2 dot width character.

Fixed character width 1

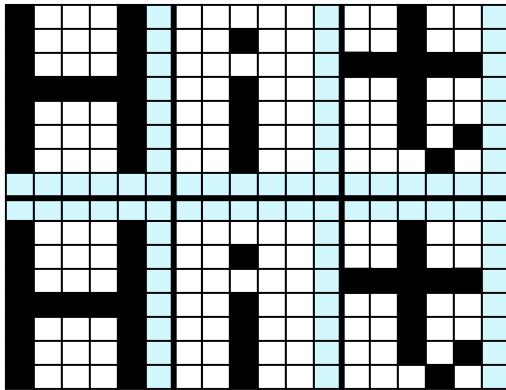

Fixed character width 2

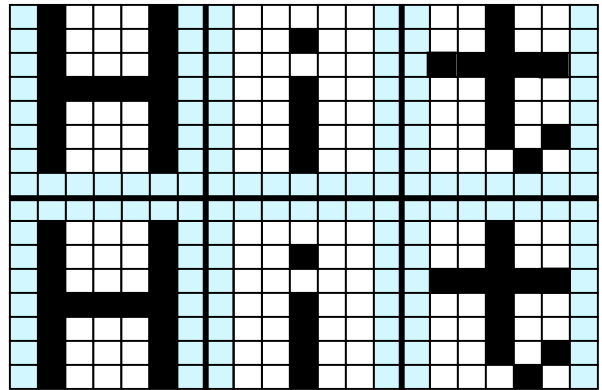

Proportional character width 1

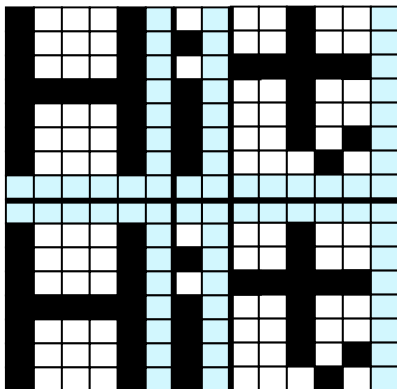

Proportional character width 2

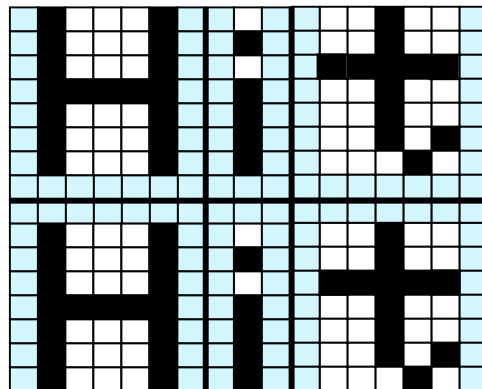

## 7 Function

### 7.1 Commands

The details of each command as follows;

Note: The size of character (X x Y dot) described in this section is depending on the command of “Character display width” or “Font magnified display”.

Number of X dot and Y dot for 1 character width for each commands except “Character display” under the condition of each character display width are as follows;

Character type	Fixed character width 1	Fixed character width 2	Proportional character width 1	Proportional character width 2
Number of X dot	5 + 1	5 + 2	5 + 1	5 + 2
Number of Y dot	7 + 1	7 + 1	7 + 1	7 + 1

#### 7.1.1 Character display

**Code: 20H – FFH**

Name: Character display

Function: Display the character on cursor position.

This command effects on the current window selected by “Current window select”.

When MD1 mode is selected.

Cursor position		Operation
X direction	Y direction	
The space for 1 character size is in right side.	-	Display >> HT
Right end	The space for one line is in the lower side.	HT >> Display >> HT
	The space for one line is NOT in the lower side.	HT >> Display >> HT

When MD2 mode is selected.

Cursor position		Operation
X direction	Y direction	
The space for 1 character size is in right side.	-	Display >> HT
Right end	The space for one line is in the lower side.	HT >> Display >> HT
	The space for one line is NOT in the lower side.	HT >> Display >> HT

When MD3 mode is selected.

Cursor position		Operation
X direction	Y direction	
The space for 1 character size is in right side.	-	Display >> HT
Right end	-	HT >> Display >> HT

**7.1.2 BS (Back Space)****Code: 08H**

Function: The cursor moves to left by one character.

This command effects on the current window selected by "Current window select".

When MD1 and 2 modes is selected.

Cursor position		Operation
X direction	Y direction	
The space for 1 character size is in left side.	-	The cursor moves to left by one character.
Left end	The space for one line is in the lower side.	The cursor moves to the right end of one upper line.
	The space for one line is NOT in the lower side.	The cursor does not move.

When MD3 mode is selected.

Cursor position		Operation
X direction	Y direction	
The space for 1 character size is in left side.	-	The cursor moves to left by one character.
Left end	-	The cursor does not move.

**7.1.3 HT (Horizontal Tab) – 1 character to right****Code: 09H**

Function: The cursor moves to right by one character. This command effects on the current window selected by "Current window select". The detail of operation is:

When MD1 mode is selected.

Cursor position		Operation
X direction	Y direction	
The space for 1 character size is in right side.	-	The cursor moves to right by one character.
Right end	The space for one line is in the lower side.	The cursor moves to the left end of one lower line.
	The space for one line is NOT in the lower side.	The cursor moves to the left end of top line.

When MD2 mode is selected.

Cursor position		Operation
X direction	Y direction	
The space for 1 character size is in right side.	-	The cursor moves to right by one character.
Right end	The space for one line is in the lower side.	The cursor moves to the left end of one lower line.
	The space for one line is NOT in the lower side.	All displayed pattern is scrolled up to one upper line, displayed pattern of lowest line is cleared. And cursor moves to left end of bottom line.

When MD3 mode is selected.

Cursor position		Operation
X direction	Y direction	
The space for 1 character size is in right side.	-	The cursor moves to right by one character.
Right end	-	The displayed pattern on cursor line is scrolled to left by one character, Right end character is cleared, and cursor moves to the right end.

**7.1.4 LF (Line Feed)**

**Code: 0AH**

Function: The cursor moves to one lower line. This command effects on the current window selected by "Current window select". The detail of operation is as follows;

When MD1 modes is selected.

Cursor position		Operation
X direction	Y direction	
-	The space for one line is in the lower side.	The cursor moves to the same position of one lower line.
	The space for one line is NOT in the lower side.	The cursor moves to the left end of top line.

When MD2 mode is selected.

Cursor position		Operation
X direction	Y direction	
-	The space for one line is in the lower side.	The cursor moves to the same position of one lower line.
	The space for one line is NOT in the lower side.	All of displayed pattern is scrolled to one upper line, and displayed pattern of bottom line is cleared. The cursor does not move.

When MD3 mode is selected.

Cursor position		Operation
X direction	Y direction	
-	-	The cursor does not move.

**7.1.5 HOM (Home Position)****Code: 0BH**

Function: The cursor moves to the home position. This command effects on the current window selected by "Current window select".

**7.1.6 CR (Carriage Return)****Code: 0DH**

Function: The cursor moves to left end of same line. This command effects on the current window selected by "Current window select".

**7.1.7 US \$ xL xH yL yH (Cursor Set)****Code: 1FH 24H xL xH yL yH**

xL: Cursor position x Lower byte (1 dot/unit)

xH: Cursor position x Upper byte (1 dot/unit)

yL: Cursor position y Lower byte (8 dot/unit)

yH: Cursor position y Upper byte(8 dot/unit)

Definable area:  $0 \leq (xL + xH \times 255) \leq 511$   
 $0 \leq (yL + yH \times 255) \leq 1$

Function: The cursor moves to specified X, Y position on display memory. If the specified X, Y position (X, Y, either or both) is over range, the command is ignored, and keep same cursor position.

This command effects on the current window selected by "Current window select".

**7.1.8 CLR (Display Clear)****Code: 0CH**

Function: The display screen is cleared and the cursor moves to home position after this command was executed. This command effects on the current window selected by "Current window select".

**7.1.9 US C n (Cursor ON/OFF)****Code: 1F 43H n**

n: Display cursor ON/OFF select

n = 0 : Cursor OFF

n = 1 : Cursor ON

Default: n = 0

Function: Select cursor ON or OFF.

When cursor display ON is selected, the cursor position is displayed by 1x8 dots.

**7.1.10 ESC@ (Initialize Display)****Code: 1BH 40H**

Returns to default.

DIP Switch is not re-loaded.

The contents of receiving buffer remain in memory.

**7.1.11 ESC % n (Specify Download Register)**

**Code:** 1BH 25H n

Function: Specify enable or disable for download character.

n = 1: Enable (If download character is not defined, built-in character is displayed)

n = 0: Disable (Characters already downloaded, defined, and displayed are not affected)

**7.1.12 ESC & a c1 c2 [x1 d1...d(a×x1)]...[xk d1...d(a×xk)] (Download character definition)**

**Code:** 1Bh 26h a c1 c2 [x1 d1...d(a×x1)]...[xk d1...d(a×xk)]

a: Select character type

c1: Start character code

c2: End character code

x: Number of dot for X direction

d: Defined data (See sect. 7.3 - Download character format)

**Definable area:**

a = 1

x = 5: 5x7 dot font

x = 7: 7x8 dot font

$32 \leq c1 \leq c2 \leq 255$

$0 \leq d \leq 255$

x = 5: Upper 7 bit is valid.

x = 7: All 8 bit is valid.

$k = c2 - c1 + 1$

**Function:** To define download characters into RAM.

A maximum of 16 characters may be downloaded and defined.

x=5 : Defined by 5x7dot, and 5x7 dot character regulated upper and lower space is displayed as same as standard character display.

x=7 : Defined by 7x8 dot, and 6x8 or 7x8 dot character unrelated to space is displayed.

After the first 16 are defined, any additional characters required must replace one already defined. Downloaded characters are valid until they redefined, an initialize (ESC@) sequence is executed, or the power is turned off. To display the download character, execution of "Download character definition" and "Specify download character" is required. In case of displaying download character is re-defined, displaying character is not changed, new download character is applied from new data.

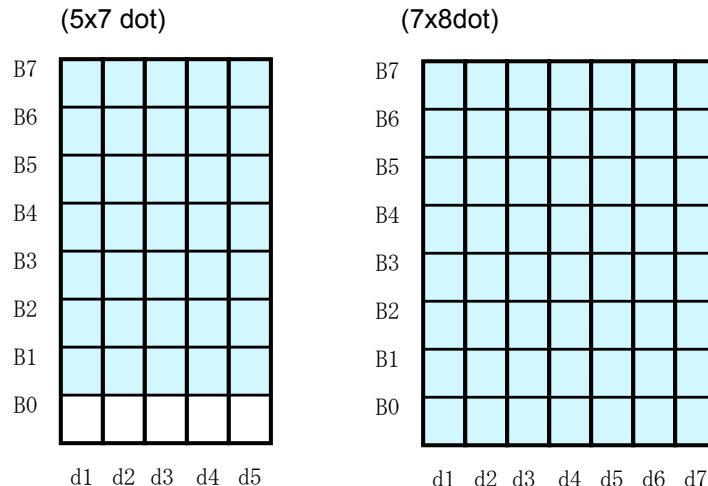



**7.1.13 ESC ? a c (Delete downloaded character)**

**Code:** 1BH 3FH a c  
 a: Select character  
 c: Character code for delete  
 Definable area: a = 1  
 32 ≤ c ≤ 255

**Function:** Delete defined download character.  
 The built-in chracter is displayed after this command is excuted.  
 It does not affect to the displaying download character.  
 This command is ignored if character code for download character is not defined.

**7.1.14 ESC R n (Specifies International font set)**

**Code:** 1BH 52H n  
 Definable area: 0 ≤ n ≤ 13  
 Default: n=0  
 Function: Select international font set.

n	Font set
0	America
1	France
2	Germany
3	England
4	Denmark 1
5	Sweden
6	Italy
7	Spain1
8	Japan
9	Norway
10	Denmark2
11	Spain2
12	Latin America
13	Korea

**7.1.15 ESC t n (Specifies character code type)**

**Code:** 1BH 74H n  
 Definable area: n = 0, 1, 2, 3, 4, 5, 16, 17, 18, 19  
 Default: n = 0  
 Function: Selects font code

n	Font code type
0	PC437(USA – Euro std)
1	Katakana – Japanese
2	PC850 (Multilingual)
3	PC860 (Portuguese)
4	PC863 (Canadian-French)
5	PC865 (Nordic)
16	WPC1252
17	PC866 (Cyrillic #2)
18	PC852 (Latin 2)
19	PC858

**7.1.16 US MD1 (Over-write mode)**

**Code:** 1FH 01H  
 Function: Over-writes, or replaces existing data.

This command effects on the current window selected by “Current window select” .

**7.1.17 US MD2 (Vertical scroll mode)**

**Code:** 1FH 02H

**Function:** Scrolls cursor up 1 line

This command effects on the current window selected by “Current window select” .

**Note:** If graphic image and character display is shown together on the same window, and specify this mode on that window, it may cause irregular graphic image. Please do not apply this command to the window showing such mixture display.

**7.1.18 US MD3 (Horizontal scroll mode)**

**Code:** 1FH 03H

**Function:** Scrolls cursor horizontally 1 space

This command effects on the current window selected by “Current window select” .

**7.1.19 US s n (Horizontal scroll speed)**

**Code:** 1FH 73H n

**Definable area:**  $0 \leq n \leq 31$

**Default:** n = 0

Note that until scrolling action is ended, new command(s) will not excuted. Scroll base speed “T” is depending on write screen mode, character size selected.

If n=0 is specified, scrolling is appeared by character n	Speed
0	By Character
1	T msec / 2dots
2 – 31	(n-1) × T msec / dot

**7.1.20 US r n (Specifies or cancels reverse display)**

**Code:** 1FH 72H n

n : Specify or cancel reverse character and graphic display

Definable area:  $0 \leq n \leq 1$

n=0: Cancel reverse mode

n=1: Specify reverse mode

Default: n=0

**Note:** This command is valid to the new data after this command is specified. This does not affect the contents already displayed.

**7.1.21 US w n (Specifies write mixture display mode)**

**Code: 1FH 77H n**

- n : Specif display write mode
- Definable area:  $0 \leq n \leq 3$
- n = 0: Normal display write. (Not mixture display)
- n = 1: OR display write
- n = 2: AND display write
- n = 3: EX-OR display write
- Default: n = 0

Function: Specifies write mixture mode. The new character or graphic image display mixed with current display image stored in display memory is overwritten to the display memory.

**7.1.22 US X n (Brightness level setting)**

**Code: 1FH 58H n**

- n : Brightness level setting
  - Definable area:  $1 \leq n \leq 8$
  - Default: n=8
  - Function: Specify brightness level of whole display screen.
- |   |       |
|---|-------|
| n | Level |
| 1 | 12.5% |
| 2 | 25%   |
| 3 | 37.5% |
| 4 | 50%   |
| 5 | 62.5% |
| 6 | 75%   |
| 7 | 87.5% |
| 8 | 100%  |

**7.1.23 US ( a n [parameter] (Display action command group)**

Function: Execute processing of display action command.

n	Function No.	Function
01H	Function 01H	Wait
10H	Function 10H	Scroll display action
11H	Function 11H	Blink display action
40H	Function 40H	Screen saver

n: specify function code.

The next command or data is not excuted until display action processing is ended.

**7.1.24 <Function 01H> US ( a n t (Wait)**

**Code: 1FH 28H 61H 01H t**

- n: Classify command
- t: Wait time
- Definable area: n = 01H
- $0 \leq t \leq 255$

Note: Wait time, define, command, and data processing are stopped while waiting by this command. Wait time = t X approx. 0.5sec

**7.1.25 <Function 10H> US ( a n wL wH cL cH s (Scroll display action)**

**Code:** 1FH 28H 61H 10H wL wH cL cH s

- n : Classify command
- wL: Display screen shift ,number of upper byte.
- wH: Display screen shift ,number of lower byte.
- cL: Number of reptition lower byte
- cH: Number of reptition upper byte
- s: Scroll action speed

Definable area: n = 10H

$$0 \leq (wL + wH \times 256) \leq 1023$$

$$0 \leq (cL + cH \times 256) \leq 65535$$

$$0 \leq s \leq 255$$

Function: Shift the display screen.

Horizontal scrolling can be possible by specifying the shift byte to multiple number of (Display screen “y” dot /8). Display swiching can be possible by specify shift byte to (Display screen “x” dot x Display screen “y” dot /8). Scroll speed is specified by “s”. Scroll speed: s X approx. 14msec/1 shift

For example: 1dot scroll to the left: sL=02H, sH=00H

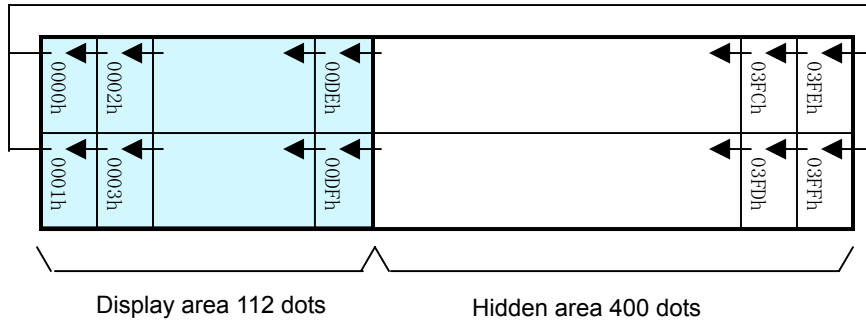

**7.1.26 <Function 11H> US ( a n p t1 t2 c (Display Blink)**

**Code:** 1FH 28H 61H 11H p t1 t2 c

- n: Classify command
- p: Blink pattern
- t1: Normal display time
- t2: Brank or Reverse display time
- c: Number of reptition

Definable area: n = 11H

$$0 \leq p \leq 2$$

p=0: Nomal display.

P=1: Repeat blink display with nomal and Brank display

P=2: Repeat blink display with nomal and Reverse display

$$1 \leq t1 \leq 255$$

$$1 \leq t2 \leq 255$$

$$1 \leq c \leq 255$$

Function: Blink display action Blink pattern specified by “p”.  
 Time specified by “t1”, “t2”, and repeat Blink display  
 A : t1 X approx.14msec Nomal display  
 B: t2 X approx. 14msec Brank or Reverse display

This command does not affect to display memory.

If c=0 is specified, brink display is repeated until when c=1 – 255 or Initialize command is specified, and the command/data execution is continued during display blinking.

If c=1 – 255 is specified, brink display is repeated 1-255 times, and the command/data execution is stopped. After display blinking is ended, return to nomal display and command/data execution is re-started.

**7.1.27 <Function 12H> US ( a n p (Screen saver)**

**Code: 1FH 28H 61H 40H p**

n: Classify command

p: Screen saver mode

Definable area: n = 40H

$0 \leq p \leq 4$

p=0: Power OFF (All dot OFF, Power save mode)

p=1: Power ON (All dot ON)

p=2: All dot OFF

p=3: All dot ON

p=4: Repeat blink display with nomal and Reverse display (Nomal :2sec., Reverse:2sec.)

Function: Control Power ON or OFF, and Start Screen saver mode.

p=0~1 : Control Power ON or OFF. This is applied until this command is re-specified

p=2~4 : Start Screen saver mode. This command is canceled if next any data is inputted during screen saver mode, and return to the previous display condition before screen saver mode specified.

**7.1.28 US ( f n [parameter] (Bit image display group)**

Function: Execute processing of bit image data.

n: Specifies function code.

n	Function No.	Function
11H	Function 11H	Real-time bit image display

**7.1.29 <Function 11H> US ( f n xL xH yL yH g d(1)...d(k)**

**(Real-time bit image display)**

**Code: 1Fh 28h 66h 11h xL xH yL yH g d(1)...d(k)**

n: Classify command

xL: Bit image X size lower byte ( by 1dot)

xH: Bit image X size upper byte ( by 1dot)

yL: Bit image Y size lower byte ( by 8dots)

yH: Bit image Y size upper byte ( by 8dots)

g: Image =1(Fixed)

d(1) - d(k): Image data (Refer to figure as follows)

Definable area:  $n = 11H$   
 $1 \leq (xL + xH \times 256) \leq 512$   
 $1 \leq (yL + yH \times 256) \leq 2$   
 $g=1$   
 $0 \leq d \leq 255$   
 $k = x \ X \ y \ X \ g$

Function: Display the bit image data inputed on the cursor position real-time.  
 Cursor position will not change.

When bit image is display on cursor position, and if it overflows from the current window, it is displayed until edge of area defined, and remaining bit image overflowed is not displayed. If the Display position or image size e.t.c are defined to out of definable area, the command is ignored, and the data is valid as standard data.

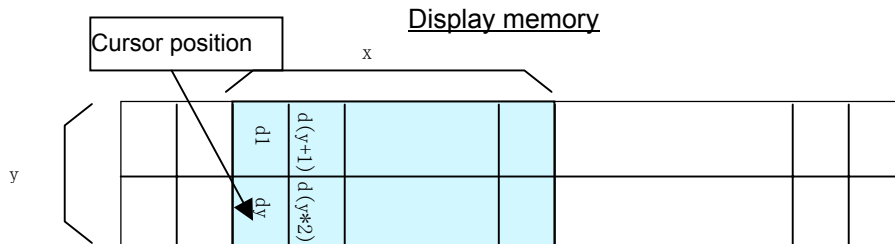

**7.1.30 US ( g n [parameter] (Font command group)**

Function: Execute processing of window command.

N	Function No.	Function
03H	Function 03H	Character display width
40H	Function 40H	Font magnified display

n: specify function code.

**7.1.31 <Function 03H> US ( g n w (Character display width)**

Code: 1FH 28H 67H 03H w

n: Classify command

w: Specify width

Definable area:  $n = 03H$

$0 \leq w \leq 3$

w = 0: Fixed character width 1 (1 dot space in right side)

w = 1: Fixed character width 2 (1 dot space in each right and left side)

w = 2: Proportional character width 1 (1 dot space in right side)

w = 3: Proportional character width 2 (1 dot space in each right and left side)

Default: w= 1

Function: Specifies character display width.

Fixed character width 1 & 2: Character is written with fixed character width. (6 or 7dot)

Proportional character width: Character is written with proportioned character width.

**7.1.32 <Function 40H> US ( g n x y ) (Font magnified display)**

**Code:** 1FH 28H 67H 40H x y

n: Classify command  
 x: Specify the size of magnification X  
 y: Specify the size of magnification Y

Definable area: n = 40H  
 $1 \leq x \leq 4$   
 $1 \leq y \leq 2$

Default: x = 1  
 Y = 1

Function: Specifies magnification of character.  
 Character is magnified including the space specified by Character display width command.

(x=1, y=1)

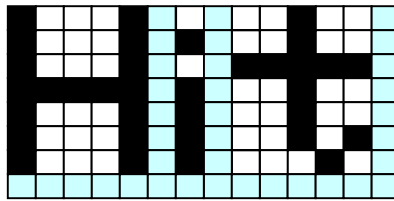

(x=2, y=2)

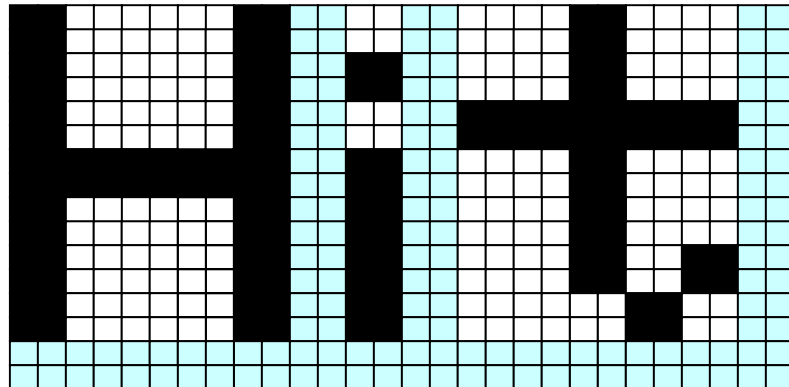

**7.1.33 US ( w n [parameter] ) (Window command group)**

Function : Execute processing of window / screen command.

n	Function No.	Function
01H	Function 01H	Current window select
02H	Function 02H	User -Window difinition and cancel
10H	Function 10H	Write screen mode select

n: specify function code.

**7.1.34 <Function 01H> US ( w n a (Current Window select)****Code: 1FH 28H 77H 01H a**

n: Classify command  
 a: Current window number  
 a = 0: Base-Window  
 a = 1 ~ 4: User-Window

Definable area: n = 01H  
 $0 \leq a \leq 4$

Function: Select current window

This command is ignored if current window number is specified for User-Window that is not defined.

**7.1.35 <Function 02H> US ( w n a b[xPL xPH yPL yPH xSL xSH ySL ySH]****(User Window definition-cancel)****Code: 1Fh 28h 77h n a b [xPL xPH yPL yPH xSL xSH ySL ySH]**

n: Classify command  
 a: Definable window No. No.1 ~ 4  
 b: Define or Cancel b=0 : Cancel, b=1: Define  
 xPL: Left position of window lower byte ( by 1dot)  
 xPH: Left position of window upper byte ( by 1dot)  
 yPL: Top position of window lower byte ( by 8dot)  
 yPH: Top position of window upper byte ( by 8dot)  
 xSL: X size of window lower byte ( by 1dot)  
 xSH: X size of window upper byte ( by 1dot)  
 ySL: Y size of window lower byte ( by 8dot)  
 ySH: Y size of window upper byte ( by 8dot)

Definable area: n = 02H  
 $1 \leq a \leq 4$   
 $0 \leq b \leq 1$   
 $0 \leq xP \leq 511$   
 $0 \leq yP \leq 1$   
 $1 \leq xS \leq 512$   
 $1 \leq yS \leq 2$

Function: Define or cancel User-Window

Display contents are remained even if this command is executed.

When User-Window is defined (b=1)

Specify Definable Window No., Window position and Window size, and Window position and Window size are specified by the block (Block/1x8dot)



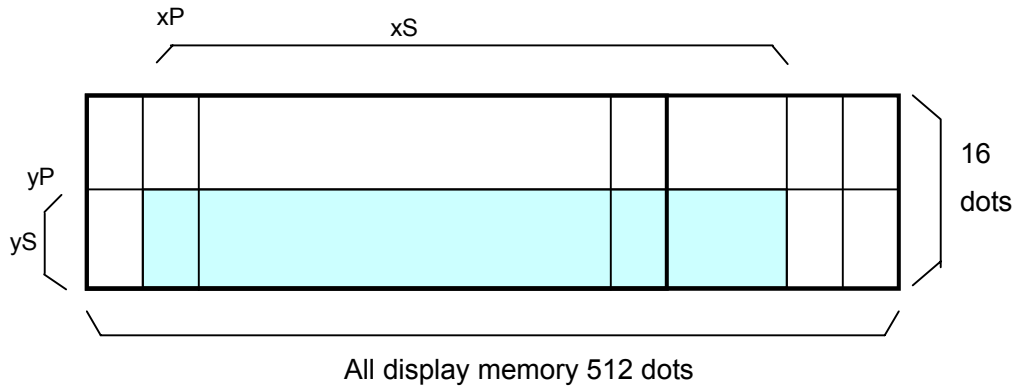

User-Window can be defined up to 4 windows.

The cursor position after excuted this command is specified to top left (X=0, Y=0).

When User-Window is canceled (b=0)

It is not necessary to specify window position [xPL~ySH] in case of cancel the User-Window .

The Base-Window is selected as current window in case of user window canceled was selected as current window.

**7.1.36 <Function 10H> US ( w n a (Write screen mode select (see sect. 6.3)**

Code:      **1FH 28H 77H n a**  
           n:      Classify command  
           a:      Write screen mode  
                   a = 0: Display acreen mode  
                   a = 1: All screen mode  
 Definable area:   n = 10H  
                           0 ≤ a ≤ 1

Default: a= 0

Function: Select the write screen mode. **This effects only for Base Window.**

Display action is valid within area of either Display ara or Hlidden area depending on cursor position.

Select "All screen mode": Display action is valid on all of screen area.

**7.1.37 WINx (Short-Cut Current Window Select)**

Function: Current window move to selected window.

Refer to 7.1.34 for more detail.

WINx	Function
WIN0 (10h)	Select the base window
WIN1 (11h)	Sleect the user window1
WIN2 (12h)	Select the user window2
WIN3 (03h)	Select the user window3
WIN4 (04h)	Select the user window4

**7.2 Bit image data format**

The Bit image consists of the data for image size (x \* y) as follows;

Data	Pattern position
d (1)	P1
d (2)	P2
d (x * y)	P(x * y)

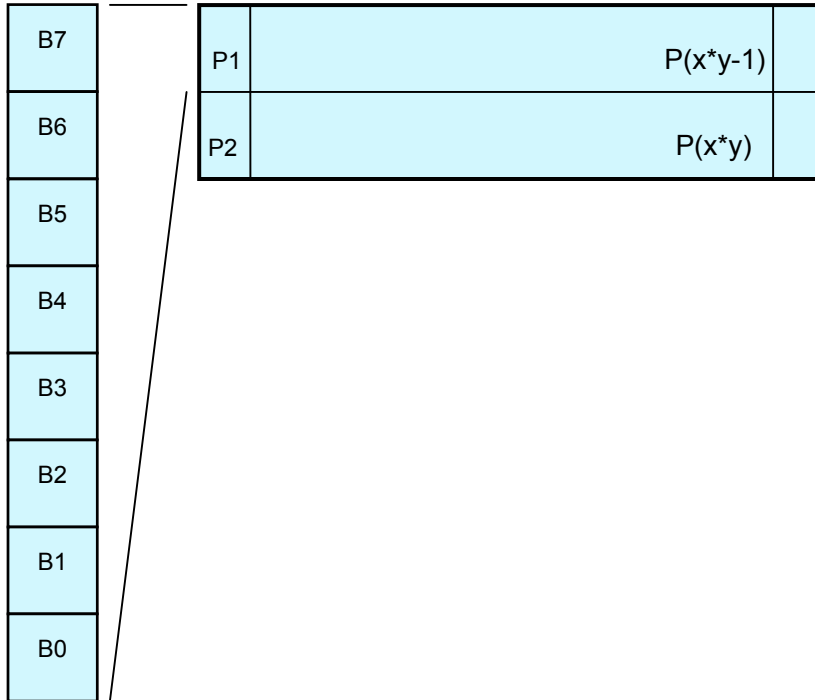

## 8 Setup

### 8.1 Jumper

No.	Function	Default
J0	Baud Rate select	OPEN
J1		OPEN
J2	Select serial I/F	OPEN
J3	Reserve	OPEN
JRB	Do not use.	OPEN

#### 8.1.1 Baud rate select (Applying for Asynchronous serial interface)

J0	J1	Baud rate
OPEN	OPEN	38,400bps
SHORT	OPEN	19,200bps
OPEN	SHORT	9,600bps
SHORT	SHORT	115,200bps

#### 8.1.2 Serial interface select

J2	Mode
OPEN	Asynchronous serial I/F
SHORT	Synchronous serial I/F

## 9 Connector

### 9.1 Serial interface connector (Six through holes)

#### 9.1.1 Case of Asynchronous serial interface is selected.

Pin No.	Signal name	Function	Direction
1	VCC	Power supply	Input
2	SIN	Data receive	Input
3	GND	Ground	Input
4	SBUSY	Display busy	Output
5	NC	Non connection	-
6	/RESET	Reset	Input

#### 9.1.2 Case of Synchronous serial interface is selected.

Pin No.	Signal name	Function	Direction
1	VCC	Power supply	Input
2	SIN	Data receive	Input
3	GND	Ground	Input
4	SBUSY	Display busy	Output
5	SCK	Display clock	Input
6	/RESET	Reset	Input

## 10 Notation of firmware version

The firmware version is written in the following position.

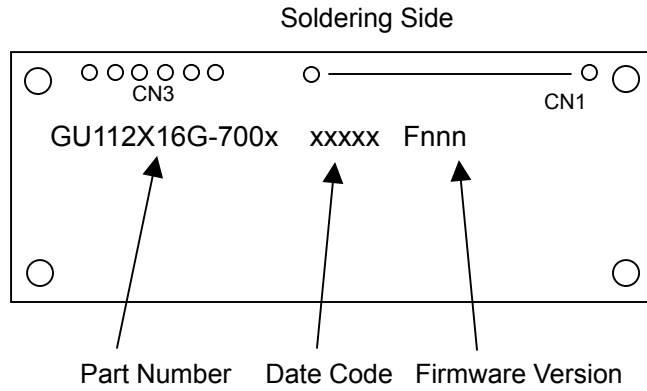

11 Outline Drawing

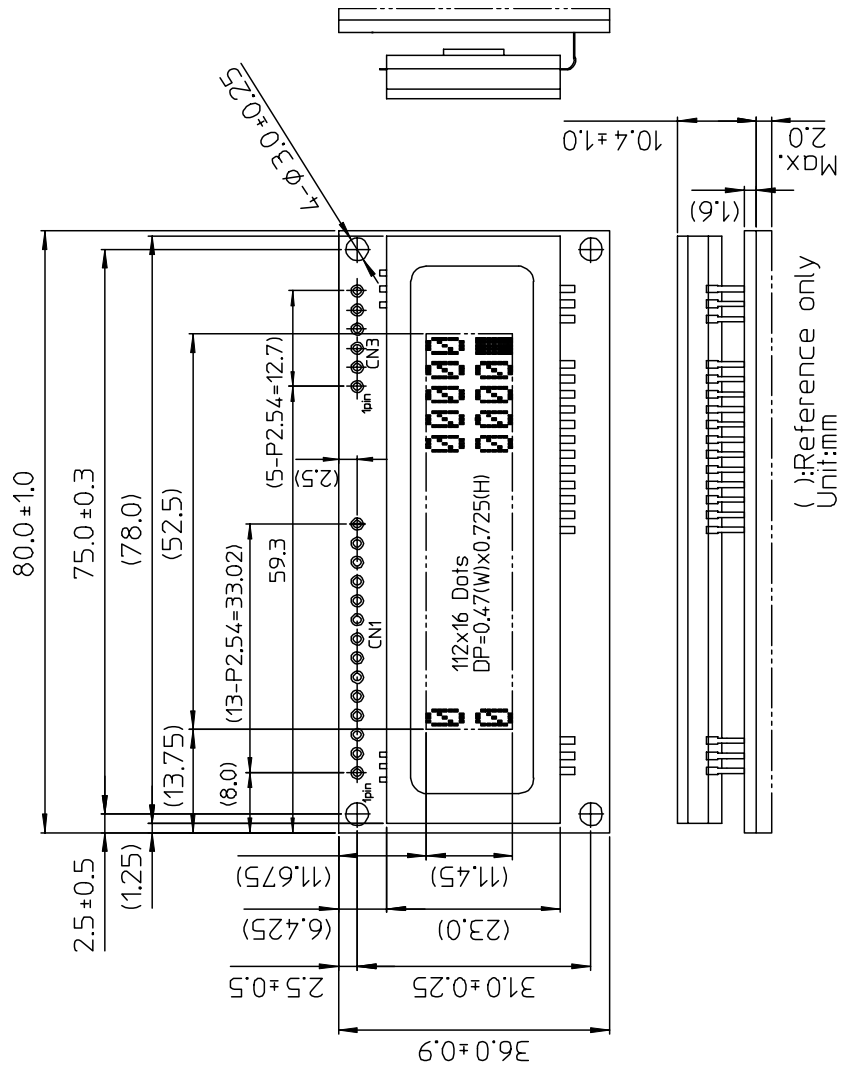

## Notice for the Cautious Handling VFD Modules

### Handling and Usage Precautions:

Please carefully follow the appropriate product application notes for proper usage, safety handling, and operation standards for maximum performance.

#### [VFD tubes are made of glass]

- Because the edges of the VFD glass-envelop are not smooth, it is necessary to handle carefully to avoid injuries to your hands
- Please avoid breaking the VFD glass-envelop to prevent injury from sharp glass particles.
- The tip of the exhaust pipe is fragile so avoid shock from impact.
- It is recommended to allow sufficient open space surrounding the exhaust pipe to avoid possible damage.
- Please design the PCB for the VFD-module within 0.3 mm warping tolerance to avoid any forces that may damage the display due to PCB distortion causing a breakdown of the electrical circuit leading to VFD failure.

#### [High voltage]

- Avoid touching conductive electrical parts, because the VFD-module uses high voltage exceeding 30~100 volts.
- Even when electric power is turned off, it may take more than one minute for the electrical current to discharge.

#### [Cable connection]

- Do not unplug the power and/or data cables of VFD-modules during operating condition because unrecoverable damage may result.
- Sending input signals to the VFD-module during a power off condition sometimes causes I/O port damage.
- It is recommended to use a 30 cm or shorter signal cable to prevent functional failures.

#### [Electrostatic charge]

- VFD-modules needs electrostatic free packaging and protection from electrostatic charges during handling and usage.

#### [Structure]

- During operation, VFD and VFD-modules generate heat. Please consider sufficient heat radiation dissipation using heat sink solutions.
- We prefer to use UL grade materials or components in conjunction with VFD-modules.
- Wrap and twist motion causes stress and may break VFDs & VFD modules. Please adhere to allowances within 0.3mm at the point of attachment.

#### [Power]

- Apply regulated power to the VFD-module within specified voltages to protect from failures.
- Because some VFD-modules may consume in rush current equal to twice the typical current at power-on timing, we recommend using a sufficient power capability and quick starting of the power regulator.
- VFD-module needs a specified voltage at the point of connection. Please use an adequate power cable to avoid a decrease in voltage. We also recommend inserting a power fuse for extra protection.

#### [Operating consideration]

- Illuminating phosphor will decrease in brightness during extended operation. If a fixed pattern illuminates for an extended period,( several hours), the phosphor efficiency will decrease compared to the non operating phosphor causing a non uniform brightness among pixels. Please consider programming the display patterns to use all phosphor segments evenly. Scrolling may be a consideration for a period of time to refresh the phosphor condition and improve even illumination to the pixels.
- We recommend using a signal cable 30cm or less to avoid some possible disturbances to the signal.

#### [Storage and operating environment]

- Please use VFD-modules under the recommended specified environmental conditions. Salty, sulfur and dusty environments may damage the VFD-module even during storage.

#### [Discard]

- Some VFDs contain a small amount of cadmium in the phosphor and lead in the solder. When discarding VFDs or VFD-modules, please adhere to governmental related laws or regulations.

#### [Others]

- Although the VFD-module is designed to be protected from electrical noise, please plan your circuitry to exclude as much noise as possible.
- Do not reconstruct or repair the VFD-module without our authorization. We cannot assure the quality or reliability of unauthorized reconstructed VFD-modules.

#### Notice:

- We do not authorize the use of any patents that may be inherent in these specifications.
- Neither whole nor partial copying of these specifications are permitted without our approval.  
If necessary , please ask for assistance from our sales consultant.
- This product is not designed for military, aerospace, medical or other life-critical applications. If you choose to use this product for these applications, please ask us for prior consultation or we cannot take responsibility for problems that may occur.

**Revision Note**

SPEC number	Date	Revision
DS-914-0001-04	June. 11,2004	Firmware version has been updated. Version No. : F100 1. Added Cursor ON/OFF command 2. Added Window select short-cut command