

Specification: **GU140X32F-7806AC**
 VFD Module

Features: **20x4 Character LCD Module Emulation**
 Extended Graphic Functions
 140x32 Dot Graphic Display
 Single 5V Supply
 High Brightness Blue Green Display
 Operating Temp -40°C to +85°C
 3 Font Sizes 5x5, 5x7, 10x14
 5x7 & 10x14 Cyrillic Fonts
 4/8 Bit Parallel LCD Interface
 SPI Synchronous Serial Interfaces
 Bi Directional Asynchronous Serial Interfaces

Reference: 10435
Issue Date: 16 August 2007
Revision: F2

Index		Page
1	General Description	3
	1.1 Scope	3
	1.2 Construction	3
	1.3 Outline	3
	1.4 Block Diagram	3
2	Electrical Specification	4
	2.1 Absolute Maximum Ratings	4
	2.2 Electrical Ratings	4
	2.3 Electrical Characteristics	4
3	Optical Specifications	5
4	Environmental Specifications	5
5	Interface	5
	5.1 Type of Interface	5
	5.2 Parallel Interface	5
	5.2.1 Basic Function	5
	5.2.2 Parallel Interface Timing	6
	5.3 Serial Interface	7
	5.3.1 Basic Function	7
	5.3.2 Asynchronous Serial Interface Timing	7
	5.3.3 Synchronous Serial Interface Timing	8
	5.3.4 Serial Control	8
	5.4 Reset	8
6	Software Functions	9
	6.1 Character Commands	9
	6.1.1 UDF Write	9
	6.1.2 Data Write	9
	6.1.3 Data Read	9
	6.1.4 Status / Cursor Position Read	9
	6.1.5 Display Clear	9
	6.1.6 Cursor Home	9
	6.1.7 Entry Mode	9
	6.1.8 Display Control	10
	6.1.9 Cursor Shift Left	10
	6.1.10 Cursor Shift Right	10
	6.1.11 Display Shift Left	10
	6.1.12 Display Shift Right	10
	6.1.13 Select 4 bit Interface	10
	6.1.14 Select 8 bit Interface	10
	6.1.15 Set CG Address	10
	6.1.16 Set DD Address	10
	6.2 Extended Graphic Commands	11
	6.2.1 Set Graphic Cursor	11
	6.2.2 Set Area	11
	6.2.3 Write Graphic Image	11
	6.2.4 Set Font	12
	6.2.5 Extended Graphic Command Example	13
	6.3 Extended Port and Serial Commands	13
	6.3.1 Port I/O Mode	13
	6.3.2 Synchronous Serial Mode	14
	6.3.3 Asynchronous Serial Mode	14
	6.3.4 Port Configure	14
	6.3.5 Read Port Status	15
	6.3.6 Port Out / Serial Send	15
	6.3.7 Port In / Serial Read	16
	6.3.8 Port Buffer Send	16
	6.3.9 Extended Port and Serial Command Examples	16

Index		Page
	6.4 Additional Serial Commands	18
	6.4.1 Set RS Low	18
	6.4.2 Data Read	18
	6.4.3 Read Cursor Position	18
7	Character Sets	19
	7.1 Mini 5x7 Font	19
	7.2 Standard 5x7 Font	19
	7.3 Cyrillic 5x7 Font	19
	7.4 Standard 10x14 Font	20
	7.5 Cyrillic 10x14 Font	20
8	Setup	21
	8.1 Jumper	21
	8.1.1 Serial / Parallel Selection	21
	8.1.2 Parallel Interface Type (M68 / i80)	21
	8.1.3 Asynchronous Serial Mode	21
	8.1.4 CN1 Pin 3 Function	21
9	Connector	22
	9.1 Parallel Interface Connector (Fourteen through holes)	22
	9.2 Serial Interface connector (Ten through holes)	22
	9.2.1 Asynchronous serial interface selected	22
	9.2.2 Synchronous serial interface selected	22
10	Notation of Firmware Version	23
11	Outline Drawing	24
	Notice for the Cautious Handling of VFD Modules	25

1.0 General Description

1.1 Scope

This specification covers the operating requirements of the vacuum fluorescent graphic display module GU140X32F-7806AC.

1.2 Construction

The module consists of a 140 x 32 dot graphic CIG-VFD, refresh RAM, character generator, DC/DC converter, display controller, and all necessary control logic. The module can simultaneously display graphic patterns and / or characters on the screen.

1.3 Outline

Power supply: + 5 V_{DC} only
 Interface: Parallel interface (CMOS)
 C-MOS Synchronous Serial Interface
 C-MOS Asynchronous Serial Interface
 Function: Character / Graphic display
 Control commands
 Character and Graphic Image Download
 Applied reliability spec: TT-99-3102
 Applied production spec: TT-98-3413

1.4 Block Diagram

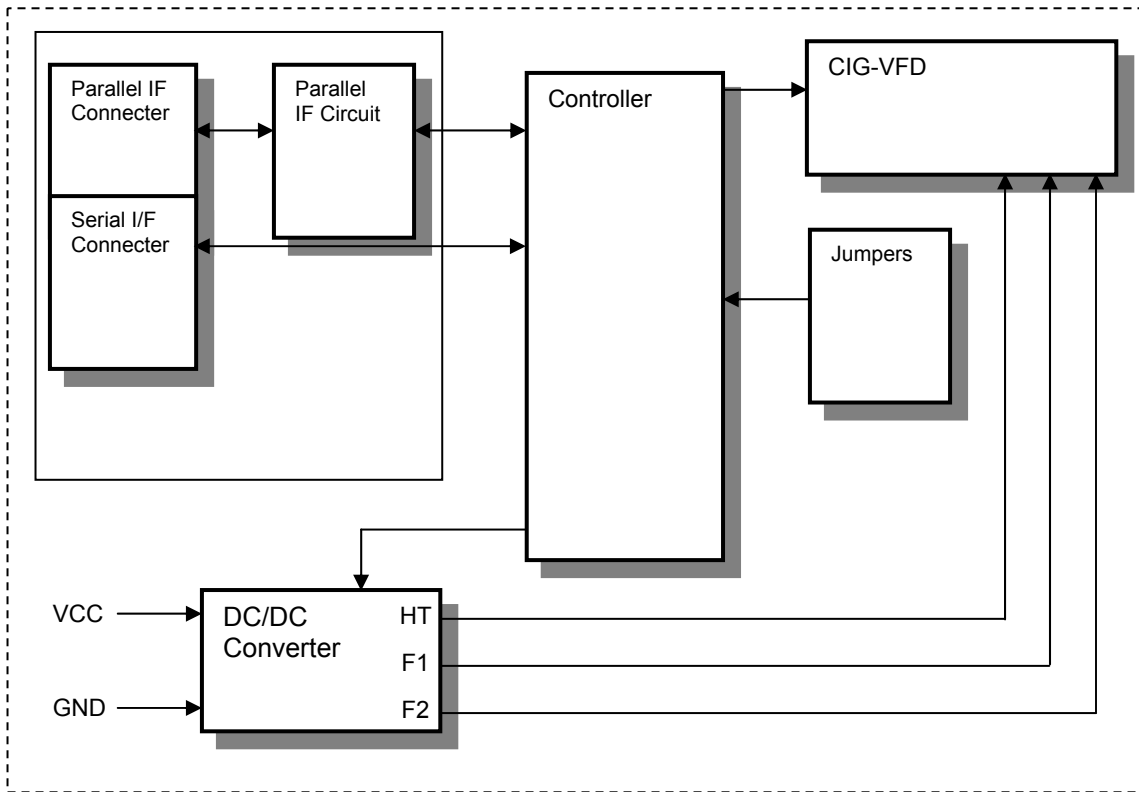

2.0 Electrical Specification

2.1 Absolute Maximum Ratings

Parameter	Symbol	Min.	Typ.	Max.	Unit	Condition	Note
Power Supply Voltage	VCC	-0.3	-	+6.0	VDC	GND=0V	
Logic Supply Voltage	VIN	-0.3	-	V _{cc} +0.3	VDC	GND=0V	D0-D7, E R/W, RS SIN, SCK /RESET

2.2 Electrical Ratings

Parameter	Symbol	Min.	Typ.	Max.	Unit	Condition	Note
Power Supply Voltage	VCC	4.75	5.0	5.25	VDC	GND=0V	

All driving voltages for the VFD are supplied by the DC/DC converter on board.

2.3 Electrical Characteristics

Measuring Conditions: Ambient temperature = 25° C, VCC =5.0VDC

Parameter	Symbol	Min.	Typ.	Max.	Unit	Condition	Note	
“L” Level Logic Input Current	IIL1	-	-	-0.15mA	mA	VIN=0V	D0-D7, R/W, RS, E	
	IIL2	-	-	-0.6	mA	VIN=0V	SIN,SCK, /RESET	
“H” Level Logic Input Current	IIN	-	-	1.0	uADC	VIN=5V	D0-D7, R/W, R S,	
Logic Input Voltage	“H”	VIH	0.8VCC	—	VCC	VDC	-	D0-D7, R/W, R S,
	“L”	VIL	0	—	0.6	VDC	-	
Logic Output Voltage	“H”	VOH	3.5	—	VCC	VDC	IOH=-10uA	D7(Busyflag) BUSY, D0-D7
	“L”	VOL	0	—	0.6	VDC	IOL=4mA	
Power Supply Current 1	ICC1	355	375	395	mADC		All dots ON	
Power Supply Current 2	ICC2	325	343	360	mADC		All dots OFF	
Power Supply Current 3	ICC3	-	35	45	mADC	-	Standby	

The power supply should be capable of supplying a higher current (x2) at ‘power on’ for 100ms

3.0 Optical Specifications

Number of dots:	140 x 32 (X x Y)
PCB Size:	98.0 mm x 60.0 mm (X x Y)
Display area:	69.85mm x 21.61mm(X x Y)
Dot size:	0.35mm x 0.53mm(X x Y)
Dot pitch:	0.5mm x 0.68mm (X x Y)
Luminance:	350cd/m ² Min. (700cd/m ² Typ.)
Color of illumination:	Green (Blue Green)

4.0 Environmental Specifications

Operating temperature:	-40 to +85degrees C
Storage temperature:	-40 to +85degrees C
Storage humidity:	20 to 80 % R.H(Non Condensing)
Vibration:	10-55-10Hz, all amplitude 1mm, 30Min., X-Y-Z (Non operating)
Shock:	392m/s ² (40G) 9mS X-Y-Z, 3times each direction (Non operating)

5.0 Interface

5.1 Type of Interface

The following CMOS interfaces are available on this module;
 Parallel M68 Interface (default) or i80 interface.
 Synchronous Serial Interface (SCK, SIN, SOUT, /SS, HB, MB, Reset)
 Asynchronous Serial Interface (RXD, TXD, HB, MB, Reset)

5.2 Parallel Interface

5.2.1 Basic function

The module sets the BUSY line upon receipt of data, and clears the line when ready to receive more data. BUSY is readable by Status read of D7 bit (see section 6.1.4) or BUSY signal directly. RS terminal is used for switching of data and command.

Operation	W/R	E	RS	D0-D7
Data Write	0	1 → 0	1	D0-D7:Data write
Data Read	1	1	1	D0-D7:Data read
Command Write	0	1 → 0	0	D0-D7:Command Write
Status Read	1	1	0	D0-D7: (D7 Busy) 1:BUSY, 0:READY D0-D6: Cursor Position

5.2.2 Parallel Interface timing

This module has a fast latching 8-bit data bus. The 'RS' and 'R/W' control lines should be set prior to the rising edge of the 'E' enable line. Data is clocked in on the falling edge of the enable line. The busy line should be checked before sending data.

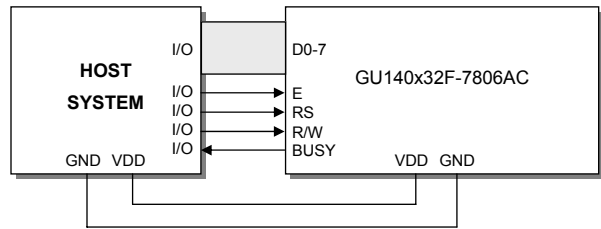

8-Bit Data/Command Write Timing Diagram.

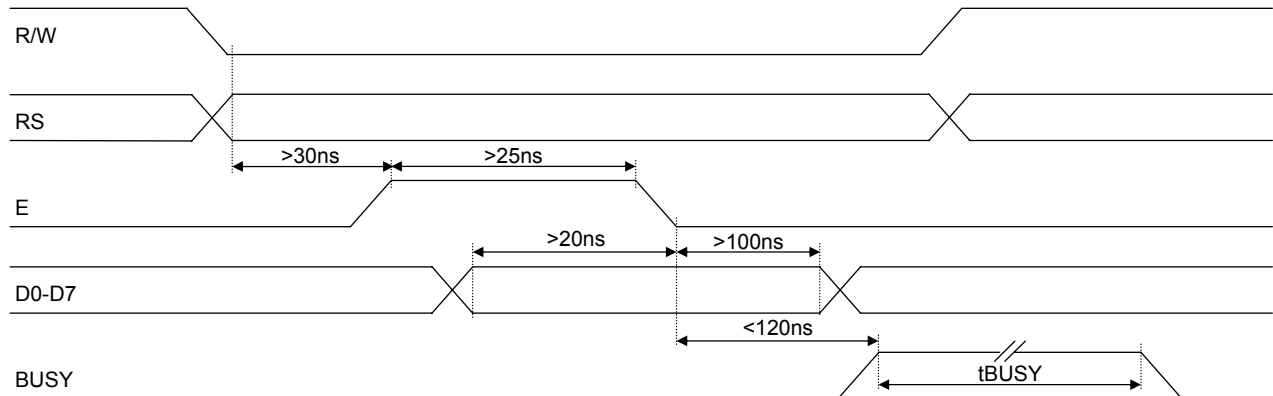

8-Bit Data/Status Read Timing Diagram.

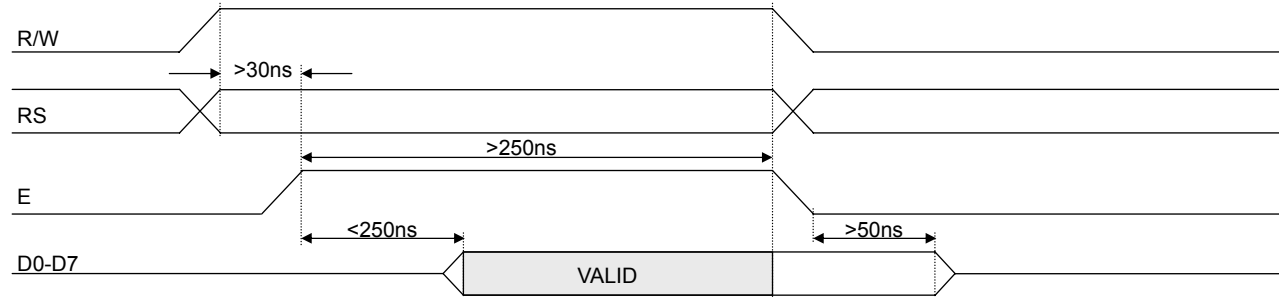

The busy state can be monitored on D7 when reading the DDRAM address (RS line low). The busy state can also be monitored directly from CN1 pin 3 if link J3 is set to 1&2.

The data bus width can be selected for 4-bit operation, using data lines D4-D7. Within this mode, two writes are required to send one data byte. The high nibble (bits 4-7) should be sent first, followed by the low nibble (bits 0-3). The busy state is not triggered between nibbles. It is important that the status is NOT read within 40us of sending the command to set either 4 or 8 bit mode.

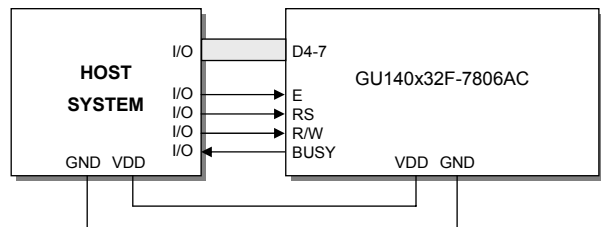

4-Bit Data/Command Write Timing Diagram.

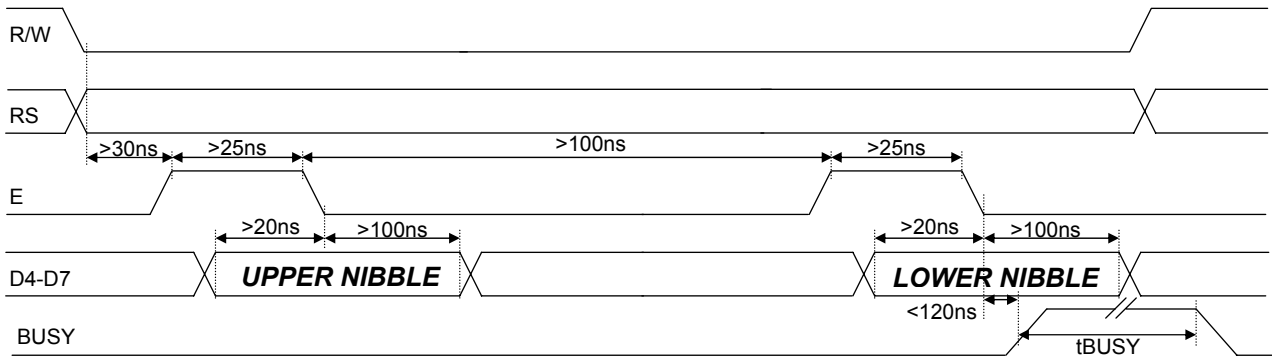

4-Bit Data/Status Read Timing Diagram.

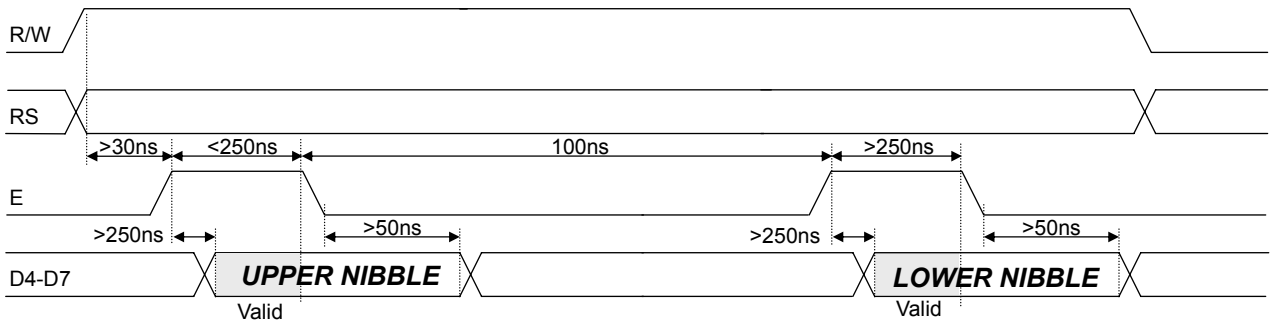

5.3 Serial Timing

5.3.1 Basic function

Asynchronous & synchronous serial interfaces are provided at TTL level. Synchronous is enabled with parallel, first received byte disables the other. To enable Asynchronous Serial Mode connect pin 4 and 6 on CN2 (LINK1 and LINK2), Link J6 and enable i80 Mode on J2 and J4. When using Asynchronous serial communications, the module is automatically initialized at power-up/reset with the cursor enabled.

5.3.2 Asynchronous serial interface timing

The host busy line (HB) stops the module from sending data to the host. The use of the HB and MB lines are optional, and can be connected together if not required.

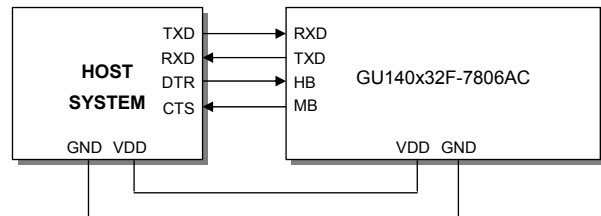

Host to Module Write

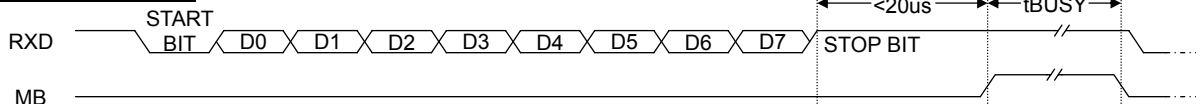

Module to Host Write

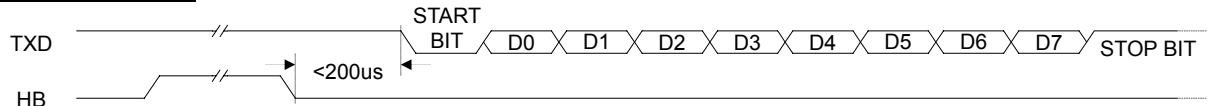

5.3.3 Synchronous serial interface timing

With synchronous communications enabled, data can be clocked into the VFD module on the rising edge of SCK, with the MSB sent first. The host must provide adequate delays for the module to process the data, these busy times are specified in the software command section. Alternatively the host can monitor the MB (Module Busy) line.

The /SS pin can be used as an enable pin if other devices are connected to the serial line, and also allows byte synchronization. The use of the /SS line is recommended, but can be permanently pulled low if not required.

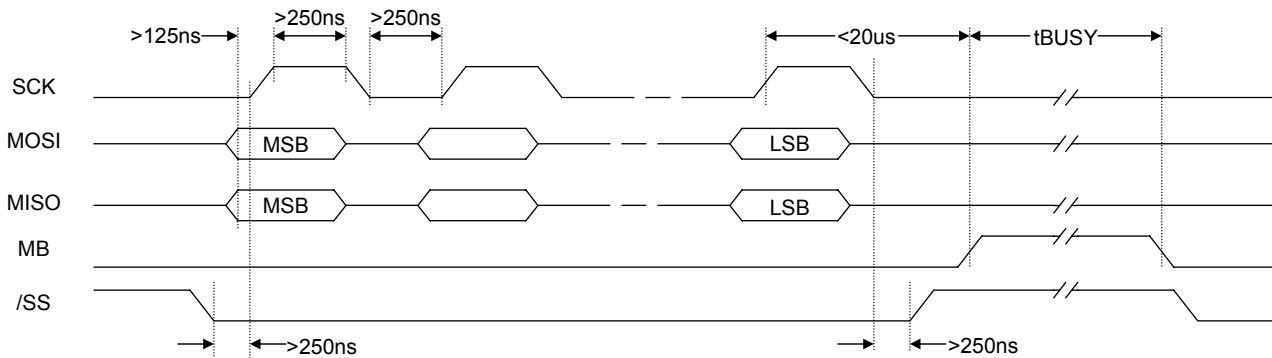
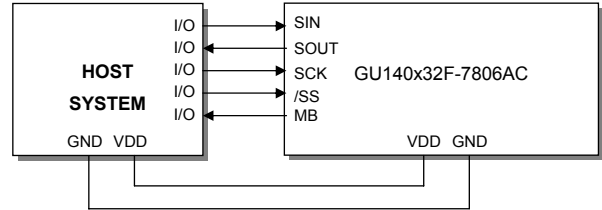

TTL Synchronous serial communication.

5.3.4 Serial control

An additional command has been included to distinguish between command and data writes when using serial communications. This command (0FH) will temporarily set the RS line low for the subsequent written byte. The following example displays two text messages using the serial communications and the 'Set RS' command: -

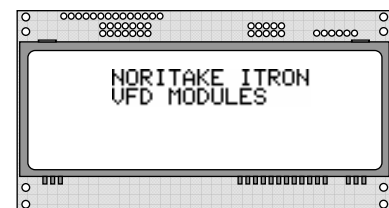
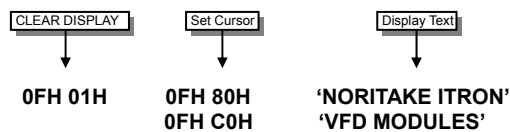

Displaying text using Serial Communications

5.4 Reset

At power ON the modules internal reset requires at least 8mS before commands can be sent. Please check the busy status. If you connect pin 3 to the hardware reset using jumper 3, the module will require 3mS to re-initialize. Reset is achieved by high-low-high transition of at least 100nS

6.0 Software Functions

This module features a command set that is LCD compatible, allowing easy replacement in existing equipment with little or no modifications. Careful consideration should be taken regarding the command execution times of this module. Although the commands can be executed within 40us, which is normal for LCD, busy times are increased when using the scroll write modes and with the cursor enabled. DD RAM address locations 70H+ are used to access the extended graphic commands.

At power up and reset the module is automatically initialized and ready to receive data. The interface is set to 8-bit, the display is cleared, the cursor position is set to the top-left corner (DD RAM address = 00H), and the display luminance is set to 100%.

6.1 Character Commands

6.1.1 UDF Write - Code: 00H – 0FH, RS = 1

Write user defined character 1-8 to the current cursor location on the display.

Codes 08H – 0FH & 00H – 07H display user defined characters 1-8

6.1.2 Data Write - Code: 10H – FFH, RS = 1 (40us – LCD compatible mode) (250us – Graphic mode)

Write data to the display. In normal (LCD compatible) mode of operation, data is written to the display data (DD RAM) or character generator (CG RAM).

When using the graphical data commands (F0H, F1H & F2H), data is written direct to the display and is not stored in DD RAM. Data write busy times will increase when using the graphic functions.

6.1.3 Data Read - Code: 00H – FFH, RS = 1, R/W = 1 (40us – LCD compatible mode)

Read data from the display. In normal (LCD compatible) mode of operation, data is read from the display data (DD RAM) or character generator (CG RAM).

6.1.4 Status / Cursor Position Read - Code: 00H – FFH, RS = 0, R/W = 1 (40us LCD compatible mode)

D0 – D6 of read data corresponds to the current cursor position. D7 shows the status of busy.

6.1.5 Display Clear - Code: 01H, RS = 0, Busy = 150us

Fills all locations in the display data (DD) RAM with 20H (blank character). The address counter is set to 0 in the DD RAM. The address counter is set to increment on each data read/write. Any display offset (using the display shift command) is removed.

6.1.6 Cursor Home - Code: 02H, RS = 0, Busy = 500us

The address counter is set to 0 in the DD RAM. Any display offset (using the display shift command) is removed.

6.1.7 Entry Mode - Code: 04H – 07H, RS = 0, Busy = 40us

Bit 1 is used to select the direction of the address counter on each data read or write. If set to '1', the address counter is incremented. If set to '0', the address counter is decremented.

Bit 0 enables the display to shift on each data read/write. If this bit is set to '1', the display is shifted with the cursor. The display shift direction depends upon the address counter direction (bit1). If this is set to increment, the display is shifted left, if the address counter is set to decrement, the display is shifted right.

Note: When display shift is enabled, the data write busy time can increase by 150us.

6.1.8 Display Control - Code: 08H – 0FH, RS = 0, Busy = 50us

Bit 2 is used to enable or disable the display. If this bit is set to '0' the VFD's power supply is turned off to reduce power consumption.

Bit 0 enables the flashing block cursor.

Note: If the cursor is enabled, busy times can increase by 20us

6.1.9 Cursor Shift Left - Code: 10H, RS = 0, Busy = 40us

Shift the cursor position (address counter) one position to the left.

6.1.10 Cursor Shift Right - Code: 14H, RS = 0, Busy = 40us

Shift the cursor position (address counter) one position to the right.

6.1.11 Display Shift Left - Code: 18H, RS = 0, Busy = 150us

Shift the display left, one character position.

6.1.12 Display Shift Right - Code: 1CH, RS = 0, Busy = 150us

Shift the display right, one character position.

6.1.13 Select 4 bit Interface - Code: 20H + lum, RS = 1, Busy = 40us

Enables 4-bit communications. Data is received on DB4-DB7 only. Two writes are required to send one data byte. The most significant nibble should be sent first. Refer to the 'Parallel Communications' section for more information. The *lum* value sets the displays brightness, and must be sent with the RS line high: -

00H = full brightness, 01H = 75%, 02H = 50% & 03H = 25%.

Do not read the status immediately after this command, a delay of 40us should be used instead.

6.1.14 Select 8 bit Interface - Code: 30H + lum, RS = 1, Busy = 40us

Enables 8-bit communications. Data is received on DB0-DB7. The *lum* value sets the displays brightness, and must be sent with the RS line high: -

00H = full brightness, 01H = 75%, 02H = 50% & 03H = 25%.

Do not read the status immediately after this command, a delay of 40us should be used instead.

6.1.15 Select CG Address - Code: 40H – 7FH, RS = 0, Busy = 40us

Set the character generator address (CG RAM). All written data is placed within the user definable character area.

6.1.16 Select DD Address - Code: 80H – E7H, RS = 0, Busy = 40us

Set the display data address (DD RAM). 80H – 93H = top line. C0H – D3H = 2nd line. 94H – A7H 3rd line, D4H – E7H 4th line.

6.2 Extended graphic commands

Command Structure and Values Copyright 2007 Noritake Co Limited, Japan

In addition to the standard LCD commands, this module includes additional commands to display graphical data, different font sizes, fill, clear and invert defined areas of the display. Also an outline command is available to draw rectangles around objects.

When any of these extended commands are executed, the module will change to the 'graphics' mode of operation. This graphics mode allows text to be written to any part of the display.

There are many differences the user should be aware of when the display is in this graphics mode: -

Written data may require additional busy times.

Text data is not written into the DD RAM and therefore can not be read back.

Graphical text can not be shifted onto the display.

The cursor is disabled & cursor direction is set to increment only.

UDF characters cannot be written.

All parameters and data (if applicable) should be written with RS line set high.

Note: After these commands are executed, the cursor will be disabled and any character data will be written to the display only, and not the DD RAM. Any subsequent LCD compatible command will re-enable the cursor and allow for DD RAM writing.

The graphics mode is disabled as soon as any valid LCD command is received.

6.2.1 Set Graphic Cursor - Code: F0H + *xpos* + *ypos*, RS = 0, Busy = 40us

Set the absolute cursor position. *xpos* = 0 – 139, *ypos* = 0 – 31.

6.2.2 Set Area - Code: F1H + *x1* + *y1* + *x2* + *y2* + *cmd*, RS = 0, Busy = 40us + 500us[cmd byte]

<i>x1</i> = left	<i>cmd</i> :- 'I' = invert area.
<i>y1</i> = top	'F' = fill area.
<i>x2</i> = right	'C' = clear area.
<i>y2</i> = bottom	'O' = set outline.
	'o' = clear outline.

6.2.3 Write graphic image - Code: F1H + *x1* + *y1* + *x2* + *y2* + *cmd*, RS = 0

<i>x1</i> = left	<i>cmd</i> :- 'H' = write horizontal graphical data with horizontal cursor movement.
<i>y1</i> = top	'V' = write vertical graphical data with horizontal cursor movement.
<i>x2</i> = right	'h' = write horizontal graphical data with vertical cursor movement.
<i>y2</i> = bottom	'v' = write vertical graphical data with vertical cursor movement.

Graphical data should immediately follow the 'H','h','V' and 'v' commands.

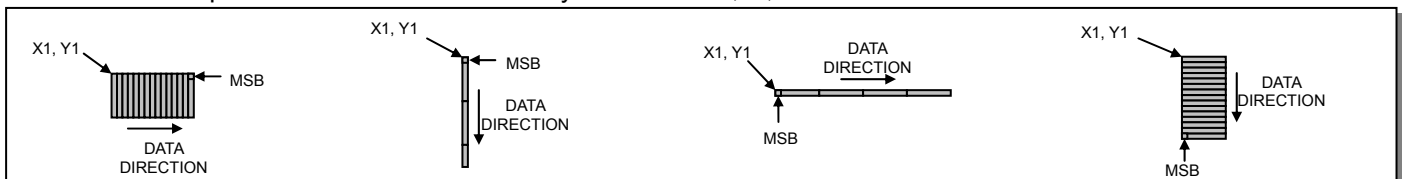

Vertical Data & Horizontal Movement

Vertical Data & Vertical Movement

Horizontal Data & Horizontal Movement

Horizontal Data & Vertical Movement

Graphical images can be displayed on the VFD module in either a horizontal or vertical byte orientation. After each graphical data write, the cursor is automatically advanced. All graphical data is contained within the defined area. Unused bits are masked where the screen area is not a byte multiple

The following example displays a simple graphical image. The graphical data orientation is set to horizontal data format, with a vertical cursor movement. Command bytes that are underlined should be sent with RS line low.

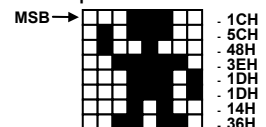

Graphic Image using horizontal data

GU140x32F-7806AC

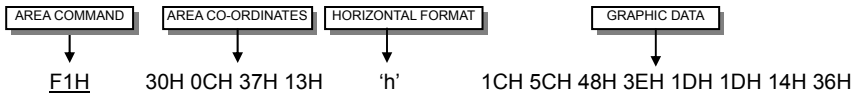

The next example displays a simple graphical image using a vertical data format, with a horizontal cursor movement. Command bytes that are underlined should be sent with RS line low.

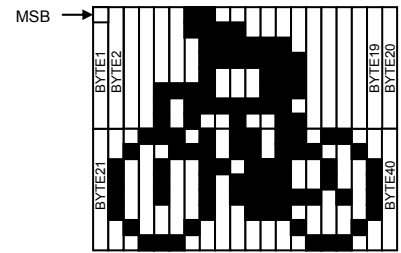

Graphic Image using vertical data

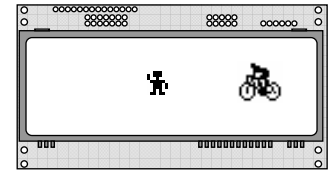
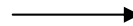
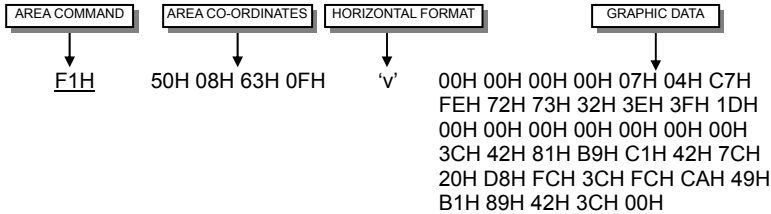

Displaying graphic images in Vertical and horizontal format.

6.2.4 Set Font - Code: F2H + font, RS = 0, Busy - 40uS

Select font type, font size and font spacing.

- Font:-
- 'A' or 'a' = proportional 64 character mini-font.
 - 'B' = 5x7 LCD compatible font with Katakana characters.
 - 'C' = 10x14 LCD compatible font with Katakana characters.
 - 'L' = LCD Font (default)*
 - 'I' = Cyrillic Font*
 - 'b' = 5x7 Cyrillic font with European characters.
 - 'c' = 10x14 Cyrillic font with European characters.
 - '1' = set the inter-character pixel spacing to 1 pixel.
 - '2' = set the inter-character pixel spacing to 2 pixels.

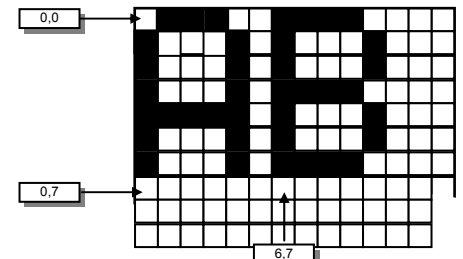

Cursor Positioning, example of writing 2 characters from cursor position 0,7.

The module contains 3 font sizes, a proportional 5x5 dot mini-font, 5x7 dot font, and a 10x14 dot font. Graphical text can be written to any part of the display using the 'Set Graphic Cursor' command (F0H). Characters are positioned above the current cursor position. Each character written will include either a one pixel or two pixel space to the right side of the character. After each character is written to the display, the cursor position is automatically advanced. If the cursor position reaches the end of the display, the host must reposition to the next line.

*These commands are used to change the font in LCD compatible mode.

The following example displays two text messages in the center of the display using the standard 5x7 character font. Command bytes that are underlined should be sent with RS line low.

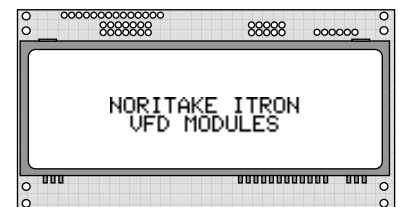
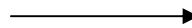
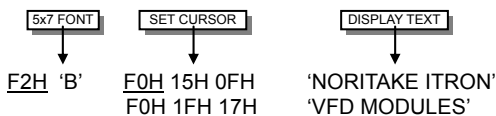

Displaying text using the 5x7 font.

The next example displays one line of text using the 10x14 character font. Command bytes that are underlined should be sent with RS line low.

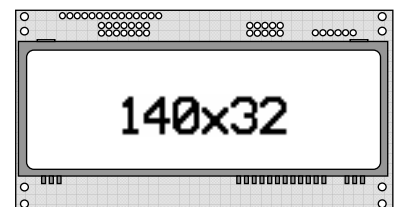
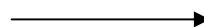
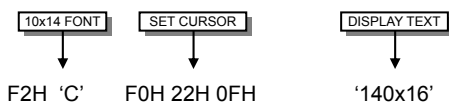

Displaying text in the large 10x14 font.

6.2.5 Extended Graphic Command Example

The following example displays three options for the user to select, each option is contained within a box with a shadow effect. Drawing horizontal and vertical lines using the fill area command creates the shadow effect. Command bytes that are underlined should be sent with RS line low.

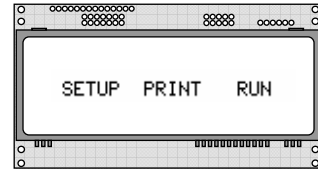
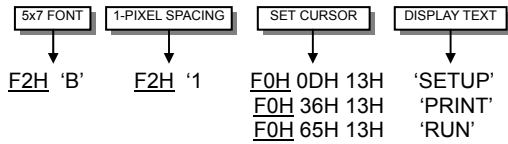

Display options with simple graphic text write.

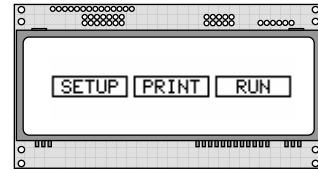
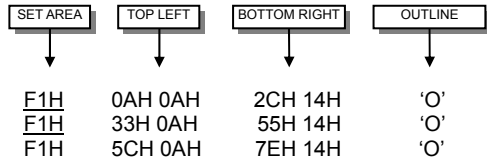

Boxes created using the 'Set Area Outline' command.

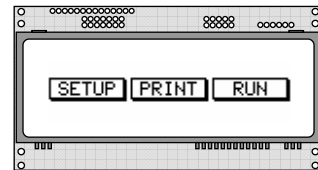
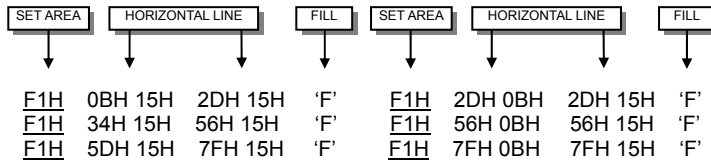

Drop Shadows created with the 'Fill Area' command.

The next example uses the invert area command to select one of the options.

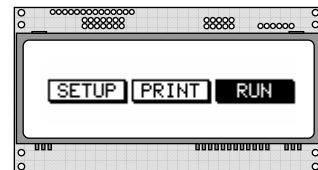
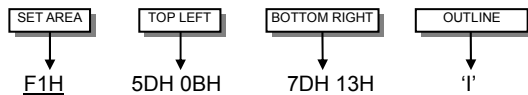

Option 'Run' selected with the 'Invert Area' command.

6.3 Extended Port and Serial Commands

Command Structure and Values Copyright 2007 Noritake Co Limited, Japan

The extended port and serial commands are only valid when the display is connected to the host using the parallel interface.

6.3.1 Port I/O Mode

The I/O mode gives direct access to the 7 control lines on the serial connector; HB, MB, TXD, RXD, MISO, MOSI and SCK. Each line can be individually set to an Input or Output using the 'PORT CONFIGURE' command. All inputs include an optional pull-up resistor, 30K-120K in value. The outputs can source ~5mA and sink ~30mA. There are 3 commands available to configure port, set port level and read port state.

6.3.2 Synchronous Serial Mode

This mode gives the ability to control external synchronous devices connected to the serial connector. Data is transmitted and received on each 'PORT OUT' command. The received data byte is buffered until the 'PORT READ' command is executed.

The 'PORT BUFFER SEND' command will buffer up to 128 bytes of data prior to transmission; only the last data byte received is captured when using this command.

The 'PORT CONFIGURE' command will set the MOSI & SCK lines to outputs, and the MISO line to an input. The HB line is used as an optional busy input, and the MB line is set to an output. The TXD line is also set to an output, and this can be used as a reset or device select control line.

The serial transmission is defined by the 'DEF H/L' (default clock level high or low), 'CLK EDGE' (rising or falling clock edge), and the 'SPEED' (clock speed) control bits. The 'HNDSHK' bit is used to detect the status of the HB line prior to data transmit. All data is transmitted MSB first.

A 'STATUS READ' command can be used to check for completed data transmission.

6.3.3 Asynchronous Serial Mode

This mode gives the ability to control external asynchronous devices connected to serial connector. Data is transmitted on each 'PORT OUT' command. Data received is held within a 1 byte buffer until the 'PORT READ' command is executed.

The 'PORT BUFFER SEND' command will buffer up to 128 bytes of data prior to transmission.

The 'PORT CONFIGURE' command will set the TXD & MB lines to outputs, and the RXD line to an input. The MISO line is also set to an output, and this can be used as a reset or device select control line. The HB line is used as an optional busy input. The MB line mirrors the RXC status flag, and indicates that data has been received.

A 'STATUS READ' command can be used to check for completed data transmission.

6.3.4 Port Configure - Code: F4H + byte, RS = 0

The operational mode is defined by bits in D7 and D6.

Port I/O Mode:

D7	D6	D5	D4	D3	D2	D1	D0
1	HB I/O	MB I/O	TXD I/O	MISO I/O	MOSI I/O	RXD I/O	SCK I/O

A '1' defines the port as an input a '0' defines the port as an output. All ports are subsequently set low.

Synchronous Serial Mode:

D7	D6	D5	D4	D3	D2	D1	D0
0	0	TXD OUT	HNDSHK	DEF H/L	CLK EDGE	SPEED1	SPEED0

The TXD port is set high with a '1' and low with a '0'. Busy detection is enabled by setting HNDSHK to a '1'. The default clock level is high with DEF H/L set to a '1', low if '0'. The CLK EDGE is set to rising with a '1', and falling with a '0'.

The clock speed is set with the SPEED D1/D0 bits:

- 00 = 4 MHz
- 01 = 1 MHz
- 10 = 250 kHz
- 11 = 125 kHz

Asynchronous Serial Mode:

D7	D6	D5	D4	D3	D2	D1	D0
0	1	MISO OUT	HNDSHK	PARITY1	PARITY0	BAUD1	BAUD0

The MISO port is set high with a '1' and low with a '0'. Busy detection is enabled by setting HNDSHK to a '1'.

The parity is set with the PARITY D1/D0 bits:

- 00 = none
- 10 = even
- 11 = odd

The baud rate is set with the BAUD D1/D0 bits:

- 00 = 4800
- 01 = 9600
- 10 = 19200
- 11 = 38400

6.3.5 Read Port Status - Code: F5H, RS = 0

Operational mode is dependant upon the byte sent with the 'Port Configure' command.

Synchronous Serial Mode:

D7	D6	D5	D4	D3	D2	D1	D0
-	-	-	HB IN	TX PEND	TXC	RXC	-

The current port status is read with RS high. TX PEND shows data is pending for transmission, TXC transmission completed, and RXC shows data received. HB IN shows the current state of the 'HB' line. TXC is cleared after status read.

Asynchronous Serial Mode:

D7	D6	D5	D4	D3	D2	D1	D0
-	-	-	HB IN	TX PEND	TXC	RXC	RXERR

The current port status is read with RS high. TX PEND shows that data is pending for transmission, TXC transmission was completed, and RXC shows data has been received. RX ERR indicates a received parity, overrun or framing error. HB IN shows the current state of the 'HB' line. The TXC bit is cleared after status read.

6.3.6 Port Out / Serial Send - Code: F6H + byte, RS = 0

Operational mode is dependant upon the byte sent with the 'Port Configure' command.

Port I/O Mode:

D7	D6	D5	D4	D3	D2	D1	D0
-	HB OUT	MB OUT	TXD OUT	MISO OUT	MOSI OUT	RXD OUT	SCK OUT

A '1' sets the corresponding port high, and a '0' sets it low. If the port is set to an input, a '1' will enable the internal pull-up resistor.

Synchronous Mode:

Data is transmitted to the synchronous serial port. If the 'HNDSHK' bit is enabled, transmission will be delayed until the HB line is pulled low.

Asynchronous Mode:

Data is transmitted to the asynchronous serial port. If the 'HNDSHK' bit is enabled, transmission will be delayed until the HB line is pulled low.

6.3.7 Port In / Serial read - Code: F7H, RS = 0

Operational mode is dependant upon the byte sent with the 'Port Configure' command.

Port I/O Mode:

D7	D6	D5	D4	D3	D2	D1	D0
-	HB IN	MB IN	TXD IN	MISO IN	MOSI IN	RXD IN	SCK IN

The current port levels are read with RS high.

Synchronous Mode:

The currently buffered data byte can be read with RS high. The host should first check the RXC bit using the PORT STATUS command. After reading the data byte, the RXC bit is cleared.

Asynchronous Mode:

The currently buffered data byte can be read with RS high. The host should first check the RXC bit using the PORT STATUS command. After reading the data byte, the RXC bit is cleared.

6.3.8 Port Buffer Send - Code: F8H + size + data, RS = 0

Operational mode is dependant upon the byte sent with the 'Port Configure' command.

Synchronous Mode:

A maximum of 128-bytes of data is buffered before transmission to the synchronous serial port. If the 'HNDSHK' bit is enabled, transmission is delayed until HB line is low.

Asynchronous Mode:

A maximum of 128-bytes of data is buffered before transmission to the asynchronous serial port. If the 'HNDSHK' bit is enabled, transmission is delayed until HB line is low.

6.3.9 Extended Port and Serial Command Examples

Port I/O Mode:

The following example demonstrates the use of the port output command to power two LED's and the port input command to read a switch status. Command bytes that are underlined should be sent with RS line low:-

Set RXD to input and other ports to outputs.

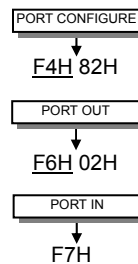

Turn on LED 1 and 2 by setting HB and MB low. Enable internal pull-up resistor on RXD.

Read port, D1 is the switch state.

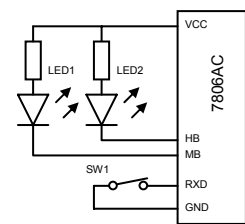

Synchronous Mode:

The following example demonstrates the use of the synchronous serial commands to communicate with another module. Command bytes that are underlined should be sent with RS line low:-

Enable synchronous mode with busy test, set clock speed to 125 kHz, data clocked on falling edge, default lock level is low.

Send byte 55H to synchronous port when HB line is low.

Read current status, wait until TXC is set.

Read current status, check if RXC is set.

Read received byte.

Send character string when HB is low.

Read current status, wait until TXC is set.

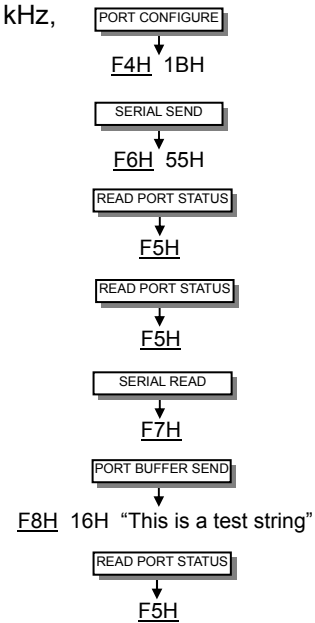

Asynchronous Mode:

The following example demonstrates the use of the asynchronous serial commands to communicate with another module. Command bytes that are underlined should be sent with RS line low:-

Enable asynchronous mode with busy test, set interface to 19200E.

Send byte 55H to asynchronous port when HB line is low.

Read current status. Wait until TXC is set.

Send byte AAH to asynchronous port when HB line is low.

Send character string when HB line is low.

Read current status and wait until TXC is set.

The next example will demonstrate a data read:-

Read port status.

Repeat until RXC is set then read the received byte.

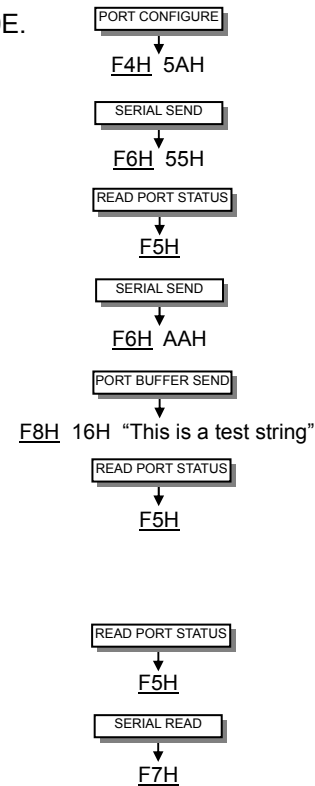

6.4 Additional Serial Commands

The following commands can only be used in serial communication mode.

6.4.1 Set RS Low - Code: 0FH

Set the RS line low for the following byte only.

6.4.2 Data Read - Code: FEH

Read data at current cursor position.

6.4.3 Read Cursor Position - Code: FFH

Read current cursor position.

7.0 Character Sets

7.1 Mini 5x5 Font

	00	01	02	03	04	05	06	07	08	09	0A	0B	0C	0D	0E	0F
20		!	l	h	b	z	s	9	()	*	+	,	-	.	/
30	0	1	2	3	4	5	6	7	8	9	:	;	<	=	>	?
40	a	b	c	d	e	f	g	h	i	j	k	l	m	n	o	
50	p	q	r	s	t	u	v	w	x	y	z	[]	^	_	

7.2 Standard 5x7 Font

	00	01	02	03	04	05	06	07	08	09	0A	0B	0C	0D	0E	0F
00																
10										!	"	#	\$	%	&	'
20		!	"	#	\$	%	&	'	()	*	+	,	-	.	/
30	0	1	2	3	4	5	6	7	8	9	:	;	<	=	>	?
40	a	b	c	d	e	f	g	h	i	j	k	l	m	n	o	
50	p	q	r	s	t	u	v	w	x	y	z	[]	^	_	
60	`	a	b	c	d	e	f	g	h	i	j	k	l	m	n	o
70	p	q	r	s	t	u	v	w	x	y	z	<		>	+	=
80	ä	å	ä	å	ä	å	ä	å	ä	å	ä	å	ä	å	ä	å
90	æ	ø	æ	ø	æ	ø	æ	ø	æ	ø	æ	ø	æ	ø	æ	ø
A0	•	「	」	、	・	ヲ	フ	イ	ウ	エ	オ	カ	キ	ク	ケ	コ
B0	ー	フ	イ	ウ	エ	オ	カ	キ	ク	ケ	コ	サ	シ	ス	セ	ソ
C0	タ	チ	ツ	テ	ト	ナ	ニ	ノ	ハ	ヒ	フ	ヘ	ホ	マ	ミ	ム
D0	メ	ム	ヤ	ユ	ヨ	ラ	リ	ル	レ	ロ	ワ	ヰ	ヱ	ヰ	ヱ	ヰ
E0	α	β	ε	ε	μ	ρ	ρ	ρ	ρ	ρ	ρ	ρ	ρ	ρ	ρ	ρ
F0	ρ	q	θ	ω	σ	ϖ	ϖ	ϖ	ϖ	ϖ	ϖ	ϖ	ϖ	ϖ	ϖ	ϖ

NOTE: UDF characters are available using 5x7 font only.

7.3 Cyrillic 5x7 Font

	00	01	02	03	04	05	06	07	08	09	0A	0B	0C	0D	0E	0F
00																
10										!	"	#	\$	%	&	'
20		!	"	#	\$	%	&	'	()	*	+	,	-	.	/
30	0	1	2	3	4	5	6	7	8	9	:	;	<	=	>	?
40	a	b	c	d	e	f	g	h	i	j	k	l	m	n	o	
50	p	q	r	s	t	u	v	w	x	y	z	[]	^	_	
60	`	a	b	c	d	e	f	g	h	i	j	k	l	m	n	o
70	p	q	r	s	t	u	v	w	x	y	z	<		>	+	=
80	ѐ	б	р	ѐ	и	і	і	і	і	і	і	і	і	і	і	і
90	ѐ	ѐ	ѐ	ѐ	ѐ	ѐ	ѐ	ѐ	ѐ	ѐ	ѐ	ѐ	ѐ	ѐ	ѐ	ѐ
A0	ѐ	ѐ	ѐ	ѐ	ѐ	ѐ	ѐ	ѐ	ѐ	ѐ	ѐ	ѐ	ѐ	ѐ	ѐ	ѐ
B0	ѐ	ѐ	ѐ	ѐ	ѐ	ѐ	ѐ	ѐ	ѐ	ѐ	ѐ	ѐ	ѐ	ѐ	ѐ	ѐ
C0	а	б	в	г	д	е	ж	з	и	й	к	л	м	н	о	п
D0	р	с	т	у	ф	х	ц	ч	ш	щ	ъ	ы	ь	э	ю	я
E0	а	б	в	г	д	е	ж	з	и	й	к	л	м	н	о	п
F0	р	с	т	у	ф	х	ц	ч	ш	щ	ъ	ы	ь	э	ю	я

7.4 Standard 10x14 Font

	00	01	02	03	04	05	06	07	08	09	0A	0B	0C	0D	0E	0F
00																
10										°	¢	ƒ	▼	▶	◀	▲
20		!	"	#	\$	%	&	'	()	*	+	,	-	.	/
30	0	1	2	3	4	5	6	7	8	9	:	;	<	=	>	?
40	0	A	B	C	D	E	F	G	H	I	J	K	L	M	N	O
50	P	Q	R	S	T	U	V	W	X	Y	Z	[¥]	^	_
60	`	a	b	c	d	e	f	g	h	i	j	k	l	m	n	o
70	p	q	r	s	t	u	v	w	x	y	z	()	→	←
80	Ä	Å	Á	À	á	à	Ä	Ö	ö	Ø	ø	Ü	ü	\	≠	~
90	Æ	æ	£	℞	◉	◊	◊	!	¢	£	¤	¥	€	⊥	↑	↓
A0	□	▣	▤	▥	▦	▧	▨	▩	▪	▫	▬	▭	▮	▯	▰	▱
B0	—	ア	イ	ウ	エ	オ	カ	キ	ク	ケ	コ	サ	シ	ス	セ	ソ
C0	タ	チ	ツ	テ	ト	ナ	ニ	ヌ	ネ	ノ	ヒ	フ	ハ	ホ	マ	メ
D0	ミ	ム	ヤ	ユ	ヨ	ヰ	ヱ	ヰ	ヱ	ヰ	ヱ	ヰ	ヱ	ヰ	ヱ	ヰ
E0	α	ä	β	ε	μ	σ	ρ	g	γ	"	j	*	φ	£	ñ	ö
F0	0	0	0	0	0	0	0	0	0	0	0	0	0	0	0	0

7.5 Cyrillic 10x14 Font

	00	01	02	03	04	05	06	07	08	09	0A	0B	0C	0D	0E	0F
00																
10										°	¢	ƒ	▼	▶	◀	▲
20		!	"	#	\$	%	&	'	()	*	+	,	-	.	/
30	0	1	2	3	4	5	6	7	8	9	:	;	<	=	>	?
40	0	A	B	C	D	E	F	G	H	I	J	K	L	M	N	O
50	P	Q	R	S	T	U	V	W	X	Y	Z	[¥]	^	_
60	`	a	b	c	d	e	f	g	h	i	j	k	l	m	n	o
70	p	q	r	s	t	u	v	w	x	y	z	()	→	←
80	Ё	ё	Г	г	Е	е	И	и	Ј	ј	Љ	љ	Њ	њ	У	у
90	Њ	ё	Г	г	Е	е	И	и	Ј	ј	Љ	љ	Њ	њ	У	у
A0	А	а	С	с	Д	д	Е	е	И	и	О	о	Р	р	Т	т
B0	а	а	с	с	д	д	е	е	и	и	о	о	р	р	т	т
C0	А	Б	В	Г	Д	Е	Ж	З	И	Й	К	Л	М	Н	О	П
D0	Р	С	Т	У	Ф	Х	Ц	Ч	Ш	Щ	Ъ	Ы	Ь	Э	Ю	Я
E0	а	б	в	г	д	е	ж	з	и	й	к	л	м	н	о	п
F0	р	с	т	у	ф	х	ц	ч	ш	щ	ъ	ы	ь	э	ю	я

8.0 Setup

8.1 Jumper

No.	Function	Default
J3	CN1 Pin 3 Function	OPEN
J2	Parallel Interface Type	2-3
J6	Serial/Parallel Selection	OPEN
J4	Parallel Interface Type	2-3
J12	Serial Selection	OPEN

8.1.1 Serial / Parallel Selection

J6	Interface
Open	Sync Serial / Parallel (default)
Link	Asynchronous Serial

Synchronous enabled with parallel. The first received byte disables the other.

8.1.2 Parallel Interface Type (M68 / i80)

J2	J4	Mode	Signals
1-2	1-2	i80	Pin 5 = /WR, Pin 6 = /RD
2-3	2-3	M68	Pin 5 = R/W, Pin 6 = E

8.1.3 Asynchronous. Serial Mode*

J12			Configuration
1-2	3-4	7-8	
O	O	O	9600,N,8,1
L	O	O	19200,N,8,1
O	L	O	38400,N,8,1
X	X	L	Self Test Mode

All J12 links & J6 should be open for parallel operation.

* To enable Asynchronous Serial Mode connect pin 4 and 6 on CN2 (LINK1 and LINK2), Link J6 and enable i80 Mode on J2 and J4.

8.1.4 CN1 Pin 3 Function

J3	Function
2 & 3	/Reset
1 & 2	Busy

9.0 Connector

9.1 Parallel interface connector (Fourteen through holes) – CN1 / CN5

Pin No.	Signal name	Function	Direction
1	GND	Ground	Input
2	VCC	Power supply	Input
3	NC *	Non connection	-
4	RS	Switch signal	Input
5	R/W	Read /write select	Input
6	E	Enable	Input
7	D0	Data input	Input/output
8	D1	Data input	Input/output
9	D2	Data input	Input/output
10	D3	Data input	Input/output
11	D4	Data input	Input/output
12	D5	Data input	Input/output
13	D6	Data input	Input/output
14	D7(PBUSY)	Data input	Input/output

* Pin3 can be changed to /RESET or BUSY terminal, and selectable by jumper J3 (2-3) or J3 (1-2)

9.2 Serial interface connector (Ten through holes) – CN2

9.2.1 Asynchronous Serial interface selected

Pin No.	Signal name	Function	Direction
1	VCC	Power supply	Input
2	NC	Not Connected	
3	RXD	Receive	Input
4	LINK1		Link
5	GND	Ground	Input
6	LINK2		Link
7	TXD	Transmit	Output
8	/RES	Reset	Input
9	MB	Module Busy	Output
10	HB	Host Busy	Input

9.2.2 Synchronous Serial interface selected

Pin No.	Signal name	Function	Direction
1	VCC	Power supply	Input
2	SCK	Display clock	Input
3	/SS	SPI Select	Input
4	SIN	Data receive	Input
5	GND	Ground	Input
6	SOUT	Data Transmit	Output
7	NC	Not Connected	
8	/RESET	Reset	Input
9	MB	Module Busy	Output
10	HB	Host Busy	Input

10.0 Notation of firmware version

The firmware version is written in the following position.
Non Glass Side

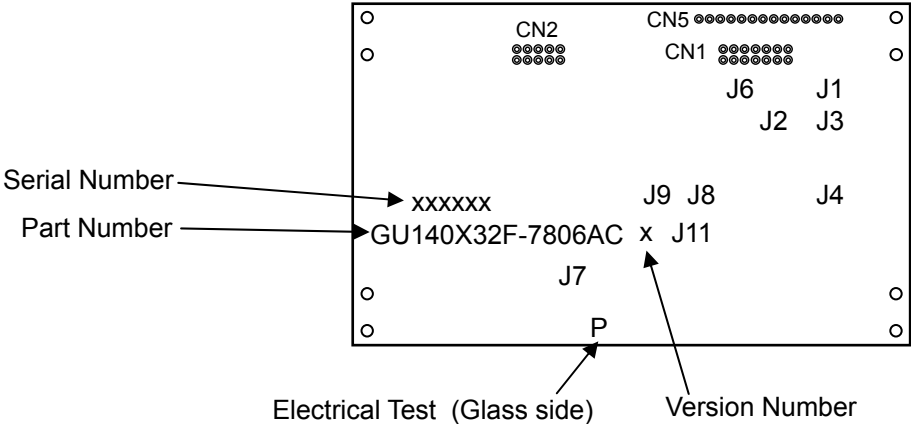

11.0 Outline Drawing

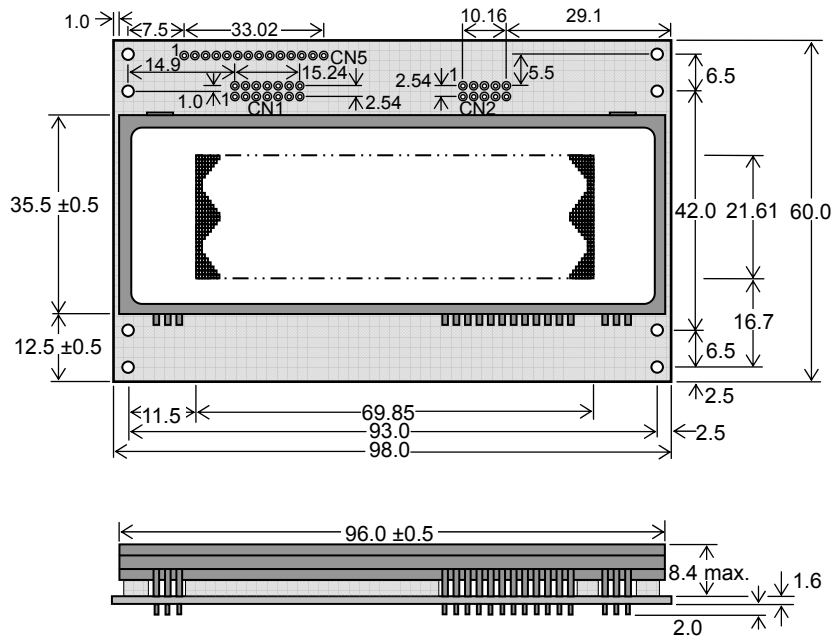

Dimensions in mm & subject to tolerances.

Mounting holes 3.2mm dia.

Notice for the Cautious Handling of VFD Modules

Handling and Usage Precautions:

Please carefully follow the appropriate product application notes for proper usage, safety handling, and operation standards for maximum performance.

[VFD tubes are made of glass]

- Because the edges of the VFD glass-envelop are not smooth, it is necessary to handle carefully to avoid injuries to your hands
- Please avoid breaking the VFD glass-envelop to prevent injury from sharp glass particles.
- The tip of the exhaust pipe is fragile so avoid shock from impact.
- It is recommended to allow sufficient open space surrounding the exhaust pipe to avoid possible damage.
- Please design the PCB for the VFD-module within 0.3 mm warping tolerance to avoid any forces that may damage the display due to PCB distortion causing a breakdown of the electrical circuit leading to VFD failure.

[High voltage]

- Avoid touching conductive electrical parts, because the VFD-module uses high voltage exceeding 30V-100 volts.
- Even when electric power is turned off, it may take more than one minute for the electrical current to discharge.

[Cable connection]

- Do not unplug the power and/or data cables of VFD-modules during operating condition because unrecoverable damage may result.
- Sending input signals to the VFD-module during a power off condition sometimes causes I/O port damage.
- It is recommended to use a 30 cm or shorter signal cable to prevent functional failures.

[Electrostatic charge]

- VFD-modules needs electrostatic free packaging and protection from electrostatic charges during handling and usage.

[Structure]

- During operation, VFD and VFD-modules generate heat. Please consider sufficient heat radiation dissipation using heat sink solutions.
- We prefer to use UL grade materials or components in conjunction with VFD-modules.
- Wrap and twist motion causes stress and may break VFDs & VFD modules. Please adhere to allowances within 0.3mm at the point of attachment.

[Power]

- Apply regulated power to the VFD-module within specified voltages to protect from failures.
- Because some VFD-modules may consume in rush current equal to twice the typical current at power-on timing, we recommend using a sufficient power capability and quick starting of the power regulator.
- VFD-module needs a specified voltage at the point of connection. Please use an adequate power cable to avoid a decrease in voltage. We also recommend inserting a power fuse for extra protection.

[Operating consideration]

- Illuminating phosphor will decrease in brightness during extended operation. If a fixed pattern illuminates for an extended period,(several hours), the phosphor efficiency will decrease compared to the non operating phosphor causing a non uniform brightness among pixels. Please consider programming the display patterns to use all phosphor segments evenly. Scrolling may be a consideration for a period of time to refresh the phosphor condition and improve even illumination to the pixels.
- We recommend using a signal cable 30cm or less to avoid some possible disturbances to the signal.

[Storage and operating environment]

- Please use VFD-modules under the recommended specified environmental conditions. Salty, sulfur and dusty environments may damage the VFD-module even during storage.

[Discard]

- Some VFDs contain a small amount of cadmium in the phosphor and lead in the solder. When discarding VFDs or VFD-modules, please adhere to governmental related laws or regulations.

[Others]

- Although the VFD-module is designed to be protected from electrical noise, please plan your circuitry to exclude as much noise as possible.
- Do not reconstruct or repair the VFD-module without our authorization. We cannot assure the quality or reliability of unauthorized reconstructed VFD-modules.

Notice:

We do not authorize the use of any patents that may be inherent in these specifications.

Neither whole nor partial copying of these specifications are permitted without our approval.

If necessary , please ask for assistance from our sales consultant.

This product is not designed for military, aerospace, medical or other life-critical applications. If you choose to use this product for these applications, please ask us for prior consultation or we cannot take responsibility for problems that may occur.