

Dot Graphic VFD Module

GU140x16G-7820A

- ❑ 140x16 Dot Graphic (2x20 characters)
- ❑ Single 5V Supply
- ❑ High Brightness Blue Green Display
- ❑ Operating Temp -40°C to +85°C
- ❑ 3 Multi Sized Fonts including Cyrillic
- ❑ 4/8 Bit Parallel LCD & Serial Interfaces

The module includes the Vacuum Fluorescent Display glass, VF drivers and micro-controller ICs with refresh RAM, character generator and interface logic. The 4/8 bit parallel & serial bi-directional interfaces are 5V TTL/CMOS compatible. The command set is LCD compatible with extended graphic functions.

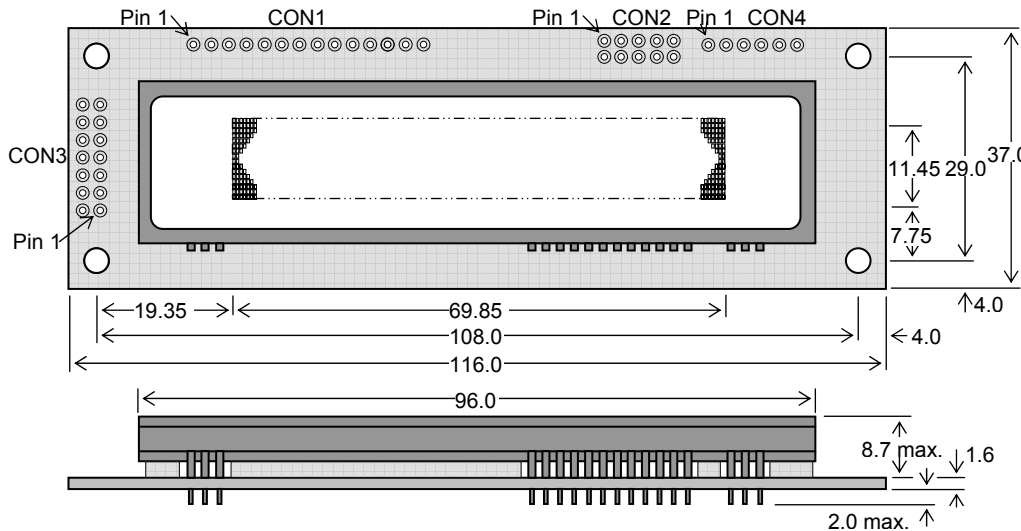

CON2 - SERIAL INTERFACE

Pin	Async	SPI
1	5V	5V
2	NC	SCK
3	RXD	/SS
4	NC	SIN
5	0V	0V
6	NC	SOUT
7	TXD	NC
8	/RES	/RES
9	MB	MB
10	HB	HB

NC = Do Not Connect

CON1/3 - PARALLEL INTERFACE

Pin	Sig	Pin	Sig
1	GND	2	VCC
3	NC*	4	RS
5	R/W	6	E
7	D0	8	D1
9	D2	10	D3
11	D4	12	D5
13	D6	14	D7

*RESET = Jumper J6.1 & J6.2
BUSY = Jumper J6.2 & J6.3

ELECTRICAL SPECIFICATION

Parameter	Symbol	Value	Condition
Power Supply Voltage	VCC	5.0VDC +/- 5%	GND=0V
Power Supply Current	ICC	250mADC typ.	VCC=5V
Logic High Input	VIH	0.8VDC min. Vcc max.	VCC=5V
Logic Low Input	VIL	0VDC min. 0.6VDC max.	VCC=5V
Logic High Output	VOH	3.5VDC min. Vcc max.	IOH=-10uA
Logic Low Output	VOL	0VDC min. 0.6VDC max.	IOL=4mA

OPTICAL and ENVIRONMENTAL SPECIFICATIONS

Parameter	Value
Display Area (XxY mm)	69.85 x 11.45
Dot Size/Pitch (XxY mm)	0.35 x 0.575 / 0.5 x 0.725
Luminance	700 cd/m ² Typ.
Colour of Illumination	Blue-Green (Filter for colours)
Operating Temperature	-40°C to +85°C
Storage Temperature	-40°C to +85°C
Operating Humidity (non condensing)	20 to 80% RH @ 25°C

SOFTWARE COMMAND SUMMARY

Instruction	R/W	RS	D0-D7
Clear Display	L	L	01H
Cursor Return Home	L	L	02H
Entry Mode Set	L	L	04H-07H
Display ON/OFF	L	L	08H-0FH
Cursor Shift Left	L	L	10H
Cursor Shift Right	L	L	14H
Display Shift Left	L	L	18H
Display Shift Right	L	L	1CH
Select 4/8 bit interface	L	L	20H (4Bit) / 30H (8Bit) + <i>luminance</i>
Display Luminance	L	H	00H - 03H (must follow above command)
Set CG RAM Addr.	L	L	40H-7FH
Set DD RAM Addr.	L	L	80H-E7H
Read BUSY/Addr.	H	L	00H-FFH D7 Busy = High
Read Data from RAM	H	H	00H-FFH
Set Graphic Cursor	L	L	F0H + <i>xpos</i> + <i>ypos</i>
Set Area Commands	L	L	F1H + <i>x1</i> + <i>y1</i> + <i>x2</i> + <i>y2</i> + <i>cmd</i> where <i>cmd</i> : 49H = Invert Area 46H = Fill Area 43H = Clear Area 4FH = Set Outline Box 6FH = Clear Outline Box + others for graphic data write
Set Font / Spacing	L	L	F2H + <i>font style</i>
Set RS Low			0FH Serial Comms. only
Read Data			FEH Serial Comms. only
Read Cursor Position			FFH Serial Comms. only

CHARACTER SETS

5x7 & 10x14 Font

00	10	20	30	40	50	60	70	80	90	0A	0B	0C	0D	0E	0F
00		0	@	P	^	~	~	~	~	~	~	~	~	~	~
01		!	A	Q	a	q	a	z	z	z	z	z	z	z	z
02		"	B	R	b	r	B	E	E	E	E	E	E	E	E
03		#	C	S	c	s	C	R	R	R	R	R	R	R	R
04		\$	D	T	d	t	D	U	U	U	U	U	U	U	U
05		%	E	V	e	v	E	O	O	O	O	O	O	O	O
06		&	F	W	f	w	F	V	V	V	V	V	V	V	V
07		'	G	X	g	x	G	Y	Y	Y	Y	Y	Y	Y	Y
08		(H	X	h	x	(Z	Z	Z	Z	Z	Z	Z	Z
09)	I	Y	i	y)	[[[[[[[[
0A		*	J	Z	j	z	J	\	\	\	\	\	\	\	\
0B		+	K	[k	[K	^	^	^	^	^	^	^	^
0C		,	L]	l]	L	_	_	_	_	_	_	_	_
0D		-	M	^	m	^	M	`	`	`	`	`	`	`	`
0E		.	N	^	n	^	N	~	~	~	~	~	~	~	~
0F		/	O	^	o	^	O	~	~	~	~	~	~	~	~

LCD Font

5x7 Font Cyrillic Font

80	90	0A	0B	0C	0D	0E	0F
80	Ѡ	ѡ	Ѣ	ѣ	Ѥ	ѥ	Ѧ
81	ѧ	Ѩ	ѩ	Ѫ	ѫ	Ѭ	ѭ
82	Ѯ	ѯ	Ѱ	ѱ	Ѳ	ѳ	Ѵ
83	ѵ	Ѷ	ѷ	Ѹ	ѹ	Ѻ	ѻ
84	Ѽ	ѽ	Ѿ	ѿ	ѿ	ѿ	ѿ
85	ѿ	ѿ	ѿ	ѿ	ѿ	ѿ	ѿ
86	ѿ	ѿ	ѿ	ѿ	ѿ	ѿ	ѿ
87	ѿ	ѿ	ѿ	ѿ	ѿ	ѿ	ѿ
88	ѿ	ѿ	ѿ	ѿ	ѿ	ѿ	ѿ
89	ѿ	ѿ	ѿ	ѿ	ѿ	ѿ	ѿ
8A	ѿ	ѿ	ѿ	ѿ	ѿ	ѿ	ѿ
8B	ѿ	ѿ	ѿ	ѿ	ѿ	ѿ	ѿ
8C	ѿ	ѿ	ѿ	ѿ	ѿ	ѿ	ѿ
8D	ѿ	ѿ	ѿ	ѿ	ѿ	ѿ	ѿ
8E	ѿ	ѿ	ѿ	ѿ	ѿ	ѿ	ѿ
8F	ѿ	ѿ	ѿ	ѿ	ѿ	ѿ	ѿ

00	01	02	03	04	05	06	07	08	09	0A	0B	0C	0D	0E	0F
20	!	!	!	!	!	!	!	!	!	!	!	!	!	!	!
30	0	1	2	3	4	5	6	7	8	9	:	<	#	>	?
40	@	A	B	C	D	E	F	G	H	I	J	K	L	M	N
50	P	Q	R	S	T	U	V	W	X	Y	Z	[]	^	_

FONT SELECTION

J3	Font
Open	LCD (default)
Link	Cyrillic

SERIAL/PARALLEL SELECTION

J8	Interface
Open	Parallel (default)
Link	Serial

SERIAL MODE

J9	J10	Configuration
O	O	SPI / Clock Serial (def)
L	O	Async 9600,N,8,1
O	L	Async 19200,N,8,1
L	L	Async 38400,N,8,1

The default font can be changed by J3. Other fonts can then be selected by software command.

CONTACT

Noritake Sales Office Tel Nos
Nagoya Japan: +81 (0)52-561-9867
Canada: +1-416-291-2946
Chicago USA: +1-847-439-9020
Munchen (D): +49 (0)89-3214-290
Itron UK: +44 (0)1493 601144
Rest Europe: +49 (0)61-0520-9220
www.noritake-itron.com

Subject to change without notice.
IUK Doc Ref: 04754 Iss:1 14Oct04

Copyright 2003 Noritake Itron Corp. Japan

SOFTWARE COMMANDS

Instruction	Data Format (RS = 1)	Description
UDF Write	00H – 0FH	Write user defined character 1-8 to the current cursor location on the display.
Data Write (40us – LCD compatible mode) (250us – Graphic mode)	00H – FFH	Write data to the display. In normal (LCD compatible) mode of operation, data is written to the display data (DD RAM) or character generator (CG RAM). When using the graphical data commands (F0H, F1H & F2H), data is written direct to the display and is not stored in DD RAM. Data write busy times will increase when using the graphic functions.
Instruction	Data Format (RS = 0)	Description
Display Clear (150us)	01H	Fills all locations in the display data (DD) RAM with 20H (blank character). The address counter is set to 0 in the DD RAM. The address counter is set to increment on each data read/write. Any display offset (using the display shift command) is removed.
Cursor Home (500us)	02H	The address counter is set to 0 in the DD RAM. Any display offset (using the display shift command) is removed.
Entry Mode ^{*Note1} (40us)	04H – 07H	Bit 1 is used to select the direction of the address counter on each data read or write. If set to '1', the address counter is incremented. If set to '0', the address counter is decremented. Bit 0 enables the display to shift on each data read/write. If this bit is set to '1', the display is shifted with the cursor. The display shift direction depends upon the address counter direction (bit1). If this is set to increment, the display is shifted left, if the address counter is set to decrement, the display is shifted right.
Display Control ^{*Note2} (50us)	08H-0FH	Bit 2 is used to enable or disable the display. If this bit is set to '0' the VFD's power supply is turned off to reduce power consumption. Bit 0 enables the flashing block cursor.
Cursor Shift Left (40us)	10H	Shift the cursor position (address counter) one position to the left.
Cursor Shift Right (40us)	14H	Shift the cursor position (address counter) one position to the right.
Display Shift Left (150us)	18H	Shift the display left, one character position.
Display Shift Right (150us)	1CH	Shift the display right, one character position.
Select 4 bit interface (40us)	20H + lum (RS=1)	Enables 4-bit communications. Data is received on DB4-DB7 only. Two writes are required to send one data byte. The most significant nibble should be sent first. Refer to the 'Parallel Communications' section for more information. The lum value sets the displays brightness, and must be sent with the RS line high: - 00H = full brightness, 01H = 75%, 02H = 50% & 03H = 25%.
Select 8 bit interface (40us)	30H + lum (RS=1)	Enables 8-bit communications. Data is received on DB0-DB7. The lum value sets the displays brightness, and must be sent with the RS line high: - 00H = full brightness, 01H = 75%, 02H = 50% & 03H = 25%.
Set CG Address (40us)	40H – 7FH	Set the character generator address (CG RAM). All written data is placed within the user definable character area.
Set DD Address (40us)	80H – E7H	Set the display data address (DD RAM). 80H - 8FH = top line. C0H - CFH = bottom line.
Set Graphic Cursor ^{*Note3} (40us)	F0H + xpos + ypos	Set the absolute cursor position. xpos = 0 – 139, ypos = 0 – 15. Co-ordinates should be written with RS line set high.
Set Area ^{*Note3} (40us + 500us(cmd byte))	F1H + x1 + y1 + x2 + y2 + cmd	Area Commands: - 'I' – invert area. 'F' – fill area. 'C' – clear area. 'O' – set outline. 'o' – clear outline. 'H' – write horizontal graphical data with horizontal cursor movement. 'V' – write vertical graphical data with horizontal cursor movement. 'h' – write horizontal graphical data with vertical cursor movement. 'v' – write vertical graphical data with vertical cursor movement. All area commands should be proceeded with the area co-ordinates. X1 Y1 left top X2 Y2 bottom right. Graphical data should immediately follow the 'H','h','V' and 'v' commands. Co-ordinates, command and graphical data should be written with RS line set high.
Set Font ^{*Note3} (40us)	F2H + font	Select font type, font size and font spacing. Font commands: - 'A' or 'a' = proportional 64 character mini-font. 'B' = 5x7 LCD compatible font with Katakana characters. 'C' = 10x14 LCD compatible font with Katakana characters. 'b' = 5x7 cyrillic font. '1' = set the inter-character pixel spacing to 1 pixel. '2' = set the inter-character pixel spacing to 2 pixels. Font command should be written with RS line set high.
Instruction	Data Format	Additional Serial Data Commands
Set RS Low	0FH	Set the RS line low for the following byte only. Used in serial communications only.
Read Data	FEH	Read data at current cursor position. This command is used with serial communications only.
Read Cursor Position	FFH	Read current cursor position. This command is used with serial communications only.

- Notes: -
1. When display shift is enabled, the data write busy time can increase by 200us.
 2. If the cursor is enabled, busy times can increase by 20us.
 3. After these commands are executed, the cursor will be disabled and any character data will be written to the display only, and not the DD RAM. Any subsequent LCD compatible command will re-enable the cursor and allow for DD RAM writing.

GRAPHICAL DATA WRITES

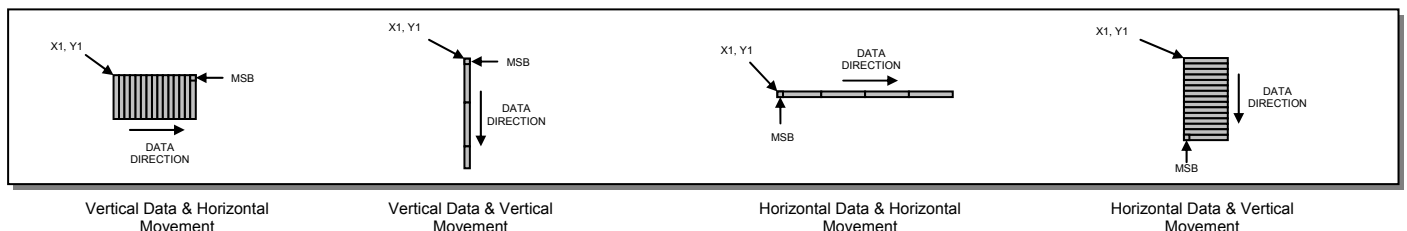

PARALLEL COMMUNICATIONS

This module has a fast latching 8-bit data bus. The 'RS' and 'R/W' control lines should be set prior to the rising edge of the 'E' enable line. Data is clocked in on the falling edge of the enable line. The busy line should be checked before sending data.

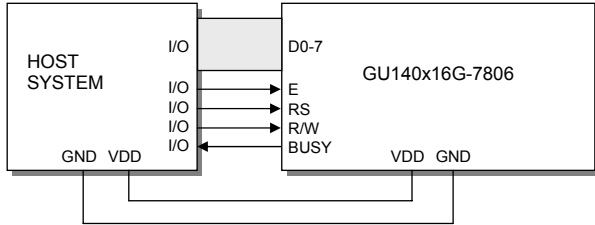

The busy state can be monitored on D7 when reading the DDRAM address (RS line low). The busy state can also be monitored directly from CON1 pin 3 if link J6 is set to 2&3.

Please note that the busy line has an open collector output with a 47K pull-up resistor, and is highly susceptible to loading.

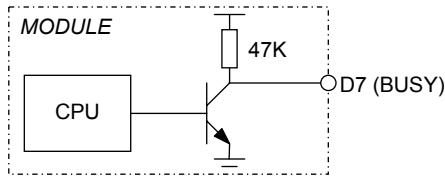

The data bus width can be selected for 4-bit operation, using data lines D4-D7. Within this mode, two writes are required to send one data byte. The high nibble (bits 4-7) should be sent first, followed by the low nibble (bits 0-3). The busy state cannot be read between nibbles, although it can be monitored on CON1 pin 3.

8-Bit Data Write Timing Diagram.

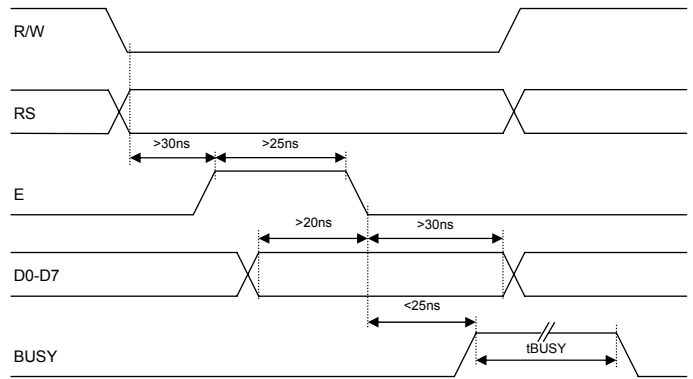

8-Bit Data Read Timing Diagram.

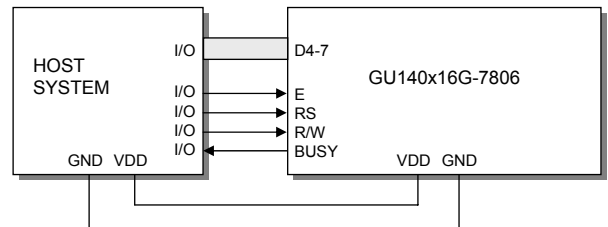
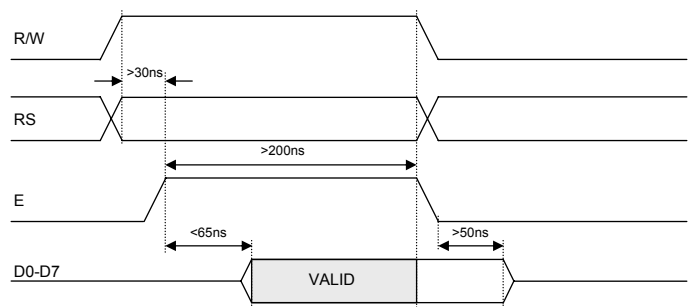

4-Bit Data Write Timing Diagram.

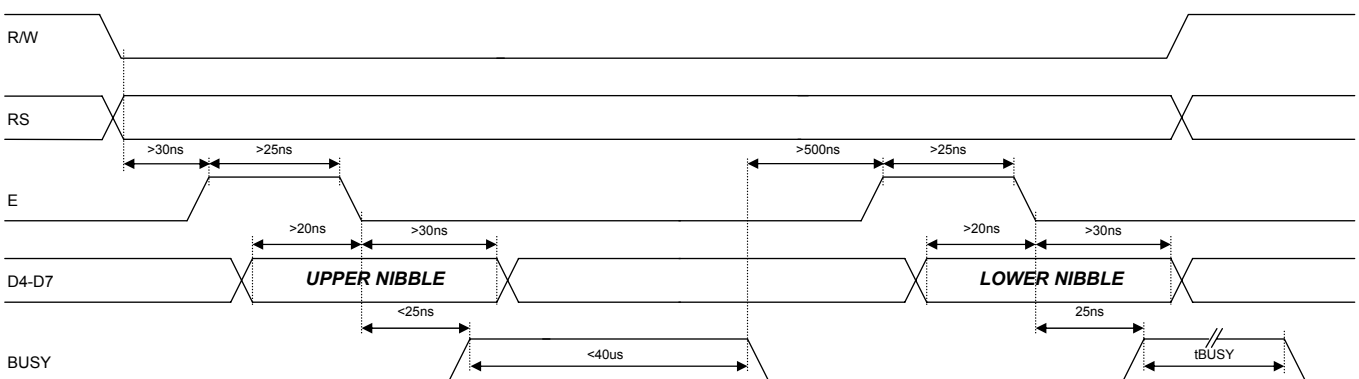

ASYNCHRONOUS SERIAL COMMUNICATION

Asynchronous & synchronous serial interfaces are provided at TTL level. Link J8 on the rear of the module to enable the serial communications. When using serial communications, the module is automatically initialised at power-up/reset with the cursor enabled. Jumper links J8 and J9 are used to select synchronous serial mode or asynchronous baud rate & parity.

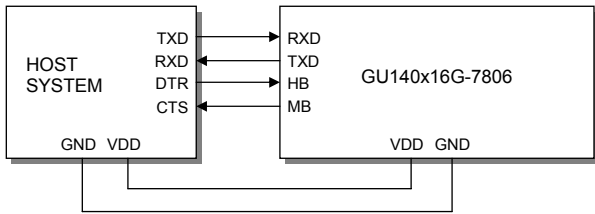

Host to Module Write

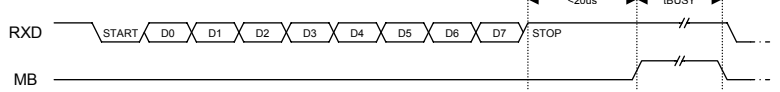

Module to Host Write

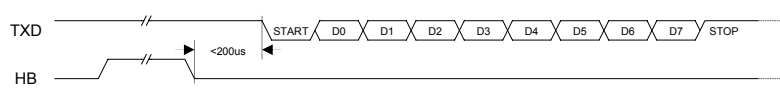

The host busy line (HB) stops the module from sending data to the host. The use of the HB and MB lines are optional, and can be connected together if not required.

SYNCHRONOUS SERIAL COMMUNICATION

With synchronous communications enabled, data can be clocked into the VFD module on the rising edge of SCK, with the MSB sent first. The host must provide adequate delays for the module to process the data, these busy times are specified in the software command section. Alternatively the host can monitor the MB (Module Busy) line.

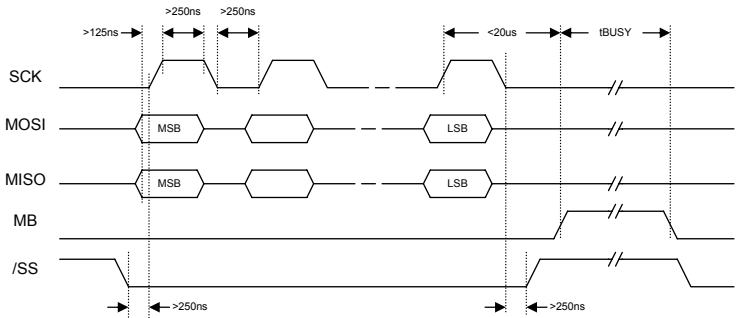
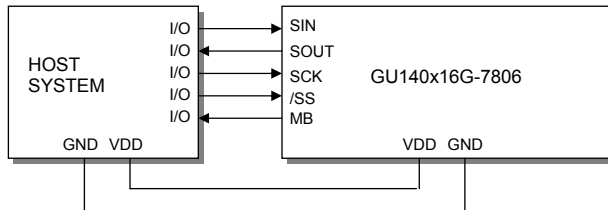

TTL Synchronous serial communication.

The /SS pin can be used as an enable pin if other devices are connected to the serial line, and also allows byte synchronisation. The use of the /SS line is recommended, but can be permanently pulled low if not required.

SERIAL CONTROL

An additional command has been included to distinguish between command and data writes when using serial communications. This command (0FH) will temporarily set the RS line low for the subsequent written byte. The following example displays two text messages using the serial communications and the 'Set RS' command: -

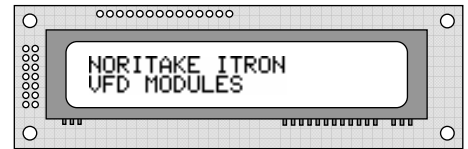
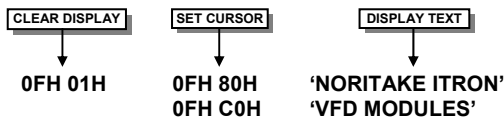

Displaying text using serial communications.

LCD COMPATIBLY

This module features a command set that is LCD compatible, allowing easy replacement in existing equipment with little or no modifications. Careful consideration should be taken regarding the command execution times of this module. Although the commands can be executed within 40us, which is normal for LCD, busy times are increased when using the scroll write modes and with the cursor enabled. When using the 4-bit parallel mode, a 40us delay is required between nibbles. Also reading back data in 4-bit parallel mode is not supported. DD RAM address locations 70H+ are used to access the extended graphic commands.

At power up and reset the module is automatically initialised and ready to receive data. The interface is set to 8-bit, the display is cleared, the cursor position is set to the top-left corner (DD RAM address = 00H), and the display luminance is set to 100%.

EXTENDED GRAPHIC COMMANDS

In addition to the standard LCD commands, this module includes additional commands to display graphical data and different font sizes. When any of these extended commands are executed, the module will change to the 'graphics' mode of operation. This graphics mode allows text to be written to any part of the display.

There are many differences the user should be aware of when the display is in this graphics mode: -

- Written data may require additional busy times.
- Text data is not written into the DD RAM and therefore can not be read back.
- Graphical text can not be shifted onto the display.
- The cursor is disabled & cursor direction is set to increment only.
- UDF characters cannot be written.

The graphics mode is disabled as soon as any valid LCD command is received.

DISPLAYING GRAPHICAL TEXT

The module contains 3 font sizes, a proportional mini-font, 5x7 pixel, and a 10x14 pixel font. Graphical text can be written to any part of the display using the 'Set Graphic Cursor' command (F0H). Characters are positioned above the current cursor position. Each character written will include either a one pixel or two pixel space to the right side of the character. After each character is written to the display, the cursor position is automatically advanced. If the cursor position reaches the end of the display, the host must reposition to the next line.

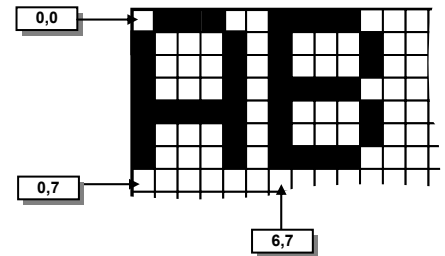

Cursor Positioning, example of writing 2 characters from cursor position 0,7.

The following example displays two text messages in the center of the display using the standard 5x7 character font. Command bytes that are underlined should be sent with RS line low.

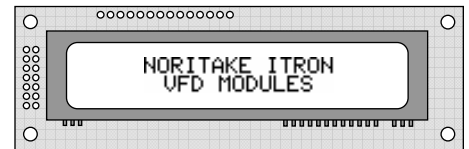
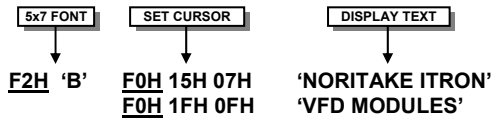

Displaying text using the 5x7 font.

The next example displays one line of text using the 10x14 character font. Command bytes that are underlined should be sent with RS line low.

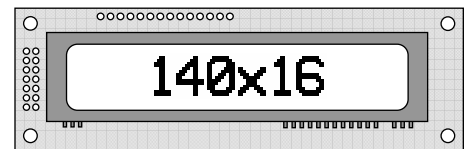
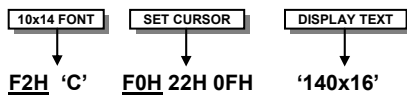

Displaying text in the large 10x14 font.

DISPLAYING GRAPHICS

Graphical images can be displayed on the VFD module in either a horizontal or vertical byte orientation. After each graphical data write, the cursor is automatically advanced. All graphical data is contained within the defined area. Unused bits are masked where the screen area is not a byte multiple

The following example displays a simple graphical image. The graphical data orientation is set to horizontal data format, with a vertical cursor movement. Command bytes that are underlined should be sent with RS line low.

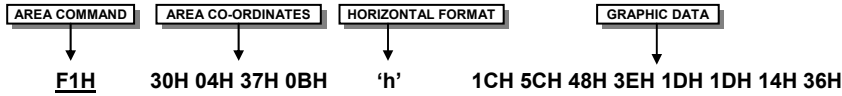

The next example displays a simple graphical image using a vertical data format, with a horizontal cursor movement. Command bytes that are underlined should be sent with RS line low.

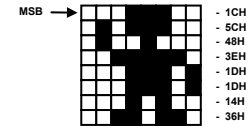
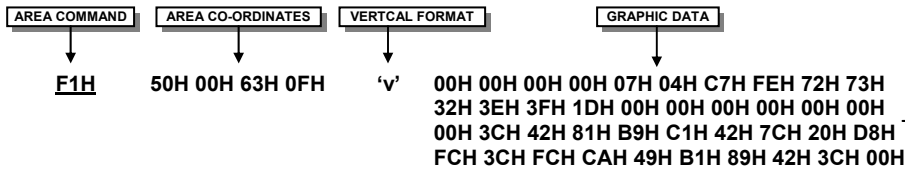

Graphic Image using horizontal data

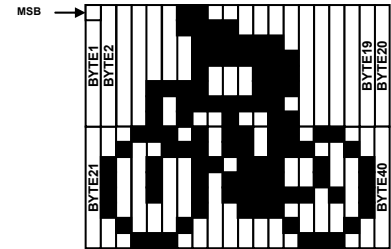

Graphic Image using vertical data

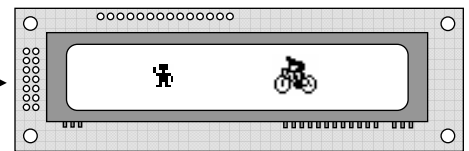

Displaying graphic images in vertical and horizontal format.

AREA COMMANDS

The VFD module contains commands to fill, clear and invert defined areas of the display. Also an outline command is available to draw rectangles around objects.

The following example displays three options for the user to select, each option is contained within a box with a shadow effect. Drawing horizontal and vertical lines using the fill area command creates the shadow effect. Command bytes that are underlined should be sent with RS line low.

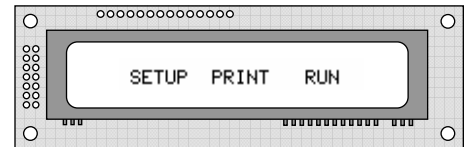
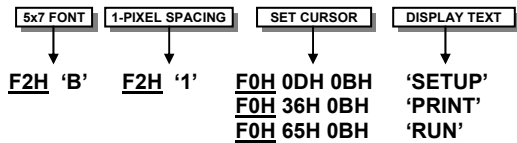

Display options with simple graphic text write.

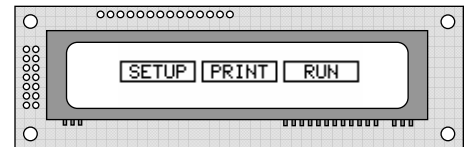
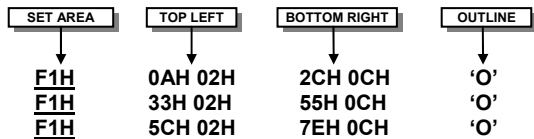

Boxes created using the 'Set Area Outline' command.

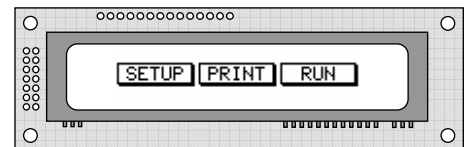
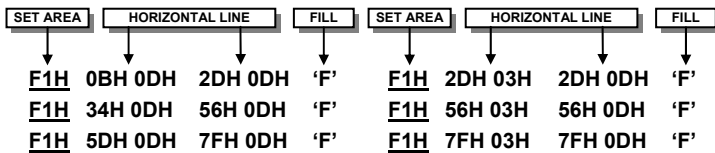

Drop Shadows created with the 'Fill Area' command.

The next example uses the invert area command to select one of the options.

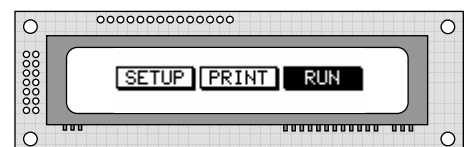
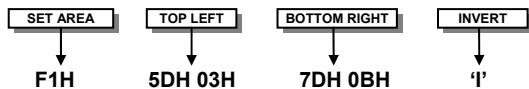

Option 'Run' selected with the 'Invert Area' command.