

**Vacuum Fluorescent Display Module**  
**256x32dots Type 39xx series**  
**“General Function”**  
**Software Specification**

Model: GU256X32D-39xx series

Specification No: DS-1016-0003-02  
Date Of Issue: April 25, 2003 (00)

Revision: August 29, 2005 (01)  
January 16, 2009 (02)

Published by  
NORITAKE ITRON Corp. / Japan  
<http://www.noritake-itron.jp/>

This specification is subject to change without prior notice.

Index.....	
<b>1 General Description .....</b>	<b>3</b>
1.1 Scope .....	3
1.2 Function .....	3
<b>2 Operating mode .....</b>	<b>3</b>
2.1 Normal command mode.....	3
2.2 Graphic DMA mode.....	3
2.3 User setup mode.....	3
2.4 Memory re-write mode.....	3
2.5 Test mode.....	3
2.6 The setting at power on.....	3
<b>3 Normal command mode (Applying for Parallel, RS-232 serial interface) .....</b>	<b>4</b>
3.1 Displayable image types.....	4
3.1.1 Graphic display.....	4
3.1.2 Character display.....	4
3.2 Memory.....	4
3.2.1 Display memory.....	4
3.2.2 Memory for Bit image definition.....	4
3.2.3 Memory for Download character definition, and FROM User font defintion.....	4
3.3 Cursor.....	5
3.4 Window.....	6
3.4.1 Base-Window.....	6
3.4.2 User-Window.....	6
3.5 Write screen mode.....	7
3.5.1 Display screen mode.....	7
3.5.2 All screen mode.....	7
3.6 Protocol.....	8
3.6.1 Direct mode.....	8
3.6.2 Packet mode.....	8
3.7 Commands.....	8
3.7.1 Code set.....	8
3.7.1.1 Character code.....	8
3.7.1.2 Control code.....	8
3.7.2 Detail of code set.....	8
3.7.2.1 Character display.....	8
3.7.2.2 BS (Back Space).....	12
3.7.2.3 HT (Horizontal Tab).....	12
3.7.2.4 LF (Line Feed).....	13
3.7.2.5 HOM (Home Position).....	14
3.7.2.6 CR (Carriage Return).....	14
3.7.2.7 CLR (Display Clear).....	14
3.7.3 Command Set.....	15
3.7.3.1 General setting commands.....	15
3.7.3.2 Character display setting commands.....	15
3.7.3.3 Display action setting commands.....	16
3.7.3.4 Bit image display setting commands.....	16
3.7.3.5 General display setting commands.....	18
3.7.3.6 Window display setting commands.....	18
3.7.3.7 Download character setting commands.....	18
3.7.3.8 User setup mode setting commands.....	19
3.7.3.9 General purpose I/O Port control commands.....	19
3.7.3.10 Macro setting commands.....	19
3.7.3.11 Other setting commands.....	19
3.7.4 Detail of Command Set.....	20
3.7.4.1 US X n (Brightness level setting).....	20
3.7.4.2 ESC@ (Initialize Display).....	20
3.7.4.3 US \$ x y (Cursor Set).....	20
3.7.4.4 US ( d n (Cursor display ON/OFF select).....	20
3.7.4.5 US ( w n a (Write screen mode select ).....	21
3.7.4.6 ESC R n (Specifies International font set).....	21
3.7.4.7 ESC t n (Specifies character code type).....	22
3.7.4.8 US MD1 (Over-write mode).....	22
3.7.4.9 US MD2 (Vertical scroll mode).....	22
3.7.4.10 US MD3 (Horizontal scroll mode).....	22
3.7.4.11 US s n (Horizontal scroll speed).....	22
3.7.4.12 US ( g n m (Font size select).....	23
3.7.4.13 US ( g n m (Specify-Cancel 2byte character mode).....	23
3.7.4.14 US ( g n m (Select 2byte character type).....	23
3.7.4.15 US ( g n x y (Font magnified display).....	23
3.7.4.16 US ( g n b (Character bold display).....	24
3.7.4.17 US ( a n t (Wait).....	24
3.7.4.18 US ( a n t (Short Wait).....	24

3.7.4.19	US ( a n wL wH cL cH s (Scroll display action) .....	24
3.7.4.20	US ( a n p t1 t2 c (Display Blink) .....	25
3.7.4.21	US ( a n v s p (Curtain display action) .....	26
3.7.4.22	US ( a n v s pL pH (Spring display action) .....	26
3.7.4.23	US ( a n s pL pH (Random display action) .....	27
3.7.4.24	US ( a n p (Display power ON/OFF) .....	28
3.7.4.25	US ( d n pen xL xH yL yH (Dot pattern drawing) .....	28
3.7.4.26	US ( d n mode pen x1L x1H y1L y1H x2L x2H y2L y2H (Line/Box pattern drawing) .....	28
3.7.4.27	US ( f n xL xH yL yH g d(1)...d(k) (Real-time bit image display) .....	29
3.7.4.28	US ( f n aL aH aE sL sH sE d(1)...d(s) (RAM bit image definition) .....	30
3.7.4.29	US ( e n aL aH aE sL sH sE d(1)...d(s) (FROM bit image definition) .....	31
3.7.4.30	US ( f n m aL aH aE ySL ySH xL xH yL yH g) (Downloaded bit image display) .....	33
3.7.4.31	US ( f n m aL aH aE ySL ySH xL xH yL yH g s) (Downloaded bit image scroll display) .....	35
3.7.4.32	US m n (Horizontal scroll display quality select) .....	37
3.7.4.33	US r n (Specifies or cancels reverse display) .....	37
3.7.4.34	US w n (Specifies write mixture display mode) .....	37
3.7.4.35	US ( w n a (Current Window select) .....	37
3.7.4.36	US ( w n a b[xPL xPH yPL yPH xSL xSH ySL ySH] (User Window definition-cancel) .....	38
3.7.4.37	ESC % n (Specify Download Character) .....	39
3.7.4.38	ESC & a c1 c2 [x1 d1...d(y*x1)]...[xk d1...d(y*xk) (Download character definition) .....	39
3.7.4.39	ESC ? a c (Delete downloaded character) .....	39
3.7.4.40	US ( g n c1 c2 d1...dk (16x16 download character definition) .....	40
3.7.4.41	US ( g n c1 c2 (16x16 downloaded character delete) .....	40
3.7.4.42	US ( e n a (Save downloaded character) .....	40
3.7.4.43	US ( e n a (Download character transfer) .....	41
3.7.4.44	US ( e n m P(80h-1) P(80h-2)...P(FFh-n) (FROM User font definition) .....	41
3.7.4.45	US ( e n d1 d2 (User set up mode start) .....	41
3.7.4.46	US ( e n d1 d2 d3 (User set up mode - end) .....	41
3.7.4.47	US ( p 01h n a (I/O Port Input/Output setting) .....	42
3.7.4.48	US ( p 10h n a (I/O Port Output) .....	42
3.7.4.49	US ( p 20h n (I/O Port Input) .....	42
3.7.4.50	US : pL pH [d1...dk] (RAM Macro processing definition) .....	43
3.7.4.51	US ( e n a pL pH t1 t2 [ d(1)...d(p) ] (FROM Macro processing definition) .....	44
3.7.4.52	US ^ n t1 t2 (Macro execution) .....	44
3.7.4.53	US ( e n a b (Memory SW setting) .....	45
3.7.4.54	US ( e n a (Memory SW data send) .....	45
3.7.4.55	US ( e n a [b c ] (Display status send) .....	45
3.7.4.56	FS   M m d1...d6 (Memory re-write mode shift) .....	46
3.8	Bit image data format .....	47
3.9	Download character format .....	47
<b>4</b>	<b>Graphic DMA mode (Applying for Parallel interface only) .....</b>	<b>48</b>
4.1	Displayable image types .....	48
4.1.1	Graphic display .....	48
4.2	Display memory .....	48
4.3	Protocol .....	48
4.4	Commands .....	49
4.4.1	STX 44H DAD 46H aL aH sL sH d1...ds (Bit image write) .....	49
4.4.2	STX 44H DAD 42H aL aH sXL sXH sYL sYH d1...ds (BOX Area Bit image write) .....	50
4.4.3	STX 44H DAD 53H aL aH (Specify Display start address) .....	50
4.4.4	STX 44H DAD 57H 01H (Specify Display synchronization) .....	51
4.4.5	STX 44H DAD 58H n (Brightness level setting) .....	51
<b>5</b>	<b>Setup .....</b>	<b>52</b>
5.1	DIP-Switch (SW1) .....	52
5.1.1	Display address select (Applying for Packet mode and Graphic DMA mode) .....	52
5.1.2	Baud rate select (Applying for RS-232 interface) .....	52
5.1.3	Command Mode select .....	52
5.1.4	Operating Mode select .....	52
5.1.5	Protocol mode select .....	52
5.2	Memory SW .....	53
<b>Notice for the Cautious Handling VFD Modules .....</b>		<b>54</b>
<b>Revision Note .....</b>		<b>55</b>

## 1 General Description

### 1.1 Scope

This specification covers the software programming and its requirements of the vacuum fluorescent graphic display module GU256X32D-39xx series. This specification is applied for firmware version of F33xB24x. Please contact us if specification for other firmware version is need.

**Relational spec.:** GU256X32D-3xxx Hardware specification  
 Program Macro specification: (Refer to 3.7.4.50 RAM Macro processing definition)  
 (Refer to 3.7.4.51 FROM Macro processing definition)  
 Character fonts specification: (Refer to 3.1.2 Character display)

### 1.2 Function

Character display, Graphic display  
 Control command, Display action command,  
 Download(user definable)font, User definable font table function  
 Draw command, Window function, General Purpose I/O port control  
 Macro, Program Macro function, Bit Image download function  
 Memory SW

## 2 Operating mode

There are some of operating modes, and it is selectable by DIP-SW or TEST Terminal as follows;

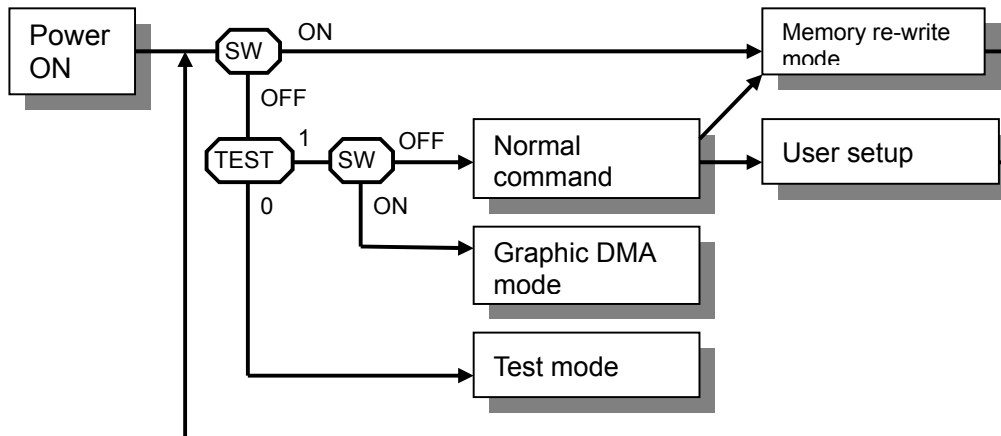

### 2.1 Normal command mode

This is one of Normal operation mode, and the module can receive the data/command via each interface. There are two types of protocol for data/command, and they are selectable by DIP-SW.

### 2.2 Graphic DMA mode

This is one of normal operation mode, and the module can receive the graphic data/command via parallel interface with high-speed data writing. High-speed graphic display is possible using this mode.

### 2.3 User setup mode

This is setup mode for saving Memory-SW and each data to FROM.

### 2.4 Memory re-write mode

This is memory re-write mode for re-writing the font data, firmware, e.t.c.  
 Please do not use this mode if no need to re-write.

### 2.5 Test mode

This is test mode for testing the internal function. This is specially used at factory.

### 2.6 The setting at power on.

The setting at power-on will be default setting value or memory SW setting value. (Refer 5.2 Memory SW). In case of "Transfer at power-on" is ON, The each contents of FROM is transferred to the RAM, and move to standard operating condition. In case of "Macro execution at power-on" in ON, Macro or Program Macro is automatically executed.

### 3 Normal command mode (Applying for Parallel, RS-232 serial interface)

#### 3.1 Displayable image types

##### 3.1.1 Graphic display

Number of dot: 256 x 32 dots

##### 3.1.2 Character display

Character mode: **1 byte character:** 6 x 8 dot, 8 x 16 dot, 16x32 dot character mode  
**2 bytes character:** 16 x 16 dot character mode

Built-in Character font type: **1 byte character:** 6 x 8 dot, 8 x 16 dot, 16x32 dot  
 – ANK, International font, refer to spec. DS-874-0004-XX  
**2byte character:** 16x16 dot character  
 – Japanese Kanji, refer to spec. DS-906-0002-XX  
 – Simplified Chinese, refer to spec. DS-954-0006-XX  
 – Traditional Chinese, refer to spec. DS-954-0007-XX  
 – Korean, refer to spec. DS-954-0008-XX

#### 3.2 Memory

##### 3.2.1 Display memory

Size: 1,024 x 32 dots - separated as: Display area (256x32dots), Hidden area (768x32dots).

By using "User Window" function, all display area can be separated, and each window separated can be controlled independently. Refer "3.7.4.36 User Window definition-cancel".

Hidden area also can be displayed by using display action command. Refer "3.7.4.19 Scroll display action, e.t.c..

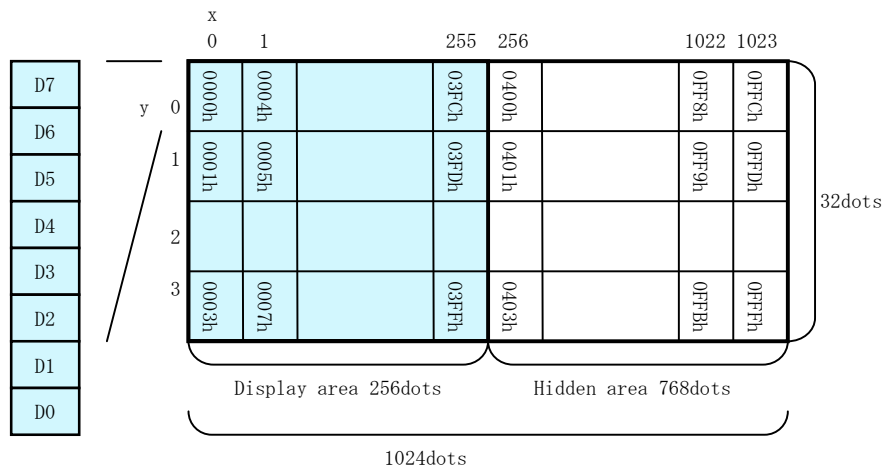

##### 3.2.2 Memory for Bit image definition

Bit image can be defined and stored into following each memory by bit image definition command.

**RAM: 1,024 bytes**

**FROM: 32,768 bytes + Extension area 262,144 bytes.**

Refer to 3.7.4.28 "RAM Bit image definition" and 3.7.4.29 "FROM Bit image definition"

##### 3.2.3 Memory for Download character definition, and FROM User font definition

Memory for User definable character function is available as follows;

**6x8, 8x16 1byte character and 16x16 2 byte character : Download character definition**

Max16 characters for each can be defined to the memory space prepared on RAM.

**6x8, 8x16, 16x32 1byte character: FROM user font definition**

Max128 characters for each can be defined to the memory space prepared on FROM.

Refer to the 3.7.4.38 "Download character definition", 3.7.4.40 16x16 download character definition and 3.7.4.44 "FROM User font definition".

### 3.3 Cursor

Cursor indicates the write start position at the time of displaying a character and a bit image.  
 Cursor consists of 1 dot horizontally and 8 dots vertically.  
 Character and Bit image is written to the vertically for X direction and Horizontally for Y direction from Cursor position. "  
 Cursor position can be moved by "Cursor set" Command. Refer to 3.7.4.3 "Cursor set"

The position relation between cursor and all display memories is as follows.

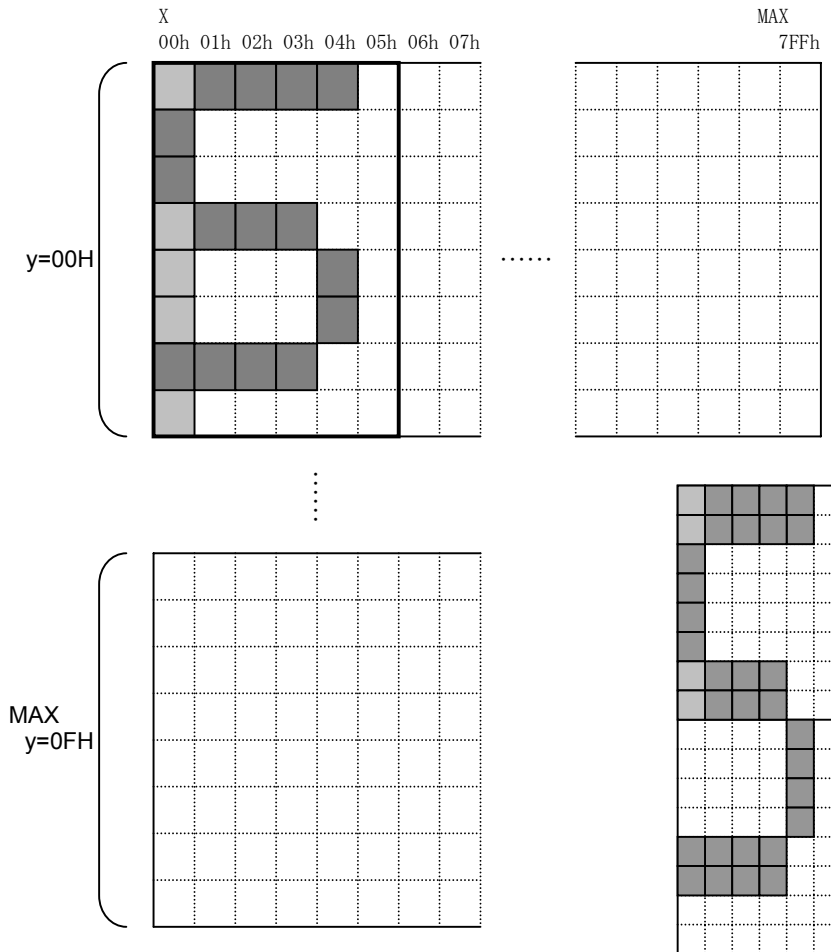

Example: Vertically 2x character

### 3.4 Window

Window function divides display screen as "Window", and each divided "Window" can be controlled and displayed independently. Refer to "3.7.4.36 User Window definition-cancel".

There are no independent display memories for each "Window".

There are 2 types of "Window", Base-Window and User-Window.

#### 3.4.1 Base-Window

This has the whole display screen and if User-Window is not defined, all display operation is processed under this Base-Window.

When some User-Window is defined, the display operation to the out of display screen of User-Window should be processed under Base-Window.

When Base-Window is selected even if some User-Window is defined, all of display operation is processed under Base-Window. Therefore, the current display pattern of User-Window is overwritten.

The operation on Base-Window is depend on the condition of "Write screen mode" select. Refer to 3.5 Write screen mode.

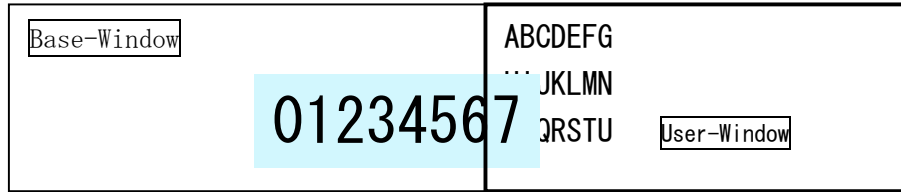

#### 3.4.2 User-Window

User-Window is defined by command, and display operation can be processed on User-Window selected by "Current Window select" command.

User-Window can be defined up to 4 windows.

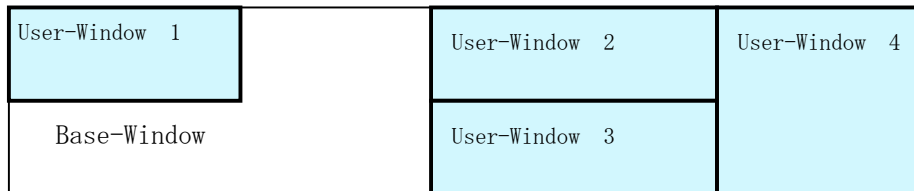

### 3.5 Write screen mode

**This effects only for Base Window.**

There are two types of Write screen mode, Display screen mode and All screen mode which can be changed by command. Refer to "3.7.4.5 Write screen mode select"

#### 3.5.1 Display screen mode

When the cursor is located on the Display area, all of operation will be done within Display area, and when cursor is located on the Hidden area, it will be done within Hidden area.

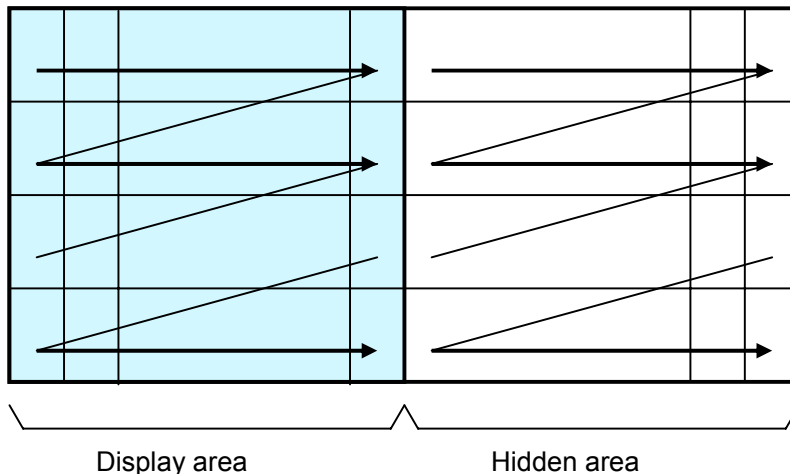

#### 3.5.2 All screen mode

All of operation will be done on all of area.

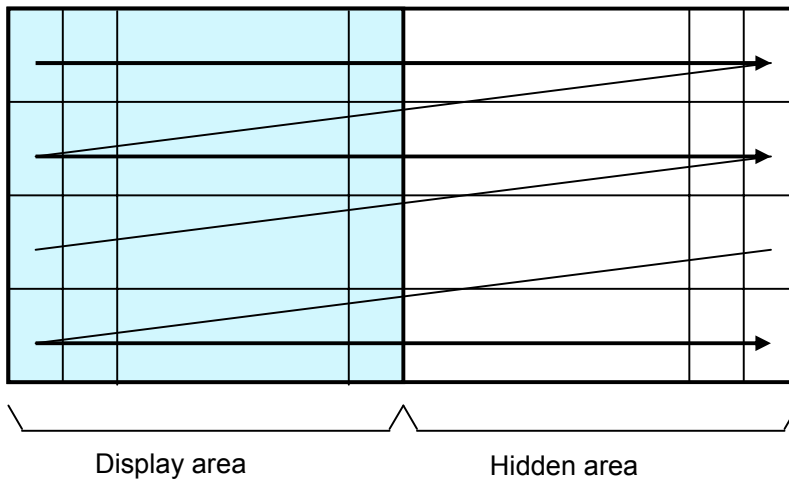

Note: Operation of character and bit image write based on each screen mode.

Character write: Cursor moving depends on specified character display mode.

Bit Image: If the size of data overflows from the area, it is displayed until edge of area, and remaining bit image overflowed is ignored.



### 3.6 Protocol

There are 2 types of protocols, and they are selectable by DIP-SW.

#### 3.6.1 Direct mode

The module transacts any type of data, the display address setting by DIP SW on module is ignored.  
**It applies for all type of interface.**

#### 3.6.2 Packet mode

The data corresponding between the addresses of DIP SW and display address are transacted. Under this packet mode, 16 pcs (max) of display can be controlled independently. Each display needs to be addressed by the DIP switch. If the address data is defined as FFH, all of modules cascaded accept the same data.

**It applies for parallel and RS-232 serial interface.**

Header	Address	Data length	Data	Footer	BCC
STX (02h)	00h~FFH	01h~80H	00h~FFH	ETX(03H)	00H~FFH
1byte	1byte	1byte	1~128byte	1byte	1byte

BCC: XOR Value about from Header to Footer.

### 3.7 Commands

The details of each command as follows;

Note: The size of character (X x Y dot) described in this section is depending on the command of "Font size select" or "Font magnified display".

#### 3.7.1 Code set

##### 3.7.1.1 Character code

Command Name	Hex Code	Operation	Page
Character display	20H – FFH or 2bytes character code	Display character to the cursor position.	P8

##### 3.7.1.2 Control code

Command Name	Hex Code	Operation	Page
BS Back Space	08H	The cursor moves to left by one character.	P12
HT Horizontal Tab	09H	The cursor moves to right by one character.	P12
LF Line Feed	0AH	The cursor moves to one lower line.	P13
HOM Home Position	0BH	The cursor moves to the home position (Most top left)	P14
CR Carriage Return	0DH	The cursor moves to left end of same line.	P14
CLR Display Clear	0CH	The display screen is cleared and the cursor moves to home position	P14

#### 3.7.2 Detail of code set

##### 3.7.2.1 Character display

###### Code: 20H – FFH or 2bytes character code

Name: Character display

Function: Display the character on cursor position.

The font size can be selected, 6x8, 8x16, 16x32 by "3.7.4.12 Font size select"

To display 2bytes character, the following sequence should be required.

"Font size select" = 8x16dot, m=02H

"Specify-Cancel 2byte character mode" = Specify, m=01H

"Select 2byte character type" = Japanese, Korean, Simplified or Traditional Chinese

Refer to 3.7.4.13 Specify-Cancel 2 byte character mode, and 3.7.4.14 Select 2 byte character type for detail.

The 2 byte character code is depending on the type of character font equipped.  
This module equip following 2 byte character font.

Font type	Code type	First byte	Second byte
Japanese	JIS X0208 (Shift-JIS)	81H ≤ c1 ≤ 9FH, E0H ≤ c2 ≤ EFH	40H ≤ c2 ≤ 7EH, 80H ≤ c2 ≤ FCH
Korean	KSC5601-87	A1h ≤ c1 ≤ Feh	A1h ≤ c2 ≤ FEh
Simplified Chinese	GB2312-80	A1h ≤ c1 ≤ FEh	A1h ≤ c2 ≤ FEh
Traditional Chinese	Big-5	A1h ≤ c1 ≤ FEh	40H ≤ c2 ≤ 7EH, A1H ≤ c2 ≤ FEH

This command effects on the current window selected by "Current window select".

When MD1 (Over-write mode) is selected.

Cursor position		Figure Number	Display Operation
X direction	Y direction		
The space for 1 character size is in right side.	The space for 1 character size in current cursor position.	①	1, Display character on cursor 2, HT execution
	No space for 1 character size in current cursor position.	②	1, The cursor moves to the left end of top line. (OP3) 2, Display character on cursor 3, HT execution
No space at the right end.	The space for 1 character size is in lower line from current cursor position.	③	1, Display space on cursor (OP1) 2, The cursor moves to the left end of one lower line. (OP5) 3, Display character on cursor 4, HT execution
	No space for 1 character size in lower line from current cursor position.	④	1, Display space on cursor(OP1) 2, The cursor moves to the left end of top line. (OP2) 3, Display character on cursor 4, HT execution
	No space for 1 character size in current cursor position.	⑤	1, The cursor moves to the left end of top line. (OP2) 2, Display character on cursor 3, HT execution

**Note:** HT execution is depending on cursor position after displayed. Refer to 3.7.2.3 Horizontal Tab

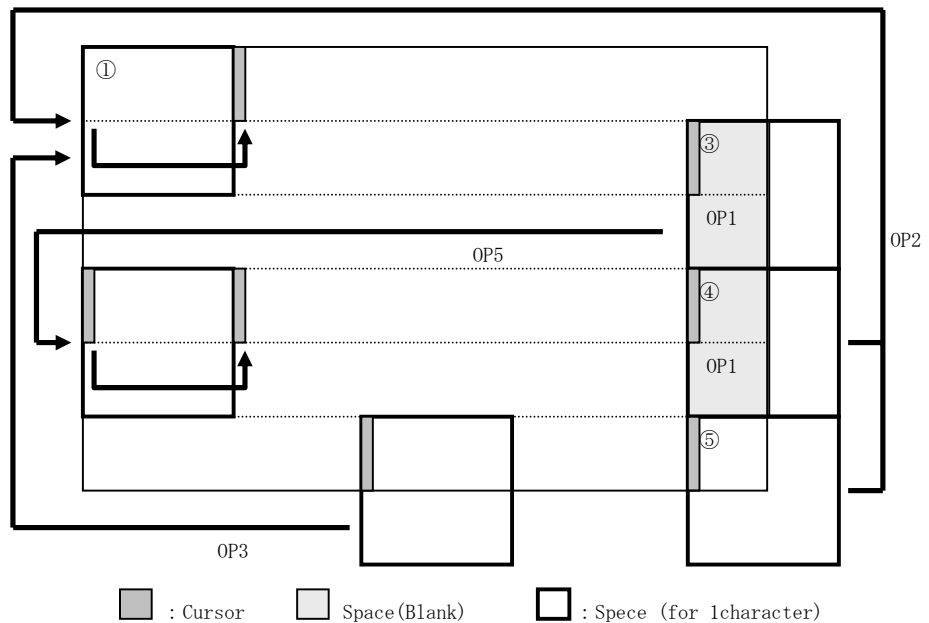

When MD2 (Vertical scroll mode) is selected.

Cursor position		Figure Number	Display Operation
X direction	Y direction		
The space for 1 character size is in right side.	The space for 1 character size in current cursor position.	①	1, Display character on cursor 2, HT execution (OP4)
	No space for 1 character size in current cursor position.	②	1, All of display contents are scrolled up for some number of dots required, and clear the display contents of bottom area 2, The cursor moves to the displayable upper position. (OP3) 3, Display character on cursor 3, HT execution
No space at the right end.	The space for 1 character size is in lower line from current cursor position.	③	1, Display space on cursor(OP1) 2, The cursor moves to the left end of one lower line. (OP2) 3, Display character on cursor 4, HT execution
	No space for 1 character size in lower line from current cursor position.	④	1, Display space on cursor (OP1) 2, All of display contents are scrolled up for some number of dots required, and clear the display contents of bottom area 3, The cursor moves to the left end of bottom line (OP5) 4, Display character on cursor 5, HT execution
	No space for 1 character size in current cursor position.	⑤	1, All of display contents are scrolled up for some number of dots required, and clear the display contents of bottom area 2, The cursor moves to the left end of bottom line (OP5) 3, Display character on cursor 4, HT execution

Note: HT execution is depending on cursor position after displayed. Refer to 3.7.2.3 Horizontal Tab

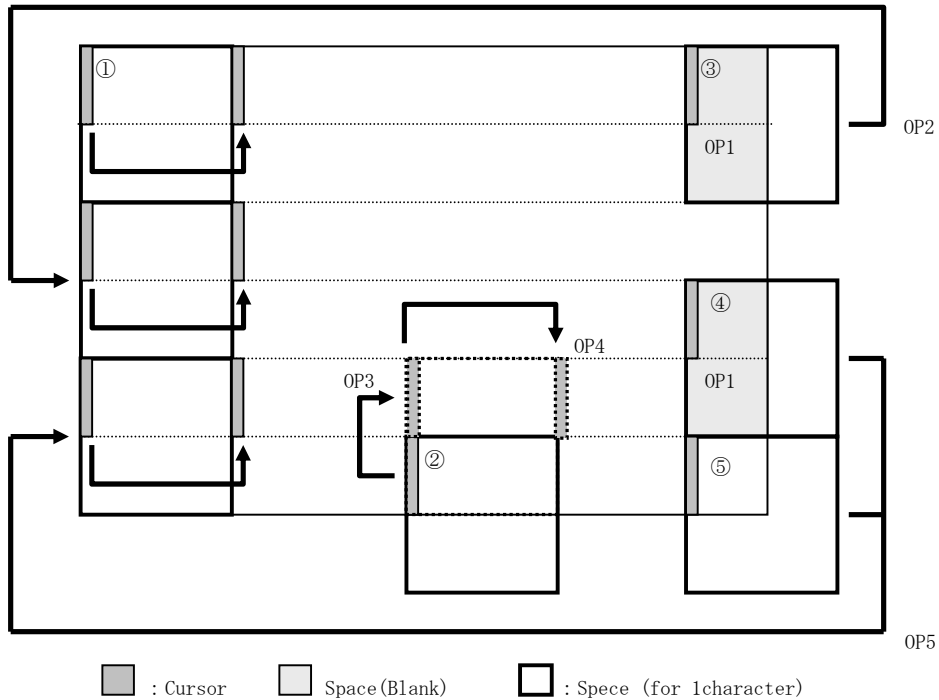

When MD3 (Horizontal scroll mode) is selected.

Cursor position		Y direction	Figure Number	Display Operation
X direction				
The space for 1 character size is in right side.	Not right end	-	①	1, Display character on cursor 2, HT execution (OP2)
	Right end (Refer Figure 2)		-	1, Display character on cursor 2, Shift to Scroll ON*
	-	No space for 1 character size in current cursor position.	②	No action. Cursor does not move.
No space at the right end.	-	-	③	1, The contents on the line of current cursor position will be scrolled to left until the space for 1 character size will be made in right end. (OP3) 2, The cursor moves to the left edge of new space for 1 character. (OP1) 3, Display character on cursor 4, Shift to Scroll ON*
	-	No space for 1 character size in current cursor position.	④	No action. Cursor does not move.

Note: \* The next operation after "Scroll ON" :

- 1, The contents on the line of current cursor position will be scrolled to left until the space for 1 character size will be made in right end.
- 2, Display character on cursor

The condition of "Scroll ON" will be canceled, and return to the previous condition if some command related for cursor moving except Character write or HT command is executed.

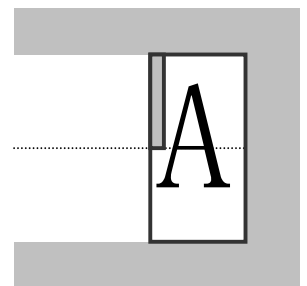
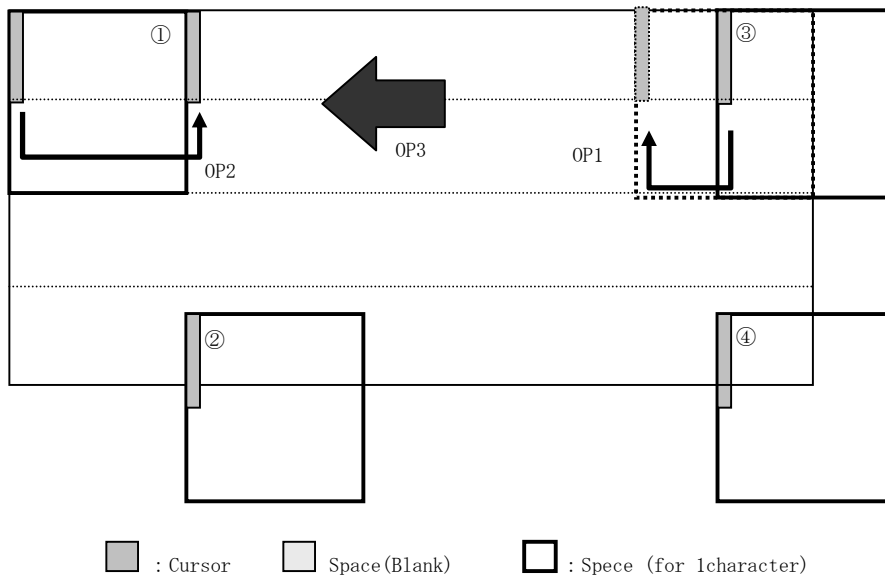

Figure 2

**3.7.2.2 BS (Back Space)****Code: 08H**

Function: The cursor moves to left by one character.

This command effects on the current window selected by "Current window select".

When MD1 (Over-write mode) and MD2 (Vertical scroll mode) is selected.

Cursor position		Display Operation
X direction	Y direction	
The space for 1 character size is in left side.	-	The cursor moves to left by one character.
No space at the left end.	The space for 1 character size is in upper line from current cursor position.	The cursor moves to the right end of one upper line.
	No space for 1 character size is in upper line from current cursor position.	The cursor does not move.

When MD3 (Horizontal scroll mode) is selected.

Cursor position		Display Operation
X direction	Y direction	
The space for 1 character size is in left side.	-	The cursor moves to left by one character.
No space at the left end.	-	The cursor does not move.

**3.7.2.3 HT (Horizontal Tab)****Code: 09H**

Function: The cursor moves to right by one character. This command effects on the current window selected by "Current window select".

The detail of operation is:

When MD1 (Over-write mode) is selected.

Cursor position		Display Operation
X direction	Y direction	
The space for 1 character size is in right side.	-	The cursor moves to right by one character.
No space at the right end.	The space for 1 character size is in lower line from current cursor position.	The cursor moves to the left end of one lower line.
	No space for 1 character size is in lower line from current cursor position.	The cursor moves to the left end of top line.

When MD2 (Vertical scroll mode) is selected.

Cursor position		Display Operation
X direction	Y direction	
The space for 1 character size is in right side.	-	The cursor moves to right by one character.
No space at the right end.	The space for 1 character size is in lower line from current cursor position.	The cursor moves to the left end of one lower line.
	No space for 1 character size is in lower line from current cursor position.	1, All displayed pattern is scrolled up for some number of dots required. 2, Displayed pattern of lowest line is cleared. 3, Cursor moves to left end of bottom line.

When MD3 (Horizontal scroll mode) is selected.

Cursor position		Y direction	Display Operation
X direction			
The space for 1 character size is in right side.	Not right end	-	The cursor moves to right by one character.
	Right end (Refer Figure 2)		Shift to Scroll ON*
No space at the right end.	-	-	1, The contents on the line of current cursor position will be scrolled to left until the space for 1 character size will be made in right end. 2, The cursor moves to the left edge of new space for 1 character. 3, Shift to Scroll ON*

Note: \* The next operation after "Scroll ON" :  
The contents on the line of current cursor position will be scrolled to left until the space for 1 character size will be made in right end. (Cursor does not move.)

The condition of "Scroll ON" will be canceled, and return to the previous condition if some command related for cursor moving except Character write or HT command is executed.

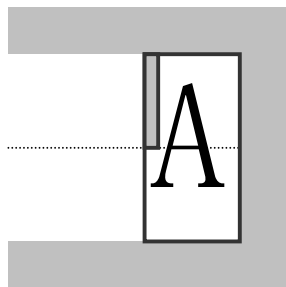

Figure 2

### 3.7.2.4 LF (Line Feed)

Code: 0AH

Function: The cursor moves to one lower line. This command effects on the current window selected by "Current window select".

The detail of operation is as follows;

When MD1 (Over-write mode) is selected.

Cursor position		Display Operation
X direction	Y direction	
-	The space for 1 character size is in lower line from current cursor position.	The cursor moves to the same position of one lower line.
	No space for 1 character size is in lower line from current cursor position.	The cursor moves to the same position of top line.

When MD2 (Vertical scroll mode) is selected.

Cursor position		Display Operation
X direction	Y direction	
-	The space for 1 character size is in lower line from current cursor position.	The cursor moves to the same position of one lower line.
	No space for 1 character size is in lower line from current cursor position.	1, All of displayed pattern is scrolled to one upper line 2, Displayed pattern of bottom line is cleared. The cursor does not move.

When MD3 (Horizontal scroll mode) is selected.

Cursor position		Display Operation
X direction	Y direction	
-	-	The cursor does not move.

### 3.7.2.5 HOM (Home Position)

**Code: 0BH**

Function: The cursor moves to the home position. This command effects on the current window selected by "Current window select".

### 3.7.2.6 CR (Carriage Return)

**Code: 0DH**

Function: The cursor moves to left end of same line. This command effects on the current window selected by "Current window select".

### 3.7.2.7 CLR (Display Clear)

**Code: 0CH**

Function: The display screen is cleared and the cursor moves to home position after this command was executed. This command effects on the current window selected by "Current window select".

### 3.7.3 Command Set

#### 3.7.3.1 General setting commands

Command Name	Hex Code	Operation	Page
Brightness level setting	1FH,58H,n  <b>Default n=04H</b> or depending on Memory SW	Specify brightness level of all display screens. n=00H:0%    n=01H:25%    n=02H:50% n=03H:75%    n=04H:100% n=10H:0%    n=11H:12.5%    n=12H:25% n=13H:37.5%    n=14H:50%    n=15H:62.5% n=16H:75%    n=17H:87.5%    n=18H:100%	P20
Initialize Display	1BH, 40H	Clear the all display screen, and initialize all setting.	P20
Cursor set	1FH,24H,xL,xH,yL,yH	The cursor moves to specified X, Y position on display memory. xL: Cursor position x lower byte. xH: Cursor position x upper byte. yL: Cursor position y lower byte. yH: Cursor position y upper byte.	P20
Cursor display ON/OFF select	1FH,43H,n <b>Default n=00H</b>	Display cursor ON/OFF select n=00H: Cursor OFF n=01H: Cursor ON	P20

#### 3.7.3.2 Character display setting commands

Command Name	Hex Code	Operation	Page
Write screen mode select	1FH,28H,77H,10H, a <b>Default n=00H</b> or depending on Memory SW	Select the write screen mode for base window. a=00H: Display screen mode a=01H: All screen mode	P21
Specifies International font set	1BH,52H,n  <b>Default n=00H</b> or depending on Memory SW	Some characters located on 20h-7Fh are chosen/replaced from 14 types font set. n=00H:America    n=01H:France n=02H:Germany    n=03H:England n=04H:Denmark 1    n=05H:Sweden n=06H:Italy    n=07H:Spain1 n=08H:Japan    n=09H:Norway n=0AH:Denmark2    n=0BH:Spain2 n=0CH:Latin America    n=0DH:Korean	P21
Specifies Character code type (Specify Extended font table)	1BH,74H,n  <b>Default n=00H</b> or depending on Memory SW	The fonts located on 80h-FFh of font table are chosen/Replaced from 10 types font set. n=00H:PC437 (USA:Standard Europe) n=01H:Katakana,n=02H:PC850 (Multilingual) n=03H:PC860 (Portuguese) n=04H:PC863 (Canadian-French) n=05H:PC865 (Nordic),n=10H:WPC1252 n=11H:PC866 (Cyrillic #2) n=12H:PC852 (Latin 2), n=13H:PC858 n=FFH: User table	P22
Over-write mode	1FH, 01H	Set to Over-write mode.	P22
Vertical scroll mode	1FH, 02H	Set to Vertical scroll mode.	P22
Horizontal scroll mode	1FH, 03H	Set to horizontal scroll mode.	P22
Horizontal scroll speed	1FH,73H,n <b>Default n=00H</b> or depending on Memory SW	Set to horizontal scroll speed.	P22
Font size select	1FH,28H,67H,01H, m <b>Default m=01H</b> or depending on Memory SW	Select font size of a character. m= 01H: 6x8 font m= 02H: 8x16 font m= 04H: 16x32 font	P23
Specify-Cancel 2byte character mode	1FH,28H,67H,02H, m <b>Default m=00H</b> or depending on Memory SW	Specify or cancel 2byte character mode. m=01H: Specify 2byte character mode m=00H: Cancel 2byte character moder	P23



Command Name	Hex Code	Operation	Page
Select 2byte character type	1FH,28H,67H,03H, m <b>Default m=00H</b> or depending on Memory SW	Select 2 byte character type m=00H: Japanese m=01H: Korean m=02H: Simplified Chinese m=03H: Traditional Chinese	P23
Font magnified display	1FH,28H,67H,40H ,x,y <b>Default x=01H,y=01H</b> or depending on Memory SW	Magnify the character by x times on the right, y times downward. x: Specify the size of magnification X y: Specify the size of magnification Y	P23
Character bold display	1FH,28H,67H,41H, b <b>Default b=00H</b> or depending on Memory SW	Specify or cancel boldface character. b = 00H: Cancels Bold b = 01H: Specify Bold	P24

### 3.7.3.3 Display action setting commands

Command Name	Hex Code	Operation	Page
Wait	1FH,28H,61H,01H, t	Data processing are stopped while waiting by this command. t: Wait time (x approx. 0.5sec)	P24
Short Wait	1FH,28H,61H,02H, t	Data processing are stopped while waiting by this command. t: Wait time (x approx.14msec)	P24
Scroll display action	1FH,28H,61H,10H ,wL,wH,cL,cH,s	Shift the display screen. Horizontal display screen scrolling can be possible by this command. wL: Number of Display screen shift lower byte. wH: Number of Display screen shift upper byte. cL: Number of repetition lower byte cH: Number of repetition upper byte s: Scroll speed	P24
Display Blink	1FH,28H,61H,11H, p,t1,t2,c	Blink display action on display screen. p: Blink pattern t1: Normal display time t2: Blank or Reverse display time c: Number of repetition	P25
Curtain display action	1FH,28H,61H,12H, v,s,p	Curtain display action on display screen. v: Direction of Curtain action s: Curtain action speed p: Curtain action pattern	P26
Spring display action	1FH,28H,61H,13H, v,s,pL,pH	Spring display action on display screen. v: Direction of spring action s: Spring action speed pL: Display memory pattern address lower byte pH: Display memory pattern address upper byte	P26
Random display action	1FH,28H,61H,14H, s,pL,pH	Random display action on display screen. s: Random display action speed pL: Display memory pattern address lower byte pH: Display memory pattern address upper byte	P27
Display power ON/OFF (Display power ON/OFF control)	1FH,28H,61H,40H, p <b>Default p=01H</b>	Set the display power ON or OFF. p=01H: ON, p=00H: OFF	P28

### 3.7.3.4 Bit image display setting commands

Command Name	Hex Code	Operation	Page
Dot pattern drawing	1FH,28H,64H,10H ,pen,xL,xH,yL,yH	Display the dot pattern on a drawing position or delete the dot pattern already displayed. pen:Dot display ON or OFF xL: Dot pattern drawing position x,lower byte xH: Dot pattern drawing position x,upper byte yL: Dot pattern drawing position y,lower byte yH: Dot pattern drawing position y,upper byte	P28

Command Name	Hex Code	Operation	Page
Line/Box pattern drawing	1FH,28H,64H,11H ,mode,pen,x1L, x1H,y1L,y1H,x2L, x2H,y2L,y2H	Display the Line, Box, Box FILL on the drawing area specified by x1,y1,x2,y2 or delete the dot pattern already displayed. mode: Drawing mode select pen: Dot ON or OFF x1L: Line/Box pattern drawing start position x1,lower byte x1H: Line/Box pattern drawing start position x1,upper byte y1L: Line/Box pattern drawing start position y1,lower byte y1H: Line/Box pattern drawing start position y1,upper byte x2L: Line/Box pattern drawing end position x2,lower byte x2H: Line/Box pattern drawing end position x2,upper byte y2L: Line/Box pattern drawing end position y2,lower byte y2H: Line/Box pattern drawing end position y2,upper byte	P28
Real-time bit image display	1FH,28H,66H,11H ,xL,xH,yL,yH,01H ,d(1)...d(S)	Display the bit image data on the cursor position real-time. xL: Bit image X size lower byte ( by 1dot) xH: Bit image X size upper byte ( by 1dot) yL: Bit image Y size lower byte ( by 8dots) yH: Bit image Y size upper byte ( by 8dots) d(1)...d(s): Image data	P29
RAM bit image definition	1FH,28H,66H,01H, aL,aH,aE,sL,sH,sE ,d(1)...d(s)	Define user bit image to the RAM. aL: Bit image data definition address lower byte aH: Bit image data definition address upper byte aE: Bit image data definition address extension byte sL: Bit image data length lower byte sH: Bit image data length upper byte sE: Bit image data length extension byte d(1)...d(s):Image data	P30
FROM bit image definition *Valid at the user setup mode.	1FH,28H,65H,10H, aL,aH,aE,sL,sH,sE ,d(1)...d(s)	Define user bit image to the FROM. aL: Bit image data definition address lower byte aH: Bit image data definition address upper byte aE: Bit image data definition address extension byte sL: Bit image data length lower byte sH: Bit image data length upper byte sE: Bit image data length extension byte d(1)...d(s):Image data	P31
Downloaded bit image display	1FH,28H,66H,10H, m,aL,aH,aE,ySL,y SH,xL,xH,yL,yH,01 H	Display the RAM or FROM bit image defined on cursor position. m: Select bit image data display memory aL: Bit image data definition address lower byte aH: Bit image data definition address upper byte aE: Bit image data definition address extension byte ySL: Bit image defined, Y size lower byte (by 8dots) ySH: Bit image defined, Y size upper byte (by 8dots) xL: Bit image display X size lower byte (by 1dot) xH: Bit image display X size upper byte (by 1dot) yL: Bit image display Y size lower byte (by 8dots) yH: Bit image display Y size upper byte (by 8dots)	P33
Downloaded bit image scroll display	1FH,28H,66H,90H, m,aL,aH,aE,ySL,y SH,xL,xH,yL,yH,01 H,s	Scroll display the RAM, FROM or Display memory bit image defined from the right end of current window. m: Select bit image data display memory aL: Bit image data definition address lower byte aH: Bit image data definition address upper byte aE: Bit image data definition address extension byte ySL: Bit image defined, Y size lower byte (by 8dots) ySH: Bit image defined, Y size upper byte (by 8dots) xL: Bit image scroll display shift X size lower byte (by 1dot) xH: Bit image scroll display shift X size upper byte (by 1dot) yL: Bit image scroll display Y size lower byte (by 8dots) yH: Bit image scroll display Y size upper byte (by 8dots) s:Scroll speed	P35

**3.7.3.5 General display setting commands**

Command Name	Hex Code	Operation	Page
Horizontal scroll quality select	1FH,60H,n <b>Default n=00H</b> or depending on Memory SW	Select the visual quality of horizontal scroll n=00H: Scroll speed-priority n=01H: Visual quality-priority	P37
Specifies or cancels reverse display	1FH,72H,n <b>Default n=00H</b> or depending on Memory SW	Specifies or cancels reverse display n=00H: Cancel reverse mode n=01H: Specify reverse mode	P37
Specifies write mixture display mode	1FH,77H,n <b>Default n=00H</b> or depending on Memory SW	Specifies write mixture mode. The new character or graphic image display mixed with current display image stored in display memory is overwritten to the display memory. n=00H: Normal display write. (Not mixture display) n=01H: OR display write, n=02H: AND display write n=03H: EX-OR display write	P37

**3.7.3.6 Window display setting commands**

Command Name	Hex Code	Operation	Page
Current window select	1FH,28H,77H,01H, a	Select current window a=00H:Base window, a=01H:User window1 a=02H: User window2, a=03H: User window3 a=04H: User window4	P37
User Window definition-cancel	1FH,28H,77H,02H, a,b,xPL,xPH,yPL ,yPH,xSL,xSH,ySL ,ySH	Define or Cancel User Window a: Definable window No. b:Define or Cancel xPL: Left position of window lower byte ( by 1dot) xPH: Left position of window upper byte ( by 1dot) yPL: Top position of window lower byte ( by 8dot) yPH: Top position of window upper byte ( by 8dot) xSL: X size of window lower byte ( by 1dot) xSH: X size of window upper byte ( by 1dot) ySL: Y size of window lower byte ( by 8dot) ySH: Y size of window upper byte ( by 8dot)	P38

**3.7.3.7 Download character setting commands**

Command Name	Hex Code	Operation	Page
Specify Download character	1BH,25H,n <b>Default n=00H</b>	Specify enable or disable for download character n=01H: Enable, n=00H: Disable	P39
Download character definition	1BH,26H,a,c1,c2 ,x1,d1...dx1,xk ,d1...dxk	Define 6 x 8 or 8 x 16 dot download characters into RAM. a: Select character type c1: Start character code c2: End character code x: Number of dot for X direction d1...dxk: Defined data	P39
Delete downloaded character	1BH,3FH,a,c	Delete defined 6x8 or 8x16 dot download character. a: Select character type c: Character code for delete	P39
16x16 Download character definition	1FH,28H,67H,10H ,c1,c2,d1...dk	Defines the16 x 16 downloaded character in specified code. c1 : Character code upper byte c2 : Character code lower byte d : Definition data	P40
16x16 downloaded character Delete	1FH,28H,67H,11H ,c1,c2	Delete the16 x 16 downloaded character defined in the specified code. c1 : Delete character code upper byte c2 : Delete character code lower byte	P40
Save downloaded character  *Valid at the user setup mode.	1FH,28H,65H,11H, a	Save the download character already defined on RAM to the FROM. a: Select font type a=01H:6x8 dot, a=02H:8x16dot, a=03H:16x16dot	P40
Download character transfer	1FH,28H,65H,21H, a	Transfer the download character defined in FROM to RAM. a: Select font type a=01H:6x8 dot, a=02H:8x16dot, a=03H:16x16dot	P41
FROM user font definition  *Valid at the user setup mode.	1Fh,28h,65h,13h, m,P(80h-1),P(80h- 2),-P(FFh-n)	Define the user font of 1byte code to the user table. m: User table m=01H:6x8 dot,02H:8x16dot,04H:16x32dot p: Definition data	P41

**3.7.3.8 User setup mode setting commands**

Command Name	Hex Code	Operation	Page
User set up mode start	1FH,28H,65H,01H ,49H,4EH	Start User set up mode start.	P41
User set up mode end *Valid at the user setup mode.	1FH,28H,65H,02H ,4FH,55H,54H	End User set up mode end.	P41

**3.7.3.9 General purpose I/O Port control commands**

Command Name	Hex Code	Operation	Page
I/O Port Input/Output setting	1FH,28H,70H,01H, n,a	Set input or output for general purpose I/O port. n:I/O port number a:Set Input or Output n=00H:Port0, n=01H:Port1 a=00H:Input, a=01H:Output	P42
I/O Port Output	1FH,28H,70H,10H, n,a	Output the data to general purpose I/O port.	P42
I/O Port Input	1FH,28H,70H,20H, n	The state of a general purpose I/O port is transmitted via RS232C I/F.	P42

**3.7.3.10 Macro setting commands**

Command Name	Hex Code	Operation	Page
RAM Macro processing definition	1FH,3AH,pL,pH ,d1...dk	Define or delete of RAM Macro processing definition. pL: RAM Macro data length lower byte pH: RAM Macro data length upper byte d1...dk: RAM Macro data	P42
FROM Macro processing definition *Valid at the user setup mode.	1FH,28H,65H,12H, a,pL,pH,t1,t2,d(1) ...d(p)	Define or delete FROM Macro to the FROM a: FROM Macro definition number pL: FROM Macro data length lower byte pH: FROM Macro data length upper byte t1: Display time interval t2: Idle time of macro repetition d(1)...d(P): FROM Macro data	P43
Macro execution	1FH,5EH,a,t1,t2	Execute Macro continuously. a: Macro processing definition number a=00H: RAM Macro 0 a=01H~04H: FROM Macro 1 - 4 a=80H:RAM Program Macro a=81H~84H : FROM Program Macro 1~4 t1: Display time interval t2: Idle time of macro repetition	P43

**3.7.3.11 Other setting commands**

Command Name	Hex Code	Operation	Page
Memory SW setting *Valid at the user setup mode.	1FH,28H,65H,03H, a,b	Set the contents of data"b" to memory SW "a". a: Memory SW number b:Setting data	P44
Memory SW data send	1FH,28H,65H,04H, a	Send the contents of memory SW data "a". a:Memory SW number	P44
Display status send	1FH,28H,65H,40H, a,b,c	Send each display status information.. a:Informarion name a=01H: Boot version information a=02H: Firmware version information a=10H: Kanji font information a=20H: Memory check sum information a=30H: Product information a=40H: Display x dot information a=41H: Display y dot information b: Start address c: Data length	P44
Memory re-write mode shift	1CH,7CH,4DH, D0H,4DH,4FH,44H ,45H,49H,4EH	Shift to "Memory re-write mode" from "Normal mode".	P45

### 3.7.4 Detail of Command Set

#### 3.7.4.1 US X n (Brightness level setting)

**Code:** 1FH 58H n

n : Brightness level setting

Definable area: 00H  $\leq$  n  $\leq$  04H , 10H  $\leq$  n  $\leq$  18H

Default: n=04H or depending on Memory SW.

Function: Specify brightness level of whole display screen.

n: Level

n	Brightness level	n	Brightness level
00H	0%	12H	25%
01H	25%	13H	37.5%
02H	50%	14H	50%
03H	75%	15H	62.5%
04H	100%	16H	75%
10H	0%	17H	87.5%
11H	12.5%	18H	100%

#### 3.7.4.2 ESC@ (Initialize Display)

**Code:** 1BH 40H

Returns to default.

DIP Switch is not re-loaded.

The contents of receiving buffer remain in memory.

#### 3.7.4.3 US \$ x y (Cursor Set)

**Code:** 1FH 24H xL xH yL yH

xL: Cursor position x Lower byte (1 dot/unit)

xH: Cursor position x Upper byte (1 dot/unit)

yL: Cursor position y Lower byte (8 dot/unit)

yH: Cursor position y Upper byte(8 dot/unit)

Definable area: 0000H  $\leq$  ( xL + xH x 100H )  $\leq$  03FFH

0000H  $\leq$  ( yL + yH x 100H )  $\leq$  0003H

Function: The cursor moves to specified X, Y position on display memory. If the specified X, Y position (X, Y, either or both) is over range, the command is ignored, and keeps same cursor position.

This command effects on the current window selected by "Current window select".

#### 3.7.4.4 US ( d n (Cursor display ON/OFF select)

**Code:** 1FH 43H n

n: Display cursor ON/OFF select

Definable area: 00H  $\leq$  n  $\leq$  01H

n = 00H : Cursor display OFF

n = 01H : Cursor display ON

Default: n = 00H, Cursor OFF

Function: Select Cursor display ON or OFF.

When cursor display ON is selected, the cursor position is displayed by reverse/blink of 1x8 dots. When cursor is in hidden display area, it is not displayed by the cursor display ON, either.

This command effects on the current window selected by "Current window select" .

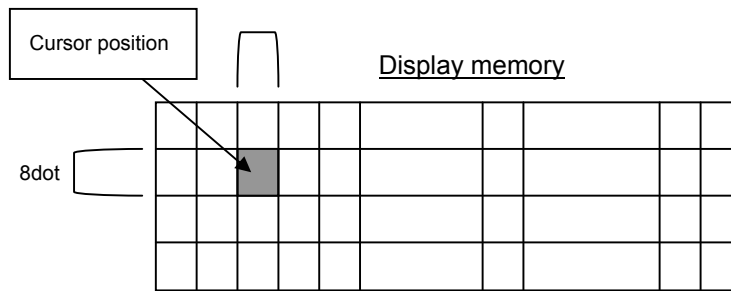

**3.7.4.5 US ( w n a (Write screen mode select )**

**Code: 1FH 28H 77H n a**

n: Classify command  
 a: Write screen mode  
 a = 0: Display screen mode  
 a = 1: All screen mode

Definable area: n = 10H  
 $00H \leq a \leq 01H$

Default: a= 00H or depending on Memory SW.

Function: Select the write screen mode  
 Select "Display screen mode":  
 Display action is valid within area of either display screen or non-display screen depending on cursor position.  
 Select "All screen mode": Display action is valid on all of screen area.

**3.7.4.6 ESC R n (Specifies International font set)**

**Code: 1BH 52H n**

Definable area:  $00H \leq n \leq 0DH$   
 Default: n=00H or depend on Memory SW.  
 Function: Select international font set.

Does not affect to the character already displayed.

n	Font set
00H	America
01H	France
02H	Germany
03H	England
04H	Denmark 1
05H	Sweden
06H	Italy
07H	Spain1
08H	Japan
09H	Norway
0AH	Denmark2
0BH	Spain2
0CH	Latin America
0DH	Korea

**3.7.4.7 ESC t n (Specifies character code type)**

**Code:** 1BH 74H n  
 Definable area: n = 00H, 01H, 02H, 03H, 04H, 05H, 10H 11H, 12H, 13H  
 Default: n = 0 or depending on Memory SW.  
 Function: Selects font code

Does not affect to the character already displayed.  
 FFH (User table): User table is an original font table which the user font was defined by the FROM user font definition command.

n	Font code type
00H	PC437(USA – Euro std)
01H	Katakana – Japanese
02H	PC850 (Multilingual)
03H	PC860 (Portuguese)
04H	PC863 (Canadian-French)
05H	PC865 (Nordic)
10H	WPC1252
11H	PC866 (Cyrillic #2)
12H	PC852 (Latin 2)
13H	PC858
FFH	User table

**3.7.4.8 US MD1 (Over-write mode)**

**Code:** 1FH 01H  
 Function: Over-writes, or replaces existing data.  
 This command effects on the current window selected by "Current window select" .

**3.7.4.9 US MD2 (Vertical scroll mode)**

**Code:** 1FH 02H  
 Function: Enables vertical scrolling of current window.  
 Scrolling occurs only after window space has been exceeded.  
 This command effects on the current window selected by "Current window select" .

**3.7.4.10 US MD3 (Horizontal scroll mode)**

**Code:** 1FH 03H  
 Function: Enables horizontal scrolling of current window.  
 Scrolling occurs only after window space has been exceeded. Amount scrolled depends on value set in "Horizontal scroll speed".  
 This command effects on the current window selected by "Current window select" .

**3.7.4.11 US s n (Horizontal scroll speed)**

**Code:** 1FH 73H n  
 Definable area:  $00 \leq n \leq 1FH$   
 Default: n = 00H or depending on Memory SW.

If n=0 is specified, scrolling is appeared by character n	Speed
00H	By Character
01H	T msec / dots
02H – 1FH	$(n-1) \times T$ msec / dot

Note that until scrolling action is ended, new command(s) will not executed. Scroll base speed "T" is depending on write screen mode, character size selected.

Attention: "Scroll speed T" is an approximate value. It may become sometime slow down or may flicker depending on scroll size. **Scroll speed-priority or Visual quality-priority can be selected as scroll display condition. Refer to "3.7.4.32 Horizontal scroll display quality select"**.

**3.7.4.12 US ( g n m (Font size select)****Code:** 1FH 28H 67H 01H mDefinable area: n = 01H  
m = 01H, 02H, 04H

Default: m = 01H or depending on Memory SW.

Function: Select the font size of 1 byte code character (ANK, download character)

m	Function
01H	6x8dot character
02H	8x16 dot character
04H	16x32 dot character

**3.7.4.13 US ( g n m (Specify-Cancel 2byte character mode)****Code:** 1FH 28H 67 02H mDefinable area: n = 02H  
m = 00H, 01H

Default: m = 00H or depending on Memory SW.

Function: Specify or cancel 2byte character mode

m	Function
00H	Cancel 2byte character mode
01H	Specify 2byte character mode

**3.7.4.14 US ( g n m (Select 2byte character type)****Code:** 1FH 28H 67 03H mDefinable area: n = 03H  
m = 00H, 01H, 02H, 03H

Default: m = 00H or depending on Memory SW.

Function: Select 2byte character type.

m	Function	Code type
00H	Japanese	JIS X0208 (Shift-JIS)
01H	Korean	KSC5601-87
02H	Simplified Chinese	GB2312-80
03H	Traditional Chinese	Big-5

**In case of display 16x16, 2byte character font:**Font size select: Code: 1FH 28H 67H 01H **02H**Specify-Cancel 2byte character mode: Code: 1FH 28H 67H 02H **01H**Select 2byte character type: Code: 1Fh 28h 67h 03h 00h Japanese  
1Fh 28h 67h 03h 01h Korean  
1Fh 28h 67h 03h 02h Simplified Chinese  
1Fh 28h 67h 03h 03h Traditional Chinese

2 byte character code input: Code 88H 9FH ("亜" Exaple of Japanese)

**3.7.4.15 US ( g n x y (Font magnified display)****Code:** 1FH 28H 67H 40H x y

n: Classify command

x: Specify the size of magnification X

y: Specify the size of magnification Y

Definable area: n = 40H  
01H ≤ x ≤ 04H  
01H ≤ y ≤ 02H

Default: x = 01H or depending on Memory SW.

y = 01H or depending on Memory SW.

Function: Magnify the character by x times on the right, y times downward.

Character is magnified including the space specified by Character display width command.



**3.7.4.16 US ( g n b (Character bold display)**

**Code:** 1FH 28H 67H 41H b  
 n: Classify command  
 b: Bold  
 Definable area: n = 41H  
 $00H \leq b \leq 01H$   
 b = 00H: cancels Bold / b = 01H: specifies Bold  
 Default: b= 00H or depending on Memory SW.  
 Function: Specifies or cancels boldface character (*Boldface may reduce legibility*)

**3.7.4.17 US ( a n t (Wait)**

**Code:** 1FH 28H 61H 01H t  
 n: Classify command  
 t: Wait time  
 Definable area: n = 01H  
 $00H \leq t \leq FFH$   
 Note: Wait time, this stops definition, command, and data processing while waiting  
 Wait time = t X approx. 0.5sec  
 Command/data is not performed until processing is completed.  
 Please define and execute a Macro that command is defined to be interrupted during processing.

**3.7.4.18 US ( a n t (Short Wait)**

**Code:** 1FH 28H 61H 02H t  
 n: Classify command  
 t: Wait time  
 Definable area: n = 02H  
 $00H \leq t \leq FFH$   
 Note: Wait time, this stops definition, command, and data processing while waiting  
 Wait time = t X approx. 14msec  
 Command/data is not performed until processing is completed.  
 Please define and execute a Macro that command is defined to be interrupted during processing.

**3.7.4.19 US ( a n wL wH cL cH s (Scroll display action)**

**Code:** 1FH 28H 61H 10H wL wH cL cH s  
 n : Classify command  
 wL: Display screen shift, number of lower byte.  
 wH: Display screen shift, number of upper byte.  
 cL: Number of repetition lower byte  
 cH: Number of repetition upper byte  
 s: Scroll action speed  
 Definable area: n = 10H  
 $0000H \leq (wL + wH \times 100H) \leq 0FFFFH$   
 $0001H \leq (cL + cH \times 100H) \leq FFFFH$   
 $00H \leq s \leq FFH$   
 Function: Shift the display screen.  
 Horizontal scrolling can be possible by specifying the shift byte to multiple number of (Display screen "y" dot /8). Display switching can be possible by specify shift byte to (Display screen "x" dot x Display screen "y" dot /8). Scroll speed is specified by "s".  
 Scroll speed: s X approx. 14msec/1 shift  
 Command/data is not performed until processing is completed. Please define and execute a Macro that command is defined to be interrupted during processing.

For example: 1dot scroll to the left: wL=04H, wH=00H

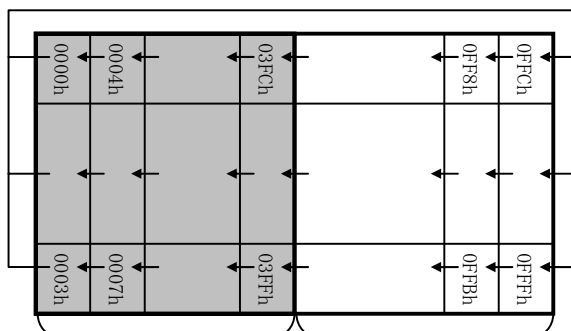

Display area 256dots Hdden area 768dots

### 3.7.4.20 US ( a n p t1 t2 c (Display Blink)

Code: 1FH 28H 61H 11H p t1 t2 c

- n: Classify command
- p: Blink pattern
- t1: Normal display time
- t2: Blank or reverse display time
- c: Number of repetition

Definable area: n = 11H

00H ≤ p ≤ 02H

p=00H: Normal display.

p=01H: Repeat blink display with Normal and Blank display

p=02H: Repeat blink display with Normal and Reverse display

01H ≤ t1 ≤ FFH

01H ≤ t2 ≤ FFH

00H ≤ c ≤ FFH

Function: Blink display action Blink pattern specified by "p".

Time specified by "t1", "t2", and repeat Blink display

A: t1 X approx.14msec Normal display

B: t2 X approx. 14msec Blank or Reverse display

This command does not affect to display memory.

If c=00H is specified, brink display is repeated until when c=01H - FFH or Initialize command is specified, and the command/data execution is continued during display blinking.

If c=01H – FFH is specified, brink display is repeated 1-255 times, and the command/data execution is stopped. After display blinking is ended, return to Normal display and command/data execution is re-started.

Command/data is not performed until processing is completed.

If it is necessary to cancel the display action command during processing, please define display action command to Macro, and execute it.

**3.7.4.21 US ( a n v s p (Curtain display action)**

**Code: 1FH 28H 61H 12H v s p**

- n: Classify command
- v: Direction of Curtain action
- s: Curtain action speed
- p: Curtain action pattern

Definable area: n = 12H

$00H \leq v \leq 03H$

v=00H: To the Right from the Left edge

v=01H: To the Left from the Right edge.

v=02H: To the Left and Right separately from the Center.

v=03H: To the Center from Left edge and Right edge.

$00H \leq s \leq FFH$

$00H \leq p \leq FFH$

Function: Curtain display action on display screen

Curtain action pattern "p" is displayed from the direction specified by "v"

Curtain action speed is:

Curtain action speed =  $256 / 16 \times a \times X$  approx. 14msec

This command is effective for the display area only, not the non-display area.

Command/data is not performed until processing is completed.

If it is necessary to cancel the display action command during processing, please define display action command to Macro, and execute it.

Examples:

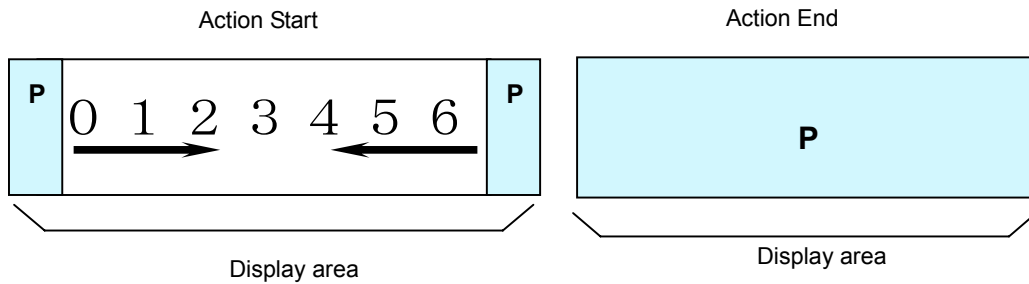

**3.7.4.22 US ( a n v s pL pH (Spring display action)**

**Code: 1FH 28H 61H 13H v s pL pH**

- n: Classify command
- v: Direction of spring action
- s: Spring action speed
- pL: Display memory pattern address lower byte
- pH: Display memory pattern address upper byte

Definable area: n = 13H

$00H \leq v \leq 03H$

v=00H: To the Right from the Left edge.

v=01H: To the Left from the Right edge.

v=02H: To the Left and Right separately from the Center.

v=03H: To the Center from Left edge and Right edge.

$00H \leq s \leq FFH$

$0000H \leq (pL + pH \times 100H) \leq 0FFFH$

Function: Spring display action on display screen.

Pattern "p" specified by display memory pattern address is displayed from the direction specified by "v".

Spring action speed is as follows;

Spring action speed =  $256 / 16 \times a \times X$  approx. 14msec

This command effects only display area, not hidden areas.

Command/data is not performed until processing is completed.

If it is necessary to cancel the display action command during processing, please define display action command to Macro, and execute it.

Example;

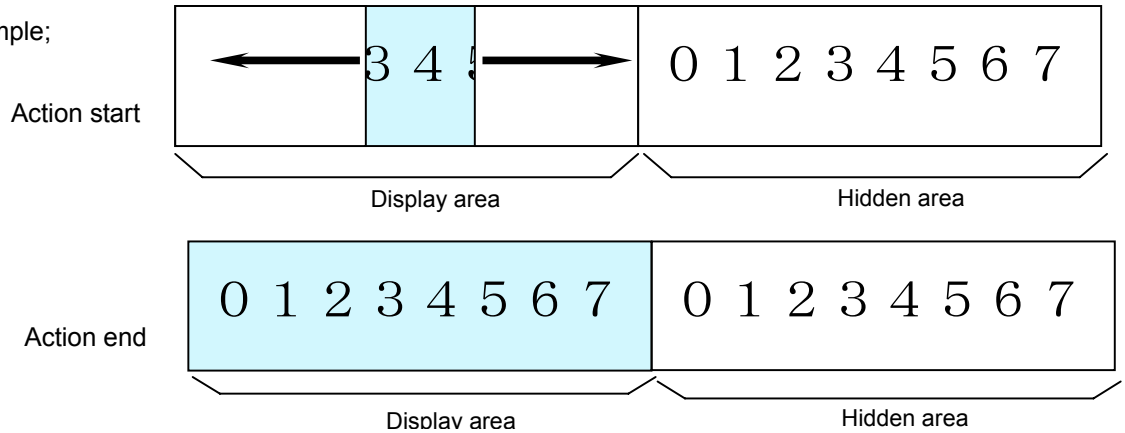

### 3.7.4.23 US ( a n s pL pH (Random display action)

Code: 1FH 28H 61H 14H s pL pH

n: Classify command

s: Random display action speed

pL: Display memory pattern address lower byte

pH: Display memory pattern address upper byte

Definable area: n = 14H

$00H \leq s \leq FFH$

$0000H \leq (pL + pH \times 100H) \leq 0FFFFH$

Function: Random display action on display screen.

Pattern "p" specified by display memory pattern address is displayed randomly.

Random display action is ended by 8 steps, at approx. 56msec / step

This command effects only display area, not for non-display area.

Command/data is not performed until processing is completed.

If it is necessary to cancel the display action command during processing, please define display action command to Macro, and execute it.

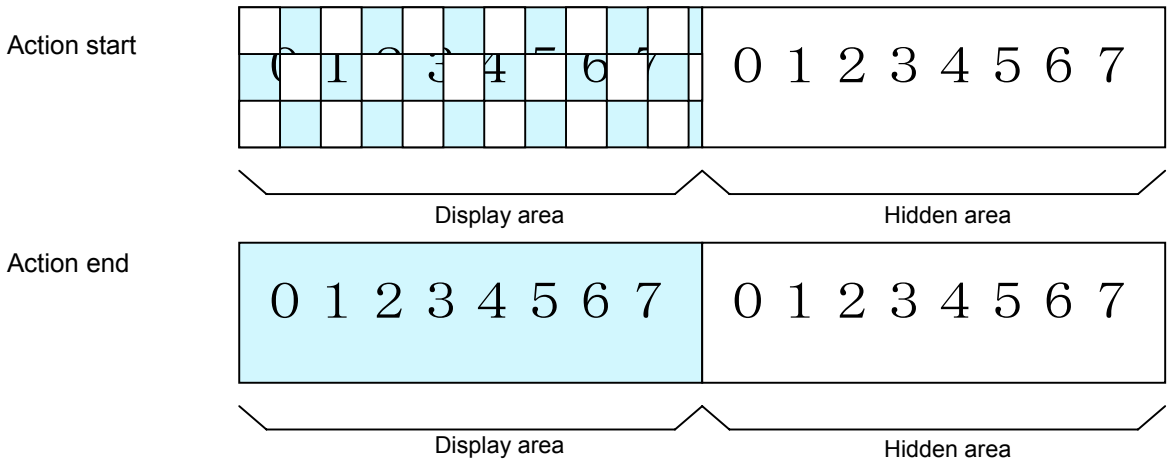

**3.7.4.24 US ( a n p (Display power ON/OFF)****Code: 1FH 28H 61H 40H p**

n: Classify command

p: Select Display power ON/OFF

Definable area: n = 40H

 $00H \leq p \leq 01H$ 

p=00H: Power OFF (All dot OFF, Power save mode)

p=01H: Power ON (All dot ON)

Default: p= 01H

Function: Control Display power ON or OFF,

This is applied until next Display power ON/OFF command, Initialize, or Power OFF is executed.

**3.7.4.25 US ( d n pen xL xH yL yH (Dot pattern drawing)****Code: 1FH 28H 64H 10H pen xL xH yL yH**

n: Classify command

pen: Dot Display ON or OFF

xL: Dot pattern drawing position x, lower byte

xH: Dot pattern drawing position x, upper byte

yL: Dot pattern drawing position y, lower byte

yH: Dot pattern drawing position y, upper byte

Definable area: n = 10H

 $00H \leq pen \leq 01H$ 

pen = 00H: Dot Display OFF, pen = 01H: Dot Display ON

 $0000H \leq (xL + xH \times 100H) \leq 03FFH$  $0000H \leq (yL + yH \times 100H) \leq 001FH$ 

Function: Display the dot pattern on a drawing position specified, or deletes the dot pattern already displayed.

This command effects on the current window selected by "Current window select".

If Display ON/OFF select and Dot pattern drawing position are overflow from definable area, the command is cancelled, and the following data is executed as standard data.

**3.7.4.26 US ( d n mode pen x1L x1H y1L y1H x2L x2H y2L y2H (Line/Box pattern drawing)****Code: 1FH 28H 64H 11H mode pen x1L x1H y1L y1H x2L x2H y2L y2H**

n: Classify command

mode: Drawing mode select, Line, Box, Box FILL

pen: Line/Box Display ON or OFF

x1L: Line/Box pattern drawing start position x1, lower byte

x1H: Line/Box pattern drawing start position x1, upper byte

y1L: Line/Box pattern drawing start position y1, lower byte

y1H: Line/Box pattern drawing start position y1, upper byte

x2L: Line/Box pattern drawing end position x2, lower byte

x2H: Line/Box pattern drawing end position x2, upper byte

y2L: Line/Box pattern drawing end position y2, lower byte

y2H: Line/Box pattern drawing end position y2, upper byte

Definable area: n = 11H

 $00H \leq mode \leq 02H$ 

mode = 00H :Line

mode = 01H :Box

mode = 02H :Box FILL

 $00H \leq pen \leq 01H$ pen = 00H : **Line/Box** Display OFF, pen = 01H : **Line/Box** Display ON $0000H \leq (x1L + x1H \times 100H) \leq 03FFH$  $0000H \leq (y1L + y1H \times 100H) \leq 001FH$  $0000H \leq (x2L + x2H \times 100H) \leq 03FFH$

$0000H \leq (y2L + y2H \times 100H) \leq 001FH$

Function: Display the Line, Box, Box FILL on the drawing area specified by x1,y1,x2,y2 or delete the dot pattern already displayed.

This command effects on the current window selected by "Current window select" .  
 If Display ON/OFF select and Dot pattern drawing position are overflow from definable area, the command is cancelled, and the following data is executed as standard data.  
 When a slanting line is drawn by line command, it may be partially drawn by width of 2 or more dots.

Drawing mode

Line Drawing

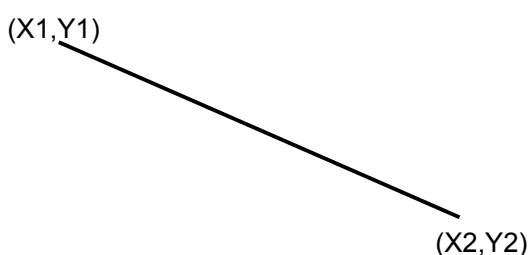

Box Drawing

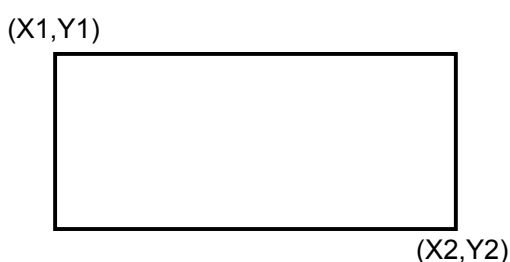

Box FILL Drawing

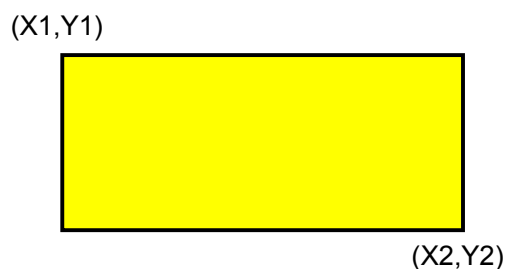

### 3.7.4.27 US ( f n xL xH yL yH g d(1)...d(k) (Real-time bit image display)

Code: 1FH 28H 66H 11H xL xH yL yH g d(1)...d(k)

n: Classify command  
 xL: Bit image X size lower byte ( by 1dot)  
 xH: Bit image X size upper byte ( by 1dot)  
 yL: Bit image Y size lower byte ( by 8dots)  
 yH: Bit image Y size upper byte ( by 8dots)  
 g: Image =1(Fixed)  
 d(1) - d(k): Image data (Refer to figure as follows)

Definable area: n = 11H  
 $0001H \leq (xL + xH \times 100H) \leq 0400H$   
 $0001H \leq (yL + yH \times 100H) \leq 0004H$   
 g= 01H  
 k = x X y X g  
 $00H \leq d \leq FFH$

Function: Display the bit image data inputted on the cursor position real-time.

Cursor position will not change.

When bit image is display from cursor position, and if it overflows from the area of current window, it is displayed until edge of area, and remaining bit image overflowed is not displayed. If the Display position or image size e.t.c are defined to out of definable area, the command is ignored, and the data is valid as standard data.

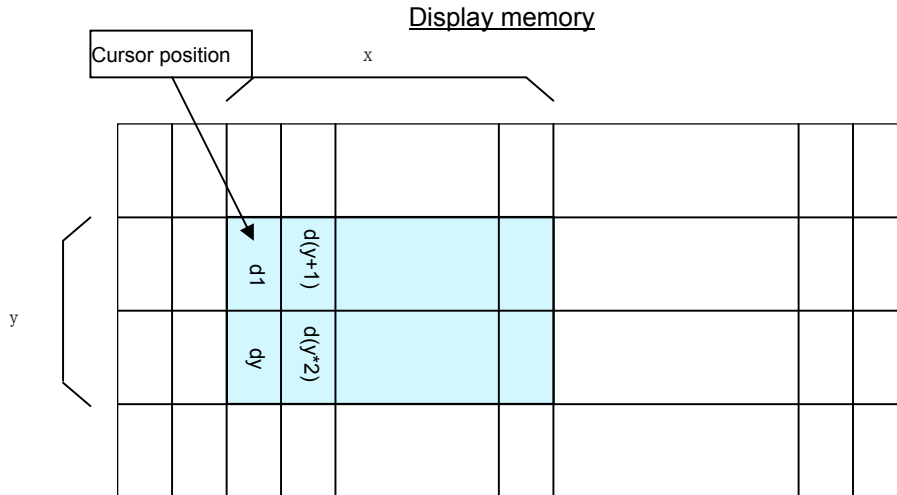

**3.7.4.28 US (f n aL aH aE sL sH sE d(1)...d(s) (RAM bit image definition)**

**Code:** 1FH 28H 66H 01H aL aH aE sL sH sE d(1)...d(s)

- n: Classify the command
- aL: Bit image data definition address lower byte
- aH: Bit image data definition address upper byte
- aE: Bit image data definition address extension byte
- sL: Bit image data length lower byte
- sH: Bit image data length upper byte
- sE: Bit image data length extension byte
- d(1) - d(s) : Image data (Refer to figure as follows)

Definable area: n = 01H

$$000000H \leq (aL + aH \times 100H + aE \times 10000H) \leq 0003FFH$$

$$000001H \leq (sL + sH \times 100H + sE \times 10000H) \leq 000400H$$

$$00H \leq d \leq FFH$$

Function: Define user bit image to the RAM.

The bit image data can be defined or changed by Bit image data definition address and Bit image data length as above. The bit image defined in RAM can be displayed by by "3.7.4.30 Downloaded bit image display" command.. The definable capacity of RAM bit image is 1024 bytes. If the Bit image data definition address and Bit image data length is defined to out of definable area, the command is ignored, and the data is valid as standard data.

Example : RAM Bit image definition memory  
 Define 8 bytes data "0Ah,0Bh,0Ch,0Dh,0Eh,0Fh,10h,11h" from definition address "00000Ah"  
 (Code) 1Fh 28h 66h 01h 0Ah 00h 00h 08h 00h 00h 0Ah 0Bh 0Ch 0Dh 0Eh 0Fh 10h 11h

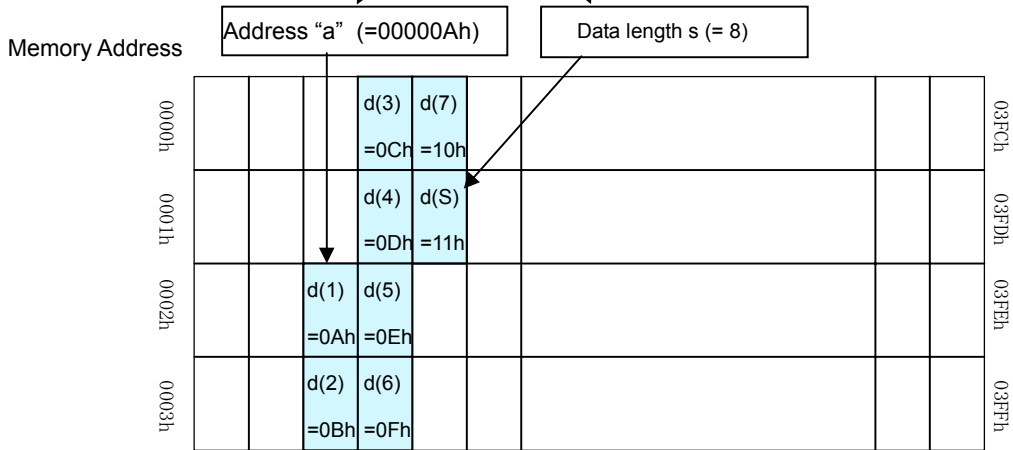

**3.7.4.29 US ( e n aL aH aE sL sH sE d(1)...d(s) (FROM bit image definition)**

**Code:** 1FH 28H 65H 10H aL aH aE sL sH sE d(1)...d(s)

- n: Classifies the command
- aL: Bit image data definition address lower byte (Bit0 is invalid.)
- aH: Bit image data definition address upper byte
- aE: Bit image data definition address extension byte
- sL: Bit image data length lower byte (Bit0 is invalid.)
- sH: Bit image data length upper byte
- sE: Bit image data length extension byte
- d(1) - d(s) : Image data (Refer to figure as follows)

Definable area: n = 10H

aE = 00H~04H

**aE = 00H**

$$000000H \leq ((aL \& FEH) + aH \times 100H + aE \times 10000H) \leq 007FFEh$$

$$000002H \leq ((sL \& FEH) + sH \times 100H + sE \times 10000H) \leq 008000h$$

**aE = 01H~04h (Extension area, 4 blocks.)**

$$010000H \leq ((aL \& FEH) + aH \times 100H + aE \times 10000H) \leq 04FFFEh$$

$$000002H \leq ((sL \& FEH) + sH \times 100H + sE \times 10000H) \leq 010000H$$

$$00H \leq d \leq FFH$$

Function: Define user bit image to the FROM.

The definable capacity of FROM bit image is 32,768 bytes + Extension area 262,144 bytes.

The bit image data can be defined or changed by Bit image data definition address and Bit image data length.

The bit image defined in FROM can be displayed by "3.7.4.30 Downloaded bit image display" command.

If Bit image definition address and Bit image data length is overflow from definable area, the command is cancelled, and the "d" data is executed as standard data.

The data "Bit 0" of Bit image definition address and Bit image data length are invalid, and executed as even number in any case.

**This command is valid at the user setup mode.**

It becomes Display BUSY during processing of this command, please do not send the any data from a host during Displays BUSY.

**When aE = 00h is defined.**

Total definable area is 000000h to 007FFFh =32,768 bytes, Bit image definition is performed per 2byte.

**When aE = 01h~04h are defined.**

Total extension definable area is 010000H to 04FFFFH =262,144 bytes, and separated by 4 blocks, and each block can be selected by aE (extension byte).



If Bit image data length is defined to out of area of block selected, the command is ignored. The Bit image data can not be defined across the next block area continuously. Bit image definition is performed per 64KB (xx0000h~xxFFFFh), the new data will be written to the FROM after existing data of all of FROM area is removed. Therefore, the existing data which will be not re-written are set to FFh.

The definition contents when definition error is occurred are not guaranteed.

Example1: FROM Bit image definition memory In case of aE=00h

Define 8 bytes data "0Ah,0Bh,0Ch,0Dh,0Eh,0Fh,10h,11h" from definition address "00000Ah"

(Code) 1Fh 28h 65h 10h 0Ah 00h 00h 08h 00h 00h 0Ah 0Bh 0Ch 0Dh 0Eh 0Fh 10h 11h

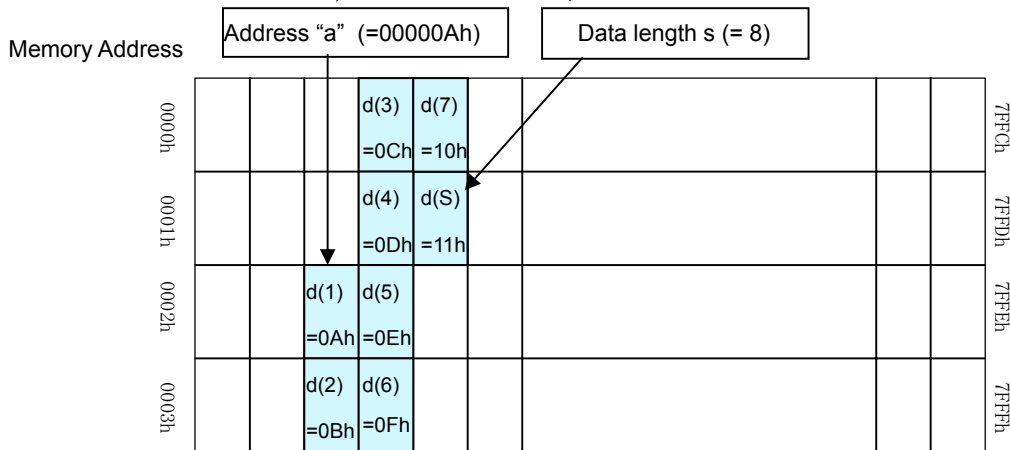

Example2: FROM Bit image definition memory In case of aE=01h

Define 8 bytes data "0Ah,0Bh,0Ch,0Dh,0Eh,0Fh,10h,11h" from definition address "01000Ah"

(Code) 1Fh 28h 65h 10h 0Ah 00h 01h 08h 00h 00h 0Ah 0Bh 0Ch 0Dh 0Eh 0Fh 10h 11h

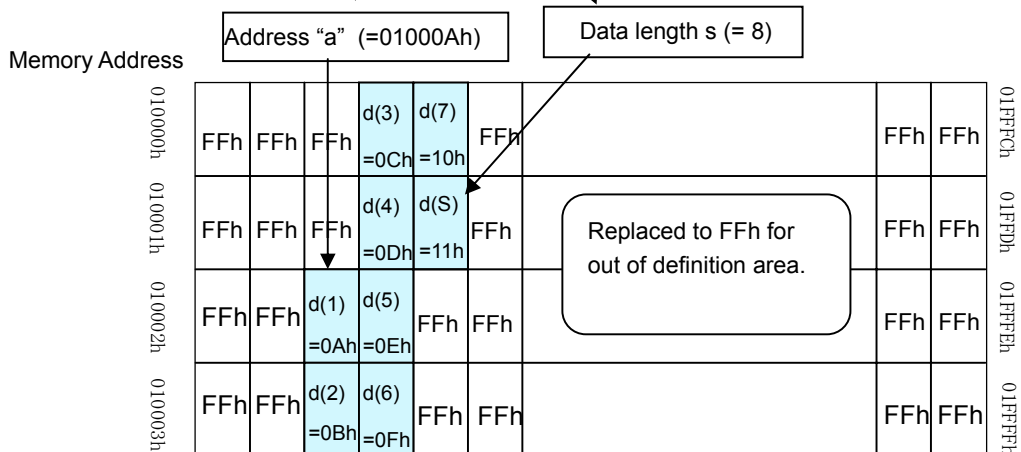

Note: Area of aE=02h~04h are also performed as same condition as above.

**3.7.4.30 US ( f n m aL aH aE ySL ySH xL xH yL yH g) (Downloaded bit image display)****Code: 1FH 28H 66H 10H m aL aH aE ySL ySH xL xH yL yH g**

n: Classify the command  
 m: Select bit image data display memory  
 aL: Bit image data definition address lower byte  
 aH: Bit image data definition address upper byte  
 aE: Bit image data definition address extension byte  
 ySL: Bit image defined, Y size lower byte (by 8dots)  
 ySH: Bit image defined, Y size upper byte (by 8dots)  
 xL: Bit image display X size lower byte (by 1dot)  
 xH: Bit image display X size upper byte (by 1dot)  
 yL: Bit image display Y size lower byte (by 8dots)  
 yH: Bit image display Y size upper byte (by 8dots)  
 g: Image =1 (Fixed)

Definable area: n = 10H

 $00H \leq m \leq 02H$ 

m = 00H: RAM bit image  
 m = 01H: FROM bit image  
 m = 02H: Display memory bit image

**When RAM bit image is selected;** $000000h \leq (aL + aH \times 100h + aE \times 10000h) \leq 0003FFh$ **When FROM bit image is selected;****aE = 00H** $000000H \leq (aL + aH \times 100h + aE \times 10000H) \leq 007FFFH$ **aE=01H~04H (Extension area, 4 blocks.)** $010000H \leq (aL + aH \times 100H + aE \times 10000H) \leq 04FFFFH$ **When Display memory bit image selected;** $000000h \leq (aL + aH \times 100h + aE \times 10000h) \leq 000FFFh$  $0000H \leq (ySL + ySH \times 100H) \leq FFFFH$  $0001H \leq (xL + xH \times 100H) \leq 0400H$  $0001H \leq (yL + yH \times 100H) \leq 0004H$ 

g=01H

Function: Display the RAM, FROM bit image defined or display copy of Display memory bit image defined on cursor position.

The cursor position will not change.

Select RAM, FROM or Display memory bit image by Select Bit image data display memory "m".

The Y size of Bit image defined should be same size as Y size that is defined to each memory.

The part of bit image defined can be displayed by setting Bit Image Defined, Y size > Bit Image

Display, Y Size, or, changing Bit image data definition address. When bit image is displayed on cursor position, and if it overflows from the area of current window, it is displayed until edge of area, and remaining bit image overflowed is not displayed.

When bit image is displayed on cursor position, if it overflows from bit image memory area, irregular bit image is displayed.

**Note: When aE = 01h~04h are defined.**

Extension area is separated by 4 blocks. But the data are defined to 010000H~04FFFFH continuously, and can download the continuous data regardless of each block area.

If the specified area of bit image data is overflow from 010000H~04FFFFH, The display contents become unfixed display pattern.

Bit image memory (RAM, FROM or Display memory)

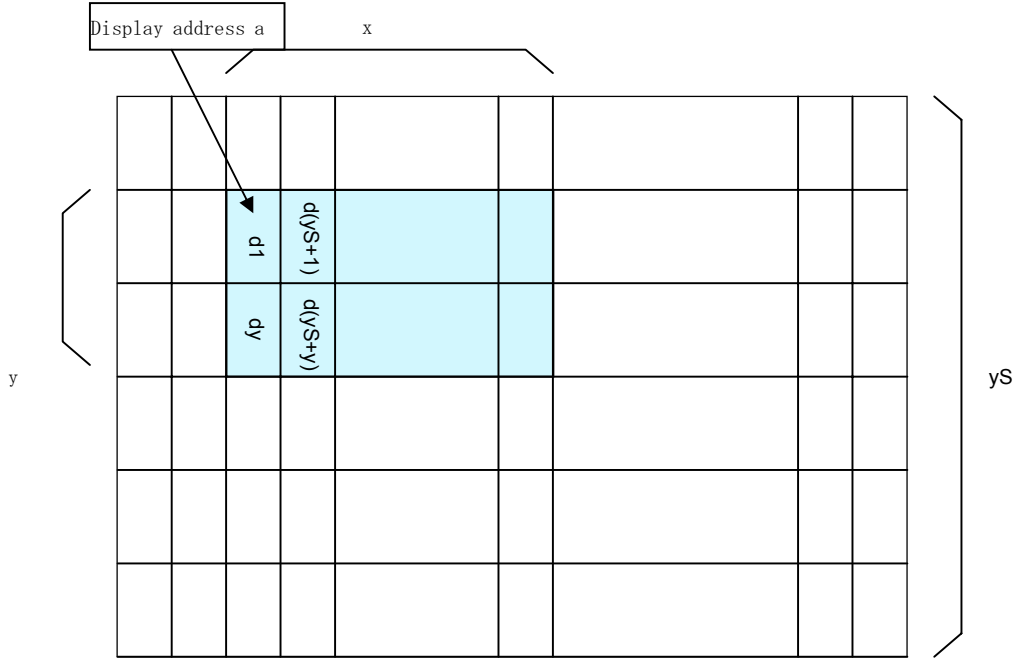

Bit image data write



Display memory

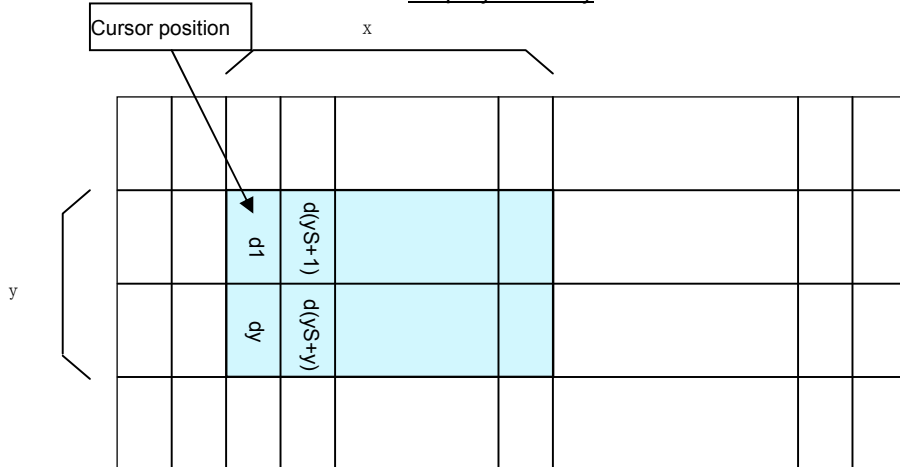

**3.7.4.31 US ( f n m aL aH aE ySL ySH xL xH yL yH g s ) (Downloaded bit image scroll display)**Code: **1FH 28H 66H 90H m aL aH aE ySL ySH xL xH yL yH g s**

n: Classify the command  
 m: Select bit image data display memory  
 aL : Bit image data definition address lower byte  
 aH: Bit image data definition address upper byte  
 aE: Bit image data definition address extension byte  
 ySL: Bit image defined, Y size lower byte (by 8dots)  
 ySH: Bit image defined, Y size upper byte (by 8dots)  
 xL: Bit image scroll display shift X size lower byte (by 1dot)  
 xH: Bit image scroll display shift X size upper byte (by 1dot)  
 yL: Bit image scroll display Y size lower byte (by 8dots)  
 yH: Bit image scroll display Y size upper byte (by 8dots)  
 g: Image =1 (Fixed)  
 s: Scroll speed select

Definable area: n = 90H

 $00H \leq m \leq 01H$ 

m = 00H: RAM bit image

m = 01H: FROM bit image

**When RAM bit image is selected;** $000000h \leq (aL + aH \times 100h + aE \times 10000h) \leq 0003FFh$ **When FROM bit image is selected;****aE = 00H** $000000H \leq (aL + aH \times 100h + aE \times 10000H) \leq 007FFFH$ **aE=01H~04H (Extension area, 4 blocks.)** $010000H \leq (aL + aH \times 100H + aE \times 10000H) \leq 04FFFFH$  $0000H \leq (ySL + ySH \times 100H) \leq FFFFH$  $0001H \leq (xL + xH \times 100H) \leq 0400H$  $0001H \leq (yL + yH \times 100H) \leq 0004H$ 

g=01H

s=00H~1FH

s	Scroll speed
00h	4dots/14msec
01h	2dots/14msec
02h~1Fh	1dot/(s-1) × 14 msec

Function: Scroll display the RAM or FROM bit image defined from the right end of current window that cursor is located.

The cursor position will not change.

Select RAM, FROM or Display memory bit image by Select Bit image data display memory "m".

The Y size of Bit image defined should be same size as Y size that is defined to each memory.

The some part of bit image defined can be displayed by setting Bit Image Defined, Y size > Bit Image Display, Y Size, or, changing Bit image data definition address.

**Note: When aE = 01h~04h are defined.**

Extension area is separated by 4 blocks. But the data are defined to 010000H~04FFFFH continuously, and can download the continuous data regardless of each block area.

If the specified area of bit image data is overflow from 010000H~04FFFFH, The display contents become unfixed display pattern.

Attention: "Scroll speed" is an approximate value. It may become sometime slow down or may flicker depending on scroll size. **Scroll speed-priority or Visual quality-priority can be selected as scroll display condition. Refer to 3.7.4.32 Horizontal scroll display quality select.**

Bit image memory (RAM, FROM)

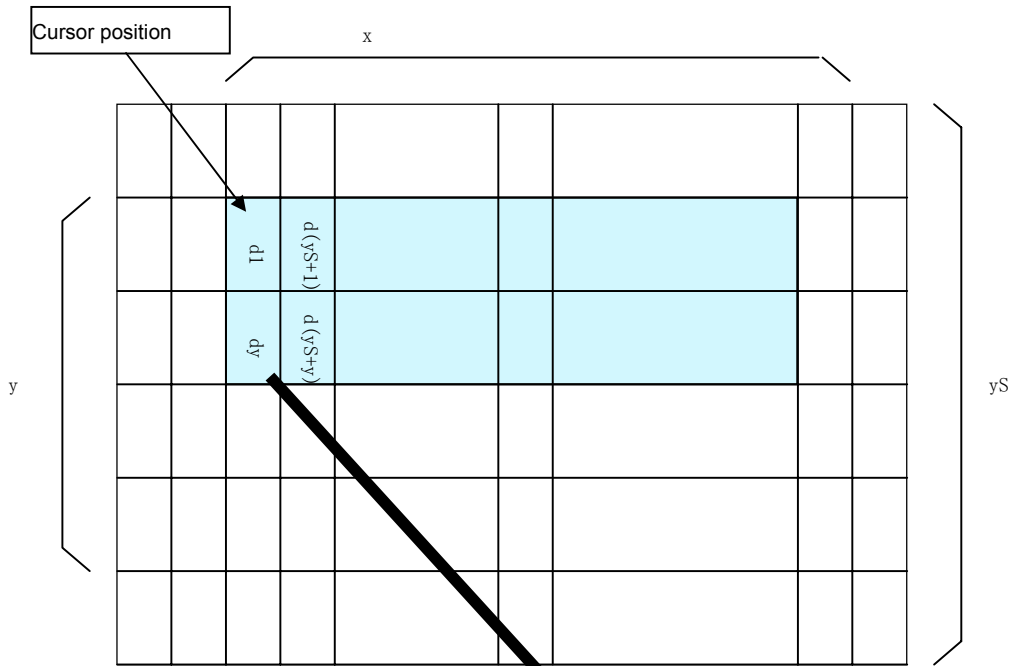

Write bit image data from the right end of current window that cursor is located.  
(Scroll display)

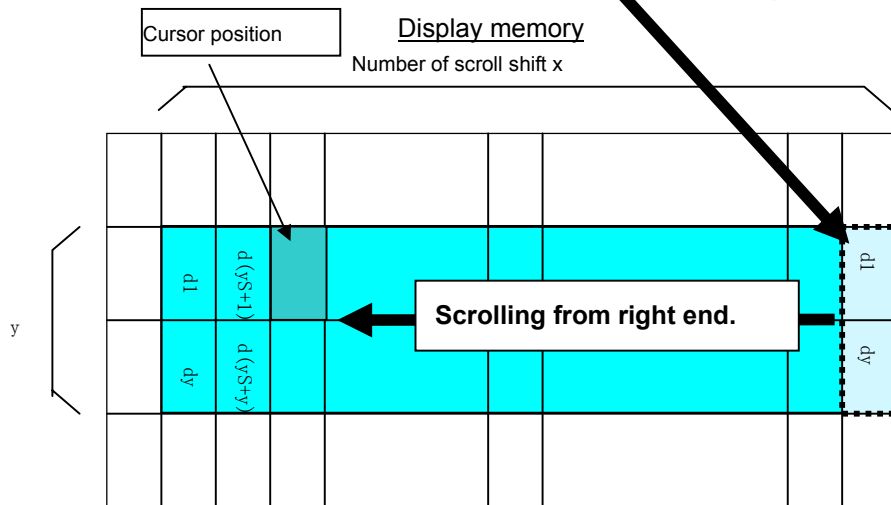

**3.7.4.32 US m n (Horizontal scroll display quality select)****Code: 1FH 6DH n**

n : Select horizontal scroll display quality

Definable area:  $00H \leq n \leq 01H$ 

n=00H: Scroll speed-priority

n=01H: Visual quality-priority

Default: n=00H or depending on Memory SW.

Function: Select horizontal scroll display quality, Scroll speed-priority or Visual quality-priority.

If Scroll speed-priority is selected, scroll speed become faster, but partial display flickering will be increased.

If Visual quality-priority is selected, partial display flickering will be decreased, but scroll speed become slower.

**3.7.4.33 US r n (Specifies or cancels reverse display)****Code: 1FH 72H n**

n : Specify or cancel reverse display

Definable area:  $00H \leq n \leq 01H$ 

n=00H: Cancel reverse mode

n=01H: Specify reverse mode

Default: n=00H or depending on Memory SW.

Note: This command is valid to the new data after this command is specified.

This does not affect the contents already displayed.

**3.7.4.34 US w n (Specifies write mixture display mode)****Code: 1FH 77H n**

n : Specify display write mode

Definable area:  $00H \leq n \leq 03H$ 

n = 00H: Normal display write. (Not mixture display)

n = 01H: OR display write

n = 02H: AND display write

n = 03H: EX-OR display write

Default: n = 00H or depending on Memory SW.

Note: Specifies write mixture mode. The new character or graphic image display mixed with current display image stored in display memory is overwritten to the display memory.

**3.7.4.35 US ( w n a (Current Window select)****Code: 1FH 28H 77H 01H a**

n: Classify command

a: Current window number

a = 00H: Base-Window

a = 01H ~ 04H: User-Window

Definable area: n = 01H

 $00H \leq a \leq 04H$ 

Function: Select current window

This command is ignored if current window number is specified for User-Window that is not defined.

**3.7.4.36 US ( w n a b[xPL xPH yPL yPH xSL xSH ySL ySH] (User Window definition-cancel)**

**Code:** 1Fh 28h 77h n a b [xPL xPH yPL yPH xSL xSH ySL ySH]

n: Classify command  
a: Definable window No. No.1 ~ 4  
b: Define or Cancel b=00H : Cancel, b=01H: Define  
xPL: Left position of window x lower byte ( by 1dot)  
xPH: Left position of window x upper byte ( by 1dot)  
yPL: Top position of window y lower byte ( by 8dot)  
yPH: Top position of window y upper byte ( by 8dot)  
xSL: X size of window lower byte ( by 1dot)  
xSH: X size of window upper byte ( by 1dot)  
ySL: Y size of window lower byte ( by 8dot)  
ySH: Y size of window upper byte ( by 8dot)

Definable area: n = 02H  
 $01H \leq a \leq 04H$   
 $00H \leq b \leq 01H$   
 $0000H \leq (xPL + xPH \times 100H) \leq 03FFH$   
 $0000H \leq (yPL + yPH \times 100H) \leq 0003H$   
 $0001H \leq (xSL + xSH \times 100H) \leq 0400H$   
 $0001H \leq (ySL + ySH \times 100H) \leq 0004H$

Function: Define or cancel User-Window  
Display contents are remained even if this command is executed.

**When User-Window is defined (b=01H)**

Specify Definable Window No., Window position and Window size, and Window position and Window size are specified by the block (Block/1x8dot)  
User-Window can be defined up to 4 windows.  
The cursor position after excuted this command is specified to top left (X=0, Y=0).

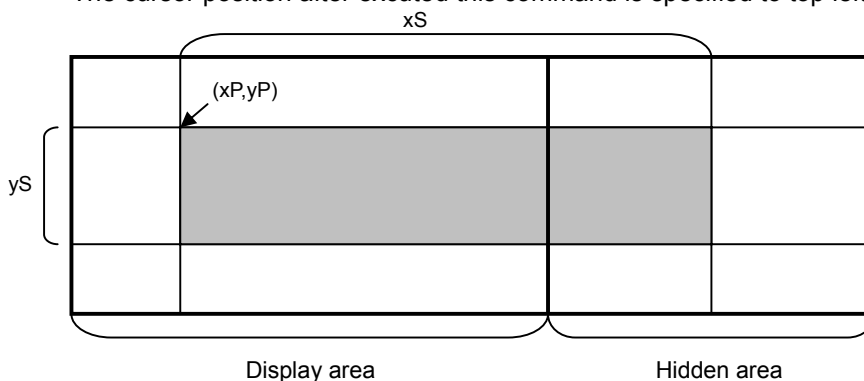

**When User-Window is canceled (b=00H)**

It is not necessary to specify window position [xPL~ySH] in case of cancel the User-Window .  
The Base-Window is selected as current window in case of user window canceled was selected as current window.

**3.7.4.37 ESC % n (Specify Download Character)****Code:** 1BH 25H n

Function: Specify enable or disable for each download character.

n = 01H: Enable (If download character is not defined, built-in character is displayed)

n = 00H: Disable (Characters already downloaded, defined, and displayed are not affected)

**3.7.4.38 ESC & a c1 c2 [x1 d1...d(y×x1)]...[xk d1...d(y×xk) (Download character definition)****Code:** 1BH 26H a c1 c2 [x1 d1...d(y×x1)]...[xk d1...d(y×xk)]

a: Select character type

c1: Start character code

c2: End character code

x: Number of dot for X direction

d: Defined data (See sect. 7.3 - Download character format)

Definable area: 01H ≤ a ≤ 02H

a = 01H: Select 6x8 dot character

00H ≤ x ≤ 06H

a = 02H: Select 8x16 dot character

00H ≤ x ≤ 08H

20H ≤ c1 ≤ c2 ≤ FFH

00H ≤ d ≤ FFH

k = c2 - c1 + 1

Function: Define 6 x 8 or 8 x 16 dot download characters (1byte character) into RAM.

**This is not available for 16x32 dot font.**

A maximum of 16 characters may be downloaded and defined within each font size.

After the first 16 are defined, any additional characters required must replace one already defined. Downloaded characters are valid until they redefined, an initialize (ESC@) sequence is executed, or the power is turned off. To display the download character, execution of "Download character definition" and "Specify download character" is required. In case of the X width is smaller than definable character width, the blank will be shown on remaining dots. In case of displaying download character is re-defined, displaying character is not changed, new download character is applied from new data. The download character can be memorized into FROM by command of "Save download character".

**3.7.4.39 ESC ? a c (Delete downloaded character)****Code:** 1BH 3FH a c

x: Select character

c: Delete Character code

Definable area: 01H ≤ a ≤ 02H

a = 01H: Select 6x8 dot character

a = 02H: Select 8x16 dot character

20H ≤ c ≤ FFH

Function: Delete defined 6x8 or 8x16 dot download character.

The built-in character is displayed after this command is executed.

It does not affect to the displaying download character.

This command is ignored if character code for download character is not defined.



**3.7.4.40 US ( g n c1 c2 d1...dk (16x16 download character definition)****Code:** 1FH 28H 67H 10H c1 c2 d1...dk

n: Classify command

c1: Character code upper byte

c2: Character code lower byte

d: Definition data (Refer 7.3 Download character format)

Definable area: n = 10H

c1, c2 depending on language.

Language	Code	c1	c2
Japanese	JIS X0208 (SHIFT-JIS)	c1 = ECh	40H ≤ c2 ≤ 4FH
Korean	KSC5601-87	c1 = FEh	A1h ≤ c2 ≤ B0h
Simplified Chinese	GB2312-80	c1 = FEh	A1h ≤ c2 ≤ B0h
Traditional Chinese	Big-5	c1 = FEh	A1h ≤ c2 ≤ B0h

00H ≤ d ≤ FFH

k = 32

Function: Defines the 16 x 16 downloaded character (2bytes character) in code specified by c1 and c2. A maximum 16 characters can be defined. Definition data "d" is processed as character pattern data with column format, and this is stored sequentially from the left end. Download character is temporary stored in RAM and also can be stored in FROM by "Save download character" command.

**3.7.4.41 US ( g n c1 c2 (16x16 downloaded character delete)****Code:** 1FH 28H 67H 11H c1 c2

n: Classify command

c1: Character code upper byte

c2: Character code lower byte

Definable area: n = 11H

c1, c2 depending on language.

Language	Code	c1	c2
Japanese	JIS X0208 (SHIFT-JIS)	c1 = ECh	40H ≤ c2 ≤ 4FH,
Korean	KSC5601-87	c1 = FEh	A1h ≤ c2 ≤ B0h
Simplified Chinese	GB2312-80	c1 = FEh	A1h ≤ c2 ≤ B0h
Traditional Chinese	Big-5	c1 = FEh	A1h ≤ c2 ≤ B0h

Function: Delete the 16 x 16 downloaded character in code specified by c1 and c2.

**3.7.4.42 US ( e n a (Save downloaded character)****Code:** 1FH 28H 65H 11H a

n: Classify command

a: Select font type

Definable area: n = 11H

01H ≤ a ≤ 03H

a=01H: 6x8 dot

a=02H: 8x16 dot

a=03H: 16x16 dot

Function: Save the download character already defined on RAM to the FROM.  
This content is valid after specified "Download character transfer" command.  
**This command is valid at the user setup mode defined.**

**3.7.4.43 US ( e n a (Download character transfer)****Code: 1FH 28H 65H 21H a**

n: Classify command

a: Classify font

Definable area: n = 21H

01H ≤ a ≤ 03H

a = 01H : 6x8dot

a = 02H : 8x16 dot

a = 03H : 16x16 dot

Function: Transfer the download character defined in FROM to RAM.

The command is ignored if specified download character is not registered in FROM.

This command is valid at the both of user setup and Normal mode defined.

**3.7.4.44 US ( e n m P(80h-1) P(80h-2)...P(FFh-n) (FROM User font definition)****Code: 1Fh 28h 65h 13h m P(80h-1) P(80h-2)...P(FFh-n)**

n: Classify command

m: User table select

p: Definition data (Refer 7.3 Download character format)

Definable area: n = 13H

m=01H, 02H, 04H

m = 01H : 6x8dot user table

m = 02H : 8x16 dot user table

m = 04H : 16x32 dot user table

m=01h: P(80h-1).....P(80h-6).....P(FFh-6) 6 Bytes / font x 128 characters (768 bytes)

m=02h: P(80h-1).....P(80h-16).....P(FFh-16) 16 Bytes / font x 128 characters (2,048 bytes)

m=04h: P(80h-1).....P(80h-64).....P(FFh-64) 64 Bytes / font x 128 characters (8,192 bytes)

Function: Define the each size of 1 byte user font to the user table.

All of 128 character / table should be defined at once, it can not define some part of user font address only. All of user tables are set to "00H"(Blank) as default setting.

**This command is valid at the user setup mode.****3.7.4.45 US ( e n d1 d2 (User set up mode start)****Code: 1FH 28H 65H 01H 49H 4EH**

Definable area: n = 01H

d1 = 49H (Character "I")

d2 = 4EH (Character "N")

Function: Start user set up mode.

The data can be sent from RS-232 serial interface.

This command is valid at the Normal mode.

Clear the display screen after this command is executed.

Send data	Hex	Number of data
1: Header	28H	1byte
2: Discrimination 1	65H	1byte
3: Discrimination 2	01H	1byte
4: NUL	00H	1byte

**3.7.4.46 US ( e n d1 d2 d3 (User set up mode - end)****Code: 1FH 28H 65H 02H 4FH 55H 54H**

Definable area: n = 01H

d1 = 4FH (Character "O")

d2 = 55H (Character "U")

d3 = 54H (Character "T")

Function: End user set up mode, and software reset of display is executed as follows:

1. Confirm the end of execution (for memory control, data send e.t.c.)

2. Display busy signal is output.

3. Software reset is executed.

**This command is valid at the user setup mode.**

After this command is executed, software reset is executed, the receiving buffer is cleared, and all settings (download character, macro, e.t.c.) are reset to a power on condition.

**3.7.4.47 US ( p 01h n a (I/O Port Input/Output setting)****Code:** 1FH 28H 70H 01H n a

n : I/O port number

a : Set Input or Output

Definable area: 00H ≤ n ≤ 01H

n = 00H: Port 0

n = 01H: Port 1

00H ≤ a ≤ FFH

Bit value = 0 : Input

Bit value = 1 : Output

Function: Set input or output for general purpose I/O port.

Input/output port can be selected by value of a. Refer to bit assignment.

Port Bit No.	Bit7	Bit6	Bit5	Bit4	Bit3	Bit2	Bit1	Bit0
Data of a	D7	D6	D5	D4	D3	D2	D1	D0

Port 1 is used only for Input, Do not use for output control.

**Attention:** The I/O Port is designed in consequence of the peripheral device simple control such Key Switch, Lamp and etc. Please refrain to apply it for applications that high reliability condition is required.**3.7.4.48 US ( p 10h n a (I/O Port Output)****Code:** 1FH 28H 70H 10H n a

n : I/O port number

a : Output data value

Definable area: 00H ≤ n ≤ 01H

n = 00H: Port 0

n = 01H: Port 1

00H ≤ a ≤ FFH

Function: Output the data to selected general purpose I/O port.

Output data can be changed by value of a. Refer to bit assignment.

Port Bit No.	Bit7	Bit6	Bit5	Bit4	Bit3	Bit2	Bit1	Bit0
Data of a	D7	D6	D5	D4	D3	D2	D1	D0

Port 1 is used only for Input, Do not use for output control.

**3.7.4.49 US ( p 20h n (I/O Port Input)****Code:** 1Fh 28h 70h 20h n

n : I/O port number

Definable area: 00H ≤ n ≤ 01H

n = 00H: Port 0

n = 01H: Port 1

Function: The state of a general purpose I/O port is transmitted via RS-232 serial interface.

Send data	Hex	Number of data
1: Header	28H	1byte
2: Discrimination 1	70H	1byte
3: Discrimination 2	20H	1byte
4: Data	00H~FFH	1byte

Data transmission time depends on the condition of receiving buffer.

**3.7.4.50 US : pL pH [d1...dk] (RAM Macro processing definition)**

**Code: 1FH 3AH pL pH [d1...dk]**

pL: RAM Macro data length lower byte

pH: RAM Macro data length upper byte

d : RAM Macro data

Definable area:  $0000h \leq (pL + pH \times 100h) \leq 0100h$

Function: Define or delete of RAM Macro or RAM Program Macro processing definition.

(pL + pH×100h)>0000h: The "d" data is defined as Macro.

(pL + pH×100h)=0000h: Macro is deleted.

Note: If Macro data length is overflow from definable area, the command is cancelled, and the "d" data is executed as standard data.

Please do not define the following commands;

"Initialize", "Macro execution", "RAM Macro processing definition", "FROM Macro processing definition", "User set up mode start", "User set up mode end", "FROM Bit image definition", "Save downloaded character", "Memory SW setting", "Memory SW data send", "Download character transfer", "Display status send", "FROM User font definition", "Memory re-write mode shift"

**About Program macro, refer to "DS-954-0003-XX Program Macro" spec for detail.**

**3.7.4.51 US ( e n a pL pH t1 t2 [ d(1)...d(p) ] (FROM Macro processing definition)****Code: 1Fh 28h 65h 12h a pL pH t1 t2 [d1...d(p)]**

n : Classify command  
 a : FROM Macro registration number  
 pL: FROM Macro data length lower byte  
 pH: FROM Macro data length upper byte  
 t1: Display time interval (t1 x approx.14ms)  
 t2: Idle time of macro repetition (t2 x aprox.14ms)  
 d: FROM Macro data

Definable area: n = 12H

 $01H \leq a \leq 04H$  $0000H \leq (pL + pH \times 100h) \leq 1000H$  $00H \leq t1 \leq FFH$  $00H \leq t2 \leq FFH$  $00H \leq d \leq FFH$ **Function:** Define or delete FROM Macro or FROM Program Macro to the FROM

(pL + pH X 256) &gt; 0: Data "d" is defined and registered.

(pL + pH X 256) = 0: The Macro already defined is deleted.

t1 and t2 is applied in case of "FROM Macro execution at power on" is valid.

Display time interval refers to the interval time for a display action, and does not affect the processing speed of command code. Idle time refers to the time until a macro is re-executed. If the Macro data length is defined to out of definable area, the command is ignored, and the data is valid as standard data. **This command is valid at the user setup mode defined.**

It becomes Display BUSY during processing of this command, please do not send the any data from a host during Displays BUSY.

Please do not define the following commands;

"Initialize", "Macro execution", "RAM Macro processing definition", "FROM Macro processing definition", "User set up mode start", "User set up mode end", "FROM Bit image definition", "Save downloaded character", "Memory SW setting", "Memory SW data send", "Download character transfer", "Display status send", "FROM User font definition", "Memory re-write mode shift"

**About Program macro, refer to "DS-954-0003-XX Program Macro" spec for detail.****3.7.4.52 US ^ n t1 t2 (Macro execution)****Code: 1FH 5EH a t1 t2**

a: Macro processing definition number

t1: Display time interval (t1 x approx.14ms)

t2: Idle time of macro repetition (t2 x aprox.14ms)

Definable area:  $00h \leq a \leq 04h, 80h \leq a \leq 84h$ 

a = 00H : RAM Macro 0

 $01H \leq a \leq 04H$  : FROM Macro 1 – 4

a = 80H : RAM Program Macro 0

 $81H \leq a \leq 84H$  : FROM Program Macro 1 – 4 $00h \leq t1 \leq FFh$  $00h \leq t2 \leq FFh$ 

**Function:** Macros are executed continuously. Display time interval refers to the interval time for a display action, and does not affect the processing speed of command code. Idle time refers to the time until a macro is re-executed. If macro "a" is not defined, or, is defined out of the definable area, the data specified until t2 is ignored. Command inputted when a macro is executing will cause execution to be ended, the display contents on current window (Write screen mode area in case of Base-Window is selected as current window) is cleared, the cursor position is moved to "home", and setting will revert to those at the end of macro's execution.

**3.7.4.53 US ( e n a b (Memory SW setting)****Code: 1FH 28H 65H 03H a b**

n: Classify command  
 a: Memory SW Number  
 b: Setting data

Definable area: n = 03H  
 $00h \leq a \leq 1Fh$   
 $00h \leq b \leq FFh$

Function: Set the contents of data“b” to memory SW “a”.

**This command is valid at the user setup mode.**

It becomes Display BUSY during processing of this command, please do not send the any data from a host during Displays BUSY.

Refer to 5.2 Memory SW

**3.7.4.54 US ( e n a (Memory SW data send)****Code: 1FH 28H 65H 04h a**

n: Classify command  
 a: Memory SW Number

Definable area: n = 04h  
 $00h \leq a \leq 1Fh$

Function: Send the the contents of memory SW data “a”.

The following data are sent from RS-232 serial interface.

Send data	Hex	Number of data
1: Header	28H	1byte
2: Discrimination 1	65H	1byte
3: Discrimination 2	04H	1byte
4: Data	00H~FFH	1byte

This command is valid at the both of user setup and Normal mode.

Refer to 5.2 Memory SW

**3.7.4.55 US ( e n a [b c ] (Display status send)****Code: 1FH 28H 65H 40H a [b c ]**

Definable area: n = 40H

a= 01H : Boot version information (b c are not used)  
 a= 02H : Firmware version information (b c are not used)  
 a= 10H : 2bytes character code information (b c are not used)  
 a= 11H : Language type information (b c are not used)  
 a= 20H : Memory check sum information  
 $00H \leq b \leq FFH$  : Start address (Valid address = b x 10000h)  
 $00H \leq c \leq FFH$  : Data length (Valid data length = c x 10000h)  
 a= 30H : Product type information (b c are not used)  
 a= 40H : Display x dot information (b c are not used)  
 a= 41H : Display y dot information (b c are not used)

Function: Send each display status information.

The following data are sent from RS-232 serial interface.

This command is valid at the both of user setup and Normal mode defined.

Send data	Hex	Number of data
1: Header	28H	1byte
2: Discrimination 1	65H	1byte
3: Discrimination 2	40H	1byte
4: Data	00H~FFH	a = 01H : 4 bytes a = 02H : 4 bytes a = 10H : 15 bytes a = 11H : 15 bytes a = 20H : 4 bytes a = 30H : 15 bytes a = 40H : 3 bytes a = 41H : 3 bytes

### 3.7.4.56 FS | M m d1...d6 (Memory re-write mode shift)

**Code:** 1CH 7CH 4DH m d1 ... d6

Definable area: m = D0H  
d1...d6 = "MODEIN"

**Function:** Shift to "Memory re-write mode" from "Normal mode".  
Memory re-write mode is used for changing the firmware, a font, etc on FROM that cannot be changed by user setup mode, and Re-write tool is required.  
Do not use this command usually.

### 3.8 Bit image data format

The Bit image consists of the data for image size (x \* y) as follows;

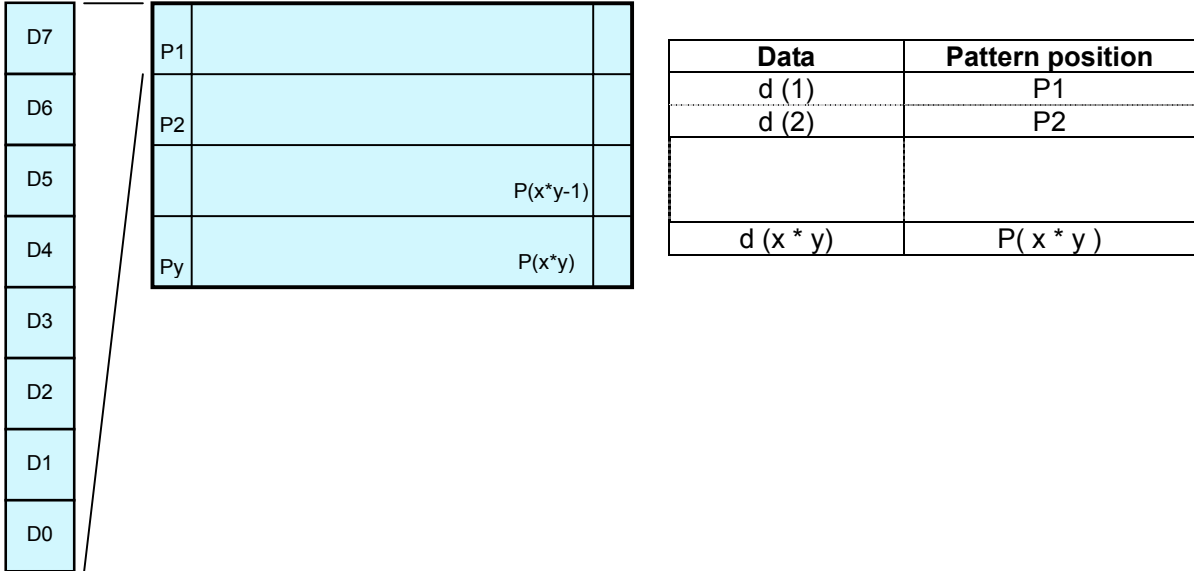

### 3.9 Download character format

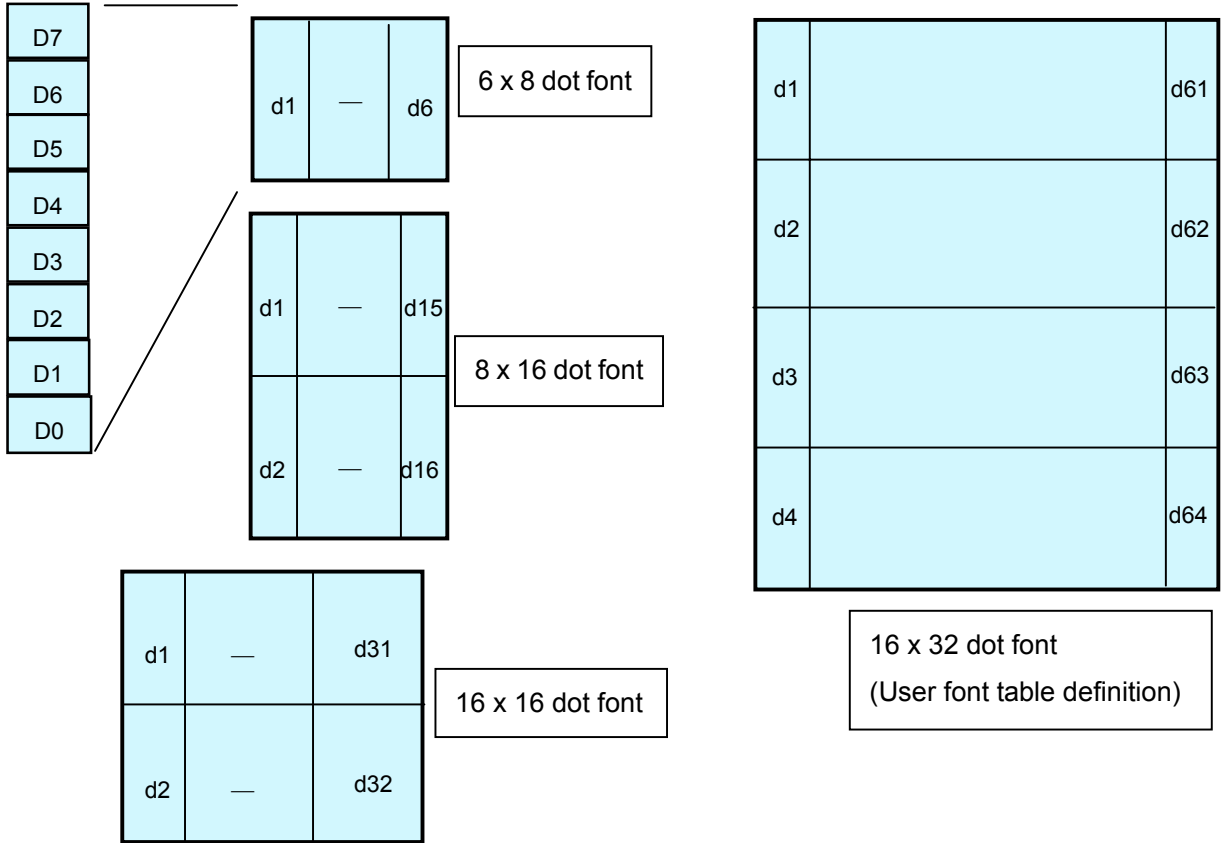



## 4 Graphic DMA mode (Applying for Parallel interface only)

### 4.1 Displayable image types

#### 4.1.1 Graphic display

256 x 32 dots

### 4.2 Display memory

Size: 1,024 x 32 dots

Any position of display area can be displayed by "Specify Display start address" command. Display area has roll structure, the bit image data located on "0000H" line comes back from the right end when screen area is overflowed from right end of display memory area.

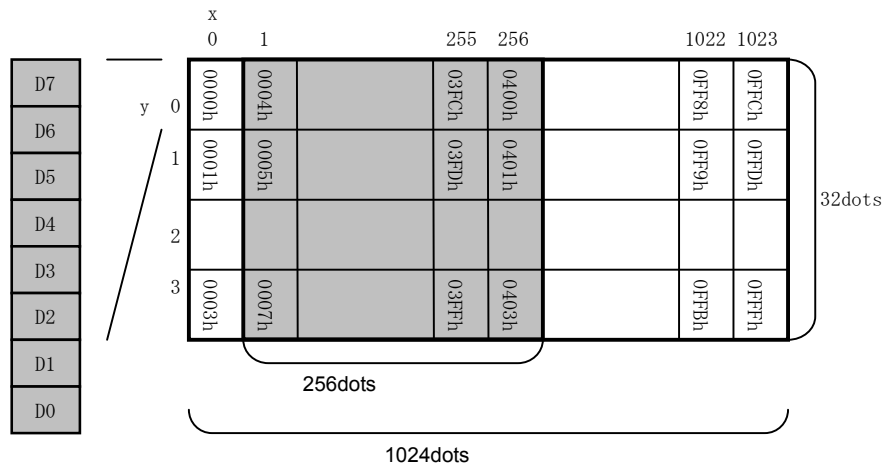

### 4.3 Protocol

The module can receive the data/command via parallel interface with high-speed data writing. High-speed graphic display is possible using this mode.

If "Header (STX)", "Header 2" is not completely receipt, the display waits until when receive next header (STX).

The data corresponding between the addresses of DIP SW and display address are transacted. Under this mode, 16 pcs (max) of display can be controlled independently. Each display needs to be addressed by the DIP switch. If the address data is defined as FFH, all of modules cascaded accept the same data.

Header	Header 2	Address	Command/Data
STX (02H)	44H	00H~FFh	00H~FFH
1byte	1byte	1byte	n byte

## 4.4 Commands

Command Name	Hex Code	Operation	Page
Bit image write	02h 44h DAD 46h aL aH sL sH d1...ds	Write bit image data to the write address specified. DAD: Display address aL: Bit image write address lower byte aH: Bit image write address upper byte sL: Bit image write size lower byte sH: Bit image write size upper byte d(1) - d(s): Image data	P49
BOX Area Bit Image Write	02h, 44h, DAD, 42h, a L, aH, sXL, sXH, sYL, sYH, d1...ds	Write bit image data to specified area. DAD : Display address aL : Bit image write start address lower byte aH : Bit image write start address upper byte sXL : Bit image write size X lower byte sXH : Bit image write size X upper byte sYL : Bit image write size Y lower byte sYH : Bit image write size Y upper byte d1...ds : Bit image data	P50
Specify Display start address	02H 44H DAD 53H aL aH sL sH d1...ds	Specify Display start address (Top left position of display screen) DAD:Display address aL: Display start address lower byte aH: Display start address upper byte	P50
Specify Display synchronous	02h,44h,DAD,57h, 01h	Operates synchronization with internal display refresh cycle.	P51
Brightness level setting	02H 44H DAD 58H n	Specify brightness level DAD: Display address n : Brightness level setting n=00H:0% n=01H:25% n=02H:50% n=03H:75% n=04H:100% n=10H:0% n=11H:12.5% n=12H:25% n=13H:37.5% n=14H:50% n=15H:62.5% n=16H:75% n=17H:87.5% n=18H:100%	P51

### 4.4.1 STX 44H DAD 46H aL aH sL sH d1...ds (Bit image write)

**Code:** 02H 44H DAD 46H aL aH sL sH d1...ds

DAD: Display address

aL: Bit image write address lower byte

aH: Bit image write address upper byte

sL: Bit image write size lower byte

sH: Bit image write size upper byte

d(1) - d(s): Image data (Refer to figure as follows)

Definable area:  $00H \leq DAD \leq FFH$

$0000H \leq (aL + aH \times 100H) \leq 0FFFH$

$0001H \leq (sL + sH \times 100H) \leq 1000H$

$(aL + aH \times 100h) + (sL + sH \times 100h) \leq 1000H$

$00H \leq d \leq FFH$

**Function:** Write bit image data to the write address specified.

If the Write address or Write size are defined to out of definable area, the

Command (STX to sH) is canceled, and wait until when receive next header (STX).

High speed DMA writing is processing from host to Display, Display memory when bit

image is written. Therefore, if a lot of data are written, display flickering may be

occurred.

If display flickering is occurred, interface timing “TDWR” should be taken little longer than Normal condition.

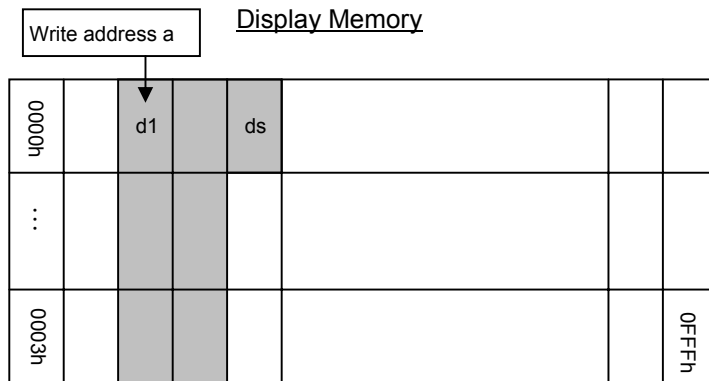

**4.4.2 STX 44H DAD 42H aL aH sXL sXH sYL sYH d1...ds (BOX Area Bit image write)**

**Code: 02H 44H DAD 42H aL aH sXL sXH sYL sYH d1...ds**

- DAD: Display address
- aL: Bit image write start address lower byte
- aH: Bit image write start address upper byte
- sXL: Bit image write size X lower byte
- sXH: Bit image write size X upper byte
- sYL: Bit image write size Y lower byte
- sYH: Bit image write size Y upper byte
- d(1) - d(s): Bit image data

Definable area:  $00H \leq DAD \leq FFH$   
 $0000H \leq (aL + aH * 100H) \leq 0FFFH$   
 $0000H \leq (sXL + sXH * 100H) \leq 03FFH$   
 $0000H \leq (sYL + sYH * 100H) \leq 0003H$   
 \*Both X size Y size must be within display memory size.  
 $00H \leq d \leq FFH$

Function: Write bit image data to specified specified area.

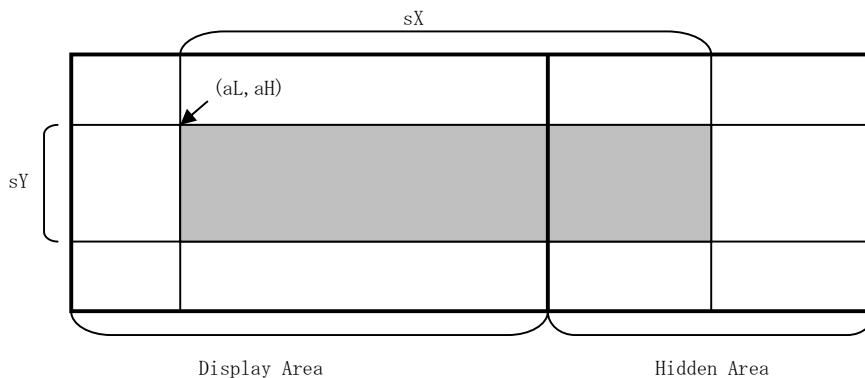

If the Write address and Write size are defined to out of definable area, the Command (STX to sH) is canceled, and wait until when receive next header (STX).

**4.4.3 STX 44H DAD 53H aL aH (Specify Display start address)**

**Code: 02H 44H DAD 53H aL aH**

- DAD: Display address
- aL: Display start address lower byte
- aH: Display start address upper byte

Definable area:  $00H \leq DAD \leq FFH$

$0000H \leq (aL + aH \times 100H) \leq 0FFFH$

Function: Specify Display start address (Top left position of display screen)

If the Display start address is defined to out of definable area, the Command is canceled. Smooth scroll display is possible combination with "Specify Display synchronization" command.

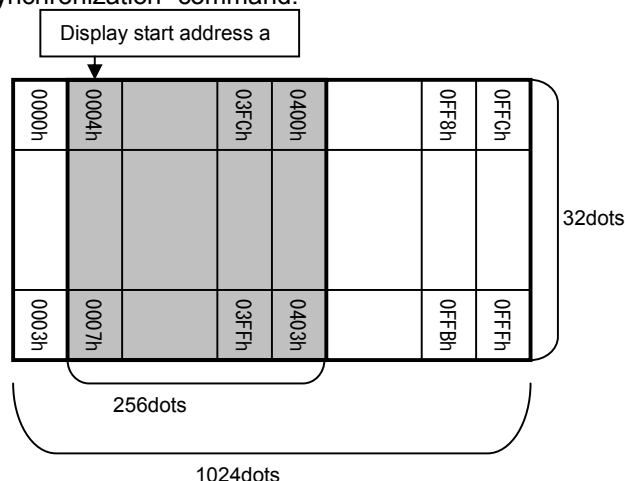

#### 4.4.4 STX 44H DAD 57H 01H (Specify Display synchronization)

Code: **02H 44H DAD 57H 01H**

DAD: Display address

Definable area:  $00H \leq DAD \leq FFH$

Default: n=04H or depending on Memory SW.

Function: Specify display synchronization with internal display refresh cycle.

Smooth scroll display is possible by using combination of this command and "Specify Display start address" command.

#### 4.4.5 STX 44H DAD 58H n (Brightness level setting)

Code: **02H 44H DAD 58H n**

DAD: Display address

n : Brightness level setting

Definable area:  $00H \leq DAD \leq FFH$

$00H \leq n \leq 04H, 10H \leq n \leq 18H$

Default: n=04H or depending on Memory SW.

Function: Specify brightness level of whole display screen.

n Level		n Level	
n	Brightness level	n	Brightness level
00H	0%	12H	25%
01H	25%	13H	37.5%
02H	50%	14H	50%
03H	75%	15H	62.5%
04H	100%	16H	75%
10H	0%	17H	87.5%
11H	12.5%	18H	100%

## 5 Setup

### 5.1 DIP-Switch (SW1)

SW No.	Function	Default
1	Display address select	Off
2		Off
3		Off
4		Off
5	Baud Rate select	Off
6	Command mode select	Off
7	Operating Mode select	Off
8	Protocol select	Off

#### 5.1.1 Display address select (Applying for Packet mode and Graphic DMA mode)

SW1	SW2	SW3	SW4	Address
OFF	OFF	OFF	OFF	Address 00H
ON	OFF	OFF	OFF	Address 01H
OFF	ON	OFF	OFF	Address 02H
ON	ON	OFF	OFF	Address 03H
OFF	OFF	ON	OFF	Address 04H
ON	OFF	ON	OFF	Address 05H
OFF	ON	ON	OFF	Address 06H
ON	ON	ON	OFF	Address 07H
OFF	OFF	OFF	ON	Address 08H
ON	OFF	OFF	ON	Address 09H
OFF	ON	OFF	ON	Address 0AH
ON	ON	OFF	ON	Address 0BH
OFF	OFF	ON	ON	Address 0CH
ON	OFF	ON	ON	Address 0DH
OFF	ON	ON	ON	Address 0EH
ON	ON	ON	ON	Address 0FH

#### 5.1.2 Baud rate select (Applying for RS-232 interface)

SW5	Baud rate
OFF	38,400bps
ON	19,200bps

#### 5.1.3 Command Mode select

SW6	Mode	
OFF	Normal command mode	Character, Graphic display mode
ON	Graphic DMA mode	High speed graphic display mode

#### 5.1.4 Operating Mode select

SW7	Mode	
OFF	Normal operation mode	Normal display operating mode
ON	Memory re-write mode	Memory re-write mode for Firmware, font, etc.

#### 5.1.5 Protocol mode select

SW8	Mode	
OFF	Direct mode	The module accepts all of data, the address setting by DIP SW on module is ignored.
ON	Packet mode	Data corresponding between the address of DIP SW and display address. (Note: If the address data is defined as FFH, all of modules cascaded accept the same data)

## 5.2 Memory SW

The module is operating with default value if the value defined by memory SW is out of valid area

Switch No.	Function	Valid area	Default
0	International font set	00H~0DH	00H
1	Character code type	00H~05H,10H~13H, FFH	00H
2	Horizontal scroll speed	00H~1FH	00H
3	Specify reverse display	00H,01H	00H
4	Specify write mixture display mode	00H~03H	00H
5	Brightness level of all display screen.	00H~04H,10H~18H	04H
6	Reserve	—	—
7	Write screen mode	00H,01H	00H
8	Font size	01H,02H,04H	01H
9	Specify-Cancel 2byte character mode	00H,01H	00H
10	Specify the character magnified display X	01H~04H	01H
11	Specify the character magnified display Y	01H~02H	01H
12	Character bold display	00H,01H	00H
13	Select 2byte character type	00H~03H	00H
14	Horizontal scroll quality select	00H,01H	00H
15	Reserve	—	—
16	Download character transfer at power-on (FROM >> RAM) 6x8dot	00H,01H	00H
17	Download character transfer at power-on (FROM >> RAM) 8x16dot	00H,01H	00H
18	Download character transfer at power-on (FROM >> RAM) 16x16dot	00H,01H	00H
19	FROM Macro execution at power-on (00H=Not execute)	00H~04H,81H~84H	00H
20	Reserve	—	—
21	Reserve	—	—
22	Reserve	—	—
23	Reserve	—	—
24	Reserve	—	—
25	Reserve	—	—
26	Reserve	—	—
27	Reserve	—	—
28	Reserve	—	—
29	Reserve	—	—
30	Reserve	—	—
31	Reserve	—	—

## Notice for the Cautious Handling VFD Modules

### Handling and Usage Precautions:

Please carefully follow the appropriate product application notes for proper usage, safety handling, and operation standards for maximum performance.

#### [VFD tubes are made of glass]

- Because the edges of the VFD glass-envelop are not smooth, it is necessary to handle carefully to avoid injuries to your hands
- Please avoid breaking the VFD glass-envelop to prevent injury from sharp glass particles.
- The tip of the exhaust pipe is fragile so avoid shock from impact.
- It is recommended to allow sufficient open space surrounding the exhaust pipe to avoid possible damage.
- Please design the PCB for the VFD-module within 0.3 mm warping tolerance to avoid any forces that may damage the display due to PCB distortion causing a breakdown of the electrical circuit leading to VFD failure.

#### [High voltage]

- Avoid touching conductive electrical parts, because the VFD-module uses high voltage exceeding 30~100 volts.
- Even when electric power is turned off, it may take more than one minute for the electrical current to discharge.

#### [Cable connection]

- Do not unplug the power and/or data cables of VFD-modules during operating condition because unrecoverable damage may result.
- Sending input signals to the VFD-module during a power off condition sometimes causes I/O port damage.
- It is recommended to use a 30 cm or shorter signal cable to prevent functional failures.

#### [Electrostatic charge]

- VFD-modules need electrostatic free packaging and protection from electrostatic charges during handling and usage.

#### [Structure]

- During operation, VFD and VFD-modules generate heat. Please consider sufficient heat radiation dissipation using heat sink solutions.
- We prefer to use UL grade materials or components in conjunction with VFD-modules.
- Wrap and twist motion causes stress and may break VFDs & VFD modules. Please adhere to allowances within 0.3mm at the point of attachment.

#### [Power]

- Apply regulated power to the VFD-module within specified voltages to protect from failures.
- Because some VFD-modules may consume in rush current equal to twice the typical current at power-on timing, we recommend using a sufficient power capability and quick starting of the power regulator.
- VFD-module needs a specified voltage at the point of connection. Please use an adequate power cable to avoid a decrease in voltage. We also recommend inserting a power fuse for extra protection.

#### [Operating consideration]

- Illuminating phosphor will decrease in brightness during extended operation. If a fixed pattern illuminates for an extended period,( several hours), the phosphor efficiency will decrease compared to the non operating phosphor causing a non uniform brightness among pixels. Please consider programming the display patterns to use all phosphor segments evenly. Scrolling may be a consideration for a period of time to refresh the phosphor condition and improve even illumination to the pixels.
- We recommend using a signal cable 30cm or less to avoid some possible disturbances to the signal.

#### [Storage and operating environment]

- Please use VFD-modules under the recommended specified environmental conditions. Salty, sulfur and dusty environments may damage the VFD-module even during storage.

#### [Discard]

- Some VFDs contain a small amount of cadmium in the phosphor and lead in the solder. When discarding VFDs or VFD-modules, please adhere to governmental related laws or regulations.

#### [Others]

- Although the VFD-module is designed to be protected from electrical noise, please plan your circuitry to exclude as much noise as possible.
- Do not reconstruct or repair the VFD-module without our authorization. We cannot assure the quality or reliability of unauthorized reconstructed VFD-modules.

### Notice:

- We do not authorize the use of any patents that may be inherent in these specifications.
- Neither whole nor partial copying of these specifications are permitted without our approval. If necessary , please ask for assistance from our sales consultant.
- This product is not designed for military, aerospace, medical or other life-critical applications. If you choose to use this product for these applications, please ask us for prior consultation or we cannot take responsibility for problems that may occur.

**Revision Note**

SPEC number	Date	Revision																																																							
DS-1016-0003-01	Aug. 29,2005	<p>Firmware version has been updated. Version No. : F33xB240 3.1.2 Character display Some of 16x32 dots international font has been revised. Font SPEC number : DS-874-0003-xx &gt;&gt; DS-874-0004-xx</p> <table border="1" data-bbox="625 573 1070 1048"> <thead> <tr> <th colspan="2" data-bbox="625 573 868 607">Font Set</th> <th colspan="2" data-bbox="868 573 1070 607">Character code</th> </tr> </thead> <tbody> <tr> <td colspan="2" data-bbox="625 607 868 689"></td> <td data-bbox="868 607 970 689">è→é</td> <td data-bbox="970 607 1070 689">ì→ï</td> </tr> <tr> <td data-bbox="625 689 767 857" rowspan="7">International font set ESC R n</td> <td data-bbox="767 689 868 719">n=1</td> <td data-bbox="868 689 970 719">7Bh</td> <td data-bbox="970 689 1070 719">----</td> </tr> <tr> <td data-bbox="767 719 868 748">n=5</td> <td data-bbox="868 719 970 748">60h</td> <td data-bbox="970 719 1070 748">----</td> </tr> <tr> <td data-bbox="767 748 868 777">n=6</td> <td data-bbox="868 748 970 777">5Dh</td> <td data-bbox="970 748 1070 777">----</td> </tr> <tr> <td data-bbox="767 777 868 806">n=9</td> <td data-bbox="868 777 970 806">60h</td> <td data-bbox="970 777 1070 806">----</td> </tr> <tr> <td data-bbox="767 806 868 835">n=10</td> <td data-bbox="868 806 970 835">60h</td> <td data-bbox="970 806 1070 835">----</td> </tr> <tr> <td data-bbox="767 835 868 864">n=11</td> <td data-bbox="868 835 970 864">5Eh</td> <td data-bbox="970 835 1070 864">----</td> </tr> <tr> <td data-bbox="767 864 868 893">n=12</td> <td data-bbox="868 864 970 893">5Eh</td> <td data-bbox="970 864 1070 893">----</td> </tr> <tr> <td data-bbox="625 893 767 1048" rowspan="7">Character code type ESC t n</td> <td data-bbox="767 893 868 922">n=0</td> <td data-bbox="868 893 970 922">82h</td> <td data-bbox="970 893 1070 922">8Bh</td> </tr> <tr> <td data-bbox="767 922 868 952">n=2</td> <td data-bbox="868 922 970 952">82h</td> <td data-bbox="970 922 1070 952">8Bh</td> </tr> <tr> <td data-bbox="767 952 868 981">n=3</td> <td data-bbox="868 952 970 981">82h</td> <td data-bbox="970 952 1070 981">----</td> </tr> <tr> <td data-bbox="767 981 868 1010">n=4</td> <td data-bbox="868 981 970 1010">82h</td> <td data-bbox="970 981 1070 1010">8Bh</td> </tr> <tr> <td data-bbox="767 1010 868 1039">n=5</td> <td data-bbox="868 1010 970 1039">82h</td> <td data-bbox="970 1010 1070 1039">8Bh</td> </tr> <tr> <td data-bbox="767 1039 868 1068">n=16</td> <td data-bbox="868 1039 970 1068">E9h</td> <td data-bbox="970 1039 1070 1068">EFh</td> </tr> <tr> <td data-bbox="767 1068 868 1097">n=18</td> <td data-bbox="868 1068 970 1097">82h</td> <td data-bbox="970 1068 1070 1097">----</td> </tr> <tr> <td data-bbox="767 1097 868 1126">n=19</td> <td data-bbox="868 1097 970 1126">82h</td> <td data-bbox="970 1097 1070 1126">8Bh</td> </tr> </tbody> </table> <p>4.4.2 BOX Area Bit Image Write has been added.</p>	Font Set		Character code				è→é	ì→ï	International font set ESC R n	n=1	7Bh	----	n=5	60h	----	n=6	5Dh	----	n=9	60h	----	n=10	60h	----	n=11	5Eh	----	n=12	5Eh	----	Character code type ESC t n	n=0	82h	8Bh	n=2	82h	8Bh	n=3	82h	----	n=4	82h	8Bh	n=5	82h	8Bh	n=16	E9h	EFh	n=18	82h	----	n=19	82h	8Bh
Font Set		Character code																																																							
		è→é	ì→ï																																																						
International font set ESC R n	n=1	7Bh	----																																																						
	n=5	60h	----																																																						
	n=6	5Dh	----																																																						
	n=9	60h	----																																																						
	n=10	60h	----																																																						
	n=11	5Eh	----																																																						
	n=12	5Eh	----																																																						
Character code type ESC t n	n=0	82h	8Bh																																																						
	n=2	82h	8Bh																																																						
	n=3	82h	----																																																						
	n=4	82h	8Bh																																																						
	n=5	82h	8Bh																																																						
	n=16	E9h	EFh																																																						
	n=18	82h	----																																																						
n=19	82h	8Bh																																																							
DS-1016-0003-02	Jan.16.2009	<p>1.1 Scope Applied firmware version has been corrected to F33xB24x.</p>																																																							