

# Dot Graphic VFD Module

# GU256x16M-K612C5

- 256 x 16 High Brightness Dot Graphic Display
- Single 12V DC Supply
- 2 ASCII Fonts (5 x 7 and 10 x 14)
- RS232 Asynchronous Serial Interface
- 31 Selectable Multi Drop Addresses
- Transformerless PSU (patent pending)
- Low Profile Construction

The module includes the VFD glass, VF drivers and microcontroller with refresh RAM, character generation, interface logic and patented transformerless DC/DC converter. The RS232 serial interface accepts 9600 or 19200 baud rates with optional parity bit. The module features a low profile design with numerous custom options available including special fonts and commands. Modules can be connected to a multi drop address system.

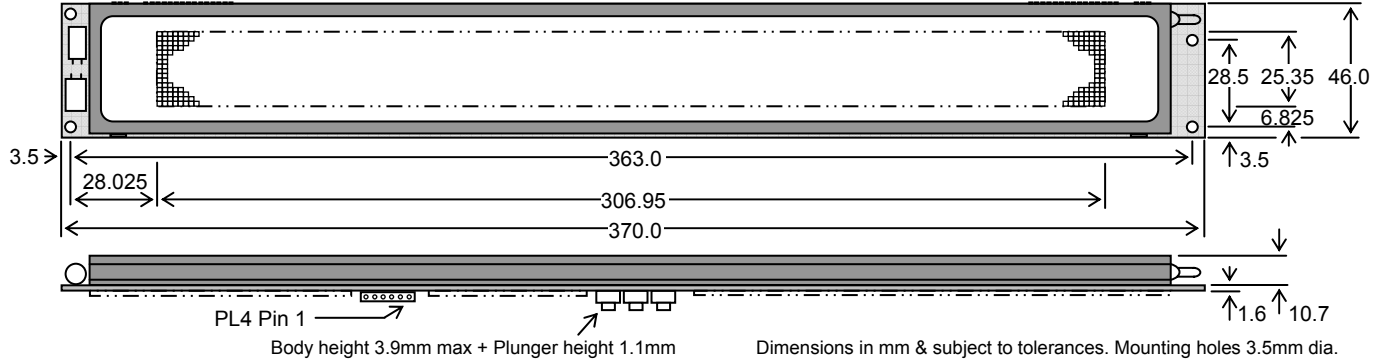

Dimensions in mm & subject to tolerances. Mounting holes 3.5mm dia.

## ELECTRICAL SPECIFICATION

Parameter	Symbol	Value	Condition
Supply Voltage	VDD	12.0VDC +/- 10%	GND=0V
Supply Current	IDD	440 mA typ.	VDD=12V
RS232 Input	VSIL / VSIH	-24V max / +24V max	VDD=12V
RS232 Output	VSOL/VSOH	-5VDC min / +5VDC min	VDD=12V

## OPTICAL & ENVIRONMENTAL SPECIFICATION

Parameter	Value
Display Area (X x Ymm)	306.95 x 25.35
Dot Size/Pitch (XxY mm)	0.95 x 1.35 / 1.2 x 1.6
Luminance	500 cd/m <sup>2</sup> (200 fL) Typ.
Colour of Illumination	Blue-Green (505nm)
Operating Temperature	-40°C to +85°C
Storage Temperature	-40°C to +85°C
Operating Humidity	20 to 85% RH @ 25°C

Optical filters can provide violet, red, yellow, blue & green output.

## SOFTWARE COMMANDS

Hex	Command
10	Software Reset to power on state
11	Write Mode toggles overwrite / scroll
12	Write Direction toggles increment / decrement
13	Display On/Off. Data is retained
14	Display Invert. Toggle negative image
15 + xx	Absolute Column Set from 00H - FFH
16 + xx	Relative Column Set by 00H - FFH
17 + len + data	Graphic Data Write 2 bytes per column, D7 top
18	Clear Character Buffer with 21 ASCII spaces
19 + data	Write to Character Buffer for display effect
1A + effect	Fade, wipe, scroll, dissolve & character delay
1B + 'L'	Font Large – select 10x14 font
1B + 'T'	Font Small Top – select 5x7 font for top half
1B + 'B'	Font Small Bottom – 5x7 font for bottom half
1C + macro + len + data	Store Macro E0H – FFH in EEPROM
1D + delay	Delay – pause for up to 3 seconds
1E + 1E + 1E + FE	Clear Macros from EEPROM
1E + 1E + 1E + FF	Stop Display and clear receive buffer
1E + 1E + 1E + adr	Address Select 00H – 1FH for active module
1F	Loop receive buffer
20 - DF	Character Write ASCII font. 10x14 default
E0 - FF	Run Macro – execute user defined macro
60 + dh + dl	Send Hexadecimal code instead of binary

The user can send non printable command codes 10H-1FH as hexadecimal by prefixing the code using character 60H. Example: `15`3F = Position column 64. When 1FH is sent, the commands/data in the communication buffer (max 192 bytes) are executed until 'Stop Display' is issued. Example: 10H --- data --- 1FH. Macro E0 is run at power on. Software and font sets are copyright Noritake Itron Corporation 2002

## CHARACTER SETS - 5X7 & 10X14 Font

	00	01	02	03	04	05	06	07	08	09	0A	0B	0C	0D	0E	0F
20	!	"	#	\$	%	&	'	(	)	*	+	,	-	.	/	
30	0	1	2	3	4	5	6	7	8	9	:	;	<	=	>	?
40	a	b	c	d	e	f	g	h	i	j	k	l	m	n	o	
50	p	q	r	s	t	u	v	w	x	y	z	[	\	]	~	
60	`	a	b	c	d	e	f	g	h	i	j	k	l	m	n	o
70	P	q	r	s	t	u	v	w	x	y	z	{		}	~	
80	E	°	f	l	l	o	r	s	e	n	θ	λ	π	τ	φ	ω
90	Σ	Ω	×	÷	°	°	°	°	°	°	°	°	°	°	°	°
A0	À	Á	Â	Ã	Ä	Å	Æ	Ç	È	É	Ê	Ë	Ì	Í	Î	Ï
B0	Ð	Ñ	Ò	Ó	Ô	Õ	Ö	×	Ø	Ù	Ú	Û	Ü	Ý	Þ	ß
C0	à	á	â	ã	ä	å	æ	ç	è	é	ê	ë	ì	í	î	ï
D0	ð	ñ	ò	ó	ô	õ	ö	÷	ø	ù	ú	û	ü	ý	þ	ÿ

Character 60H is used as a hexadecimal prefix, but can be displayed with a repeat send. Column position X = 00H – FFH. Address 'adr' = 00H - 1FH. Setting 'adr' to 00H activates all modules. Data is shown in hexadecimal and sent in binary. e.g. FFH = 11111111 Bin. The communication settings and address can be set using the three switches on the rear of the module. Default communication is Addr 00 - 9600,n,8,1 STD. Choose between 'STD' (standard) and 'WEB' modes. In 'WEB' mode 20H and all codes below 10H are ignored. To send a SPACE, 5FH can be used. All codes are accepted when sent using hexadecimal. Select 'WEB' mode when using the display with the Noritake Message Creator software.

## PL4

Pin	Signal	Description
1	VDD	12V Supply
2	RXD	RS232 received data
3	GND	0V supply
4	TXD	RS232 transmitted data
5	DTR	Module Busy if -5V
6	CTS	Host Busy if -5V

Handshaking lines DTR/CTS should be linked if not used. Received data is retransmitted from the module TXD output.

## CONTACT

**Noritake Sales Office Tel Nos**  
 Nagoya Japan: +81 (0)52-561-9867  
 Canada: +1-416-291-2946  
 Chicago USA: +1-847-439-9020  
 Munchen (D): +49 (0)89-3214-290  
 Itron UK: +44 (0)1493 601144  
 Rest Europe: +49 (0)61-0520-9220  
[www.noritake-iron.com](http://www.noritake-iron.com)

Detailed specification, software commands and interface timing are available on request. Subject to change without notice. IUK Doc. No. 10741 Iss.7 21Jan08

## SOFTWARE COMMANDS AND CHARACTER CONTROL CODES

Instruction	Hex	Description
Software Reset BUSY time = 500uS	10H	Resets the VFD module. The display's contents are cleared and the column position is set to 00H. The write mode is set to normal, the write direction is set to increment, the display is turned on, and the display invert is turned off. The 10x14-pixel font is selected.
Write Mode BUSY time = 300uS	11H	Toggles the write mode from normal write [default] to scroll write, and from scroll write to normal write.
Write Direction BUSY time = 300uS	12H	Toggles the writing direction from increment (left-to-right) to decrement (right-to-left), and from decrement to increment. The default direction is increment.
Display On/Off BUSY time = 300uS	13H	Toggles the display from On [default] to Off, and from Off to On.
Display Invert BUSY time = 300uS	14H	Inverts all data on the display.
Absolute Column Set BUSY time = 300uS	15H + xx	Sets the column position from 00H [default] to FFH.
Relative Column Set BUSY time = 300uS	16H + xx	Moves the current column position by xx amount. The column can be advanced by up to 255 pixels. Because the display's width is 256 pixels, it is possible to move the column position backwards as well as forward, e.g. 16H + FEH - moves the column position back by two.
Graphic Data Write BUSY time = 300uS	17H + len + data	Writes graphical data to the display from the current column position. If the write mode is set to scroll, the whole display is shifted one column to the left or right (dependant upon the current write direction). The graphical data length (width) must be sent prior to the data. Two bytes must be sent for each column, and must be in a vertical orientation, with bit 7 uppermost.
Character Buffer Clear BUSY time = 300uS	18H	Clears the internal 21-character buffer. This buffer is used in conjunction with the 'Display Effect' commands.
Character Buffer Write BUSY time = 300uS	19H + data	Write 21-characters to the internal buffer.
Display Effect For BUSY times see individual effect descriptions	1AH + effect	Produce a display effect: - 00H – Fade display from 'Off' to maximum brightness. 01H – Fade display from maximum brightness to 'Off'. 02H – Wipe display with the character buffer from left-to-right. 03H – Wipe display with the character buffer from right-to-left. 04H – Wipe display with the character buffer edge-to-center. 05H – Wipe display with the character buffer center-to-edge. 06H – Scroll display with the character buffer. 07H – Dissolve the display with the character buffer. 10H – 17H Set character delay (10H = No delay [default], 17H = Maximum delay)
Font Large BUSY time = 300uS	1BH + 'L'	Select the large 10x14-pixel font [default].
Font Small Top BUSY time = 300uS	1BH + 'T'	Select the small 5x7-pixel font, and write to the top half of the display.
Font Small Bottom BUSY time = 300uS	1BH + 'B'	Select the small 5x7-pixel font, and write to the bottom half of the display.
Macro Store BUSY times: - macro number = 10ms data byte = 5ms last data byte = 20ms	1CH+macro+len+data	Store a macro from E0H - FFH into non-volatile EEPROM. The first Macro (E0H), is always executed at power up. The Macro data length must be sent prior to the data itself. Up to 256 command/data bytes can be assigned to each macro, and 1900 bytes are available for all Macro definitions. All commands can be used in the Macros with the exception of 'Address Select', 'Macro Store', 'Macro Clear' and 'Macro Stop'. Please note that no provision is made for protecting previously defined Macros.
Delay BUSY time = 300uS	1DH + delay	Halts current processing for up to 3 seconds. Delay can be any value (00H - FFH) 55H = 1 second, AAH = 2 seconds, FFH = 3 seconds. (A value of 00H has no effect.)
Macro Clear BUSY time = 200ms	1EH+1EH+1EH+FEH	Clears all previously defined Macros.
Stop Display BUSY time = 300uS	1EH+1EH+1EH+FFH	This command stops any running Macro. All display commands will be ignored if any Macro is running. This command also stops 'Loop Receive Buffer' mode and clears the receive buffer.
Address Select BUSY time = 300uS	1FH+1EH+1EH + adr	Activate a display with address 'adr'. All displays have can have a defined address of 00H-1FH. If the display module's address is not the same, all data will be ignored with the exception of any new 'Address Select' commands. To activate all modules, set 'adr' to 00H.
Loop Receive Buffer BUSY time = 300uS	1FH	Activates a mode in which all commands/data present in the receive buffer up to the 1FH byte itself is executed. When the 1FH is reached, execution begins again from the start of the buffer. Sending the 'Stop Display' command ends this mode. The 'Stop Display' command should also be sent prior to sending any commands/data to be used with this mode to ensure that the receive buffer is empty.
Character Write BUSY time = 300uS	20H – DFH	Writes data direct to the display. The character write position is automatically advanced to the right or the left, depending upon the selected write direction. If the write mode is set to scroll, the display will scroll on the character from the left or right end.
Macro Run BUSY time = 300uS	E0H – FFH	Execute the user defined Macro, E0H = Macro 1, FFH = Macro 32.
Send Hex Byte BUSY times :- 1 <sup>st</sup> and 2 <sup>nd</sup> bytes = 300uS 3 <sup>rd</sup> byte = respective command / data busy	60H + dhH + dlH	Write to the display module using a 2-byte hexadecimal number. dhH = high nibble, dlH = low nibble. E.g. Sending `10 will reset the display.

Notes: When storing Macros definitions, the display may flicker. When erasing Macros, the display will momentarily go blank.  
To send 60H in binary form, the host must send twice, otherwise the module will interpret it has a hexadecimal prefix.

# Dot Graphic VFD Module

# GU256x16M-K612C5

## INTERFACING TO THE GU256x16M-K612C5

All communication to the VFD module is by the asynchronous serial interface. The factory default baud rate is set to 9600 with no parity. These settings can be changed with the 3 push switches on the back of the module and are retained in EEPROM. All received data is re-transmitted from the module TXD output. All data and command bytes (except macro store and macro clear commands) can be sent with no delay between the stop bit of one byte and the start bit of the following byte. This can sometimes cause display flicker but data and commands will still be received and processed correctly.

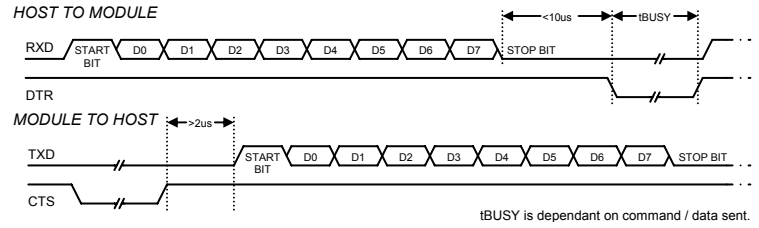
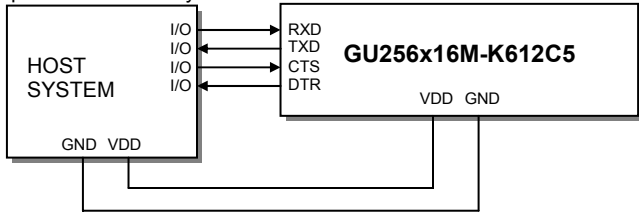
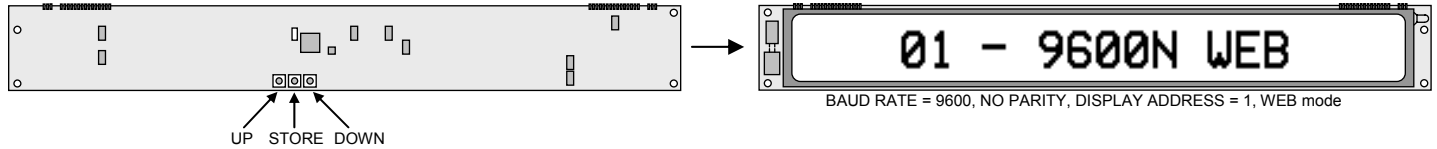

Fig1: Waveforms show RS232 asynchronous serial.

## COMMUNICATION SETTINGS

To change the communication settings, use the three push button switches on the rear of the module. First press the 'STORE' button to show the current settings, then on each 'UP' / 'DOWN' key press, the settings will change, and the user can fix the selected settings by pressing the 'STORE' button. The parity bit is changed first, 'N' indicates no parity and 'E' indicates even parity. The baud rate will next change, '19200' baud or '9600' baud. The next setting to change is the module 'Mode'. This can be 'STD' (standard) or 'WEB' mode. See details below. The last setting is the display address, this can be changed to one of 32 addresses. The display address is shown in hexadecimal.



## MODULE MODE (STANDARD or WEB)

The module can operate in one of two main modes, STD (standard) or WEB. In STD mode all data received are displayed / processed as normal. In WEB mode, the SPACE character (20H) and all codes below 10H are ignored. In this case the SPACE character can be displayed by one of two methods:- either use hexadecimal (\*20) or send character 5FH which is blank. The display must be in WEB mode when communication with the display is from a PC via the 'Generic / Text only' Windows™ printer driver (as used with Noritake Itron Message Creator web software).

## DISPLAY ORGANISATION

The display is organized as 256 2-byte columns (00H-FFH). All graphic data is written vertically, with the most significant bit uppermost.

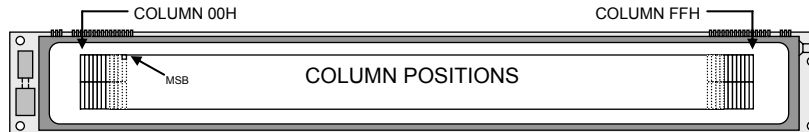

## DISPLAYING TEXT

Text can be sent direct to the display module. The column position is automatically advanced after each character is written. Using the 'Absolute Column Set' command (15H), the user can perform more accurate text positioning, allowing text to be placed on any of the 256 columns. Text is written from left to right, but can be reversed using the 'Write Direction' command.

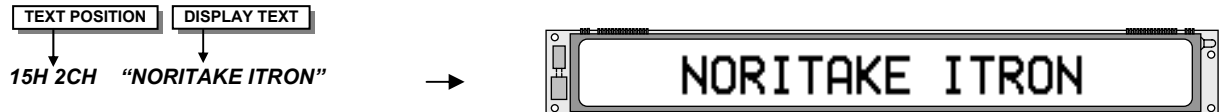

## SCROLLING TEXT

Character data can be scrolled onto the display from either the left or right edge. To scroll on a single screens worth of text, use the 'Character Buffer Write' command (19H) to download the text into the display module. Then use the 'Display Effect' command (1AH) to scroll on the text. The scroll direction can be set with the 'Write Direction' command (12H).

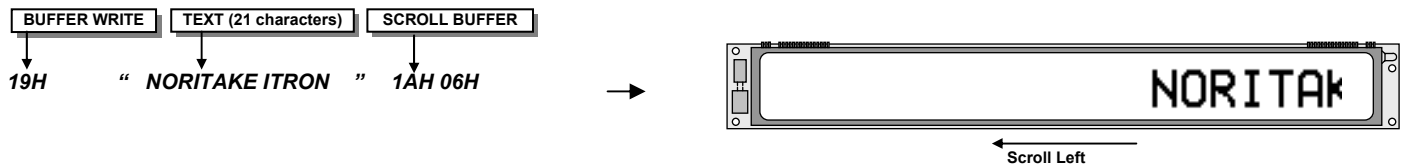

Using the 'Write Mode' command, the user can scroll longer text messages. Each character written to the display will scroll on from either the right or left side (depending upon the 'Write Direction').

## DISPLAY EFFECTS

The display provides a number of simple commands to enable a variety of effects to be achieved. Most of these work in conjunction with the internal 21 character buffer (10x14 font), where the text is first written to the buffer followed by the required display effect (see the scrolling text example above).

### Fade display up ( 1AH, 00H )

Increases the brightness of the display from OFF to maximum. The time taken for this operation is approx 0.5 sec.

### Fade display down ( 1AH, 01H )

Decreases the brightness of the display from maximum to OFF. The time taken for this operation is approx 0.5 sec.

### Wipe display with character buffer left to right ( 1AH, 02H )

Replaces the current contents of the display with the contents of the 21 character buffer one column at a time from the left to the right. The time taken for this operation is approx 1.6 sec.

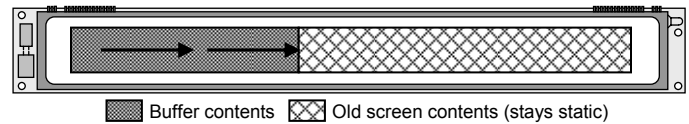

### Wipe display with character buffer right to left ( 1AH, 03H )

Replaces the current contents of the display with the contents of the 21 character buffer one column at a time from the right to the left. The time taken for this operation is approx 1.6 sec.

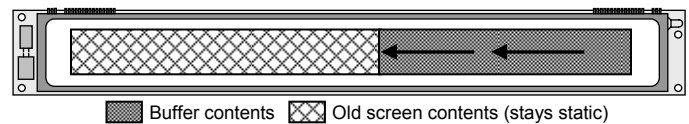

### Wipe display with character buffer edge to center ( 1AH, 04H )

Replaces the current contents of the display with the contents of the 21 character buffer on a column by column basis starting from the edges and ending in the center of the display. This can also be referred to as a 'curtain close' effect. The time taken for this operation is approx 1.6 sec.

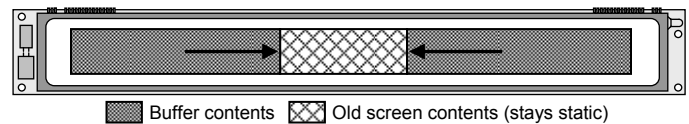

### Wipe display with character buffer center to edge ( 1AH, 05H )

Replaces the current contents of the display with the contents of the 21 character buffer on a column by column basis starting from the center and ending at the ends of the display. This can also be referred to as a 'curtain open' effect. The time taken for this operation is approx 1.6 sec.

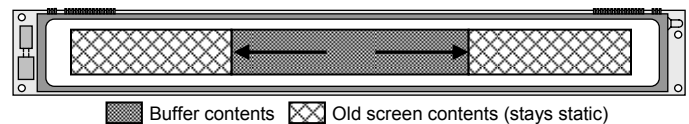

### Scroll display with character buffer ( 1AH, 06H )

Scrolls the contents of the 21 character buffer onto the display. The existing contents of the display are scrolled off. The default scroll direction is right to left but this can be toggled between right and left by issuing the 'Write Direction' command. The time taken for this operation is approx 1.6 sec.

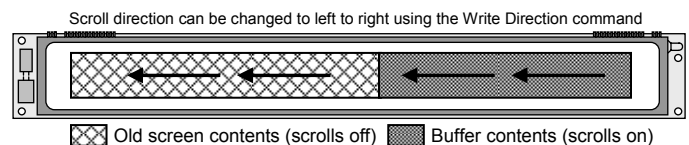

### Dissolve display with character buffer ( 1AH, 07H )

Replaces the current contents of the display with the contents of the 21 character buffer by changing just 1 pixel at a time. The position of the pixels changed is pseudo random and the visual effect is a dissolve from the old message to the new. The time taken for this operation is approx 1.6 sec.

### Character delay ( 1AH, 10H – 17H )

Defines the length of delay after a character is written in normal write mode. The possible values are No delay (10H – [default]), 25ms (11H), 50ms (12H), 100ms (13H), 150ms (14H), 200mS (15H), 250ms (16H) and 300ms (17H). With a character delay set, it is possible to send a string of characters to the display at full speed but the string will be displayed a character at a time with the specified time delay between each character. This frees up processing in the host by achieving the inter-character delay internally. Busy time = 300uS.

## WRITING GRAPHICAL DATA

A graphical image or icon can be placed in any column position. All graphical data is sent in a vertical format, with the top byte first and Bit 7 uppermost. The column position is automatically advanced after each pair of bytes. Graphical data can be scrolled onto the display by setting scroll mode using the 'Write Mode' command.

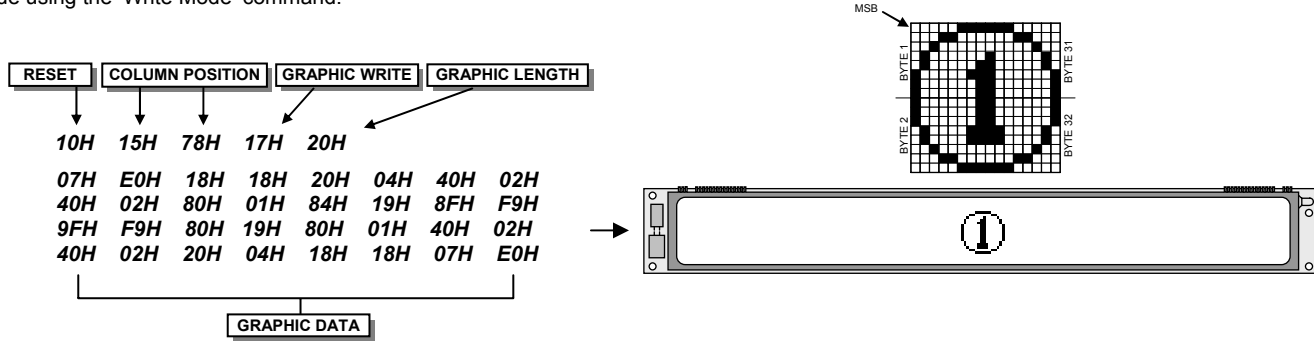

## DISPLAYING SMALL TEXT (5x7 font)

Small text, using the 5x7 font, can be sent to the display module. Use the 'Font Small Top' or 'Font Small Bottom' command to select the top or bottom row for displaying the text. Use one of the Column Set commands to specify which column the text is to be displayed. The column position is automatically advanced after each character is written. Text is written from left to right, but can be reversed using the 'Write Direction' command.

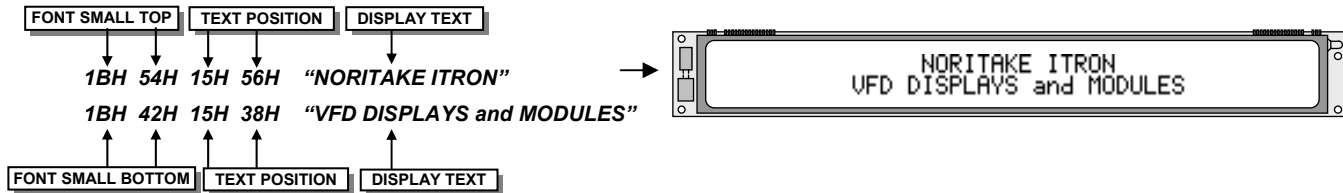

## USING MACROS

Commands and data can be stored in internal EEPROM by using the macros. Macro contents are retained in the display module even after power has been removed. There is provision for 32 macro's, one of which (E0H) is treated as a special case in that it is run at power on. Each macro can store up to 255 command / data bytes. There is a maximum of 1900 bytes available for all macros. Once a macro has been defined using the Macro Store command, it can be run by sending the macro number (E0H – FFH). A running macro is stopped by sending the Stop Display command. To make a macro repeat indefinitely, ensure that the last byte in the definition is the code of that macro. It is also possible to call a macro from within another macro definition. Nesting can not however go any deeper than 1 level.

**Macro example 1:-** Define a macro to flash the message 'ERROR' in the center of the display indefinitely at 1Hz. This macro will run at power on.

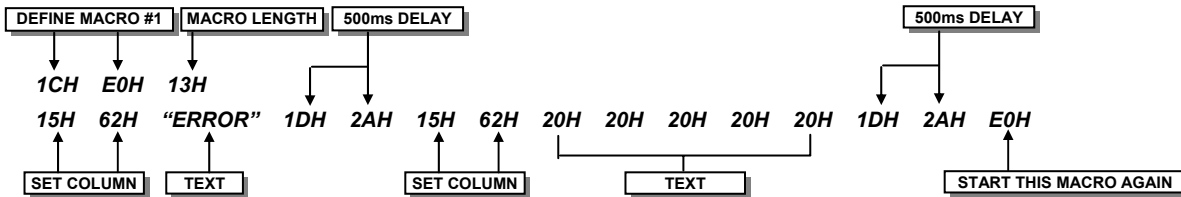

**Macro example 2:-** Scrolling a message.

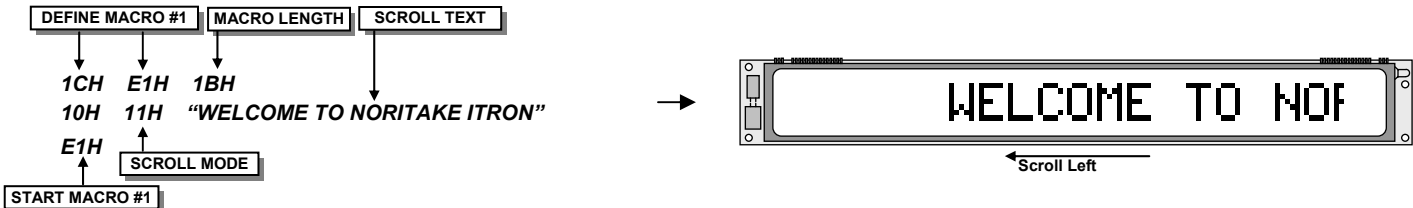

## LOOP RECEIVE BUFFER

The display has a 192 byte first in first out (FIFO) receive buffer. Commands / data that have been sent to the module can be processed again and again using the 'Loop Receive Buffer' command. In order for this to work correctly, the buffer needs to be cleared first using the 'Stop Display' command. Then the required sequence of commands / data is sent. Finally the 'Loop Receive Buffer' command is sent. Sending 'Stop Display' again stops the sequence.

**Loop example** :- Flash the message 'ERROR' in the center of the display indefinitely at 1Hz. This has the same effect as Macro example 1 above.

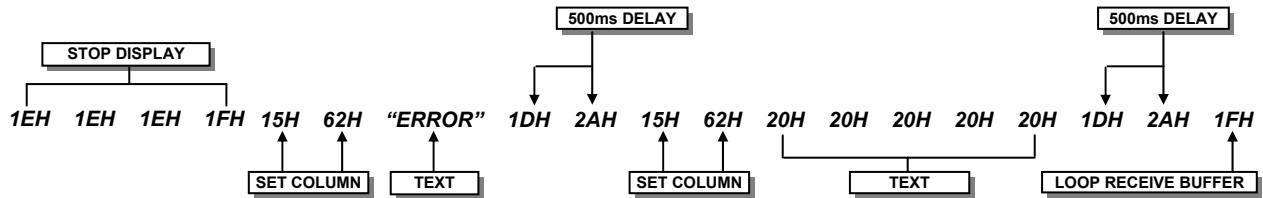

## MULTI DROP ADDRESSING

It is possible to connect up to 31 display modules to the same host. Each module can be set to have a unique address (see details in 'Communication Settings' section). Any module set to have address 00H will receive and process all data. In order for a module with an address other than 00H to accept data, the host must first send an 'Address Select' command with 'adr' specifying the address of the module to send the data to. If the 'Address Select' command is sent with 'adr' set to 00H, all modules process the data that follows irrelevant of their address.

**Addressing example** :- A system comprising 3 display modules connected to one host system.

Module 1 is set to '01 - 9600N STD'.

Module 2 is set to '02 - 9600N STD'.

Module 3 is set to '03 - 9600N STD'.

To display 'Call 0 for attention' on module 1 : 1EH 1EH 1EH 01H 10H 15H 08H "Call 0 for attention"

To display 'Welcome to Noritake!' on module 2 : 1EH 1EH 1EH 02H 10H 15H 08H "Welcome to Noritake!"

To display 'Stores/Goods In' on module 3 : 1EH 1EH 1EH 03H 10H 15H 26H "Stores/Goods In"

Then to display '!! Evacuate !!' on all modules : 1EH 1EH 1EH 00H 10H 15H 2CH "!! Evacuate !!"



## Module connections :-

As all data received at a module's RXD input is retransmitted from its TXD output, in the above example the modules are daisy chained together so that the TXD output of one module is connected to the RXD input of the following one. In this example, handshaking is used so the DTR / CTS lines are daisy chained in a similar fashion. The system can be simplified by not using the handshaking lines at all but care must be taken by the host not to fill the display module(s) communication buffer in which case data can be lost. An even simpler solution would be to just use the TX output of the host and connect this to all the module RXD lines. This solution enables each module to be connected using just 3 wires (VCC, RXD and GND). The disadvantage of this (in addition to the lack of handshaking) is that the host RS232 driver must be capable of driving the number of displays (RXD inputs) in the system.