

# GU85T03

## N-CHANNEL ENHANCEMENT MODE POWER MOSFET

BVDSS	30V
RDS(ON)	6mΩ
ID	75A

### Description

The GU85T03 provide the designer with the best combination of fast switching, ruggedized device design, low on-resistance and cost-effectiveness.

The TO-263 package is universally preferred for all commercial-industrial surface mount applications and suited for low voltage applications such as DC/DC converters.

### Features

- \*Low Gate Charge
- \*Simple Drive Requirement
- \*Fast Switching Speed
- \*RoHS Compliant

### Package Dimensions

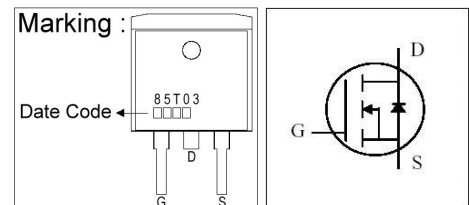
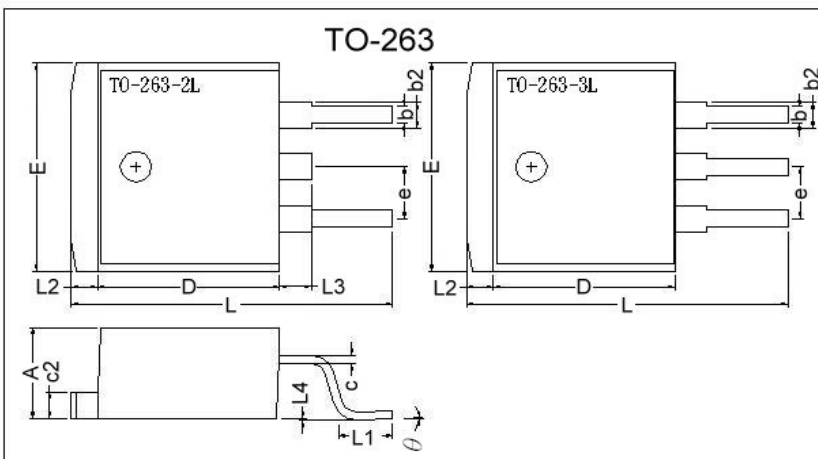

REF.	Millimeter		REF.	Millimeter	
	Min.	Max.		Min.	Max.
A	4.40	4.80	c2	1.25	1.45
b	0.76	1.00	b2	1.17	1.47
L4	0.00	0.30	D	8.6	9.0
c	0.36	0.5	e	2.54 REF.	
L3	1.50 REF.		L	14.6	15.8
L1	2.29	2.79	θ	0°	8°
E	9.80	10.4	L2	1.27 REF.	

### Absolute Maximum Ratings

Parameter	Symbol	Ratings	Unit
Drain-Source Voltage	$V_{DS}$	30	V
Gate-Source Voltage	$V_{GS}$	±20	V
Continuous Drain Current, $V_{GS}@4.5V$	$I_D @T_C=25^{\circ}C$	75	A
Continuous Drain Current, $V_{GS}@4.5V$	$I_D @T_C=100^{\circ}C$	55	A
Pulsed Drain Current <sup>1</sup>	$I_{DM}$	350	A
Total Power Dissipation	$P_D @T_C=25^{\circ}C$	107	W
Linear Derating Factor		0.7	W/°C
Operating Junction and Storage Temperature Range	$T_j, T_{stg}$	-55 ~ +175	°C

### Thermal Data

Parameter	Symbol	Value	Unit
Thermal Resistance Junction-case Max.	$R_{thj-c}$	1.4	°C/W
Thermal Resistance Junction-ambient Max.	$R_{thj-a}$	62	°C/W

**Electrical Characteristics (T<sub>j</sub> = 25°C unless otherwise specified)**

Parameter	Symbol	Min.	Typ.	Max.	Unit	Test Conditions
Drain-Source Breakdown Voltage	BV <sub>DSS</sub>	30	-	-	V	V <sub>GS</sub> =0, I <sub>D</sub> =250uA
Breakdown Voltage Temperature Coefficient	$\Delta BV_{DSS} / \Delta T_j$	-	0.018	-	V/°C	Reference to 25°C, I <sub>D</sub> =1mA
Gate Threshold Voltage	V <sub>GS(th)</sub>	1.0	-	3.0	V	V <sub>DS</sub> =V <sub>GS</sub> , I <sub>D</sub> =250uA
Forward Transconductance	g <sub>fs</sub>	-	32	-	S	V <sub>DS</sub> =10V, I <sub>D</sub> =30A
Gate-Source Leakage Current	I <sub>GSS</sub>	-	-	±100	nA	V <sub>GS</sub> = ±20V
Drain-Source Leakage Current(T <sub>j</sub> =25°C)	I <sub>DSS</sub>	-	-	1	uA	V <sub>DS</sub> =30V, V <sub>GS</sub> =0
Drain-Source Leakage Current(T <sub>j</sub> =175°C)		-	-	500	uA	V <sub>DS</sub> =24V, V <sub>GS</sub> =0
Static Drain-Source On-Resistance <sup>2</sup>	R <sub>DS(ON)</sub>	-	-	6	mΩ	V <sub>GS</sub> =10V, I <sub>D</sub> =45A
		-	-	10		V <sub>GS</sub> =4.5V, I <sub>D</sub> =30A
Total Gate Charge <sup>2</sup>	Q <sub>g</sub>	-	33	52	nC	I <sub>D</sub> =30A V <sub>DS</sub> =24V V <sub>GS</sub> =4.5V
Gate-Source Charge	Q <sub>gs</sub>	-	7.5	-		
Gate-Drain ("Miller") Charge	Q <sub>gd</sub>	-	24	-		
Turn-on Delay Time <sup>2</sup>	T <sub>d(on)</sub>	-	11.2	-	ns	V <sub>DS</sub> =15V I <sub>D</sub> =30A V <sub>GS</sub> =10V R <sub>G</sub> =3.3Ω R <sub>D</sub> =0.5Ω
Rise Time	T <sub>r</sub>	-	77	-		
Turn-off Delay Time	T <sub>d(off)</sub>	-	35	-		
Fall Time	T <sub>f</sub>	-	67	-		
Input Capacitance	C <sub>iss</sub>	-	2700	4200	pF	V <sub>GS</sub> =0V V <sub>DS</sub> =25V f=1.0MHz
Output Capacitance	C <sub>oss</sub>	-	550	-		
Reverse Transfer Capacitance	C <sub>rss</sub>	-	380	-		

**Source-Drain Diode**

Parameter	Symbol	Min.	Typ.	Max.	Unit	Test Conditions
Forward On Voltage <sup>2</sup>	V <sub>SD</sub>	-	-	1.3	V	I <sub>S</sub> =45A, V <sub>GS</sub> =0V
Reverse Recovery Time <sup>2</sup>	T <sub>rr</sub>	-	28	-	ns	I <sub>S</sub> =30A, V <sub>GS</sub> =0V di/dt=100A/μs
Reverse Recovery Charge	Q <sub>rr</sub>	-	10	-	nC	

Notes: 1. Pulse width limited by safe operating area.

2. Pulse width ≤ 300us, duty cycle ≤ 2%.

## Characteristics Curve

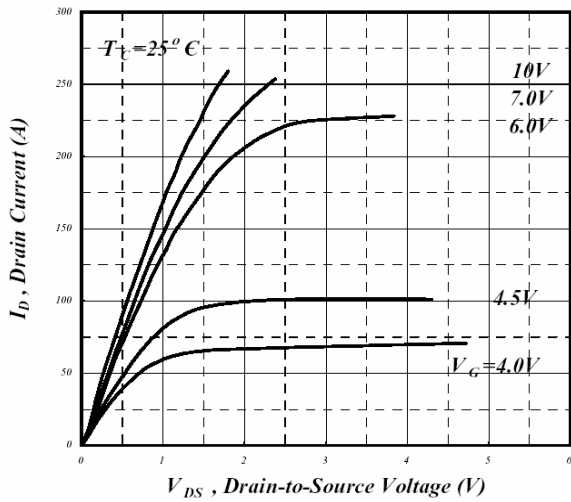

**Fig 1. Typical Output Characteristics**

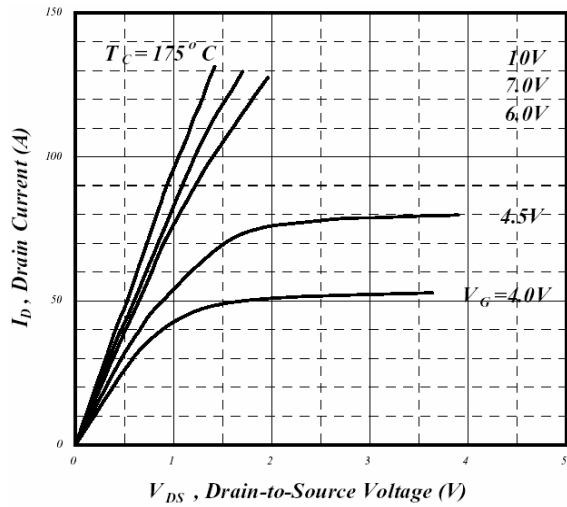

**Fig 2. Typical Output Characteristics**

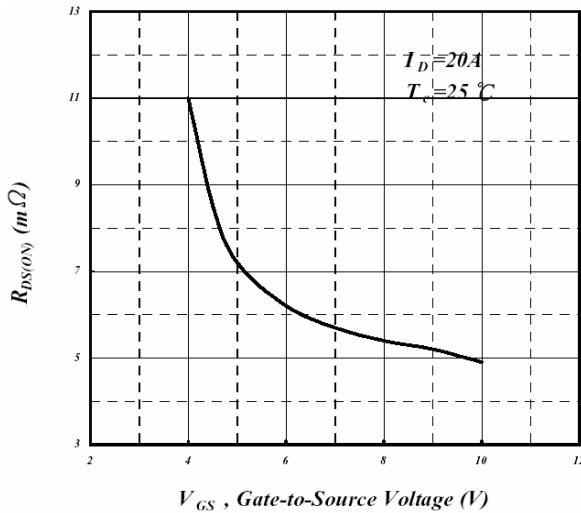

**Fig 3. On-Resistance v.s. Gate Voltage**

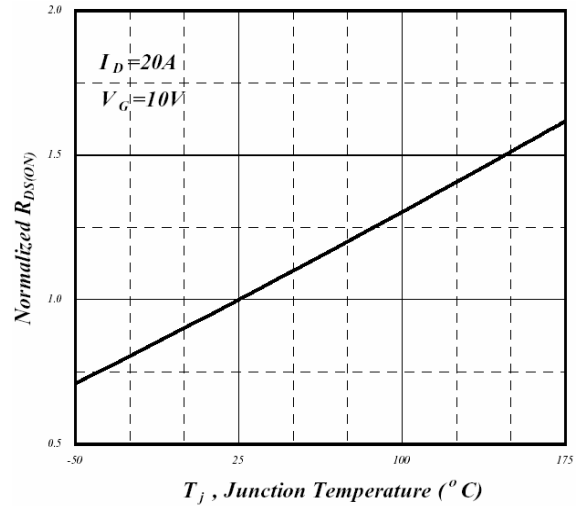

**Fig 4. Normalized On-Resistance v.s. Junction Temperature**

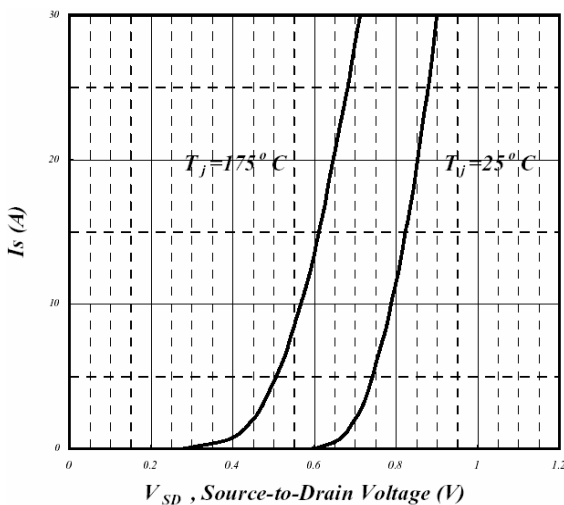

**Fig 5. Forward Characteristics of Reverse Diode**

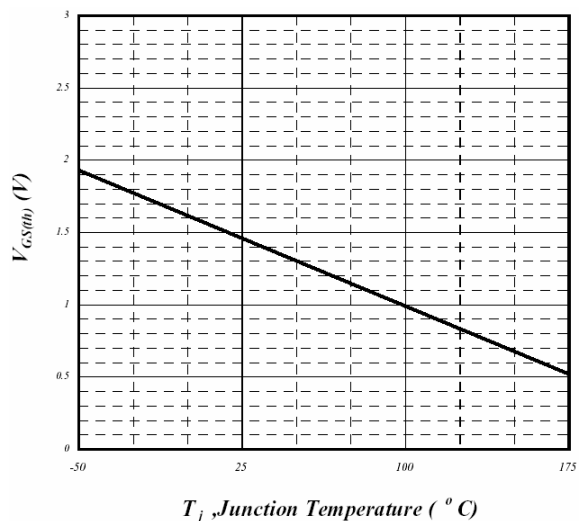

**Fig 6. Gate Threshold Voltage v.s. Junction Temperature**

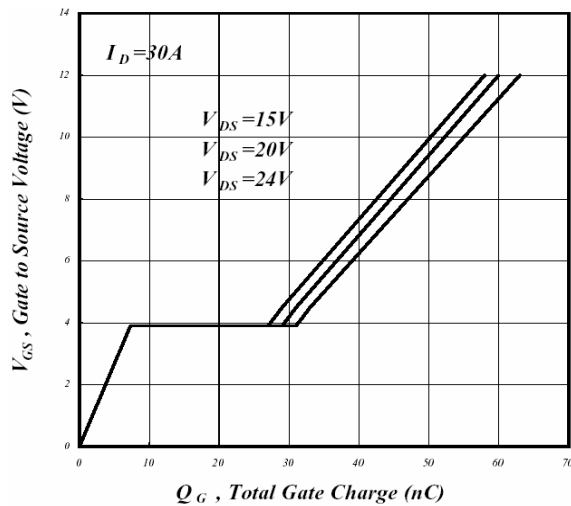

**Fig 7. Gate Charge Characteristics**

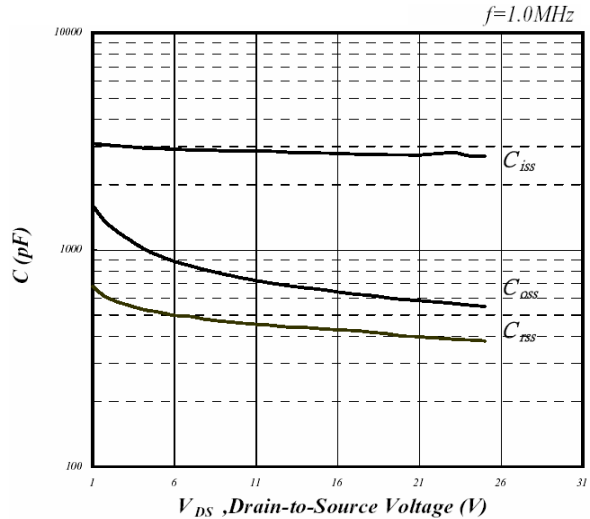

**Fig 8. Typical Capacitance Characteristics**

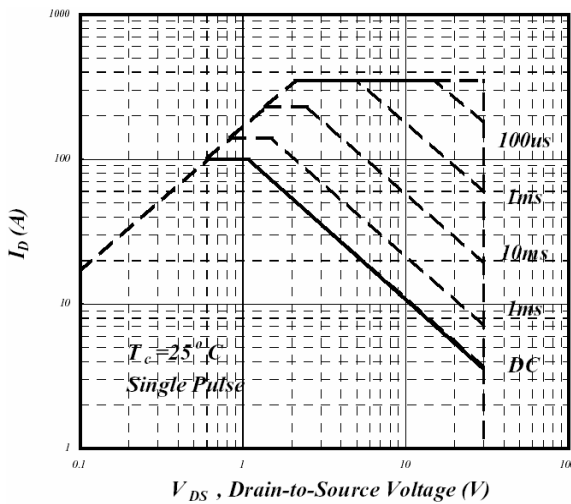

**Fig 9. Maximum Safe Operating Area**

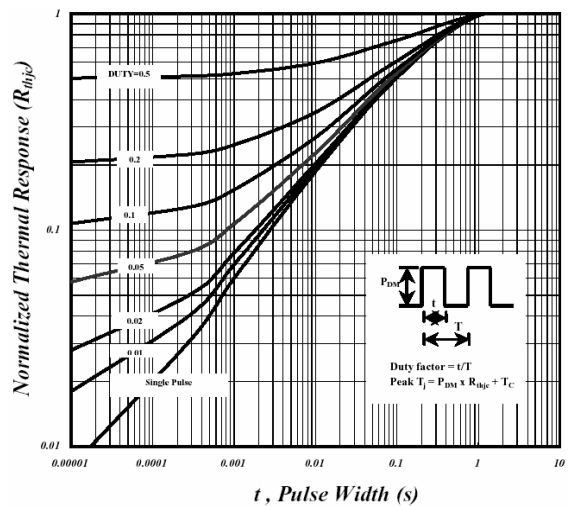

**Fig 10. Effective Transient Thermal Impedance**

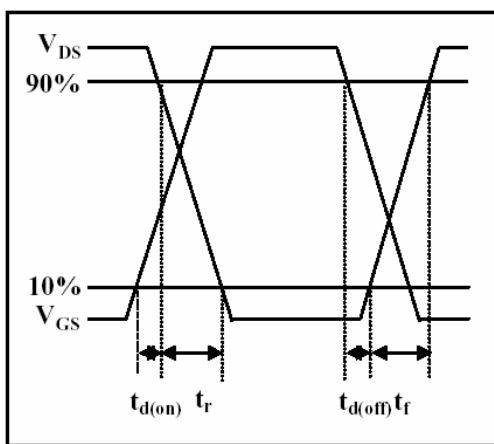

**Fig 11. Switching Time Waveform**

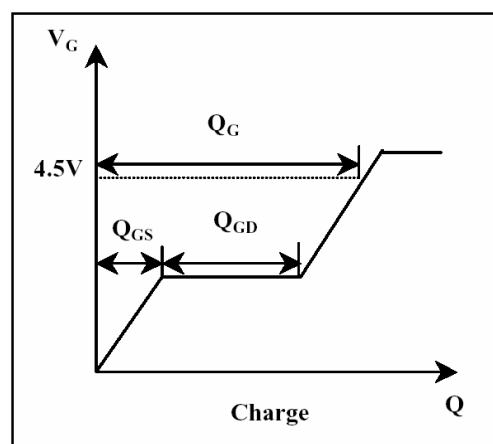

**Fig 12. Gate Charge Waveform**

**Important Notice:**

- All rights are reserved. Reproduction in whole or in part is prohibited without the prior written approval of GTM.
- GTM reserves the right to make changes to its products without notice.
- GTM semiconductor products are not warranted to be suitable for use in life-support Applications, or systems.
- GTM assumes no liability for any consequence of customer product design, infringement of patents, or application assistance.

**Head Office And Factory:**

- Taiwan:** No. 17-1 Tatung Rd. Fu Kou Hsin-Chu Industrial Park, Hsin-Chu, Taiwan, R. O. C.
- TEL : 886-3-597-7061 FAX : 886-3-597-9220, 597-0785
- China:** (201203) No.255, Jang-Jiang Tsai-Lueng RD. , Pu-Dung-Hsin District, Shang-Hai City, China
- TEL : 86-21-5895-7671 ~ 4 FAX : 86-21-38950165