

---

### Description

The GXB5205 is a 12-channel GPS (Global Positioning System) receiver module. This small module includes all the functions required for GPS and a passive antenna and is ideal for use in various types of portable applications as well as automotive system.

---

### Features

- ◆ Implementation of Sony CXD2951 single chip GPS
- ◆ 12-channel GPS receiver capable of simultaneously receiving 12 satellites
- ◆ All-in-view measurement
- ◆ Tracking sensitivity : -150dBm (typ.)
- ◆ Acquisition sensitivity : -136dBm (typ.)
- ◆ Time to first fix (time until initial measurement after power-on) (Typ., Open sky)
  - Cold start (without ephemeris and almanac) : 50s
  - Warm start (without ephemeris with almanac) : 35s
  - Hot start (with ephemeris and almanac) : 3s
- ◆ Positioning accuracy (Open air with  $\geq -130\text{dBm}$ , PDOP  $\leq 2.0$ )
  - Stand alone (GPS unit only) 2DRMS: < 3m
- ◆ Communication method
  - Supports NMEA-0183 version 3.01
- ◆ 1PPS output
- ◆ Current consumption : Acquisition (typ.): 74mA  
: Tracking (typ.): 45mA
- ◆ Module size (typ.) : 35 (W)  $\times$  34.5 (D)  $\times$  7.95 (H) [mm]
- ◆ Datum : WGS-84
- ◆ Follow-up performance : Velocity : 500km/h or less  
: Acceleration : 1G or less
- ◆ Antenna element : NTK
- ◆ Interface connector : FMN (side-entry, 1mm pitch), flat cable

Sony reserves the right to change products and specifications without prior notice. This information does not convey any license by any implication or otherwise under any patents or other right. Application circuits shown, if any, are typical examples illustrating the operation of the devices. Sony cannot assume responsibility for any problems arising out of the use of these circuits.

Block Diagram

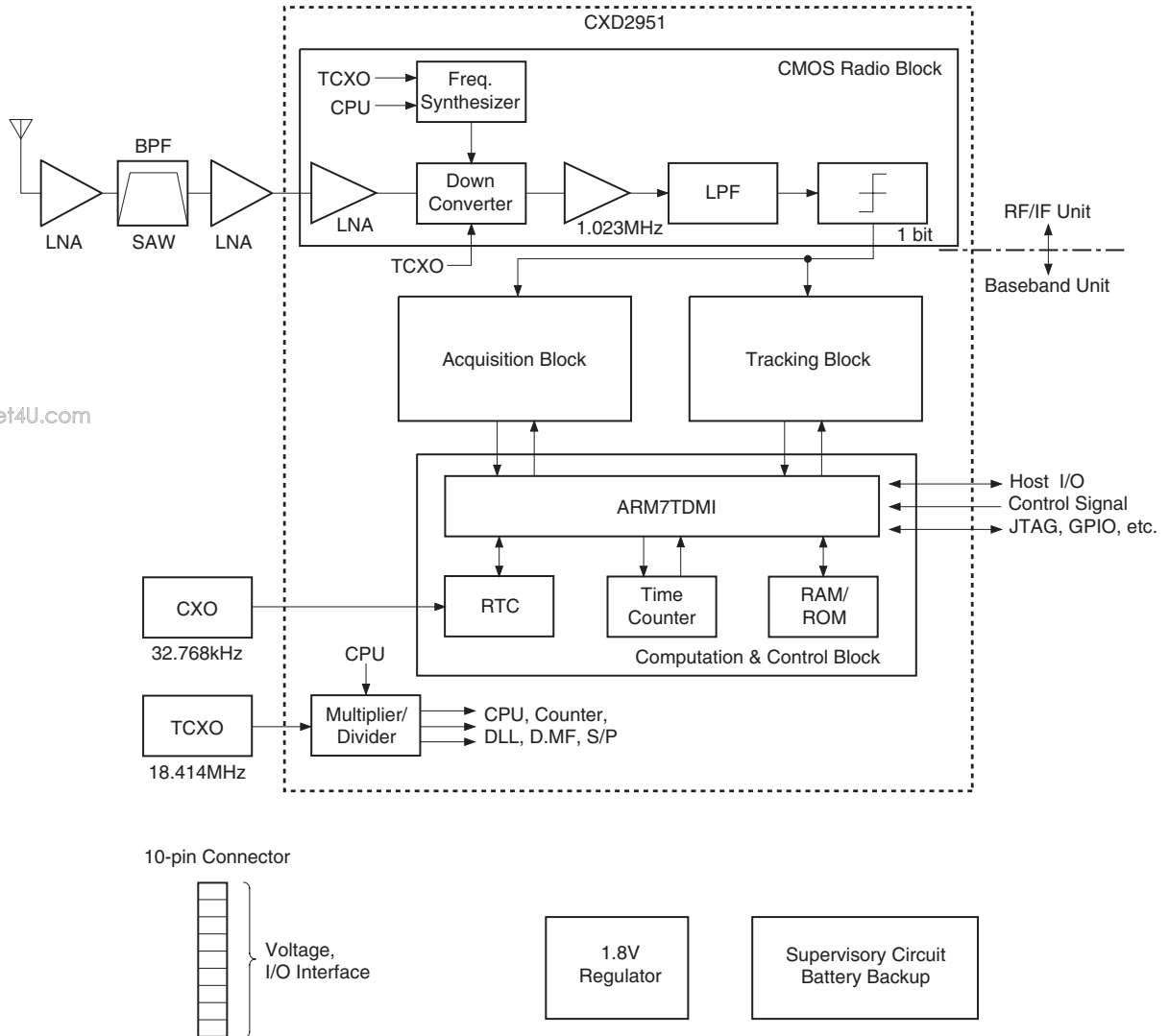

www.DataSheet4U.com

Sony provides all necessary components for GPS location estimations with the GXB5205 module. The only other requirements are voltage and RS232 receiving capability to capture the position outputs. The module is small and compact to fit into most applications. For the best results, the module should be placed with the antenna faced towards open sky to capture as much visible satellites as possible.

## Pin Description

Pin No.	Symbol	I/O	Description
1	TXD0	O	UART(CH0) transmission data
2	RXD0	I	UART(CH0) reception data
3	1PPS	O	1PPS output
4	BR1	I	Baud rate setting 1
5	BR0	I	Baud rate setting 0
6	RESET	I	Hardware reset (Low active)
7	DGND		Digital GND
8	VDD		Power supply 3.4V
9	BATT		Battery backup 2.8V
10	AGND		Analog GND

www.DataSheet4U.com

## Operating Conditions

Item	Symbol	Min.	Typ.	Max.	Unit
Supply voltage	VDD	3.1	3.4	3.7	V
Supply voltage ripple	Vcc			50	mVp-p
Backup battery voltage	Vbat	2.6	2.8	3.0	V
Input pin voltage	VIN	-0.3		5.5	V
Supply current: Acquisition (25°C)	Icc		74		mA
Supply current: Tracking (25°C)	Icc		45		mA
Standby current	Istdby		10	120	μA
Operating temperature	Topr	-40	+25	+85	°C
Reception frequency, L1 CA code	FIN		1575.42		MHz

## Operating Instructions

1. Install 10-pin receiving connector with the pin-out connection above.
2. Place the GXB5205 with the antenna faced towards open sky.
3. Apply 3.4V supply voltage to the module.
4. Install GPS View or NMEA-0183 GPS monitoring software.
5. Open serial port on application to receive messages from the GXB5205.
6. Wait for required TTFF to acquire a position fix.

## Baud Rate Setting

Baud rate	BR1	BR0
4800	Open (L)	H
9600	Open (L)	Open (L)
19200	H	Open (L)
38400	H	H

## Electrical Characteristics

### Absolute Maximum Ratings

www.DataSheet4U

Item	Symbol	Min.	Max.	Unit
Supply voltage	V <sub>DD</sub>	-0.5	3.7	V
Input voltage	V <sub>I</sub>	-0.5	5.5	V
Output voltage	V <sub>O</sub>	-0.5	V <sub>DD</sub> + 0.5	V
Operating temperature	T <sub>opr</sub>	-40	+85	°C
Storage temperature	T <sub>stg</sub>	-40	+105	°C

### DC Characteristics

(T<sub>a</sub> = -40 to +85°C)

Item	Symbol	Condition	Min.	Typ.	Max.	Unit	Pins
Supply voltage	V <sub>DD</sub>		3.1	3.4	3.7	V	8
	BATT		2.6	2.8	3.0	V	9
Supply voltage ripple	V <sub>DD</sub>				50	mVp-p	8
Input voltage	H level	V <sub>IH</sub>	2.0		5.5	V	2, 3, 4, 5, 6
	L level	V <sub>IL</sub>	-0.3		0.8	V	
Output voltage	H level	V <sub>OH</sub>	I <sub>OH</sub> = -8mA	2.4		V	1
	L level	V <sub>OL</sub>	I <sub>OL</sub> = 2mA		0.4	V	
Current consumption	V <sub>DD</sub> (3.3V)	Acquisition		74		mA	8
		Tracking		45			
	BATT	V <sub>batt</sub> = 2.8V		10	120	μA	9

**AC Characteristics**

(Ta = 25°C)

Item	Symbol	Condition	Min.	Typ.	Max.	Unit
C/N output value	CN	-130dBm input, tracking *1		41		dB
TCXO frequency	Ftcxo	Internal		18.414		MHz
Message latency	TI				1.0	s
RF gain	Grf			125		dB
Noise figure	NF			10		dB
Output signal rise time	Ttlh	Zload = 5kΩ, 20pF		25	55	ns
Output signal fall time	Tthl	Zload = 5kΩ, 20pF		30	60	ns

\*1 Using SONY evaluation software "GPS View"

www.DataSheet4U.com

**Timing of Output Signal**

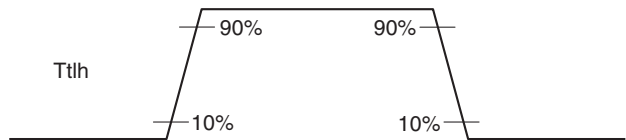
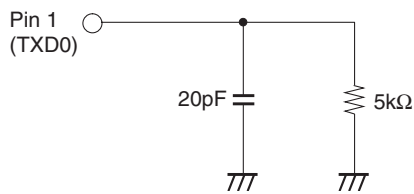

**UART Interface**

Interface: Asynchronous serial interface (UART)  
 Baud rate: 4800bps/9600bps/19200bps/38400bps  
 Start bit: 1 bit  
 Data bit: 8 bits  
 Stop bit: 1 bit  
 Parity bit: None  
 Flow control: Xon/Xoff  
 Data output cycle: Approximately 1 second (default)

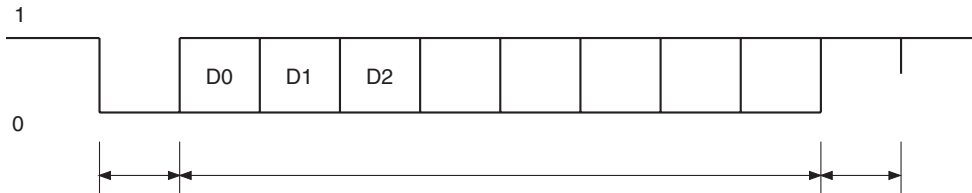

www.DataSheet4U.com

**NMEA-0183 Format**

The GXB5205 can output 8 different types of sentence: GPGGA, GPGLL, GPGSA, GPGSV, GPRMC, GPVTG, GPZDA and PSGSA. If 9600bps or 19200bps or 38400bps baud rate is set for port setting, it outputs 7 types of sentence: GPGGA, GPGSA, GPGSV, GPRMC, GPVTG, GPZDA, PSGSA as default. Moreover, if 4800bps baud rate is set, it outputs 4 types of sentences: GPGGA, GPGSA, GPGSV, GPRMC as default.

**Initialization**

The GXB5205 has a reset pin (Pin 6) and normally this pin should be left open. The GXB5205 can perform the power-on reset operation only by turning on or off the power supply pin (Pin 8). In addition, when configuring the component in order to realize the reset from the system side during operation, connect the reset pin to the external circuit. The following setting enables the reset.

**1. When turning the power on (Power-on reset)**

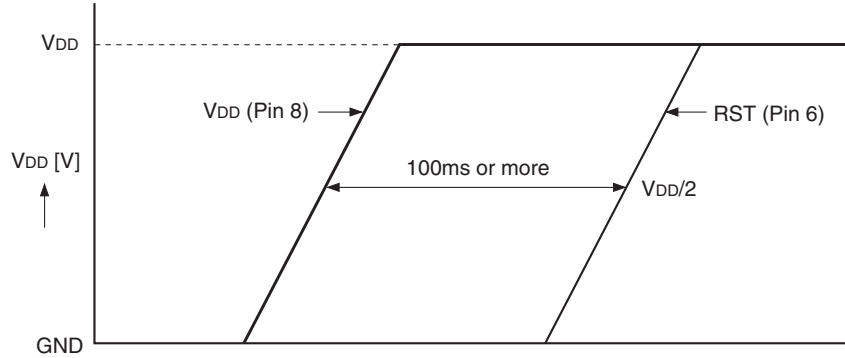

www.DataSheet4U.com

When applying the power supply to the power supply pin (Pin 8), set the reset pin (Pin 6) Low in advance, and set it High 100ms after power-on.

**2. Initialization during operation**

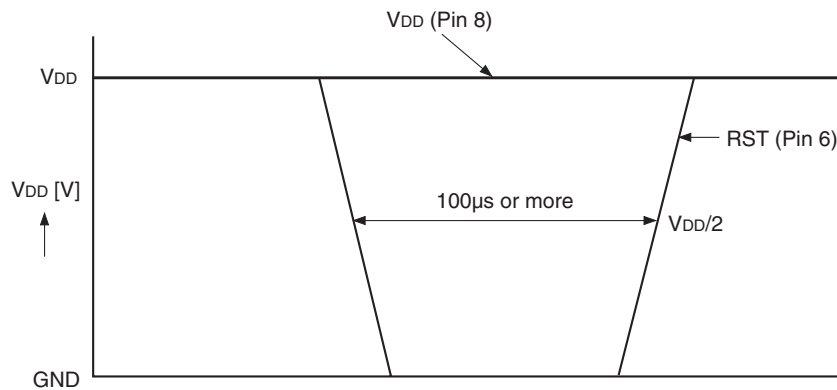

When performing the reset while the reset pin (Pin 6) is High, keep it Low for 100µs or more before setting High.

**NMEA Message Output Timing**

NMEA messages are output within 1s after the 1PPS pulse.

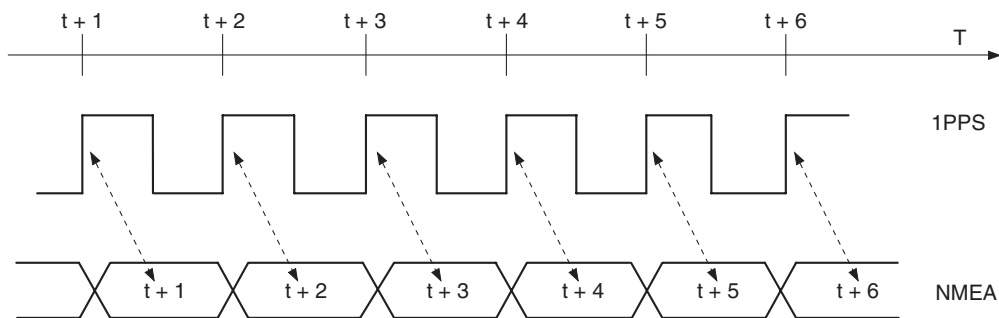



**1PPS Output**

The 1PPS output provides a timing pulse synchronized to GPS time once a valid fix is available. The figure below shows the behavior of the 1PPS output signal after reset. For a period of 160μs after reset, the 1PPS signal outputs the system clock. The actual 1PPS signal is activated at 500ms after reset.

www.DataSheet4U.com

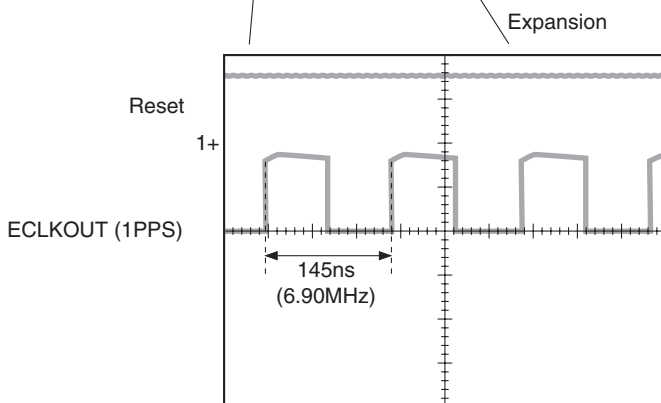
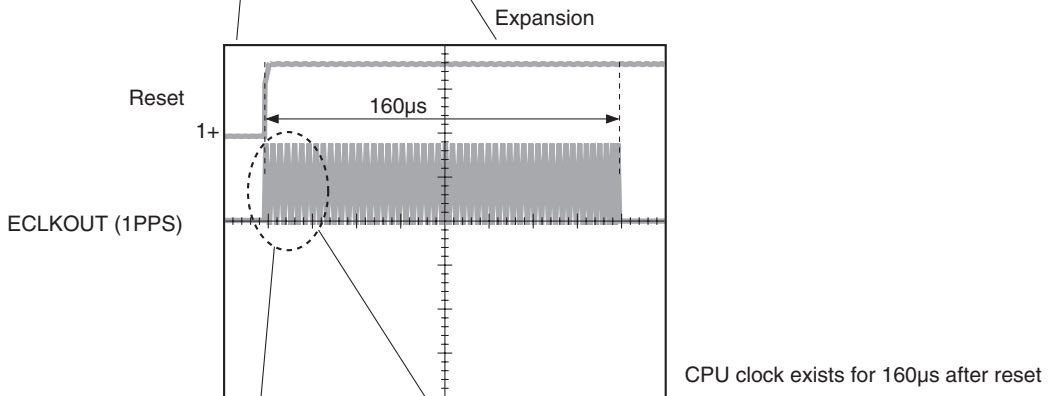
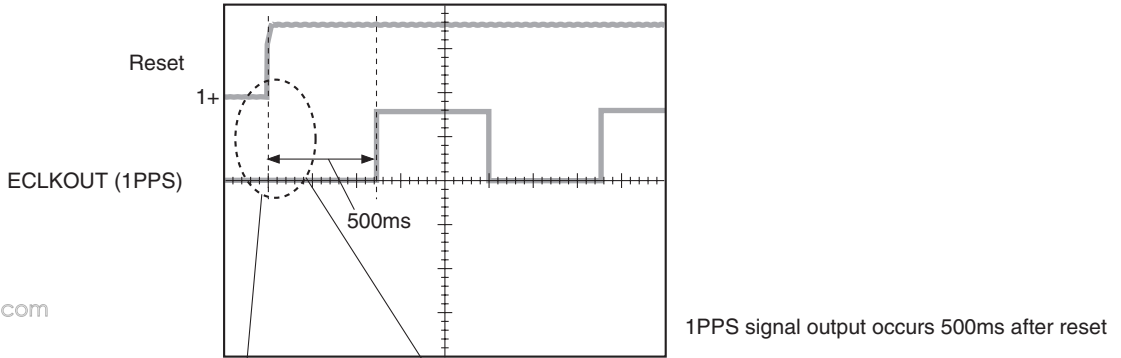

---

### **Backup Mode**

The backup mode is established by setting all inputs Low except for B.U. (Vbat: 2.6 to 3.0V). In this mode, the low power consumption can be achieved by stopping all oscillators except for RTC oscillator. Although all registers are initialized, the SRAM for both of Ephemeris data and Almanac data in backup area are held.

---

### **Command Specifications**

The GXB5205 modules have a command format, NMEA-0183 version 3.01. A list of the supported UART interface is as follows. For detailed descriptions, see the CXD2951 Communication Command Specification document.

## Label Printing

The following label containing these items is put on a module after inspections.  
(The details of printing contents are specified separately.)



www.DataSheet4U.com

- ① Product name
- ② Manufacturing history: OO = year, △△ = month, × × = day
- ③ Version of software
- ④ Manufacturer
- ⑤ Country of origin
- ⑥ Manufacturing company (MKM)
- ⑦ Code number: 8-753-243-58



Tray

(Unit: mm)

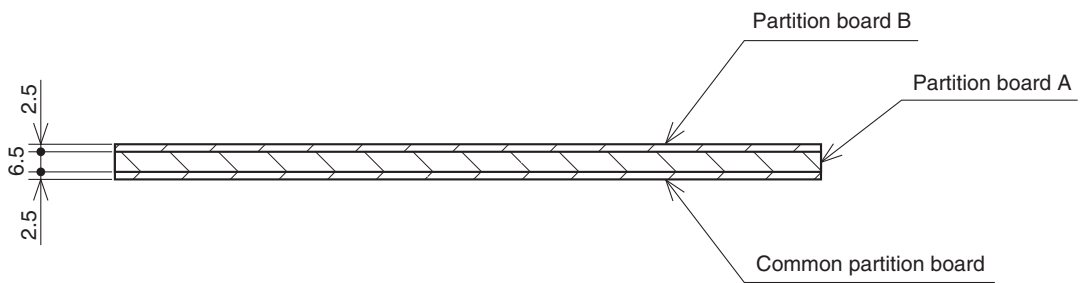
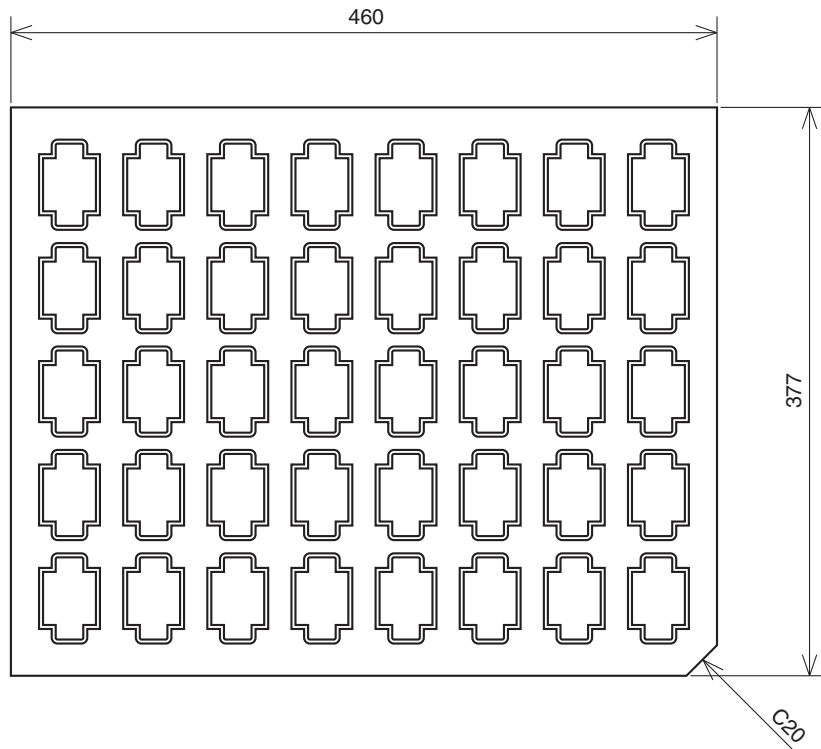

- Note) 1. Bond Partition boards A and B, and the common partition board with adhesive.  
 2. Be careful of the direction on bonding.  
 3. This part should not contain any substances which are specified in SS-00259-1.