

PHASE CONTROL THYRISTOR H30TB/TLXX

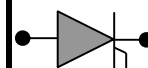

Symbol	Characteristics	Conditions	T _J (°C)	Value	Unit
BLOCKING PARAMETERS					
V _{RRM}	Repetitive peak reverse voltage		125	200-1600	V
V _{DRM}	Repetitive peak off-stage voltage		125	200-1600	V
I _{RRM}	Repetitive peak reverse current	V = V _{RRM}	125	15	mA
I _{DRM}	Repetitive peak off-state current	V = V _{RRM}	125	15	mA
dV/dT	Rep. rate of change of voltage	@ 67%V _{DRM}	125	600	V/μS
CONDUCTING PARAMETERS					
I _{F(AV)}	Average on-state current	180 sine, 50Hz, T _C = 85°C		30	A
I _{RMS}	RMS on-state current			50	A
I _{TSM}	Surge on-state current	Sine wave, 10mS without reverse voltage	125	500	A
I ² t	I ² t			1250	A ² S
V _T	Peak on-state voltage drop	On-state current = 100A	125	1.72	V
V ₀	Threshold voltage		125	0.95	V
r ₀	On-state slope resistance		125	6.40	mΩ
di/dt	Repetitive rate of rise of current	dI _G /dT = 1A/μS V _{GK} = 1V	125	100	A/μS
TRIGGERING PARAMETERS					
I _{GT}	Gate trigger current	V _D = 5V	25	100	mA
V _{GT}	Gate trigger voltage		25	2.50	V
I _L	Latching Current	V _D = 5V	25	300	mA
I _H	Holding Current	V _D = 5V	25	200	mA
P _{G -PEAK}	Maximum Peak Gate Power	Pulse width 100μSec		30	W
V _{FGM}	Maximum forward gate voltage			12	V
I _{FGM}	Maximum forward gate current			10	A
THERMAL & MECHANICAL PARAMETERS					
R _{TH(J-C)}	Thermal impedance, 180 conduction, Sine	Junction to case		0.93	°C/W
R _{TH(C-HK)}	Thermal impedance	Case to heatsink		0.30	°C/W
T _J	Maximum Permissible junction temperature			125	°C
T _{STG}	Storage temperature range			-40 - 125	°C
F	Mounting Torque			2	NM
W	Weight	For TB For TL		30 15	gms



HIND RECTIFIERS LTD

1 of 6

PHASE CONTROL THYRISTOR H30TB/TLXX

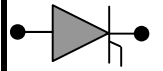

H30TLXX

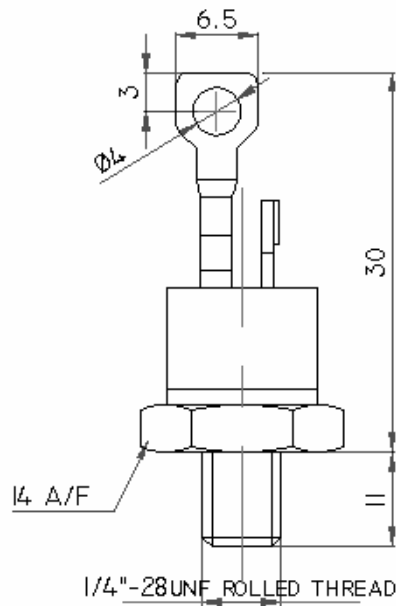

H30TBXX

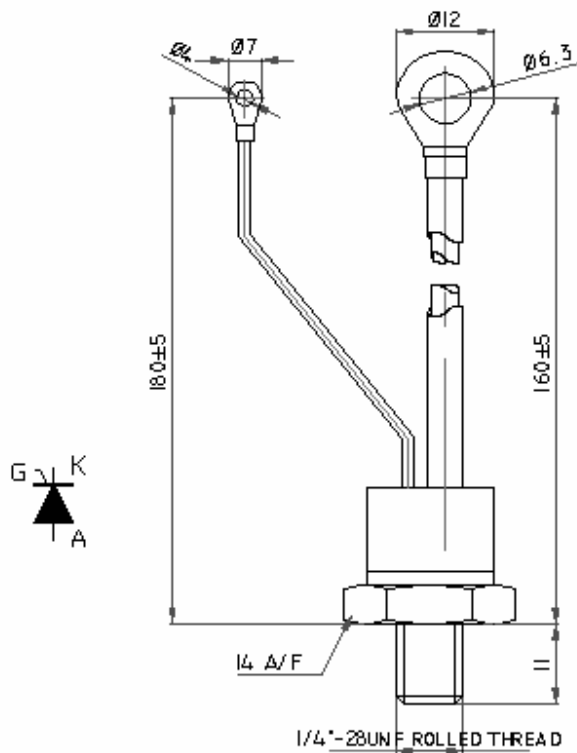

All dimensions in mm



HIND RECTIFIERS LTD

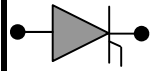

On State Power Loss

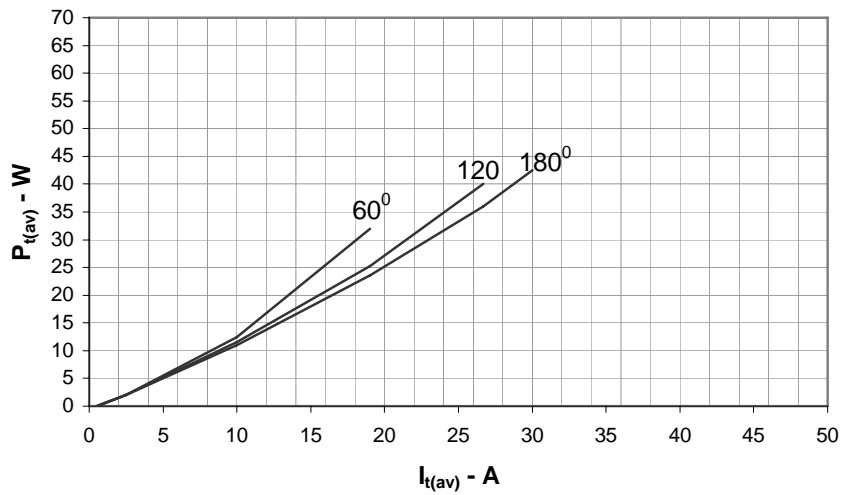

Maximum Permissible Case Temp

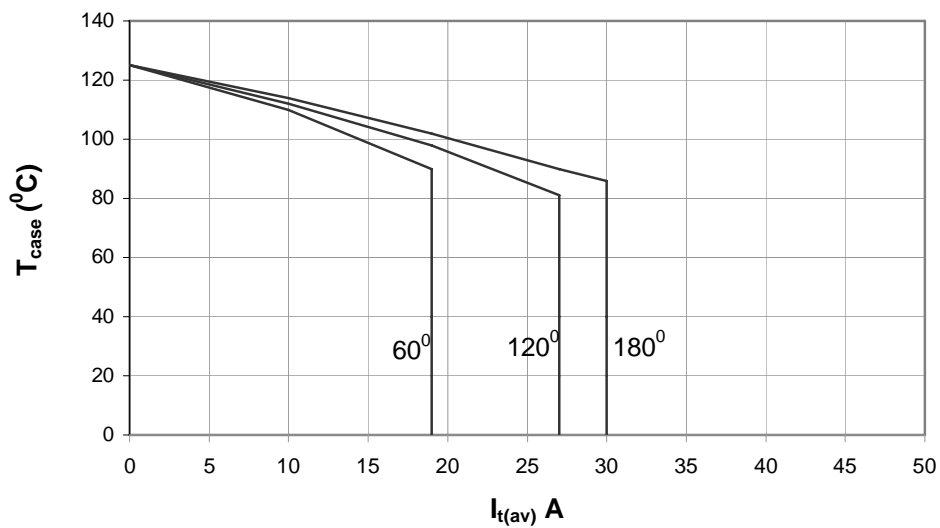

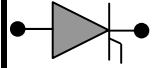

Max non repetitive Surge Current

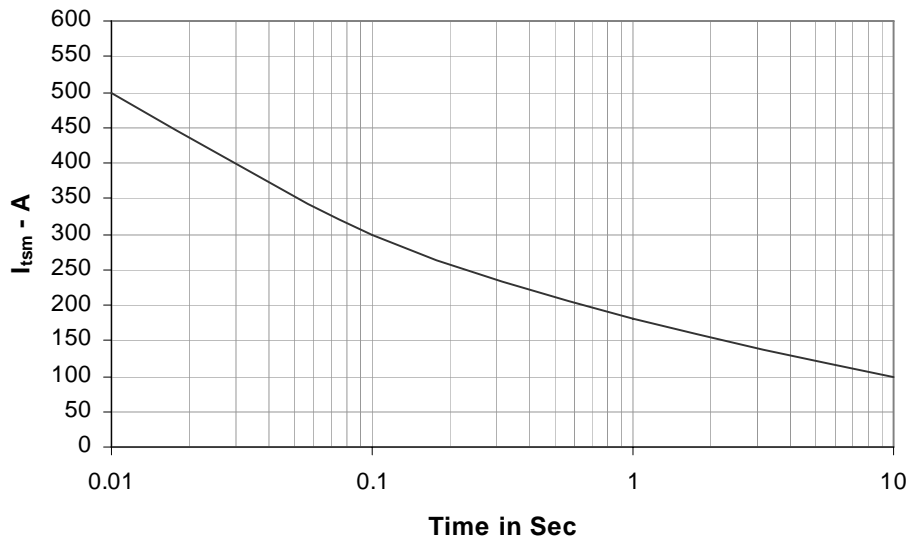

Transient Thermal Impedance Junction to Case

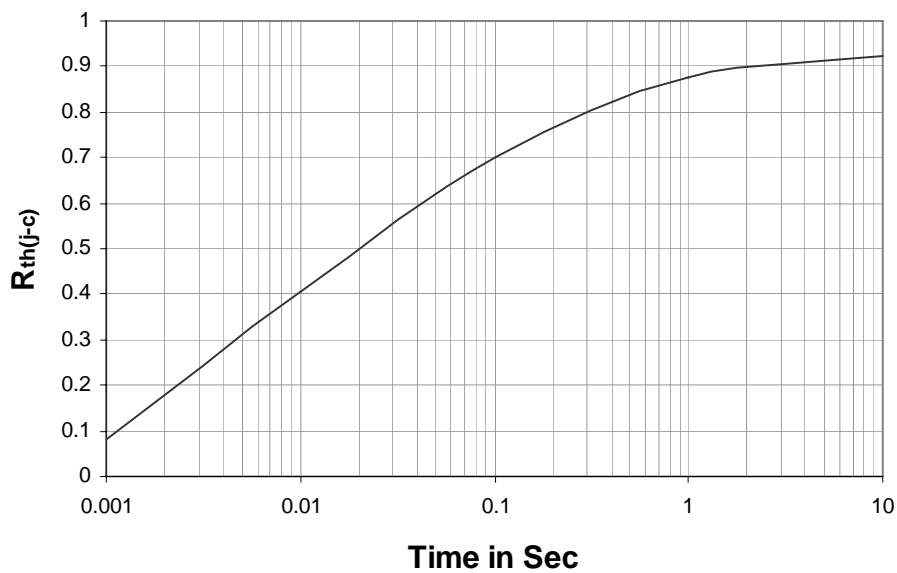

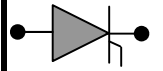

On State Characteristics

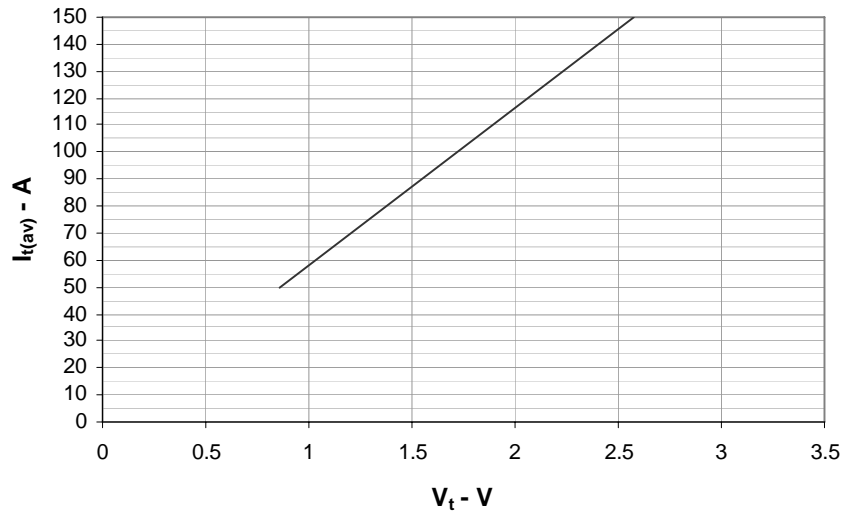

Gate Trigger Characteristics

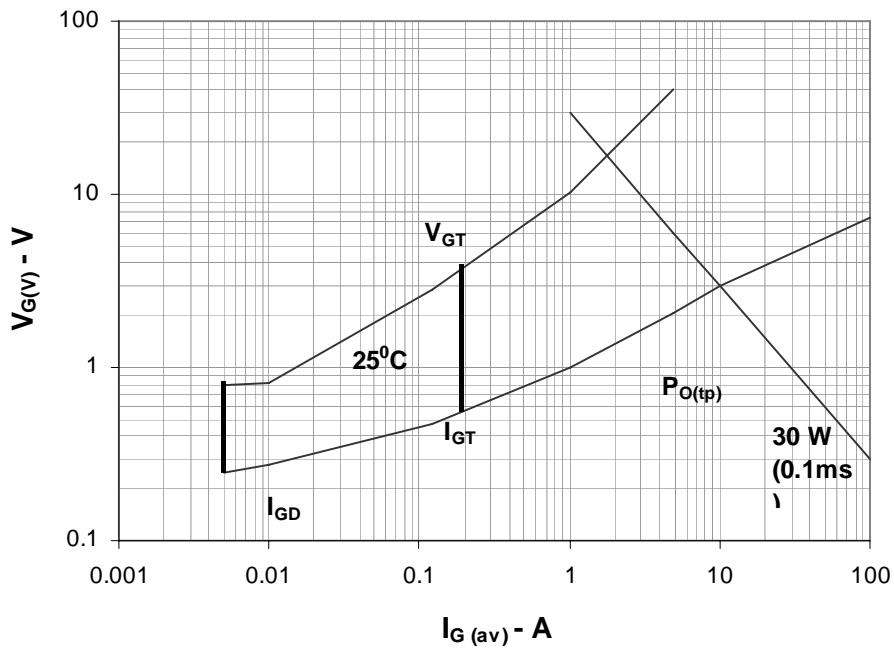

PHASE CONTROL THYRISTOR H30TB/TLXX

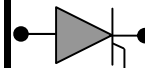

Ordering Information: -

H	30	TB / TL	XX
Hirect make Thyristor	$I_{F(AV)} = 30A$	TB - with a Pigtail TL - with Lug	$V_{RRM} = XX \times 100$ e.g. 12 * 100 = 1200V

Hind Rectifiers Ltd reserves the right to change the specifications without notice.

This datasheet specifies technical information for semiconductor devices but promises no characteristics. No warranty or guarantee expressed or implied is made regarding delivery, performance or suitability.

Hind Rectifiers Ltd

Lake Road

Bhandup (West)

Mumbai – 400 078

Tel: - +91 22 2596 8027/28/29/31

Fax: - +91 22 2596 4114

E-mail: - marketing@hirect.com

Website: - www.hirect.com

June-2008



HIND RECTIFIERS LTD

6 of 6