

1/16 DIN Analog-Set Timer with Many Time Ranges, Operating Modes and Wide Supply Voltage Range

- Field-selectable time ranges from 0.05 second to 300 hours or 0.1 second to 600 hours
- Select 2-, 4-, or 6-function models to handle most applications
- Wide range AC/DC supply voltage models (AC100-240/DC100-125 or AC24-48/DC12-24)
- PNP input now available
- Short, 80 mm (3.15 inch) panel mounting depth with socket allows space-efficient control panel design
- Choice of light gray, medium gray, or black panel covers to match panel aesthetics
- UL, CSA, CE approved



Ordering Information

■ TIMERS

Timing function	ON-Delay, Repeat cycle (B, B2), Signal ON/OFF delay, Signal OFF-delay, Interval	Signal ON/OFF-delay, One-shot	Signal ON/OFF-delay, One-shot	ON-Delay, Repeat cycle ON, Interval, One-shot	ON-Delay, Repeat cycle ON, Interval, One-shot
Time range	0.05 s to 300 hr	0.05 s to 300 hr	0.1 s to 600 hr	0.05 s to 300 hr	0.1 s to 600 hr
Terminal form	11-pin round	11-pin round	11-pin round	8-pin round	8-pin round
Part number/ contact output	H3CR-A AC100-240/DC100-125	H3CR-A-300 AC100-240/DC100-125	H3CR-A-301 AC100-240/DC100-125	H3CR-A8 AC100-240/DC100-125	H3CR-A8-301 AC100-240/DC100-125
	H3CR-A AC24-48/DC12-48	H3CR-A-300 AC24-48/DC12-48	H3CR-A-301 AC24-48/DC12-48	H3CR-A8 AC24-48/DC12-48	H3CR-A8-301 AC24-48/DC12-48
	H3CR-AP AC100-240/DC100-125	—	—	—	—
	H3CR-AP AC24-48/DC12-48	—	—	—	—
Part number/ transistor output	H3CR-AS AC24-48/DC12-48	—	—	H3CR-A8S AC24-48/DC12-48	—
Part number/ time-limiting and instantaneous contact output	—	—	—	H3CR-A8E AC100-240/DC100-125	—
	—	—	—	H3CR-A8E AC24-48/DC12-48	—

MODEL NUMBER LEGEND

H3CR-A -

1 2 3 4

1. Terminal Form (Number of Pins)

None: 11-pin models

8: 8-pin models

2. Input Type for 11-pin Models

None: No-voltage input (NPN type)

P: Voltage input (PNP type)

3. Output

None: Relay output (DPDT)

S: Transistor output (NPN/PNP universal use)

E: Relay output (SPDT) with instantaneous relay output (SPDT)

4. Suffix

300: Dual mode models (signal ON/OFF-delay and one-shot)

301: Double time scale (range) models (0.1 s to 600 h)

www.DataSheet4U.com

ACCESSORIES

Description		Part number	
Sockets	11-pin	Bottom surface or track mounting, top screw terminals	P2CF-11
		Bottom surface or track mounting, top screw terminals, finger safe terminal conforms to VDE0106/P100	P2CF-11-E
		Back mounting, for use with Y92F-30 mounting adapter, bottom screw terminals	P3GA-11
	8-pin	Bottom surface or track mounting, top screw terminals	P2CF-08
		Bottom surface or track mounting, top screw terminals, finger safe terminal conforms to VDE0106/P100	P2CF-08-E
		Back mounting, for use with Y92F-30 mounting adapter, bottom screw terminals	P3G-08
		Terminal cover for P3G sockets, conforms to VDE0106/P100	Y92A-48G
Panel mounting adapter	Fits behind panel, ideal for side-by-side installation. Use P3G _ _ sockets		Y92F-30
	Panel-mounting adapter (88 mm x 58 mm x 66 mm)		Y92F-73
	Panel-mounting adapter (58 mm x 50 mm x 66 mm)		Y92F-74
Protective cover	Hard plastic cover protects against dust, dirt and water; not for use with panel covers		Y92A-48B
NEMA 4 cover	Waterproof front cover		Y92A-48N
Colored panel covers	Light gray (Munsell No. 5Y7/1) to match case		Y92P-48GL
	Medium gray (Munsell No. 5Y5/1)		Y92P-48GM
	Black (Munsell No. N1.5)		Y92P-48GB
Time setting rings	Used to lock-in a single setting; one ring, can be used with Y92P panel covers		Y92S-27
	Used to lock-in a setting range; two rings, can be used with Y92P panel covers		Y92S-28
Mounting track	DIN rail, 50 cm (1.64 ft) length; 7.3 mm thick		PFP-50N
	DIN rail, 1 m (3.28 ft) length; 7.3 mm thick		PFP-100N
	DIN rail, 1 m (3.28 ft) length; 16 mm thick		PFP-100N2
End plate			PFP-M
Spacer			PFP-S

■ RANGE AND OPERATION MODE SELECTION

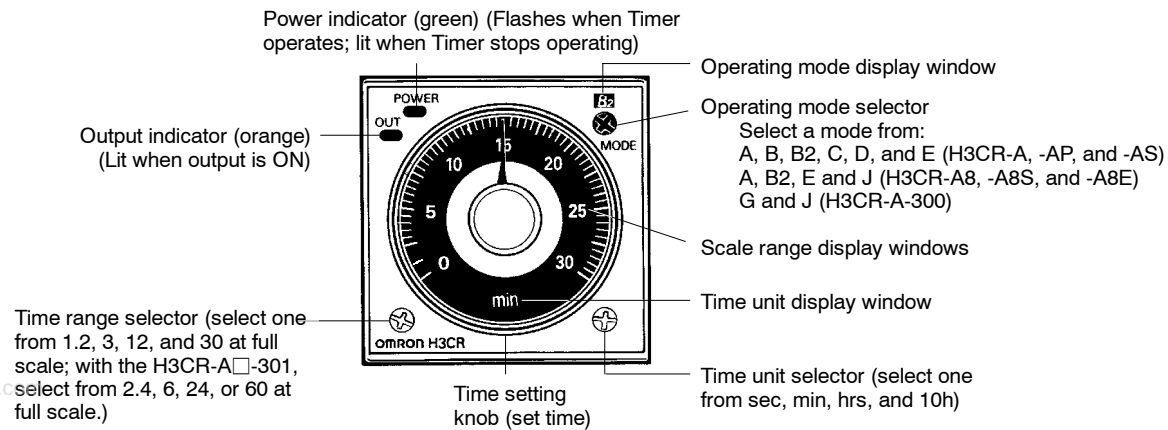

Operating Modes

Model	H3CR-A/-AS	H3CR-AP	H3CR-A8/-A8S	H3CR-A8E
Operating mode	A: ON-delay B: Repeat-cycle OFF start B2: Repeat-cycle ON start C: Signal ON/OFF-delay D: Signal OFF-delay E: Interval G: Signal ON/OFF-delay (Only for H3CR-A-300) J: One-shot (Only for H3CR-A-300)		A: ON-delay (power supply start) B2: Repeat-cycle ON start (power supply start) E: Interval (power supply start) J: One-shot (power supply start)	

Time Ranges

Note: When the time setting knob is turned below "0" until the point where the time setting knob stops, the output will operate instantaneously at all time range settings.

Standard (0.05-s to 300-h) Models

Time unit		s (sec)	min	h (hrs)	x10 h (10 h)
Full scale setting	1.2	0.05 to 1.2	0.12 to 1.2		1.2 to 12
	3	0.3 to 3			3 to 30
	12	1.2 to 12			12 to 120
	30	3 to 30			30 to 300

Double (0.1-s to 600-h) Models

Time unit		s (sec)	min	h (hrs)	x10 h (10 h)
Full scale setting	2.4	0.1 to 2.4	0.24 to 2.4		2.4 to 24
	6	0.6 to 6			6 to 60
	24	2.4 to 24			24 to 240
	60	6 to 60			60 to 600

Specifications

■ RATINGS/CHARACTERISTICS

Item	H3CR-A/A8	H3CR-AP	H3CR-A8E	H3CR-AS/A8S	
Rated supply voltage (See Note 1.)	100-240 VAC (50/60 Hz)/100-125 VDC; 24-48 VAC (50/60 Hz)/12-48 VDC		100-240 VAC (50/60 Hz)/100-125 VDC; 24-48 VAC (50/60 Hz)/12-48 VDC (See Note 2.)	24-48 VAC (50/60 Hz)/ 12-48 VDC	
Operating voltage	85% to 110% of rated supply voltage (90% to 110% at 12 VDC)				
Power reset	Minimum power-opening time: 0.1 s				
Power consumption	100 to 240 VAC/100 to 125 VAC	At 240 VAC, 60 Hz Relay ON: approx. 2.1 VA (1.6 W) Relay OFF: approx. 1.3 VA (1.1 W)	At 240 VAC, 60 Hz Relay ON: approx. 2.5 VA (2.2 W) Relay OFF: approx. 1.8 VA (1.7 W) (See Note 3.)	At 240 VAC, 60 Hz Relay ON/OFF: approx. 2 VA (1 W)	N/A
	24-48 VAC/12-48VDC	At 24 VDC Relay ON: approx. 0.8 W Relay OFF: approx. 0.2 W	At 24 VDC Relay ON: approx. 0.9 W Relay OFF: approx. 0.3 W	At 24 VDC Relay ON/OFF: approx. 0.9 W	At 24 VDC Output ON: 0.3 W Output OFF: approx. 0.2 W
Inputs Start, reset and gate	<u>No-voltage Input, NPN type (H3CR-A only)</u> ON impedance: 1 k Ω ON residual voltage: 1 V max. Off impedance: 100 k Ω min.	<u>Voltage Input, PNP type</u> Max. capacity allowed between input lines (terminal 6 and 7 or 6 and 8) is 1200 μ F Load connectable in parallel with inputs (terminals 6 and 7 or 6 and 8). • 100 to 240 VAC/100 to 125 VDC High (logic) level: 85 to 264 VAC/ 85 to 137.5 VDC Low (logic) level: 0 to 10 VAC/ 0 to 10 VDC • 24 to 48 VAC/ 12 to 48 VDC High (logic) level: 20.4- 52.8 VAC/ 10.8- 52.8 VDC Low (logic) level: 0 to 2.4 VAC/ 0 to 1.2VDC	—	<u>No-voltage Input, NPN type (H3CR-AS only)</u> ON impedance: 1 k Ω ON residual voltage: 1 V max. OFF impedance: 100 k Ω min.	
Control outputs	Time limit	Relay output (DPDT)	Relay output (DPDT)	Relay output (SPDT)	Transistor output (See Note 5.)
	Instantaneous	—	—	Relay output (SPDT)	—
	Max. load	5 A at 240 VAC/30 VDC, resistive load ($\cos \phi = 1$) max. load		5 A at 250 VAC resistive load ($\cos \phi = 1$)	100 mA max. at 30 VDC max.
	Min. load	10 mA at 5 VDC			
	Residual voltage	—	—	—	2 V max.
Repeat accuracy	$\pm 0.2\%$ FS max. ($\pm 0.2\% \pm 10$ ms max. in a range of 1.2 s)				
Setting error	$\pm 5\%$ FS ± 50 ms (See Note 4.)				

- Note: 1. DC ripple rate: 20% max. if the power supply incorporates a single-phase, full-wave rectifier.
 2. The 24 to 48 VAC/12 to 48 VDC model causes an inrush current of approximately 0.85 A. Take precaution when applying power to these models, especially if there is a non-contact output like a sensor.
 3. The values are for when the terminals 2 and 7 and terminals 10 and 6 are shorted, and include the consumption current of the input circuit.
 4. The value is $\pm 5\%$ FS +100 ms to 0 ms max. when the C, D, or G mode signal of the H3CR-AP is OFF.
 5. The internal circuits are optically isolated from the output. This enables universal application as NPN or PNP transistor.

Item	H3CR-A/A8	H3CR-AP	H3CR-A8E	H3CR-AS/A8S
Reset time	Min. power-opening time: 0.1 s max. Min. pulse width: 0.05 s (H3CR-A/-AS)			
Reset voltage	10% max. of rated voltage			
Resetting system	Power OFF, external, self resetting (11-pin models); Power OFF (8-pin models)			
Indicators	Power ON indicator (green LED), Output ON indicator (orange LED)			
Material	Plastic case (light gray Munsell 5Y7/1) and knob (clear)			
Mounting method	DIN track mounting, surface mounting, and flush mounting			
Connection	11-pin (H3CR-A) 8-pin (H3CR-A8)	11-pin	8-pin	11-pin (H3CR-AS) 8-pin (H3CR-A8S)
Weight	Approx. 90 g (3.17 oz)			
Approved standards	UL508, CSA C22.2 No.14, NK, Lloyds Conforms to EN61812-1 (VDE0435/P2021), IEC60664-1 (VDE0110) 4kV/2, EN60947-5-1 (contact output), and EN60947-5-2 (non-contact output).			
Ambient temperature	Operating	-10°C to 55°C (14°F to 131°F) with no icing		
	Storage	-25°C to 65°C (-13°F to 149°F) with no icing		
Ambient humidity	Operating	35% to 85%		
Variation due to voltage change	±0.2% FS max. (±0.2% ±10 ms max. in a range of 1.2 s)			
Variation due to temperature change	±1% FS max. (±1% ±10 ms max. in a range of 1.2 s)			
Insulation resistance	100 MΩ min. (at 500 VDC)			
Vibration resistance	Destruction: 10 to 55 Hz with 0.75-mm double amplitude each in 3 directions for 2 hours each Malfunction: 10 to 55 Hz with 0.5-mm double amplitude each in 3 directions for 10 minutes each			
Shock resistance	Destruction: 1,000 m/s ² (approx. 100G) 3 times each in 6 directions Malfunction: 100 m/s ² (approx. 10G) 3 times each in 6 directions			
Static immunity	Malfunction: 8 kV Destruction: 15 kV			
Dielectric strength	2,000 VAC (1,000 VAC for H3CR-A□S), 50/60 Hz for 1 min between current-carrying metal parts and exposed non-current-carrying metal parts 2,000 VAC (1,000 VAC for H3CR-A□S), 50/60 Hz for 1 min between control output terminals and operating circuit 2,000 VAC, 50/60 Hz for 1 min between contacts of different polarities 1,000 VAC, 50/60 Hz for 1 min between contacts not located next to each other 2,000 VAC, 50/60 Hz for 1 min between input and control output terminals and operation circuit			
Impulse withstand voltage	3 kV (between power terminals) for 100 to 240 VAC/100 to 125 VDC; 1 kV for 24 to 48 VAC/12 to 48 VDC 4.5 kV (between current-carrying terminal and exposed non-current-carrying metal parts) for 100 to 240 VAC/100 to 125 VDC; 1.5 kV for 24 to 48 VAC/12 to 48 VDC and 24 to 48 VAC/VDC			
EMC	(EMI) EN50081-2 Emission enclosure: EN55011 Group 1 class A Emission AC mains: EN55011 Group 1 class A (EMS) EN50082-2 Immunity ESD: EN61000-4-2: 4 kV contact discharge (level 2) 8 kV air discharge (level 3) Immunity RF-interference from AM radio waves: ENV50140: 10 V/m (80 MHz to 1 GHz) (level 3) Immunity RF-interference from pulse-modulated radio waves: ENV50204: 10 V/m (900±5 MHz) (level 3) Immunity conducted disturbance: ENV50141: 10 V (0.15 to 80 MHz) (level 3) Immunity burst: EN61000-4-4: 2 kV power-line (level 3) 2 kV I/O signal-line (level 4) Immunity surge: EN61000-4-5: 1 kV line to line 2 kV line to ground (level 3)			
Degree of protection	IP40 (front face)			
Life expectancy	Mechanical	20,000,000 operations min. (under no load at 1,800 operations/h)		
	Electrical	100,000 operations min. (5 A at 250 VAC, resistive load at 1,800 operations/h)		

Engineering Data

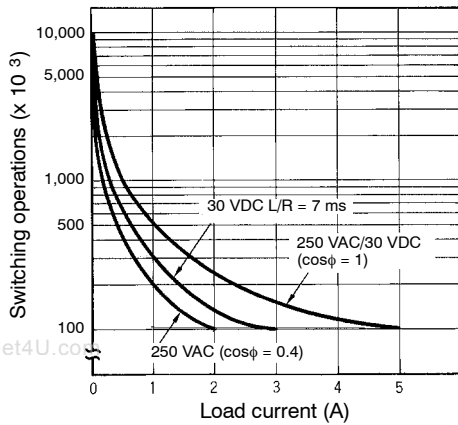

Note: A maximum current of 0.15 A can be switched at 125 VDC (cosφ = 1) and a maximum current of 0.1 A can be switched if L/R is 7 ms. In either case, a service life of 100,000 operations can be expected. The minimum applicable load is 10 mA (100 mA for H3CR-A8E) at 5 VDC (failure level: P).

Timing Charts

- Note: 1. The minimum power-opening time ("Rt") is 0.1 s and the minimum pulse width is 0.05 s.
- 2. The letter "t" in the timing charts stands for the set time and "t-a" means that the period is less than the time set.

H3CR-A/-AS/-AP

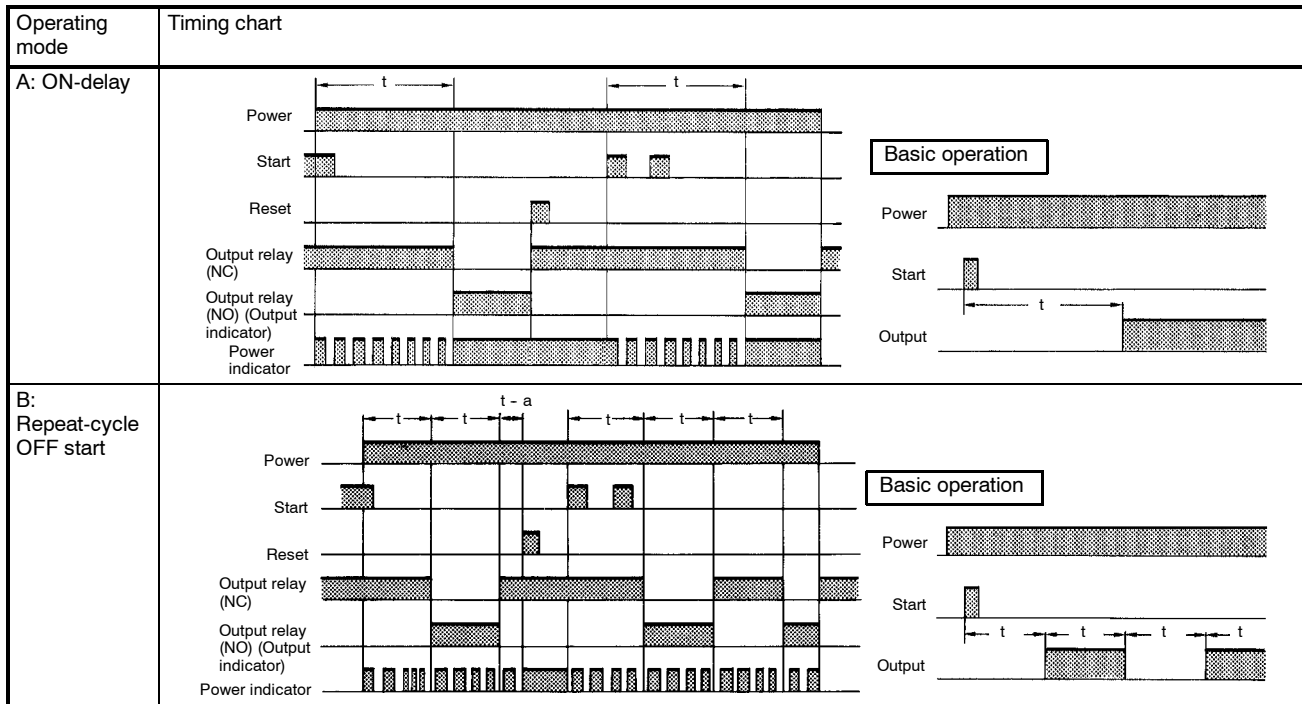

Operating mode	Timing chart
<p>B2: Repeat-cycle ON start</p>	
<p>C: Signal ON/OFF-delay</p>	
<p>D: Signal OFF-delay</p>	
<p>E: Interval</p>	
<p>G: Signal ON/OFF-delay</p>	

H3CR-A/-AS/-AP (continued)

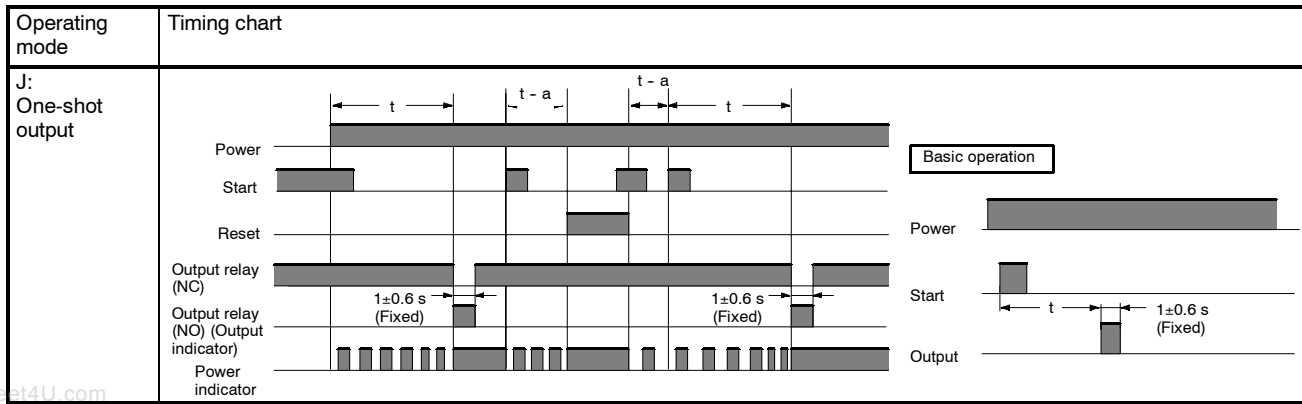

H3CR-A8/-A8S

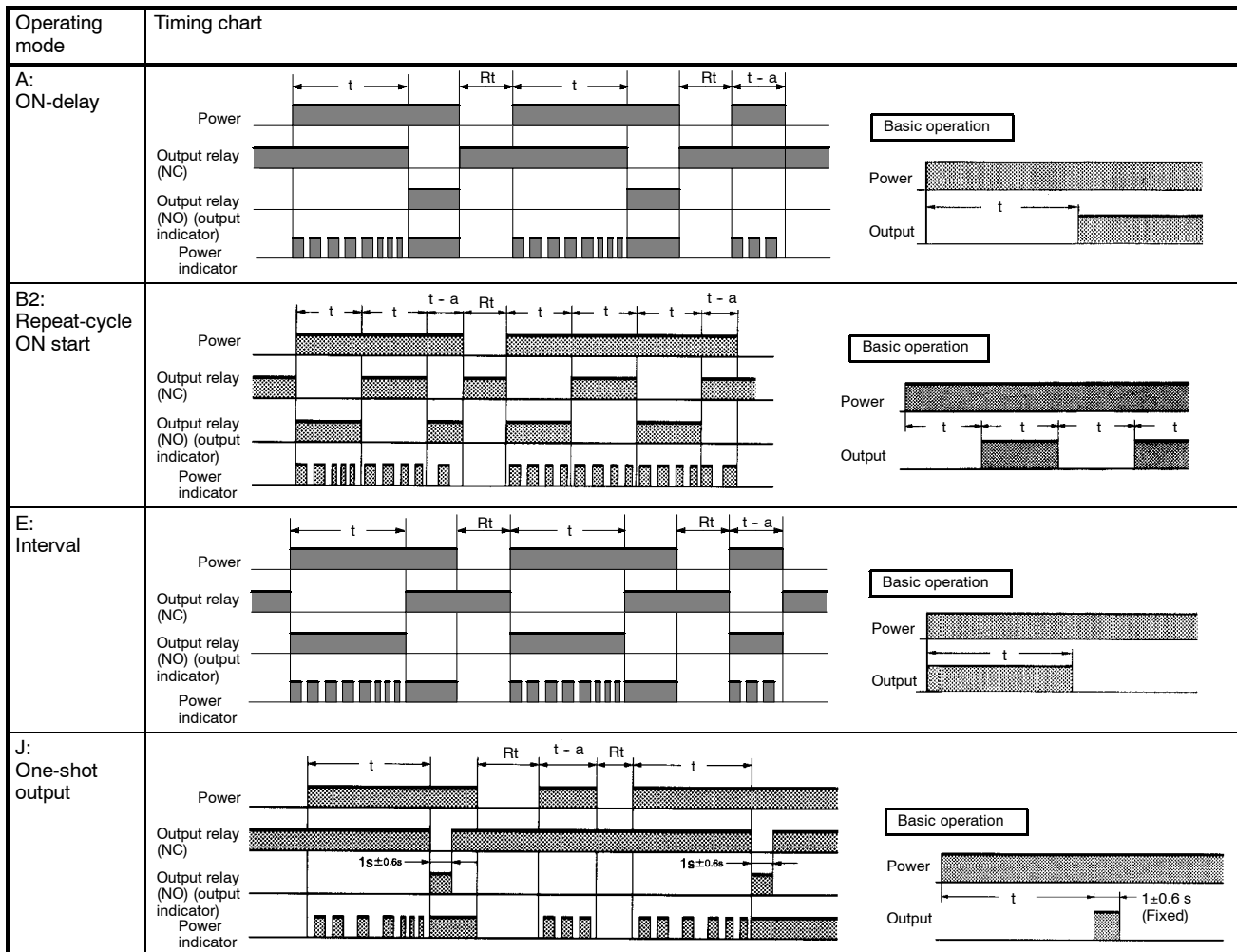

H3CR-A8E

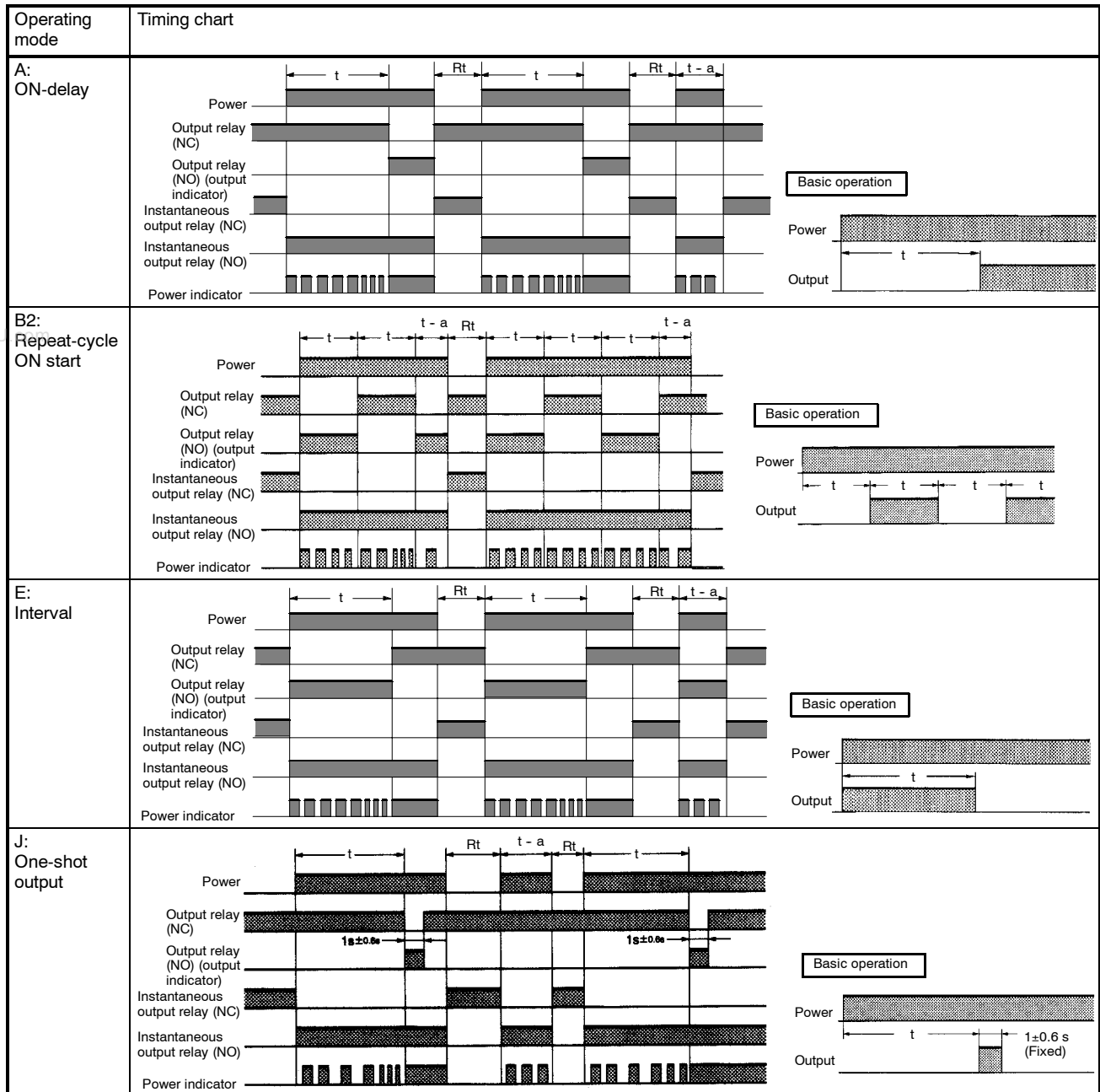

APPLICATION EXAMPLES

A Mode: ON-delay

ON-delay operation (A mode) is a basic mode.

1. Power-ON Start/Power-OFF Reset

The power-ON start/Power-OFF reset operation is a standard operating method. The start terminals are connected. Timing starts when power is applied. The output is energized when the accumulated time equals the set time. The output relay or transistor remains energized until power is disconnected or a reset input is applied. The minimum resetting time is 0.1 second.

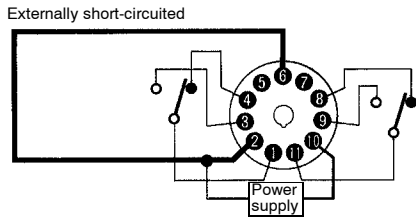
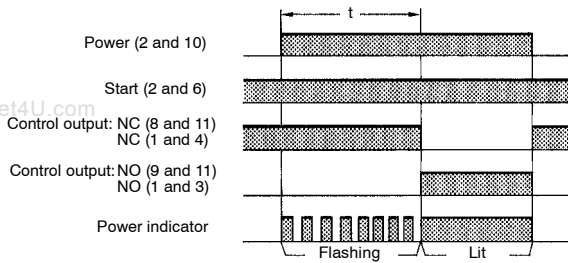

2. Signal Start/Signal Reset

The signal start/Signal reset operation is useful for remote control of the Timer. Power is applied continuously. Timing starts at the leading edge of the start input. The output relay is energized when the accumulated time equals the set time. Subsequent start signals that occur during or after timing will not be accepted. The output relay or transistor will remain energized until a reset input is applied or power is interrupted. The minimum signal input is 0.05 second.

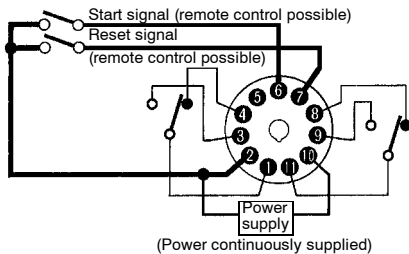
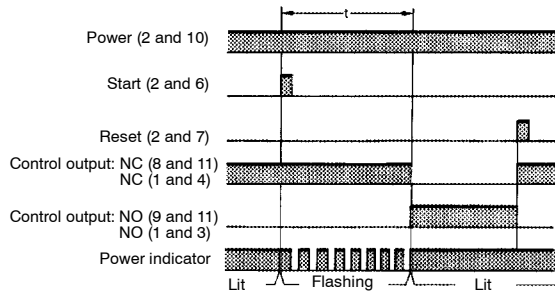

3. Cumulative Timing Using the Gate Input with ON-Delay

With a gate signal, the Power-ON start operation and Signal start operation can be controlled (the operation can be interrupted). When the gate signal is closed, timing is temporarily stopped. When the gate signal opens, timing resumes at the point of interruption. The gate input terminal permits the timer to sum up times t_1 and t_2 as shown in the timing chart.

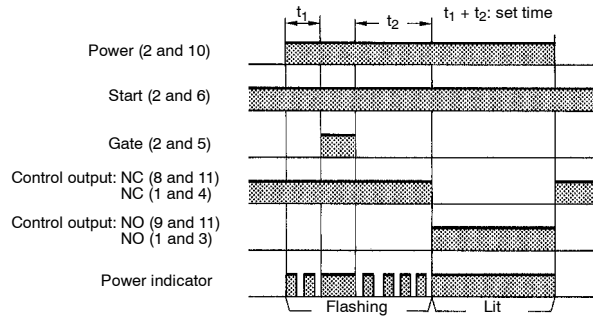

Gate signal (The operation is interrupted with the gate signal if the Timer detects an abnormal signal.)

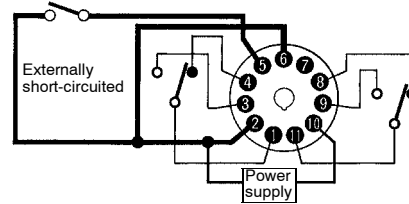

B/B2 Mode: Repeat Cycle

The repeat cycle operation in the B and B2 modes can be effectively applied to lamp or buzzer (ON and OFF) alarms or the monitoring of an intermittent operation with a display.

1. Power-ON Start/Power-OFF Reset

The start terminals are connected. Timing starts when power is applied. The output relay or transistor operates according to mode B (OFF/ON/OFF pattern) or mode B2 (ON/OFF/ON pattern), whichever is set. The cycle repeats until a reset input is applied or power is disconnected.

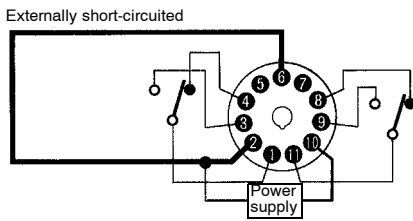
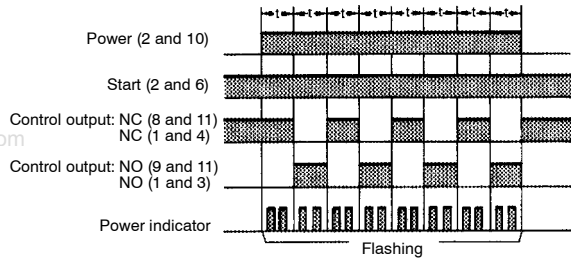

2. Signal Start/Signal Reset

If there is an abnormal signal, flashing starts. When the abnormal condition is restored, a reset signal stops the display flashing. Power is continuously applied. The ON/OFF cycle is initiated at the leading edge of the start input.

In Mode B the output relay or transistor will be OFF for the set time and then ON for the set time, creating an operation pattern of OFF/ON/OFF.

In Mode B2 the output relay or transistor will turn ON for the set time and then OFF for the set time, creating an operation pattern of ON/OFF/ON. This cycle will be repeated until a reset input is applied or power is disconnected. The minimum signal input time is 0.05 second.

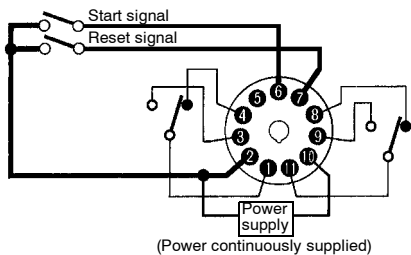
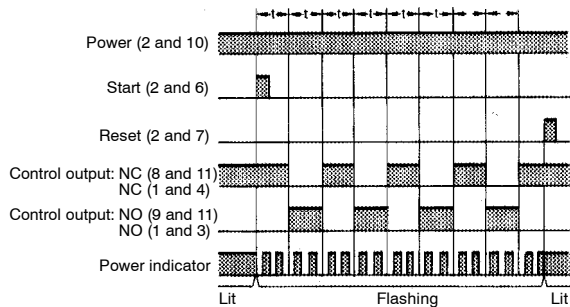

C Mode: Signal ON/OFF-delay

The Signal ON/OFF-delay operation (C mode) is useful for the control of distribution of products on a production line into boxes by the specified number or time.

1. Power-ON Start/Instantaneous Operation/Time-limit Reset

The timing cycle starts when power is applied. When the timer reaches set point, the output status changes and holds that status until power turns OFF to reset the timer. Minimum reset time is 0.1 second.

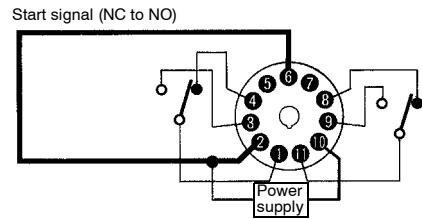
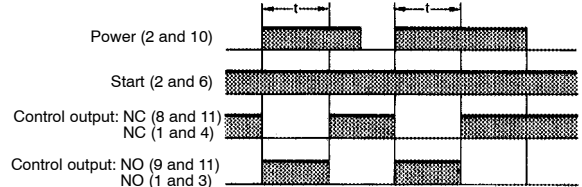

2. Signal-ON-OFF Start/Instantaneous Operation/Time-limit Reset

Power is continuously applied. The first timing cycle begins when the input signal is applied, the second when it is removed. The output relay or transistor is energized when the lapsed time from the first timing cycle equals the set point. The output remains energized until the lapsed time of the second timing cycle equals the set point. The minimum signal input time is 0.05 second.

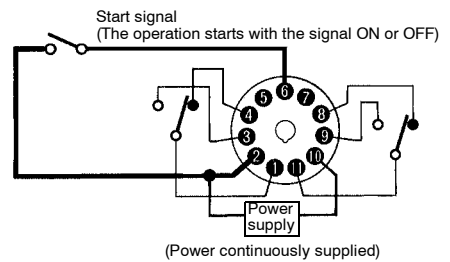
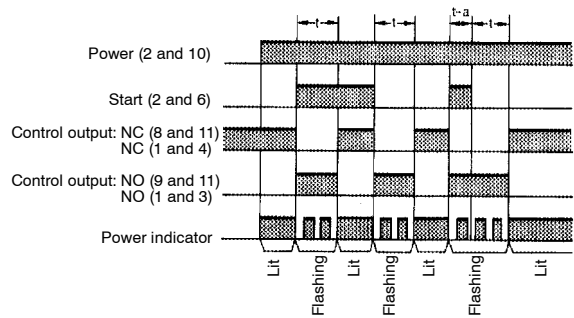

3. Signal Start/Instantaneous Operation/Time-limit Reset

Power is continuously applied. The output relay is energized at the leading edge of the start input. Timing starts at the trailing edge of the start input. The output relay is de-energized when the accumulated time equals the set time. The minimum signal input time is 0.05 second.

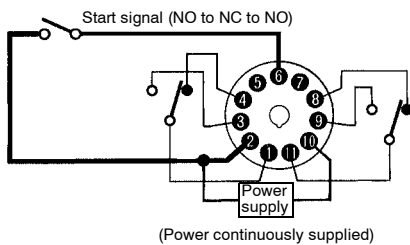
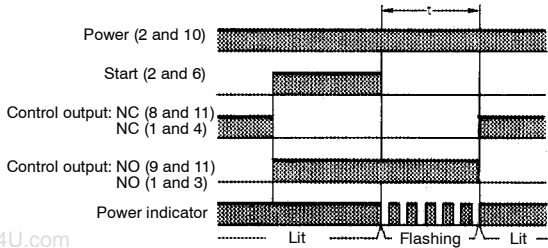

E Mode: Interval

1. Signal Start/Instantaneous Operation/Time-limit Reset

This function is useful for the repetitive control such as the filling of liquid for a specified period after each Signal start input. Timing begins on the leading edge of the start signal. The control output is only energized during timing. The timer is reset when a reset signal is applied.

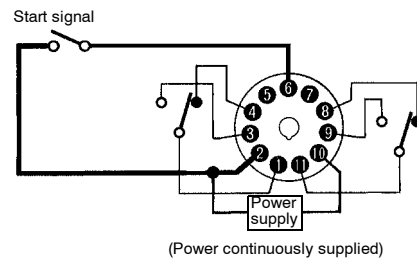
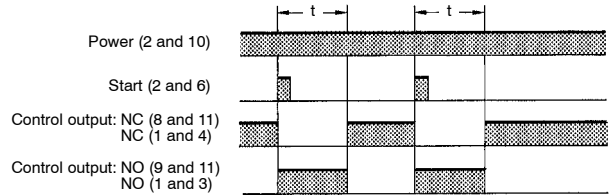

D Mode: Signal OFF-delay

Signal OFF-delay operation (D mode) can be effectively used to keep a load operating for a certain period. For example, this function enables the cooling fan for a lamp or heater to operate for a certain period after the lamp or heater is switched OFF.

Power-ON Start/Instantaneous Operation/Time-limit Reset

Power is continuously applied. The output relay is energized at the leading edge of the start input. Timing starts at the trailing edge of the start input. The output is de-energized when the accumulated time equals the set time. The minimum reset time is 0.1 second.

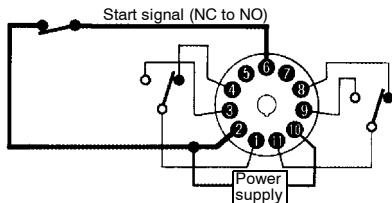
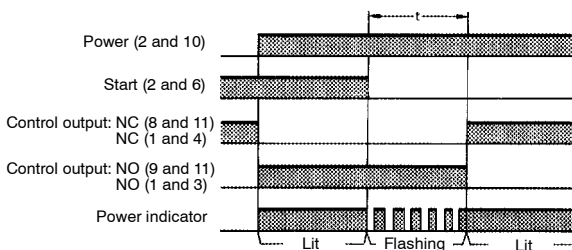

2. Power-ON Start/Instantaneous Operation/Time-limit Reset

Timing begins on the leading edge of the start signal. The control output is only energized during timing. The timer is reset when a reset signal is interrupted.

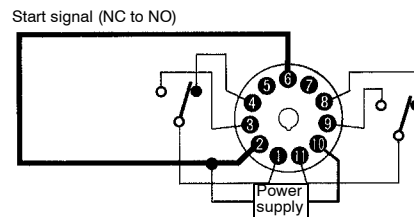
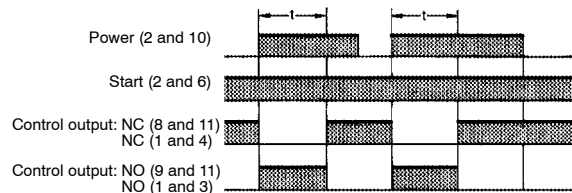

Dimensions

Unit: mm (inch)

TIMERS

11-Pin
H3CR-A
H3CR-AP
H3CR-AS

8-Pin
H3CR-A8
H3CR-A8S
H3CR-A8E

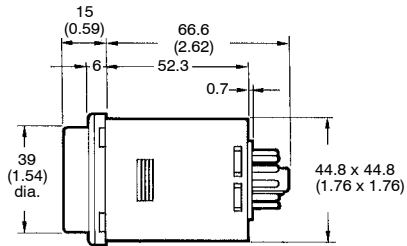
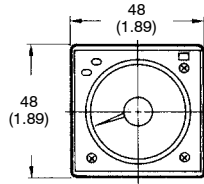
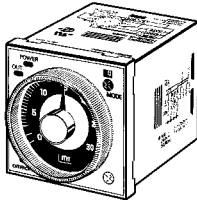

Dimensions with Y92S Set Ring and Y92P Panel Cover

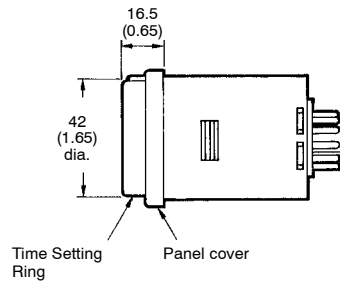
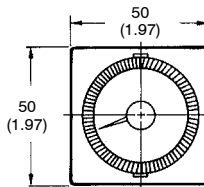
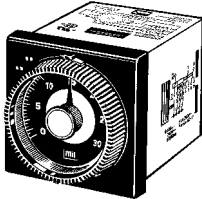

PANEL-MOUNTING ADAPTERS

Dimensions with Panel-Mounting Adapter Y92F-30

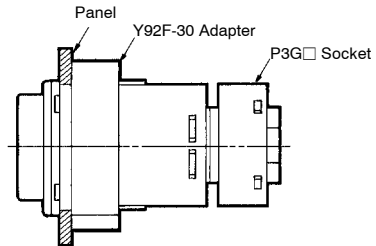
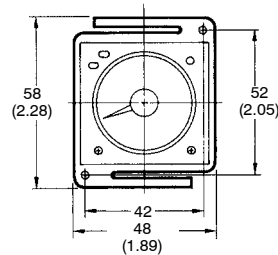
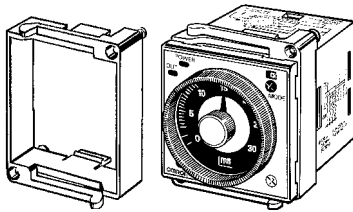

Panel Cutout

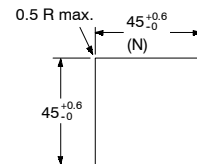

- Note: 1. The Adapters for two or more timers mounted in a vertical line are different in orientation from those mounted in a horizontal line.
- N can be obtained as follows (n: the number of H3CR models arranged side by side)
- Without a Cover: $N = (48n - 2.5) +1/-0$
 - With the Protective Cover: $N = (51n - 5.5) +1/-0$
 - With the Panel Cover: $N = (50n - 4.5) +1/-0$
2. The mounting panel thickness should be 1 to 5 mm.

**Dimensions with Panel-Mounting Adapter
Y92F-73**

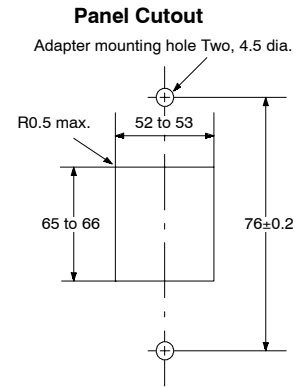
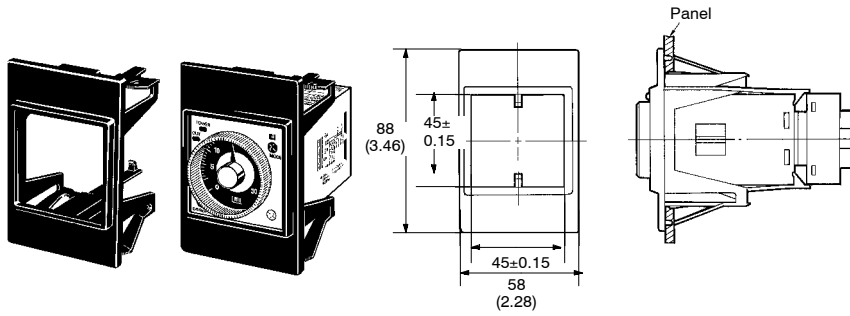

Note: The mounting panel thickness should be 1 to 3.2 mm.

**Dimensions with Panel-Mounting Adapter
Y92F-74**

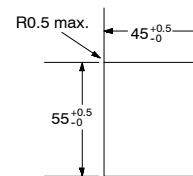
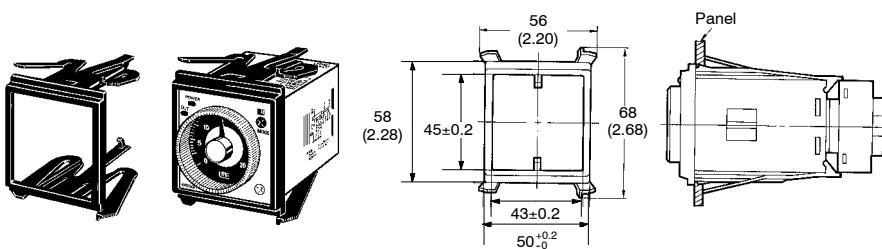

Note: The mounting panel thickness should be 1 to 3.2 mm.

TRACK MOUNTING

**Dimensions with Front-Connecting Socket
P2CF-08/P2CF-11
P2CF-08-E/P2CF-11-E**

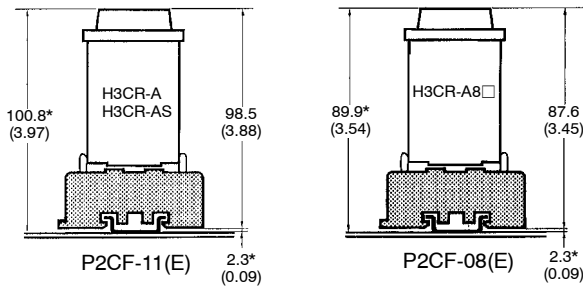

*These dimensions vary with the kind of DIN track (reference value).

PANEL MOUNTING

**Dimensions with Back-Connecting Socket
P3G-08/P3GA-11**

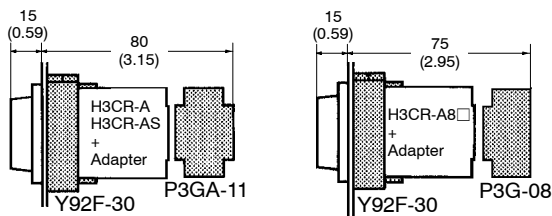

■ ACCESSORIES (ORDER SEPARATELY)

Track Mounting/
Front-Connecting Socket

P2CF-08

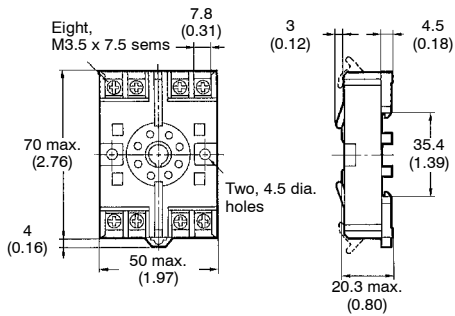
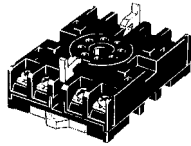

Terminal Arrangement/
Internal Connections
(Top View)

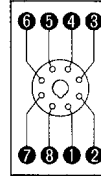

Surface Mounting Holes

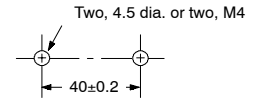

www.DataSheet4U.com

P2CF-08-E Socket
(Finger-Safe Terminal Type)

Conforming to VDE0106/P100

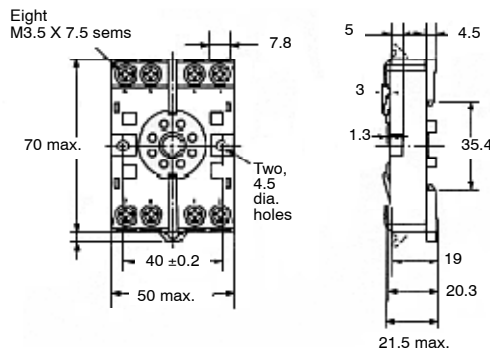
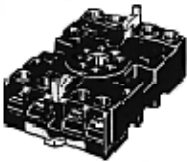

P2CF-11 Socket

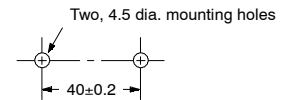
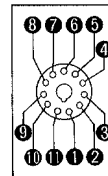
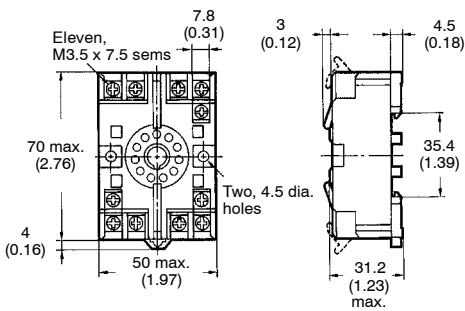
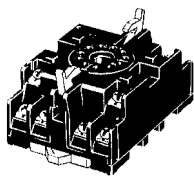

P2CF-11-E Socket
(Finger-Safe Terminal Type)

Conforming to VDE0106/P100

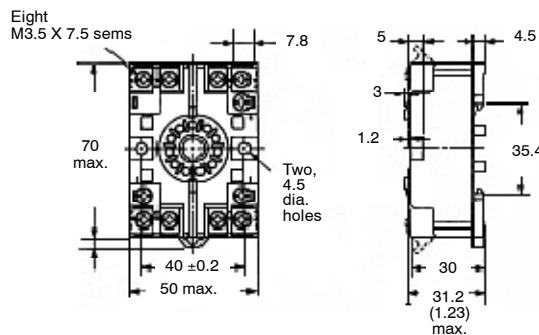

Back-Connecting Socket

P3G-08

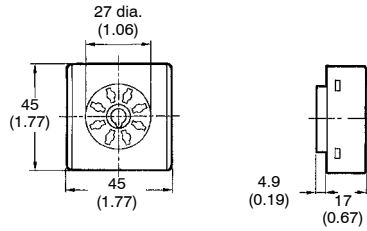
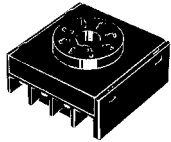

**Terminal Arrangement/
Internal Connections
(Bottom View)**

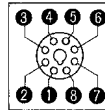

P3GA-11

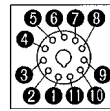
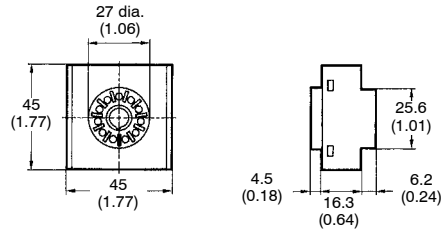
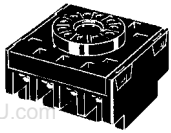

PROTECTIVE COVERS

Finger-Safe Terminal Cover for P3G(A)

Conforming to VDE0106/P100

Y92A-48G

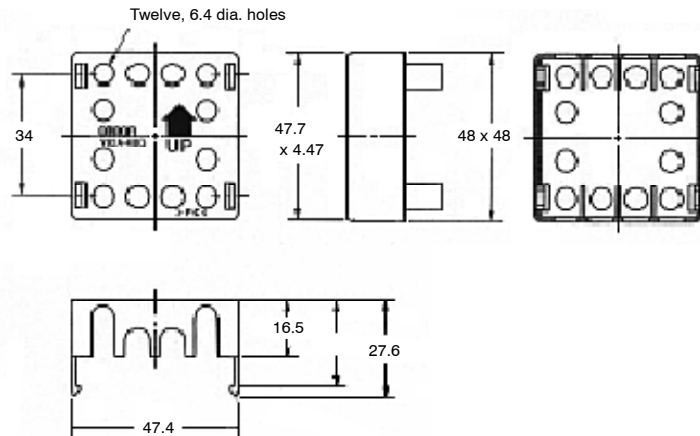
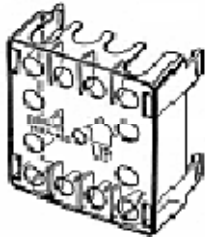

Y92A-48B

The protective cover protects the front panel, particularly the time setting section, against dust, dirt, and water. It also prevents the set value from being altered due to accidental contact with the time setting knob.

- Note:
1. The Y92A-48B Protective Cover is made of a hard plastic and therefore it must be removed to change the timer set value.
 2. The Protective Cover cannot be mounted if the Panel Cover (sold separately) is used on the Timer.
 3. When using a front cover for flush mounting, use the Y92F-30 Adapter. The Y92F-73 or Y92F-74 Flush Mounting Adapter cannot be used.

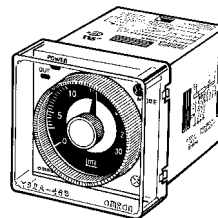

Y92A-48B

Time Setting Ring/Panel Cover

There are three colors of Panel Covers (Y92P-48GL (light gray), Y92P-48GB (black), and Y92P-48GM (medium gray). Use the most suitable type of Panel Cover with the design of the scaling plate according to the application.

When setting a given time for the Timer, use of the Y92S-27 or Y92S-28 Time Setting Ring facilitates the time setting operation and minimizes possible setting errors by operators.

The Y92F-73 or Y92F-74 Panel-Mounting Adapter or the Y92A-48B Protective Cover cannot be used.

The Time Setting Ring and Panel Cover should be used as a pair.

Setting a specific time	Time Setting Ring A (Y92S-27) and Panel Cover (Y92P-48GL, -48GB, or -48GM)
Limiting the setting range	Time Setting Ring B or C (Y92S-28), and Panel Cover (Y92P-48GL, -48GB, or -48GM)

Y92S-27
Time Setting A



Y92S-28
Time Setting B



Y92S-28
Time Setting C



Y92P-48GL
Light Gray

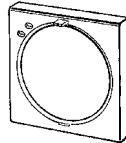

Y92P-48GB
Black

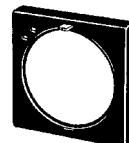

Y92P-48GM
Medium Gray

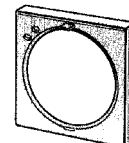

Hold-Down Clip

Y92H-7

For PL08 and PL11 Sockets

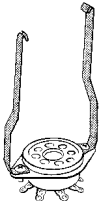

Y92H-8

For PF085A Socket

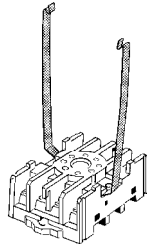

MOUNTING TRACK

PFP-100N, PFP-50N

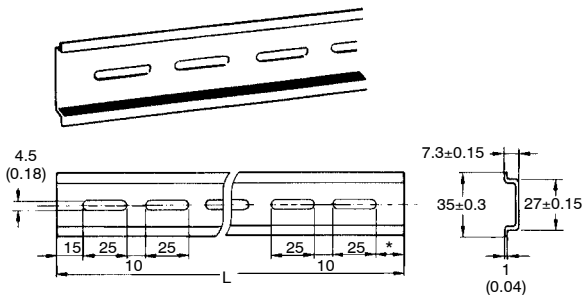

PFP-100N2

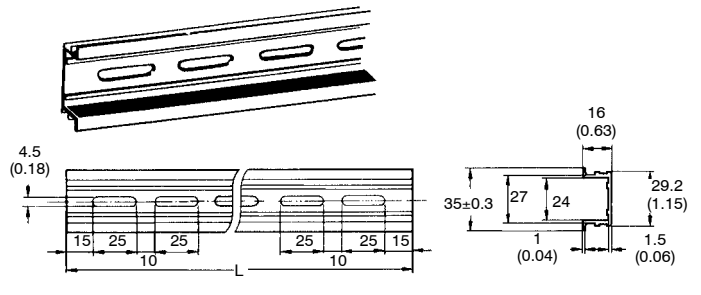

L: Length

1 m	PFP-100N
50 cm	PFP-50N
1 m	PFP-100N2

End Plate
PFP-M

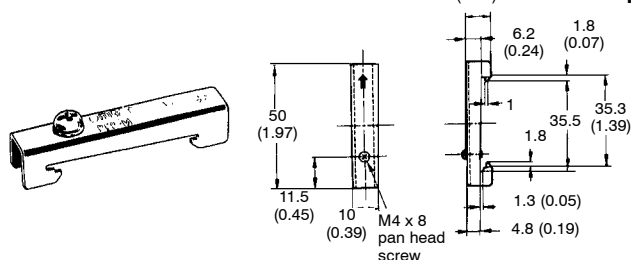

Spacer
PFP-S

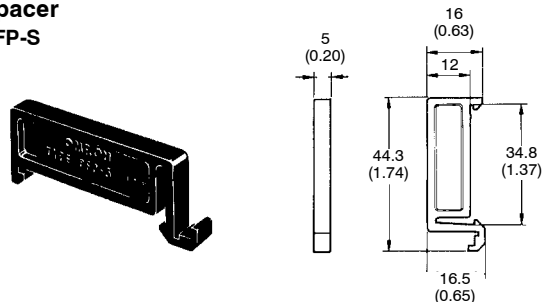

Connections

INPUT/OUTPUT FUNCTIONS

Models H3CR-A, H3CR-AP and H3CR-AS

Name	Type	Description
Start input*	No-voltage contact closure	Initiates timing
Reset input	No-voltage contact closure	Interrupts time measurement and resets the operation to start. No time measurement is made and the control output is OFF while the reset input is ON.
Gate input	No-voltage contact closure	Inhibits time measurement. Timing resumes when the gate input is turned OFF.
Control output	Relay or transistor	Turns ON and OFF when the preset value is reached, according to the operation mode selected.

Note: *H3CR-AP models offer Start input only and use a PNP voltage input.

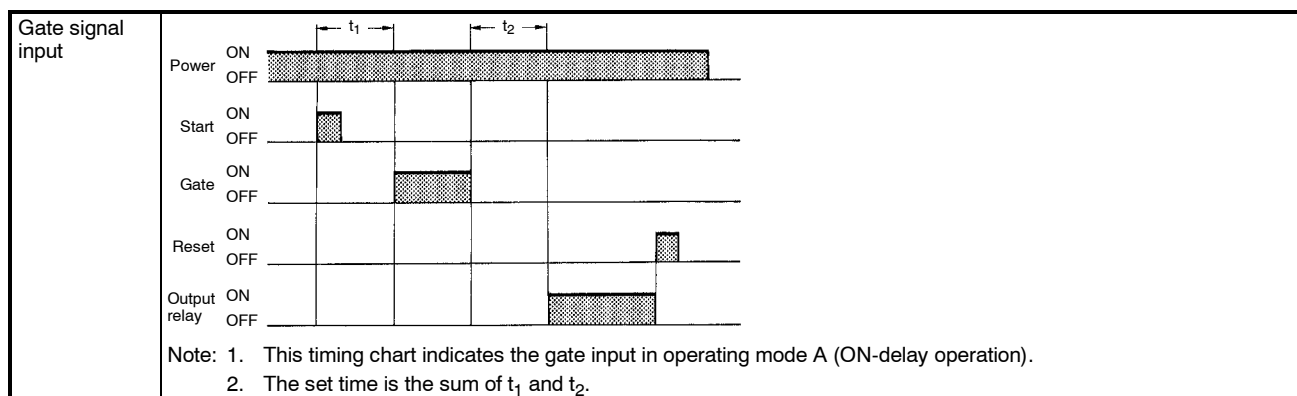

CONNECTION SUMMARY

Part number	Input terminal numbers				Power supply terminal numbers		Output terminal numbers			
	Gate	Start	Reset	0V	AC (common), DC-	AC (hot), DC+	Type	COM	NC	NO
H3CR-A	5	6	7	2	2	10	Timed contact	1	4	3
							Timed contact	11	8	9
H3CR-AP	--	6	--	7	2	10	Timed contact	1	4	3
							Timed contact	11	8	9
H3CR-AS	5	6	7	2	2	10	Transistor (NPN/PNP)	11	--	9
H3CR-A8	--	--	--	--	2	7	Timed contact	1	4	3
							Timed contact	8	5	6
H3CR-A8E	--	--	--	--	2	7	Timed contact	1	4	3
							Instantaneous contact	8	5	6
H3CR-A8S	--	--	--	--	2	7	Transistor (NPN/PNP)	8	--	6

■ TERMINAL ARRANGEMENT

Note: The delayed contact of conventional Timers was indicated as 

The contact symbol of the H3CR-A is indicated as  because its operating mode is five multi-modes (four multi-modes for the H3CR-A8).

11-pin Models

H3CR-A (Contact Output)

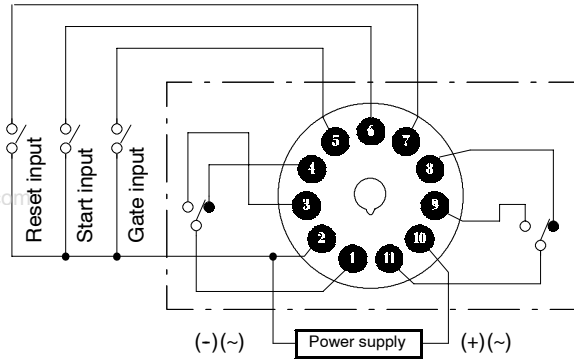

8-pin Models

H3CR-A8 (Contact Output)

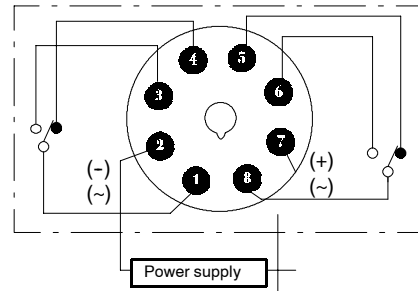

H3CR-AS (Transistor Output)

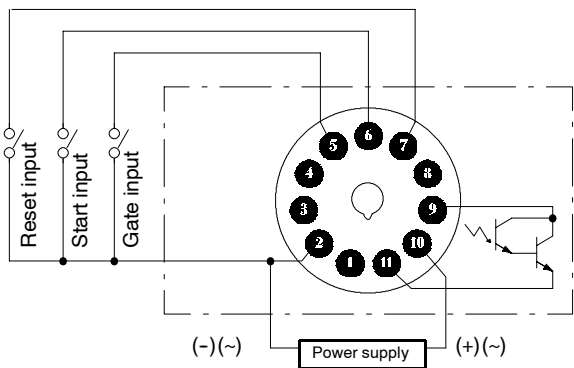

H3CR-A8S (Transistor Output)

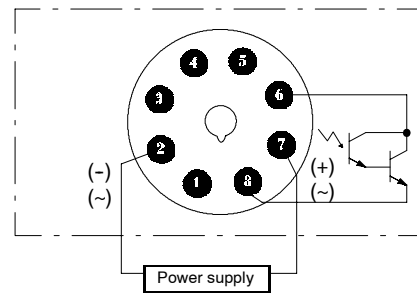

Note: Terminals 1, 3, 4, and 8 are empty. Terminals 2, 5, 6, 7, and 10 are the same as for the H3CR-A.

Note: Terminals 1, 3, 4, and 5 are empty. Terminals 2 and 7 are the same as for the H3CR-A8.

H3CR-AP (Contact Output)

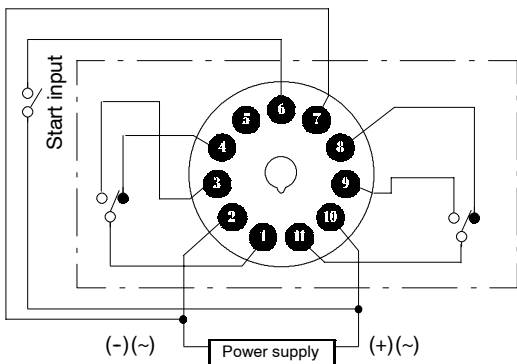

H3CR-A8E (Contact Output)

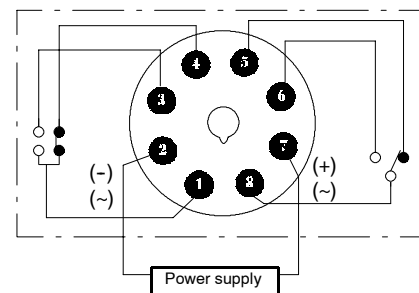

Note: Terminal 5 is empty.

INPUT CONNECTIONS

H3CR-A/-AS

The inputs of the H3CR-A/-AS are no-voltage (short-circuit or open) inputs.

No-voltage Inputs

No-contact Input

(Connection to NPN open collector output sensor.)

12 to 24 VDC
(sensor power supply)

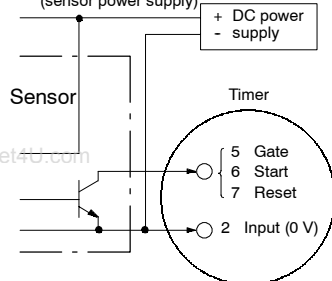

Operates with transistor ON

Contact Input

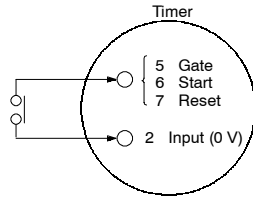

Operates with relay ON

No-contact Input

(Connection to a voltage output sensor.)

12 to 24 VDC
(sensor power supply)

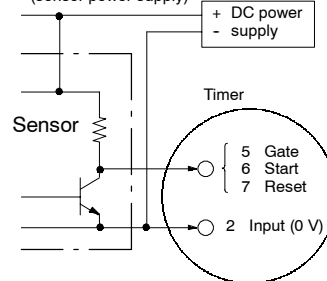

Operates with transistor ON

H3CR-AP

The start input of the H3CR-AP is voltage input. (Voltage imposition or open)

Voltage Inputs

No-contact Input

(Connection to PNP open collector output sensor)

12 to 24 VDC
(sensor power supply)

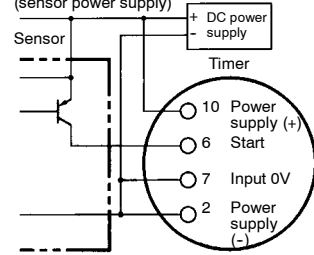

Operates with PNP transistor ON

No-contact Input

(Connection to NPN open collector output sensor)

12 to 24 VDC
(sensor power supply)

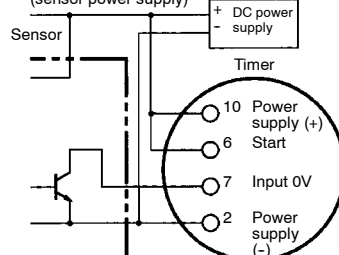

Operates with NPN transistor ON

Note: The input circuit is isolated from the power supply circuit. Thus, an NPN transistor can be connected.

Contact Input

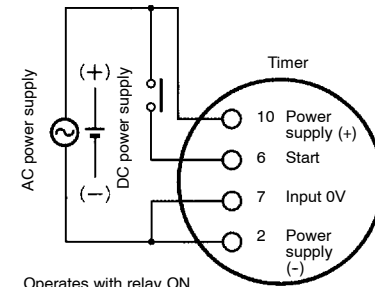

Operates with relay ON

Note: Refer to the signal levels in the following table and be aware of the minimum applicable load of the relay.

Installation

■ CHANGING THE SETTING

Do not change the time unit, time range, or operation mode while the Timer is in operation, or the Timer may malfunction.

The time unit and time range can be set with the respective selectors turned clockwise or counterclockwise.

The selectors are notched so that they will snap when they are properly set. Do not set the selectors midway between notches, or the Timer may break or malfunction.

■ POWER SUPPLIES

Pay the utmost attention not to make mistakes in polarity when wiring the Timer.

The H3CR Series uses a transformerless power supply. Do not touch the input terminals while the supply voltage is applied, or an electric shock may be received.

A DC power supply can be connected if its ripple factor is 20% or less and the mean voltage is within the rated operating voltage range of the Timer.

Be aware that the operating voltage will rise by 5% if the rated voltage is applied to the Timer continuously while the ambient temperature is close to the maximum permissible ambient temperature.

For the power supply of an input device of the H3CR-A/-AS, use an isolating transformer with the primary and secondary windings mutually isolated and the secondary winding not grounded.

Example: H3CR-A

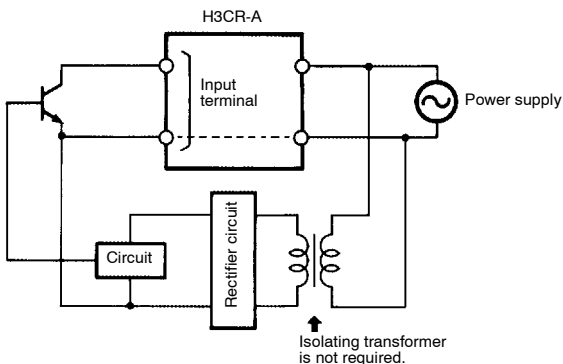

The power supply terminal 2 of H3CR-A/-AS is a common terminal for input signals to the Timer. Do not disconnect the wires on terminal 2, or the internal circuitry of the H3CR-A/-AS will be damaged.

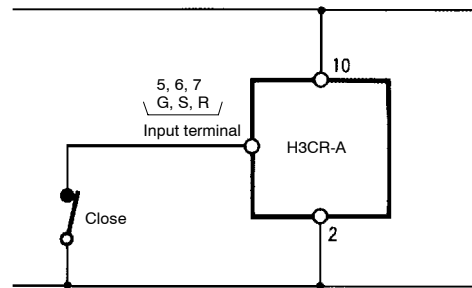

An AC power supply can be connected to the power input terminals without regard to polarity. A DC power supply must be connected to the power input terminals as designated according to the polarity of the terminals.

Make sure that the voltage is applied within the specified range, or the internal elements of the Timer may be damaged.

Connect the power supply voltage through a relay or switch in such a way that the voltage reaches a fixed value at once, or the Timer may not be reset, or a timer error may result.

INPUT/OUTPUT

Relationship between Input and Power Supply Circuits (H3CR-A/-AS)

The H3CR-A/-AS uses transformerless power supply. When connecting a relay or transistor as an external signal input device, pay attention to the following points to prevent short-circuiting due to a sneak current to the transformerless power supply. If a relay or transistor is connected to two or more Timers, the input terminals of those Timers must be wired properly so that they will not differ in phase, or the terminals will be short-circuited to one another.

Incorrect

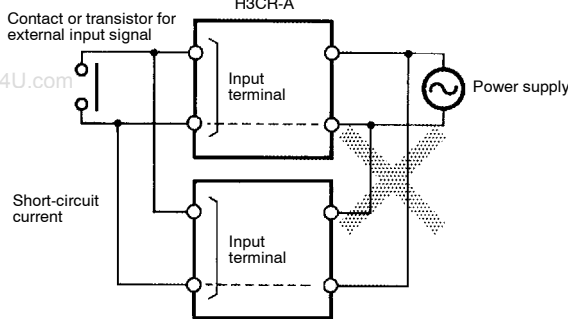

Correct

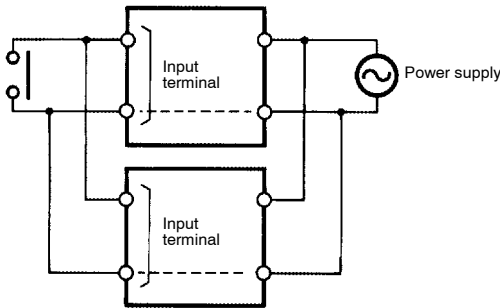

It is impossible to provide two independent power switches as shown below regardless of whether the Timers are different in phase.

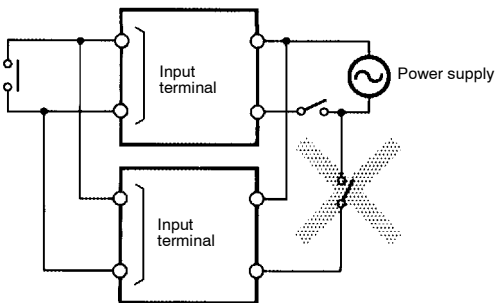

An appropriate input is applied to the input signal terminals of the H3CR-A/-AS when one of the input terminals is short-circuited with the common terminal (terminal 2) for the input signals. Do not attempt to connect the input terminal to any terminal other than the common terminal or to apply voltage across terminals other than the specified input and common terminals, or the internal circuitry of the Timer will be damaged.

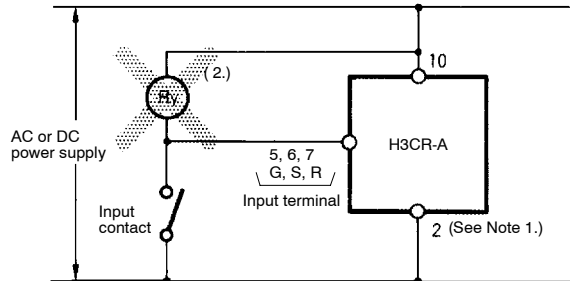

- Note: 1. Power supply terminal 2 is a common terminal for input signals to the Timer. Never use terminal 10 as the common terminal for this purpose, or the internal circuit of the Timer will be damaged.
- 2. Do not connect a relay or any other load between these terminals, or the internal circuit of the Timer will be damaged due to the high-tension voltage applied to the input terminals.

Relationship between Input and Power Supply Circuits (H3CR-AP)

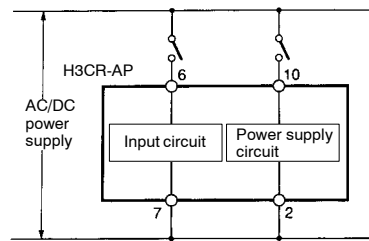

Since the input circuit and the power supply circuit are configured independently, the input circuit can be turned ON or OFF irrespective of the ON/OFF state of the power supply.

It must be noted that a voltage equivalent to the power supply voltage is applied to the input circuit.

When connecting a relay as an external signal input device, pay attention to the following points to prevent short-circuiting due to a sneak current to the transformerless power supply.

If a relay or transistor is connected to two or more Timers, the input terminals of those Timers must be wired properly so that they will not be different in phase or the terminals will be short-circuited to one another (refer to the figures below).

Incorrect Contact or transistor for external input signal

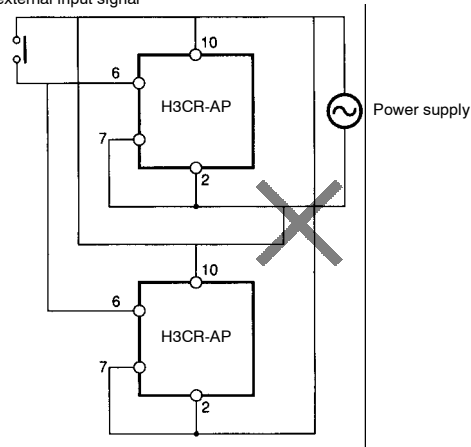

Correct Contact or transistor for external input signal

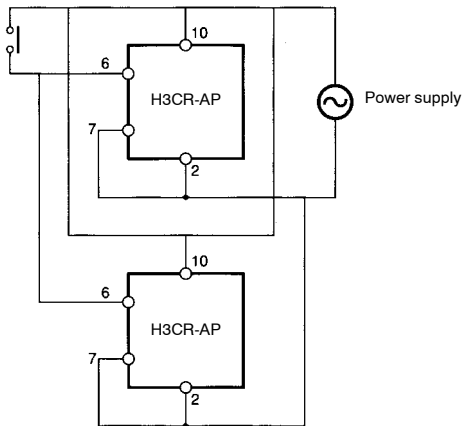

Common to All Models

The input wires must be as short as possible. If the floating capacity of wires exceeds 1,200 pF (approx. 10 m for cables with 120 pF/m), the operation will be affected. Pay particular attention when using shielded cables.

The H3CR-A□S transistor output is isolated from the internal circuitry by a photocoupler. Therefore, either NPN or PNP output is possible.

The power supply circuit of the H3CR-A Series (except for H3CR-A□S) is a switching circuit. If the power line connected to the power supply circuit has a transformer with high inductance, a counter-electromotive voltage will be induced. To suppress the voltage, apply a CR filter to the power supply line.

Do not set the dial to minimum in repeat cycle mode (B, B2) or the contacts may be damaged.

Operation

■ BASIC SETTING

Setting of Selector

The selectors can be turned clockwise and counterclockwise to select the desired time unit, time range, or operating mode.

Each selector has a snap mechanism that secures the selector at a given position. Set the selector at a position at which it is secured. Do not set it midway between two securing positions or a malfunction could result from improper setting.

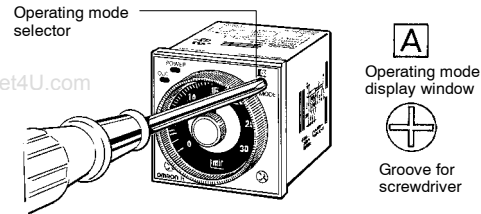

Selection of Operating Mode

Turn the operating mode selector with a screwdriver until the desired operating mode (H3CR-A/AP/AS: A, B, B2, C, D, or E, H3CR-A8/A8S/A8E: A, B2, E or J, H3CR-A-300: G or J) appears in the display window located above the selector.

Selection of Time Unit and Time Range

The desired time unit (sec, min, hrs, or 10h) is displayed in the window below the time setting knob by turning the time unit selector located at the lower right corner of the front panel. A time range (1.2, 3, 12, or 30/2.4, 6, 24, or 60 for H3CR-A□-301) is selected with the time range selector at the lower left corner of the front panel, and the selected time range appears (in the window at the lower right part) within the plastic frame of the time setting knob.

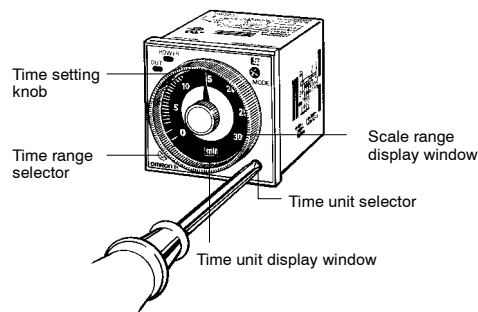

Setting of Time

Use the time setting knob to set the desired time.

■ TIME SETTING RINGS

Time setting rings allow the operator to lock in a selected, preset time. They must be used with Y92P Panel Covers. Each ring fits snugly around the time setting knob. A notch on the ring engages the tab on the panel cover to prevent setting knob travel. Omron offers two types of time setting rings in medium gray. The Y92S-27 setting ring is used for a single set point. The Y92S-28 pair of rings are used to lock in two set points for a timing range.

Y92S-27 Setting a Single Preset

In this example, the time setting will be locked at 10 minutes: Select timing function and set unit of measure to "min". Install the panel cover. Turn the time setting knob to 10. Align the notch on the ring with the tab then press the ring onto the time setting knob.

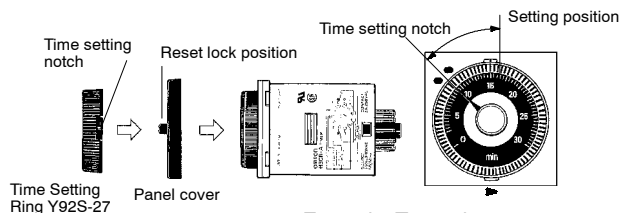

Example: To set the time to 10 s.

Y92S-28 Limiting the Setting Range

In this example, the timing range of 10 to 20 minutes will be locked in using the two rings in Y92S-28: Set the timing function and set unit of measure to "min". Turn the setting knob to 10. Align the thinner ring's tab with the right side of the panel cover tab. Press the ring onto the time setting knob to set the lower limit. Turn the time setting knob to 20. Align the thicker ring's tab with the left side of the panel cover tab. Press the ring onto the time setting knob to set the upper limit.

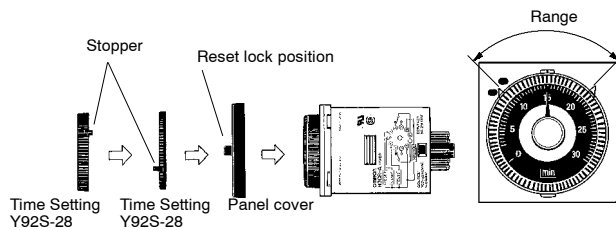

Mounting

■ PANEL MOUNTING

Using Y92F-30 Adapter

Insert the timer through the panel cutout. Push the Y92F-30 adapter from the rear of the timer as far forward toward the panel as possible. Wire the P3G□□ socket, then push it onto the rear of the timer. Then tighten the two retaining screws. To release the adapter, lift the tab at the rear of the adapter.

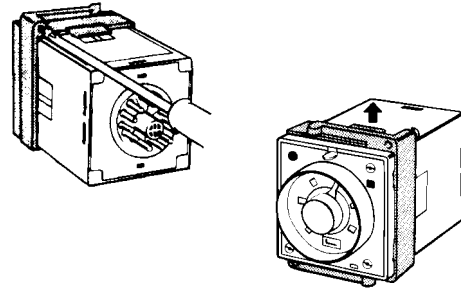

www.DataSheet4U.com

Several timers may be panel mounted close together using Y92F-30 adapter as shown here. When mounting two or more timers in a vertical line, arrange the adapters so that their molded tabs are positioned on the right and left sides. When mounting two or more timers in a horizontal line, arrange the adapters so that their molded tabs are positioned on the top and bottom sides.

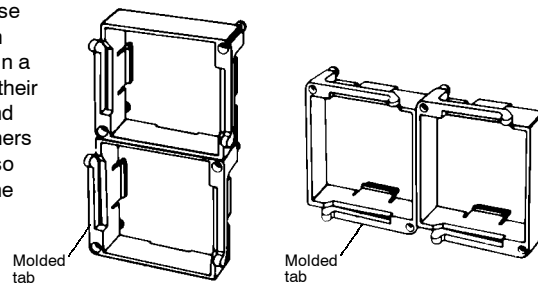

Panel cutout for side-by-side mounting of two timers

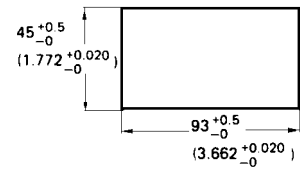

■ TRACK MOUNTING

Using P2CF-□□ Socket

Mounting

The P2CF-□□ socket has two hooks that secure the timer to the socket. Be sure to allow at least 20 mm (0.79 in) clearance above and below the socket to gain access and to release the hooks for servicing and maintenance. Insert timer into the socket. Latch hooks. Then clip rear of the socket to the track. Push the bottom onto the track until the latch hooks securely.

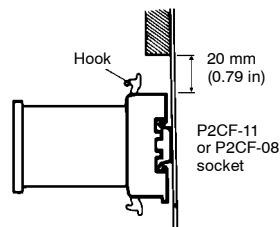

Removal

Pull the latch on the socket with a flat-blade screwdriver and remove the timer and socket as one unit.

Precautions

■ OPERATING ENVIRONMENT

Do not use the Timer in the following locations.

- Locations with radical temperature changes.
- Locations with high humidity that may result in condensation.
- Locations with excessive vibration or shock.
- Locations with corrosive gas or dust.
- Locations where the Timer is exposed to sprayed water, oil, or chemicals.

Organic solvents (such as paint thinner) as well as strong acid or alkali solutions will damage the outer casing of the Timer.

If the Timer is used in an area with excessive electrical noise, be sure to separate the Timer, wires, and input device as far as possible from the noise sources. Shield the input signal wiring to prevent electrical interference.

■ VOLTAGE WITHSTAND TEST

If the Timer is mounted to a control board, remove the Timer from the control board or short-circuit the control board circuitry before carrying out a voltage withstand test between the electric circuitry and non-charged metal part of the Timer. This protects the internal circuitry of the Timer from damage.

■ PRECAUTIONS FOR EN (VDE) CONFORMANCE

The H3CR-A Series, installed as a built-in timer, conforms to EN61812-1 (VDE0435/P2021) provided that the following conditions are satisfied.

Make sure that no voltage is applied to any terminals before removing the Timer from the Socket.

The output section of the H3CR-A is provided only with basic isolation. Provide supplementary basic isolation on the load side connected to the output so that reinforced isolation required by the EN (VDE) standards will be ensured.

The H3CR-A itself is designed under the following conditions:

- Overvoltage category III
- Pollution degree 2
- Isolation

Operation parts: Reinforced isolation

With clearance of 5.5 mm and creepage distance of 5.5 mm at 230 VAC

Output: Basic isolation (See Note.)

With clearance of 3 mm and creepage distance of 3 mm at 230 VAC

Note: The 11-pin model ensures basic isolation by itself and also ensures basic isolation with the 11-pin model mounted to the OMRON P2CF-11 or P3GA-11 Socket.

Connect the two output contacts different in polarity to the loads so that they will be the same in potential.

NOTE: DIMENSIONS SHOWN ARE IN MILLIMETERS. To convert millimeters to inches divide by 25.4.

OMRON®

OMRON ELECTRONICS LLC

One East Commerce Drive
Schaumburg, IL 60173

1-800-55-OMRON

OMRON ON-LINE

Global - <http://www.omron.com>
USA - <http://www.omron.com/oei>
Canada - <http://www.omron.com/oci>

OMRON CANADA, INC.

885 Milner Avenue
Scarborough, Ontario M1B 5V8

416-286-6465