

CUSTOMER APPROVAL SHEET

Company Name (請註明客戶別)

MODEL **IEH497TLB01.0**

CUSTOMER **Title :**

APPROVED **Name :**

- APPROVAL FOR SPECIFICATIONS ONLY (Spec. Ver. _____)**
- APPROVAL FOR SPECIFICATIONS AND ES SAMPLE (Spec. Ver. _____)**
- APPROVAL FOR SPECIFICATIONS AND CS SAMPLE (Spec. Ver. _____)**
- CUSTOMER REMARK :**

Doc. version :	0.6
Total pages :	30
Date :	2014/1/08

Product Specification

5.0" COLOR AMOLED MODULE

MODEL NAME: H497TLB01.0

P/N: 95.04H60.000

< ◆ >Preliminary Specification
< >Final Specification

Note: The content of this specification is subject to change.

Record of Revision

Version	Revise Date	Page	Content
0.0	Aug. 23, 2013		First Draft
0.1	Aug. 28, 2013		Add EE setting
0.2	Oct. 16, 2013		Spec. modified.
0.3	Nov. 6, 2013	15,16,18, 21	Change the Power on sequence and Power off sequence.
0.4	Nov. 28, 2013	18 ~ 21	Change Initial code.
0.5	Dec. 13, 2013	18 ~ 21 29~30,	Add VESA standard / Change power consumption & initial code/ Module drawing
0.6	Jan. 08, 2014	6	Revised pin 27 MIPI DSI data3+, pin 28 MIPI DSI data3-
0.7	Apr, 02, 2014	21	Add description on Display Timing

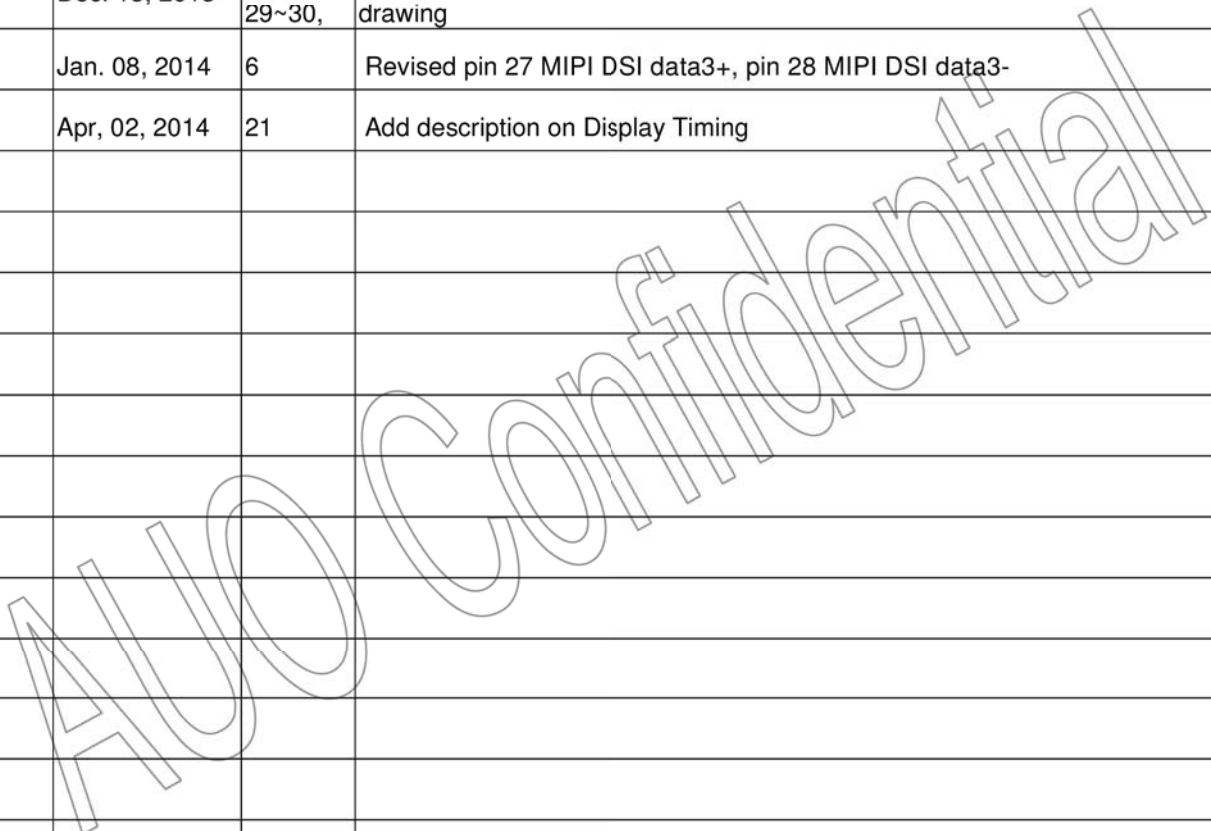

Contents

A. General Specification	4
1. Physical Specifications	4
2. Module Block Diagram	4
3. Driver IC Block Diagram	5
B. Electrical Specifications	6
1. Main FPC Pin assignment — AMOLED Panel Input/Output Signal Interface	6
2. Absolute maximum ratings	7
C. Electrical Characteristics	8
1. Typical Operating Conditions	8
2. Display Current Consumption	8
3. Touch Panel Current Consumption	9
D. AC Characteristics	10
1. MIPI Interface Characteristics	10
2. Display RESET Timing Characteristics	12
3. Touch Panel I2C Timing Characteristics	13
4. Touch Panel RESET Timing Characteristics	14
E. Recommended Operating Sequence	15
1. State Diagram	15
2. Display Power on / off Sequence	15
3. Touch Panel Power on Sequence	17
F. Display and Touch Initial code	18
1. Display Timing and Initial code and	18
2. Touch Panel IIC address	19
G. Specifications	22
H. Reliability Test Items	27
I. Packing	28
J. Outline Demension (Tentative)	29

A. General Specification

1. Physical Specifications

Item	Description	Single LCM	Remark
1	Screen Size (inch)	4.97"	
2	Driving Method	DC	
3	Display Mode	OLED	
4	Display Resolution (dot)	720xRGBx1280	
5	Active Area (mm)	61.92 (H)×110.08(V)	
6	Pixel Configuration	Real R.G.B	
7	Display Color	16.7M	
8	Driver IC	RM69052	Raydium
9	Interface	MIPI DSI	
10	Touch IC	S3402	Synaptics
11	Outline Dimension (mm)	65.92 (H) × 118.64(V) × 1.00(T)	AMOLED w/ on-cell touch function

2. Module Block Diagram

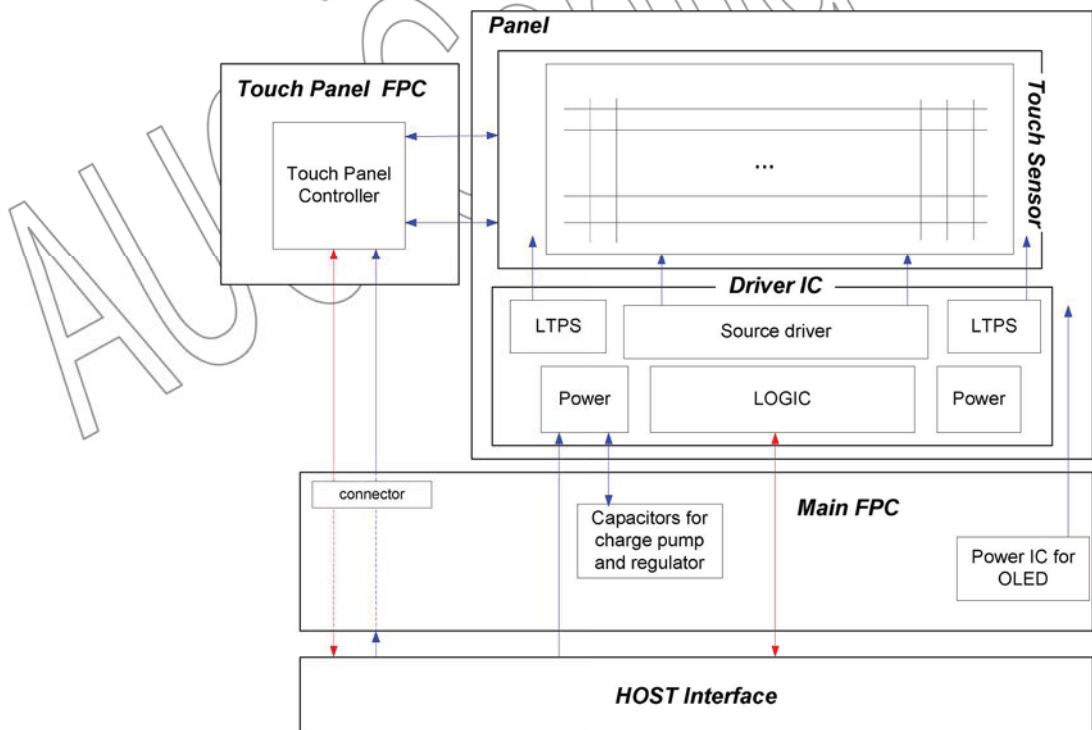

3. Driver IC Block Diagram

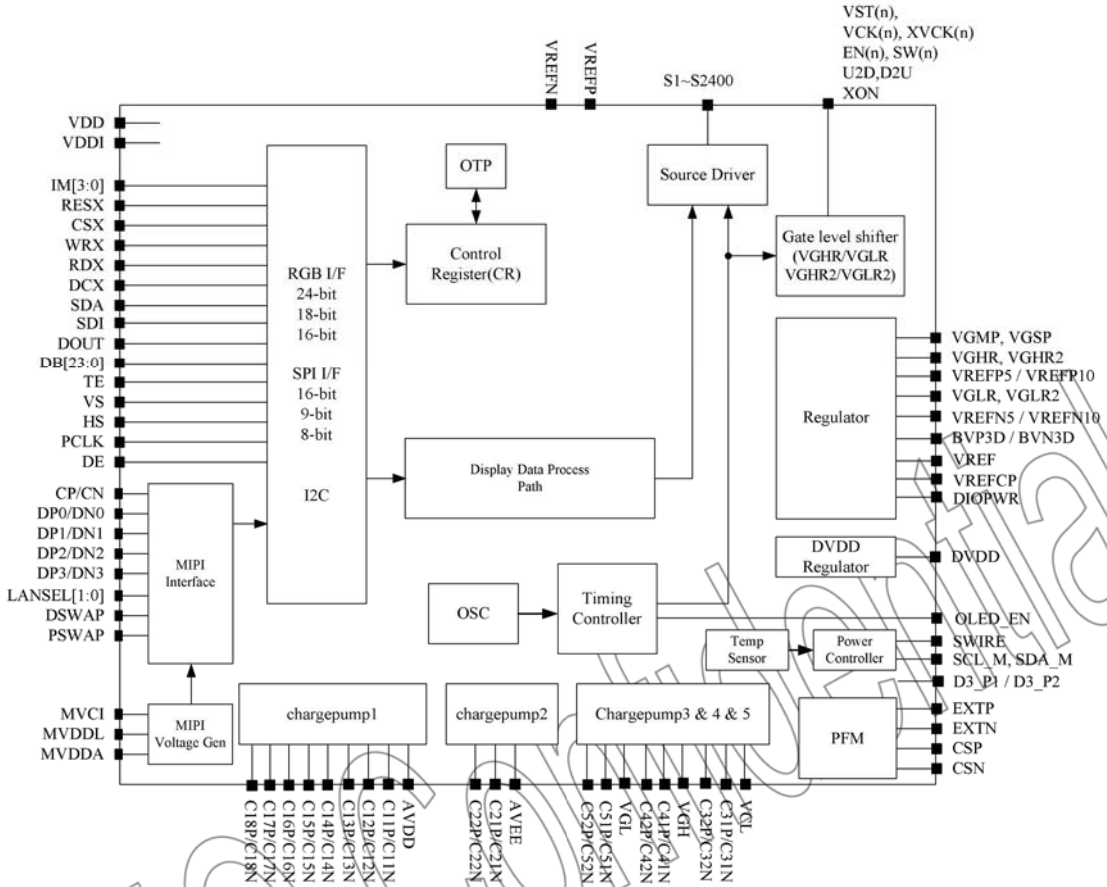

B. Electrical Specifications

1. Main FPC Pin assignment — AMOLED Panel Input/Output Signal Interface

Recommended connector: FH26-39S-0.3SHW (Hirose)

#	Pin_name	I/O	Description
1	GND	Power	Ground
2	VBAT	Power	
3	VBAT	Power	
4	VBAT	Power	
5	VBAT	Power	
6	VBAT	Power	
7	GND	Power	Ground
8	GND	Power	Ground
9	GND	Power	Ground
10	NC	NC	
11	TE		
12	RESX	I	This signal will reset the device and must be applied to properly initialize the chip. Signal is active low.
13	VDDI	Power	Driver IC digital I/O supply
14	GND	Power	Ground
15	D2P	I	MIPI DSI data2+
16	D2N	I	MIPI DSI data2-
17	GND	Power	Ground
18	D1P	I	MIPI DSI data1+
19	D1N	I	MIPI DSI data1-
20	GND	Power	Ground
21	CKP	I	MIPI DSI clock+
22	CKN	I	MIPI DSI clock-
23	GND	Power	Ground
24	D0P	I/O	MIPI DSI data0+
25	D0N	I/O	MIPI DSI data0-
26	GND	Power	Ground
27	D3P	I	MIPI DSI data3+
28	D3N	I	MIPI DSI data3-
29	GND	Power	Ground
30	VCI	Power	Driver IC analog supply
31	GND	Power	Ground
32	TP_VCC	Power	Touch panel analog supply (connect to touch FPC pin6)
33	TP_VDDI	Power	Touch Panel I/O voltage supply (connect to touch FPC pin7)
34	TP_INT	O	Touch panel interrupt output (connect to touch FPC pin8)
35	TP_SDA	I/O	Touch panel I2C data (connect to touch FPC pin10)
36	TP_SCL	I/O	Touch panel I2C clock (connect to touch FPC pin9)
37	TP_RESX	O	Touch panel reset (connect to touch FPC pin11)
38	TP_A4	I/O	Touch panel reserved GPIO (connect to touch FPC pin12)
39	GND	Power	Ground

2. Absolute maximum ratings

Item	Symbol	Min.	Max.	Unit	Remark
Power IC Power supply	VBAT	-	+4.5	V	
Digital Power supply	VDDI	-0.3	+2.0	V	
Analog Power supply	VCI	-0.3	+4.0	V	
Touch analog power supply	TP_VCC	-0.3	+4.0	V	
Touch digital power supply	TP_VDDI	-0.3	+2.0	V	

Note : If the module exceeds the absolute maximum ratings, it may be damaged permanently. Also, if the module operates with the absolute maximum ratings for a long time, the reliability may drop.

C. Electrical Characteristics

1. Typical Operating Conditions

Item	Symbol	Min.	Typ.	Max.	Unit	Remark	
Panel Power supply	VBAT	2.9	3.7	4.5	V		
Digital Power supply	VDDI	1.65	1.8	1.95	V		
Analog Power supply	VCI	2.7	3.1	3.6	V		
Touch analog power supply	TP_VCC	2.7	3.1	3.6	V		
Touch digital power supply	TP_VDDI	1.65	1.8	1.95	V		
Input Signal Voltage	H Level	V_{IH}	$0.8 \cdot VDDI$	-	VDDI	V	RESX
	L Level	V_{IL}	0	-	$0.2 \cdot VDDI$	V	
Output Signal Voltage	H Level	V_{OH}	$0.7 \cdot VDDI$	-	VDDI	V	TE
	L Level	V_{OL}	0	-	$0.3 \cdot VDDI$	V	

Note 1: The operation is guaranteed under the recommended operating conditions only. The operation is not guaranteed if a quick voltage change occurs during the operation. To prevent the noise, a bypass capacitor must be inserted into the line closed to the power pin.

2. Display Current Consumption

Mode	Symbol	Condition	Min.	Typ.	Max.	Unit	Remark
Normal	I_{BAT}	$V_{BAT} = 3.7V$	-	470	580	mA	Note1
	I_{VCI}		-	60	80	mA	Note2
	I_{VDDI}		-	1	10	mA	Note2
Deep Standby (DSTB=1)	$I_{OVDD/OVSS}$	$VDDI = 1.8V$	-	<1	-	mA	Note3
	I_{VCI}		-	<1	-	mA	Note3
	I_{VDDI}		-	<1	-	μA	Note3

Note 1: VBAT input 2.9V, I_{BAT} maximum current enhance to 740mA.

Note 2: Testing in white pattern. MIPI-DSI frame rate 60Hz video mode.

Note 3: Display off. RESX = high

3. Touch Panel Current Consumption

Mode	Symbol	Condition	Typ.	Unit	Remark
(Active – 1finger)	I _{TP_VDDI}	TP_VDDI = 1.8V	13	mA	
	I _{TP_VCC}	TP_VCC=3.1V	12.5	mA	
(Active – 10fingers)	I _{TP_VDDI}	Touch controller configured at 100 Hz report rate and 30 ms doze interval (24Rx x 14Tx)	18.5	mA	
	I _{TP_VCC}		12.5	mA	
Normal Operation	I _{TP_VDDI}		0.4	mA	
	I _{TP_VCC}		0.35	mA	
Sensor Sleep (Deep sleep)	I _{TP_VDDI}	I _{TP_VDDI} not include VBUS	9	μA	
	I _{TP_VCC}		8	μA	

AUO Confidential

D. AC Characteristics

1. MIPI Interface Characteristics

HS Data Transmission Burst

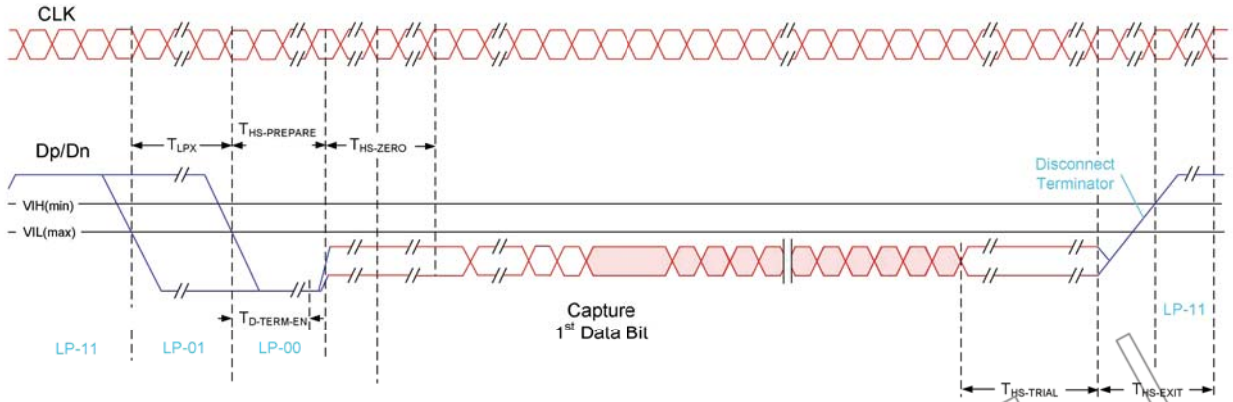

HS clock transmission

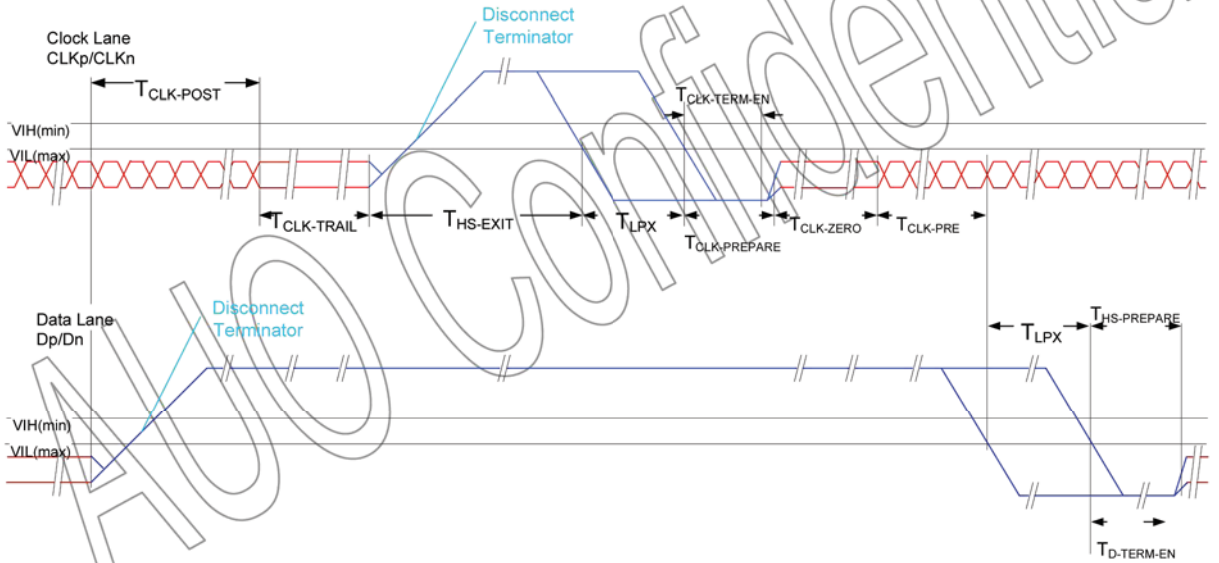

Turnaround Procedure

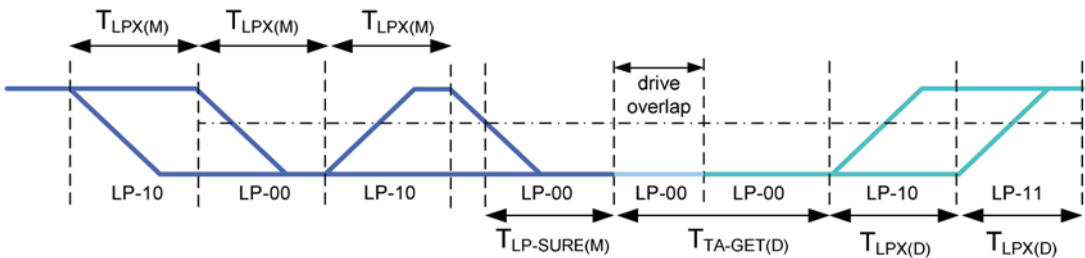

Timing Parameters

Symbol	Description	Min	Typ	Max	Unit
$T_{\text{CLK-POST}}$	Time that the transmitter continues to send HS clock after the last associated Data Lane has transitioned to LP Mode. Interval is defined as the period from the end of $T_{\text{HS-TRAIL}}$ to the beginning of $T_{\text{CLK-TRAIL}}$.	$60\text{ns} + 52*UI$			ns
$T_{\text{CLK-TRAIL}}$	Time that the transmitter drives the HS-0 state after the last payload clock bit of a HS transmission burst.	60			ns
$T_{\text{HS-EXIT}}$	Time that the transmitter drives LP-11 following a HS burst.	300			ns
$T_{\text{CLK-TERM-EN}}$	Time for the Clock Lane receiver to enable the HS line termination, starting from the time point when Dn crosses $V_{\text{IL,MAX}}$.	Time for Dn to reach $V_{\text{TERM-EN}}$		38	ns
$T_{\text{CLK-PREPARE}}$	Time that the transmitter drives the Clock Lane LP-00 Line state immediately before the HS-0 Line state starting the HS transmission.	38		95	ns
$T_{\text{CLK-PRE}}$	Time that the HS clock shall be driven by the transmitter prior to any associated Data Lane beginning the transition from LP to HS mode.	8			UI
$T_{\text{CLK-PREPARE}} + T_{\text{CLK-ZERO}}$	$T_{\text{CLK-PREPARE}}$ + time that the transmitter drives the HS-0 state prior to starting the Clock.	300			ns
$T_{\text{D-TERM-EN}}$	Time for the Data Lane receiver to enable the HS line termination, starting from the time point when Dn crosses $V_{\text{IL,MAX}}$.	Time for Dn to reach $V_{\text{TERM-EN}}$		$35\text{ ns} + 4*UI$	
$T_{\text{HS-PREPARE}}$	Time that the transmitter drives the Data Lane LP-00 Line state immediately before the HS-0 Line state starting the HS transmission	$40\text{ns} + 4*UI$		$85\text{ ns} + 6*UI$	ns
$T_{\text{HS-PREPARE}} + T_{\text{HS-ZERO}}$	$T_{\text{HS-PREPARE}}$ + time that the transmitter drives the HS-0 state prior to transmitting the Sync sequence.	$145\text{ns} + 10*UI$			ns
$T_{\text{HS-TRAIL}}$	Time that the transmitter drives the flipped differential state after last payload data bit of a HS transmission burst	$60\text{ns} + 4*UI$			ns
$T_{\text{LPX(M)}}$	Transmitted length of any Low-Power state	50		150	ns

	period of MCU to display module				
$T_{TA-SURE(M)}$	Time that the display module waits after the LP-10 state before transmitting the Bridge state (LP-00) during a Link Turnaround.	$T_{LPX(M)}$		$2 * T_{LPX(M)}$	ns
$T_{LPX(D)}$	Transmitted length of any Low-Power state period of display module to MCU	50		150	ns
$T_{TA-GET(D)}$	Time that the display module drives the Bridge state (LP-00) after accepting control during a Link Turnaround.	$5 * T_{LPX(D)}$			ns
$T_{TA-GO(D)}$	Time that the display module drives the Bridge state (LP-00) before releasing control during a Link Turnaround.	$4 * T_{LPX(D)}$			ns
$T_{TA-SURE(D)}$	Time that the MPU waits after the LP-10 state before transmitting the Bridge state (LP-00) during a Link Turnaround.	$T_{LPX(D)}$		$2 * T_{LPX(D)}$	ns

2. Display RESET Timing Characteristics

Reset input timing

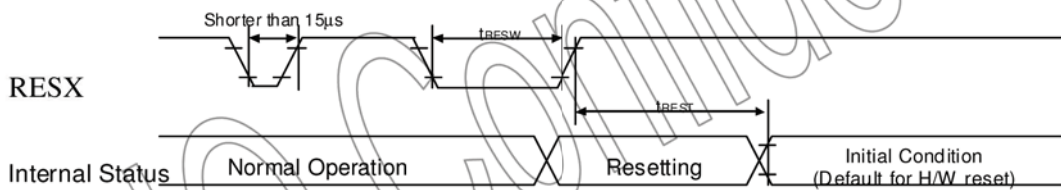

IOVCC=1.65 to 3.6V, VCI=2.5 to 3.6V, AGND=DGND=0V, Ta=-40 to 85°C

Timing Parameters

Symbol	Parameter	Related Pins	MIN	TYP	MAX	Note	Unit
t_{RESW}	*1) Reset low pulse width	RESX	15	-	-	-	μs
t_{REST}	*2) Reset complete time	-	-	-	5	When reset applied during Sleep in mode	ms
		-	-	-	120	When reset applied during Sleep out mode	ms

Note 1. Spike due to an electrostatic discharge on RESX line does not cause irregular system reset according to the table below.

RESX Pulse	Action
Shorter than 5 μs	Reset Rejected
Longer than 15 μs	Reset
Between 5 μs and 15 μs	Reset starts (It depends on voltage and temperature condition.)

Note 2. During the resetting period, the display will be blanked (The display is entering blanking

sequence, which maximum time is 120 ms, when Reset Starts in Sleep Out –mode. The display remains the blank state in Sleep In –mode) and then return to Default condition for H/W reset.

Note 3. During Reset Complete Time, data in OTP will be latched to internal register during this period. This loading is done every time when there is H/W reset complete time (t_{REST}) within 5ms after a rising edge of RESX.

Note 4. Spike Rejection also applies during a valid reset pulse as shown below:

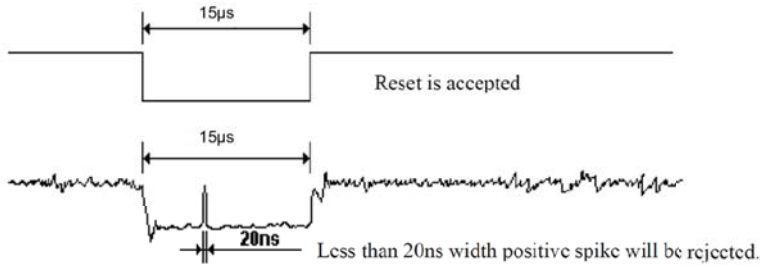

Note 5. It is necessary to wait 5msec after releasing RESX before sending commands. Also Sleep Out command cannot be sent for 120msec.

3. Touch Panel I2C Timing Characteristics

I2C timing

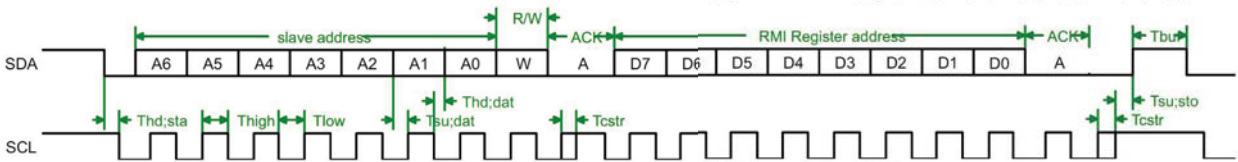

Timing Parameters

Symbol	Parameter	Standard- Mode Host		Fast-Mode Host		Unit
		Min.	Max.	Min.	Max.	
fSCL	SCL clock frequency	-	100	-	400	kHz
tCSTR	Stretch time	-	25	-	25	µs
tHD;STA	Hold time (repeated) START condition. After this period, the first clock pulse is generated.	4.0	-	0.6	-	µs
tLOW	LOW period of the SCL clock	4.7	-	1.3	-	µs
tHIGH	HIGH period of the SCL clock	4.0	-	0.6	-	µs
tSU;STA	Set-up time for a repeated START condition	4.7	-	0.6	-	µs
tHD;DAT	Data hold time	0	3.45	0	0.9	µs
tHD;DAT O	Data out hold time	-	0	-	0	µs
tSU;DAT	Data set-up time	250	-	100	-	ns
tr	Rise time of both SDA and SCL signals	-	1000	20 + 0.1 Cb	300	ns
tf	Fall time of both SDA and SCL signals	-	3000	20 + 0.1 Cb	300	ns
tSU;STO	Set-up time for STOP condition	4.0	-	0.6	-	µs

tBUF	Bus free time between a STOP and START condition	4.7	-	1.3	-	μs
Cb	Capacitive load for each bus line	-	400	-	400	pF
VnL	Noise margin at the LOW level for each connected device (including hysteresis)	0.1 VBUS		0.1 VBUS		V
VnH	Noise margin at the HIGH level for each connected device (including hysteresis)	0.2 VBUS	-	0.2 VBUS	-	V

4. Touch Panel RESET Timing Characteristics

Reset input timing

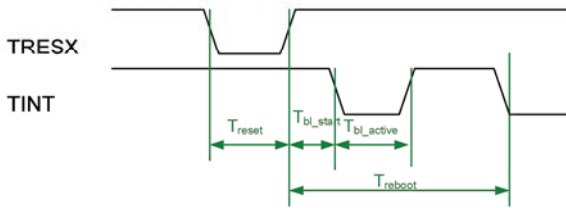

Timing Parameters

Symbol	Min.	Max.	Unit
T_{reset} (TRESX pin)	100	-	ns
$T_{\text{bl_start}}$	-	2	ms
$T_{\text{bl_active}}$	-	11	ms
T_{reboot}	-	16	ms

E. Recommended Operating Sequence

1. State Diagram

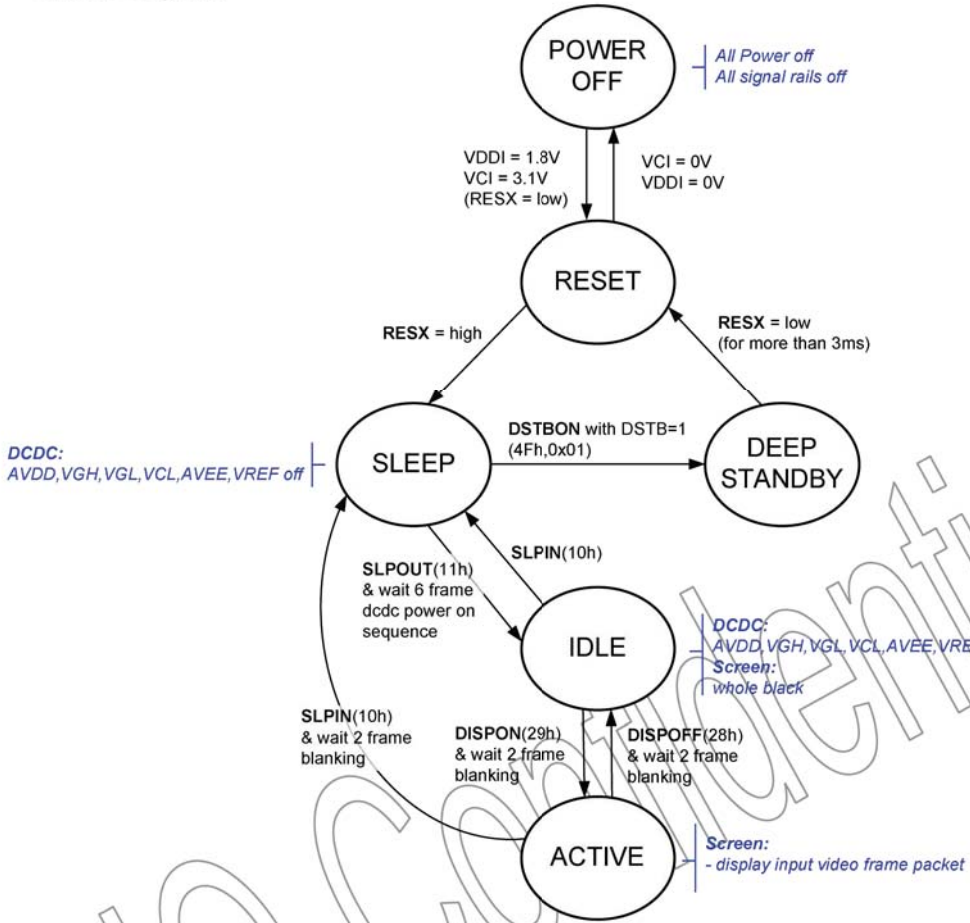

2. Display Power on / off Sequence

Power On Sequence:

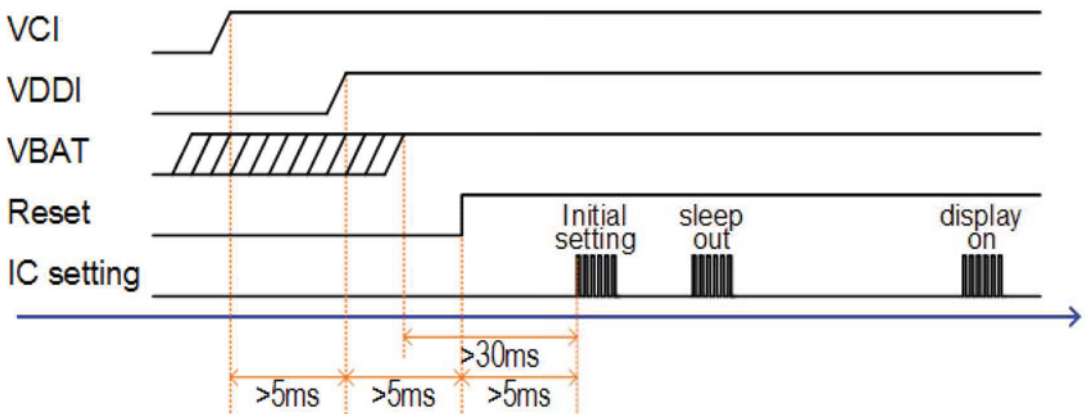

Power Off Sequence:

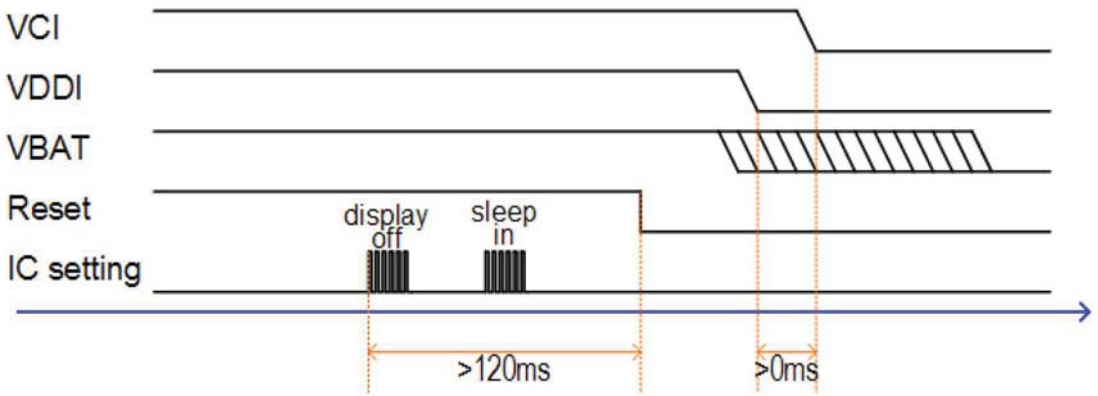

Power On Sequence

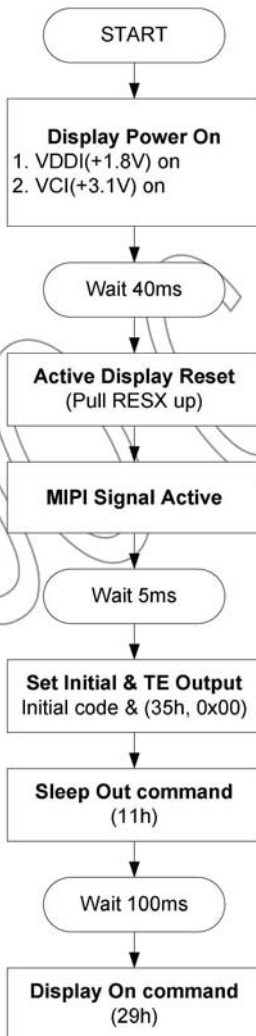

Power Off Sequence

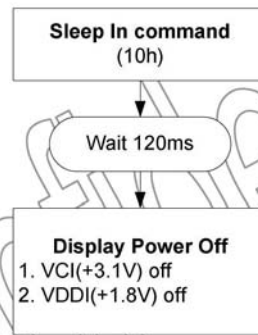

3. Touch Panel Power on Sequence

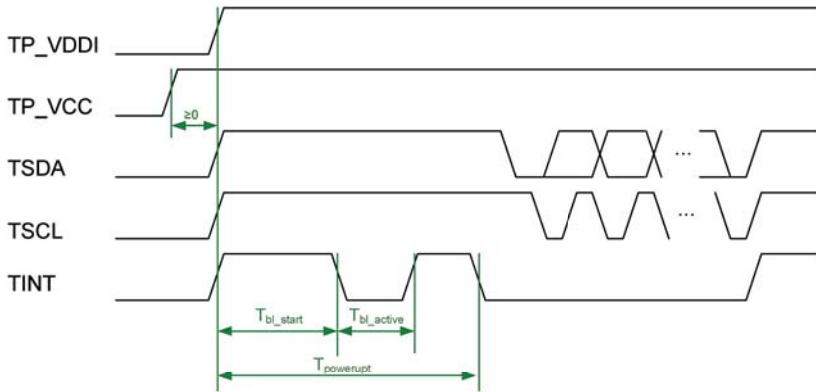

Symbol	Min.	Max.	Unit
$T_{powerup}$	-	60	ms
T_{bl_start} (bootloader start)	-	46	ms
T_{bl_active} (bootloader active)	-	11	ms

F. Display and Touch Initial code

Display Initial code

Item	Parameter qt'y	address	P0	P1	P2	P3	P4	P5	P6	P7	P8	P9	P10
1	5	F0	55	AA	52	08	00						
2	3	B0	00	10	10								
3	1	BA	60										
4	7	BB	77	77	77	77	77	77	77				
5	5	F0	55	AA	52	08	02						
6	1	CA	04										
7	1	E1	00										
8	1	E2	0A										
9	1	E3	40										
10	4	E7	00	00	00	00							
11	8	ED	48	00	E0	13	08	00	91	08			
12	6	FD	00	08	1C	00	00	01					
13	11	C3	11	24	04	0A	02	04	00	1C	10	F0	00
14	5	F0	55	AA	52	08	03						
15	1	E0	00										
16	6	F1	00	00	00	00	00	01					
17	1	F6	08										
18	5	F0	55	AA	52	08	05						
19	2	C4	00	14									
20	1	C9	04										
21	5	F0	55	AA	52	08	01						
22	3	B0	06	06	06								
23	3	B1	14	14	14								
24	3	B2	00	00	00								
25	3	B4	66	66	66								
26	3	B5	44	44	44								
27	3	B6	54	54	54								
28	3	B7	24	24	24								
29	3	B9	04	04	04								
30	3	BA	14	14	14								
31	3	BE	22	38	78								
32	1	35	00										

1. Touch Panel IIC address

Reading Manufacturer ID :

IIC address (7 bits) = 0x20

Although a host would not normally need to read the Manufacturer ID register provided by the RMI4 interface, reading this register is a good first step in verifying that the host and

Touch Controller are communicating :

The Manufacturer ID register belongs to the group of Function \$01 query registers. The addresses of these registers vary between different Synaptics RMI4-over-I2C Touch Controllers.

The Manufacturer ID register always returns data \$01. Figure A gives an example of the resulting bus transaction, in the format typically used to describe I2C transactions. The symbol meanings are listed in Table A. The shaded areas indicate bus activity by the Touch Controller. In this example, assume the slave address of the device is \$20, with the Manufacturer ID register at \$E1.

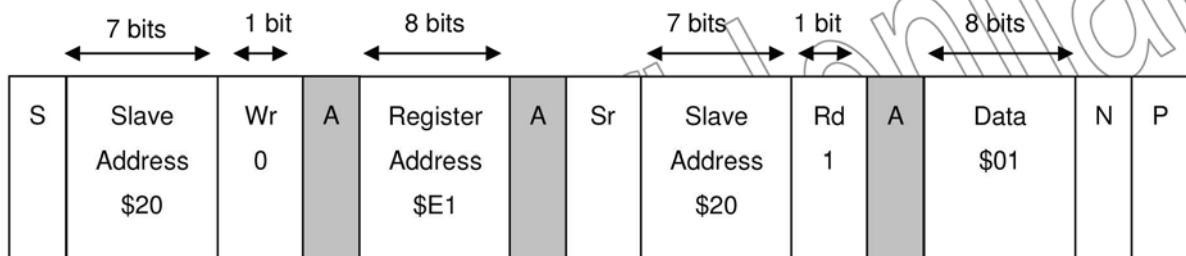

Figure A. Read Manufacturer ID command

Table A.

Symbol	Meaning
S	I2C bus Start condition. This is a falling edge on SDA while SCL is high.
Sr	Repeated Start condition. Same as S. Note that hosts that cannot generate Repeated Starts may use a Stop condition (P) followed by a another Start (S) instead.
P	I2C Stop condition. This is a rising edge on SDA while SCL is high.
A	I2C acknowledge (ACK). The data receiver pulls SDA low during a high pulse on SCL driven by the transmitter.
N	I2C not acknowledge (NACK). The data receiver lets SDA remain high during a high pulse on SCL driven by the transmitter.
Wr	'Write' bit. This has a value of 0.
Rd	'Read' bit. This has a value of 1.

Using register :

A. Page Select

Addr	Name	Bit7	Bit6	Bit5	Bit4	Bit3	Bit2	Bit1	Bit0	Access
0x00FF	Page Select	Page								W
Description		Set Page 0=0x00								

B. Communicating :

Address=0x0006 is used to read coordinate. It must continue to read 10 fingers data every time

Page 0x00 Registers

Addr	Name	Bit7	Bit6	Bit5	Bit4	Bit3	Bit2	Bit1	Bit0	Access
0x0006	F12_2D_DATA01(00)/00 Object Type and Status 0	Object Type and Status								RW
	F12_2D_DATA01(00)/01 Object Data 0	X LSB								RW
	F12_2D_DATA01(00)/02 Object Data 0	X MSB								RW
	F12_2D_DATA01(00)/03 Object Data 0	Y LSB								RW
	F12_2D_DATA01(00)/04 Object Data 0	Y MSB								RW
	F12_2D_DATA01(00)/05 Object Data 0	Z								RW
	F12_2D_DATA01(00)/06 Object Data 0	Wx								RW
	F12_2D_DATA01(00)/07 Object Data 0	Wy								RW
Description	<p>Object Type and Status (F12_2D_Data1(N)/0)</p> <ul style="list-style-type: none"> ○ 0x00 = No object ○ 0x01 = Finger ○ 0x02 = Stylus ○ 0x03 = Palm ○ 0x04 = Unclassified ○ 0x05 = Reserved ○ 0x06 = Gloved Finger <p>X and Y position data (MSB) These registers report the most-significant bits of the absolute X and Y position data.</p> <p>X and Y position data (LSB) This register contains the least-significant bits for both the X and Y absolute position information.</p> <p>Z This field reports the amount of finger contact or finger signal strength, which often serves as a</p>									

rough estimate of finger pressure. When $Z = 0$, the position cannot be measured and the X and Y Position registers are left unchanged. By default Z is taken as 0 whenever the device's built-in algorithms determine that no finger is present.

Wx, Wy

These fields report the estimated finger width as an unsigned integer, where 0 represents an extremely narrow finger and 15 represents an extremely wide contact such as a palm laid flat on the sensor. The ratio of Wx and Wy provides an estimate of the finger contact aspect ratio.

Display Timing:

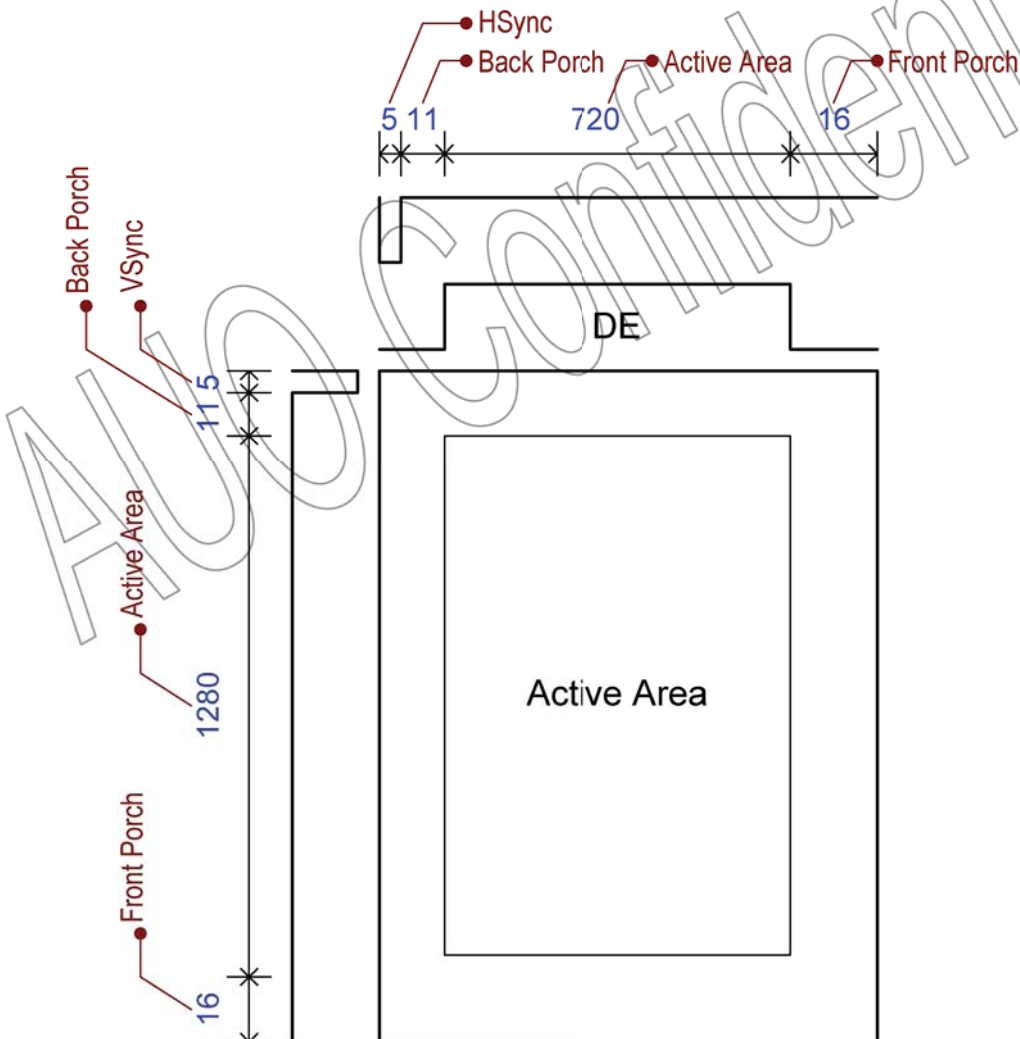

3 Specifications

Item	Abbr.	Min.	Typ.	Max.	Unit	Remark	
Optical Characteristic LCM (w/ Cover Lens)	Brightness	225	250	275	nits	Note 3	
	Wx	0.28	0.30	0.32			
	Wy	0.29	0.31	0.33			
Contrast ratio	@25deg	10000	--	--		Note 5	
Viewing angle CR>1600	Top	80°	--	--	deg	Note 7	
	Bottom	80°	--	--	deg		
	Left	80°	--	--	deg		
	Right	80°	--	--	deg		
Brightness Uniformity	250nits	70%	--	--		Note 6	
Optical Switching Time	+25°B/W(Tr+Tf)/2	--	--	1	ms	Note 4	
Color	Red	CIE1931 x	0.645	0.675	0.705	Red	Note 8
	Red	CIE1931 y	0.295	0.325	0.355	Red	
	Green	CIE1931 x	0.186	0.236	0.286	Green	
	Green	CIE1931 y	0.661	0.711	0.761	Green	
	Blue	CIE1931 x	0.090	0.130	0.170	Blue	
	Blue	CIE1931 y	0.025	0.065	0.105	Blue	
NTSC	CIE x , y	80	100	--	%		
Angular White Color Shifting	$\theta=30^\circ$ CIE x	-0.05	--	0.015			
	$\theta=30^\circ$ CIE y	-0.05	--	0.03			
	$\theta=60^\circ$ CIE x	-0.08	--	0.035			
	$\theta=60^\circ$ CIE y	-0.07	--	0.04			
Life time	T95	25C°	100	--	hrs	Note 10	
Flicker			--	--	-30	db	Note 9
Crosstalk	250nits	Vertical	--	--	5.0	%	Note 11
Gamma	γ	2.0	2.2	2.4			

Note 1: Ambient temperature = $25^{\circ}\text{C} \pm 2^{\circ}\text{C}$.

Note 2: To be measured in the dark room.

Note 3: The brightness measurement shall be done at the center of the display with a full white image. The brightness shall meet the following spec, at 100% check.

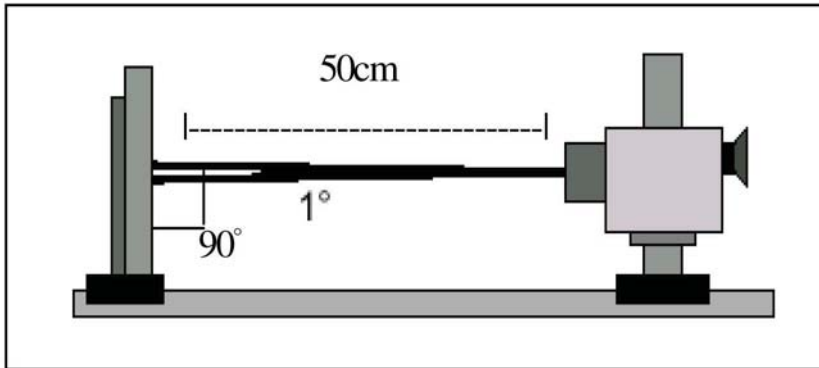

Note 4: Optical Switching Time:

The optical switching time measurements should be performed at driven BLACK and driven WHITE at typ. brightness setting by the driving techniques specified. The luminance should be measured with the emitting display and the detector at $\theta=0^{\circ}$ and $\psi=90^{\circ}$. The rise time t_r is the time between a 10% optically response of the display and a 90% optically response of the display. The fall time t_f is the time between a 10% optically response of the display and a 90% optically response to the display. The response time is defined as the average of the rise time and the fall time.

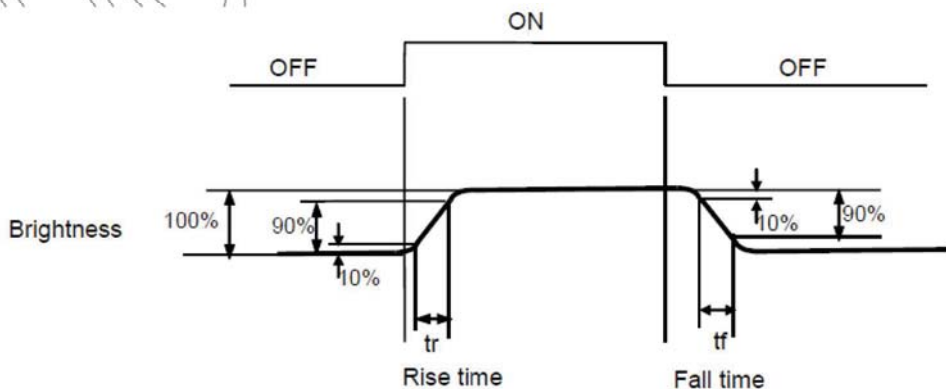

Note 5: Definition of contrast ratio:

Contrast ratio is calculated with the following formula:

$$\text{Contrast ratio (CR)} = \frac{\text{Photo detector output when OLED is at "White"}}{\text{Photo detector output when OLED is at "Black"}}$$

Note 6: Uniformity. Refer to figure as below

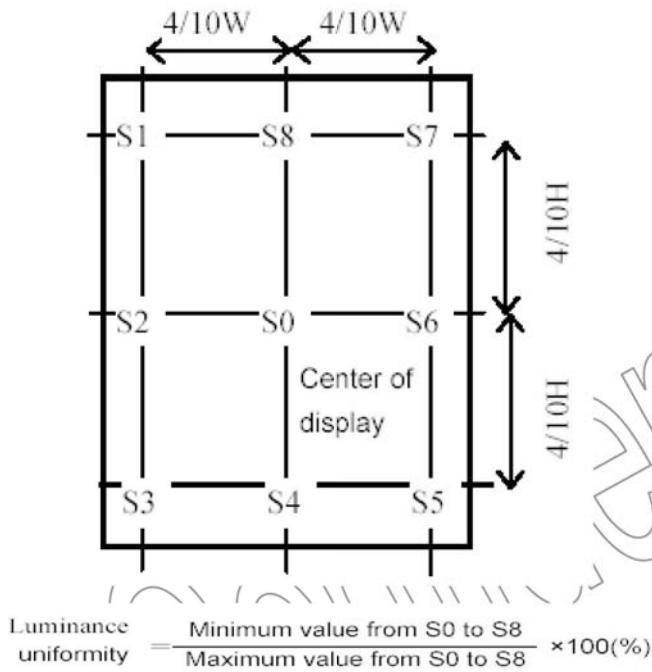

Note 7: Definition of viewing angle :

The optical performance is specified as the driver IC located at $\theta = 270^\circ$

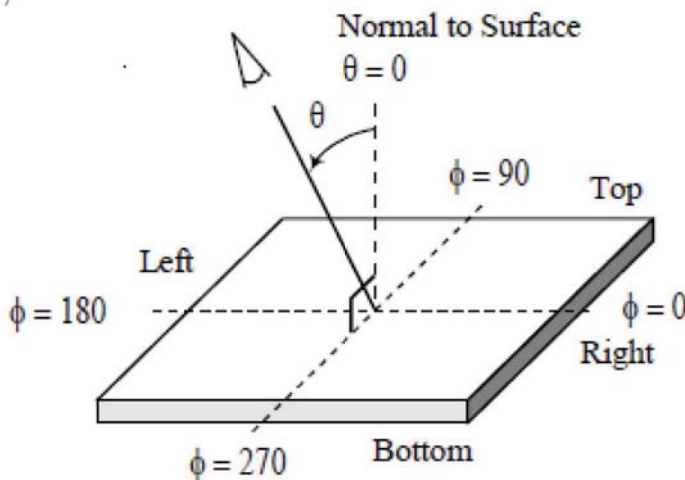

Note 8: The color chromaticity should be based on sample performance because new OLED material should be verified later.

Note 9: Flicker

The flicker level is defined using Fast Fourier Transformation (FTT) as follows:

$$Flicker = 20 \log_{10} \left(2 \frac{f_{FFTC}(n)}{f_{FFTC}(0)} \right) + FS(Hz) \quad (dB)$$

where $f_{FFTC}(n)$ is the n th FFT coefficient, and $f_{FFTC}(0)$ is the 0th FFT coefficient which is DC component. $FS(Hz)$ is the flicker sensitivity as a function of frequency.

The flicker level shall be measured with the test pattern in below.

The gray levels of test pattern is 128.

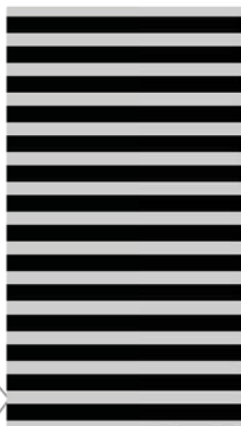

Note 10: Time to 95% Luminance

To measure the burn-in effect, a test pattern with white background applied to the AMOLED display at 30% loading

Note 11: Cross-talk

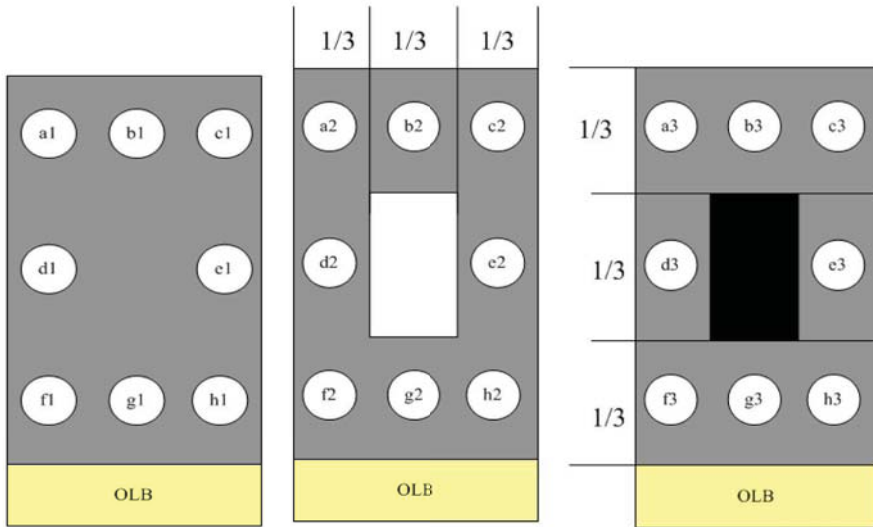

$$CrossTalk_White = \left\{ \begin{array}{l} 1 - \left(\frac{b2}{a2} + \frac{b1}{a1} \right) \times 100\%, 1 - \left(\frac{b2}{c2} + \frac{b1}{c1} \right) \times 100\%, \\ 1 - \left(\frac{d2}{a2} + \frac{d1}{a1} \right) \times 100\%, 1 - \left(\frac{d2}{f2} + \frac{d1}{f1} \right) \times 100\%, \\ 1 - \left(\frac{e2}{c2} + \frac{e1}{c1} \right) \times 100\%, 1 - \left(\frac{e2}{h2} + \frac{e1}{h1} \right) \times 100\%, \\ 1 - \left(\frac{g2}{f2} + \frac{g1}{f1} \right) \times 100\%, 1 - \left(\frac{g2}{h2} + \frac{g1}{h1} \right) \times 100\% \end{array} \right\}$$

$$CrossTalk_Black = \left\{ \begin{array}{l} 1 - \left(\frac{b3}{a3} + \frac{b1}{a1} \right) \times 100\%, 1 - \left(\frac{b3}{c3} + \frac{b1}{c1} \right) \times 100\%, \\ 1 - \left(\frac{d3}{a3} + \frac{d1}{a1} \right) \times 100\%, 1 - \left(\frac{d3}{f3} + \frac{d1}{f1} \right) \times 100\%, \\ 1 - \left(\frac{e3}{c3} + \frac{e1}{c1} \right) \times 100\%, 1 - \left(\frac{e3}{h3} + \frac{e1}{h1} \right) \times 100\%, \\ 1 - \left(\frac{g3}{f3} + \frac{g1}{f1} \right) \times 100\%, 1 - \left(\frac{g3}{h3} + \frac{g1}{h1} \right) \times 100\% \end{array} \right\}$$

$$CrossTalk = MAX\{CrossTalk_White, CrossTalk_Black\}$$

G. Reliability Test Items

Category	No.	Test items	Conditions	Remark
Reliability (Environment)	1	High Temp. Operation	Ta= 60°C 168hrs	Ta: Ambient temperature.
	2	High Temp. Storage	Ta= 70°C 168hrs	Non-operation
	3	Low Temp. Operation	Ta= -20°C 168hrs	
	4	Low Temp. Storage	Ta= -30°C 168hrs	Non-operation
	5	High Temp./Humi. Operation	Ta= 40°C. 95% RH 168hrs	
	6	Thermal Shock	-30°C~70°C, Dwell for 30 min. 30 cycles.	Non-operation
	7	Low Pressure Storage	Condition: 40,000 ft, room temperature, 48hrs. Criterion: Normal performance after recovery time.	Non-operation
Reliability (Mechanical)	8	Shock Test	Half Sine, 400G, duration time 2 ms, One shock for each surfaces, total 6/shocks	Non-operation
	9	Random Vibration Test	0.025G2/Hz, 10~500Hz Nominal 3.5Grms in each axis, 30 minutes each axis	Non-operation
	10	Sinusoidal Vibration Test	0.5 octave / minutes sweep rate One sweep, 10 to 500Hz, all 3 axes (X, Y, Z) Fixture used: Fasten the specimen to the vibration table Power is OFF	Non-operation
	11	FPC Bending	Connector side: Bending FPC with 180° both clockwise and counterclockwise OLED side: Bending FPC with 180° both clockwise and counterclockwise minimum 30 cycles for every side.	Non-operation
	12	FPC connection insert/ Remove	Insert/Remove LCM FPC for 15 cycles.	
ESD	13	IEC 61000-4-2	There is no degradation of OLED performance after this test. (LCM level)	
		Air Discharge ±8KV Contact Discharge ±4KV		
	14	IEC 61000-4-2 Air Discharge ±15KV Contact Discharge ±8KV	There is no OLED damage after this test. (System level)	
Grounding	15	Metal frame grounding	The resistance between FPC ground pin and metal frame should be less than 1 Ohm before/after all reliability test	

H. Packing

紙箱尺寸:546mm x 406mm x 278mm

棧板尺寸:1150mmx840mmx132mm

1set for 20 tray (8pcs) +1 tray(空) =160pcs module

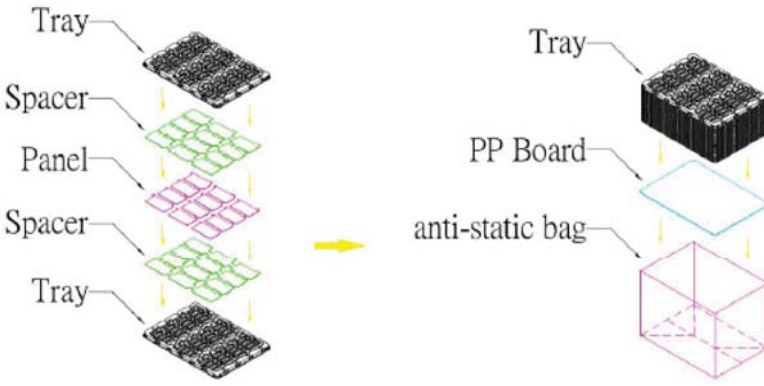

(1tray 8 OLED, 2 spacer)

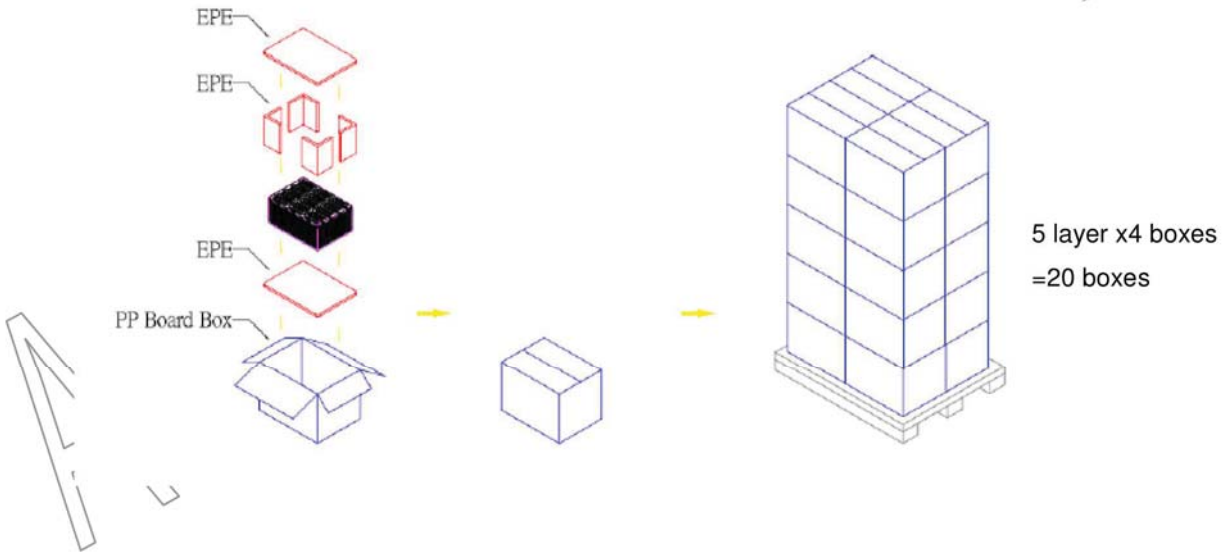

5 layer x4 boxes =20 boxes

I. Outline Dimension (Tentative)

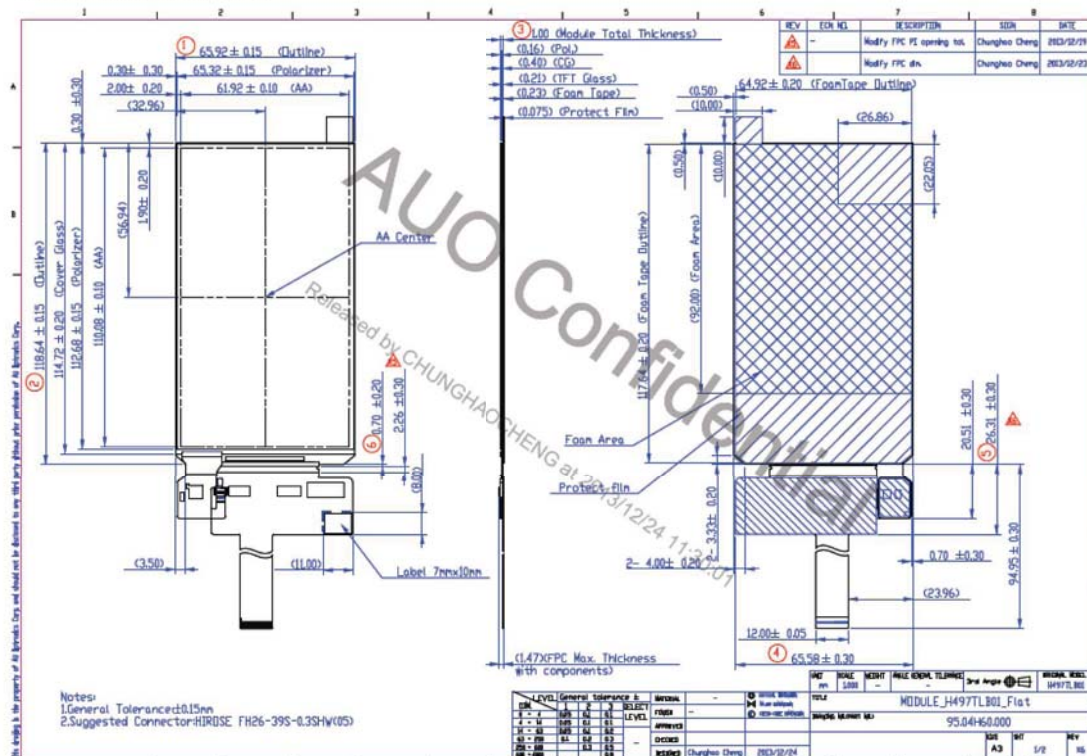

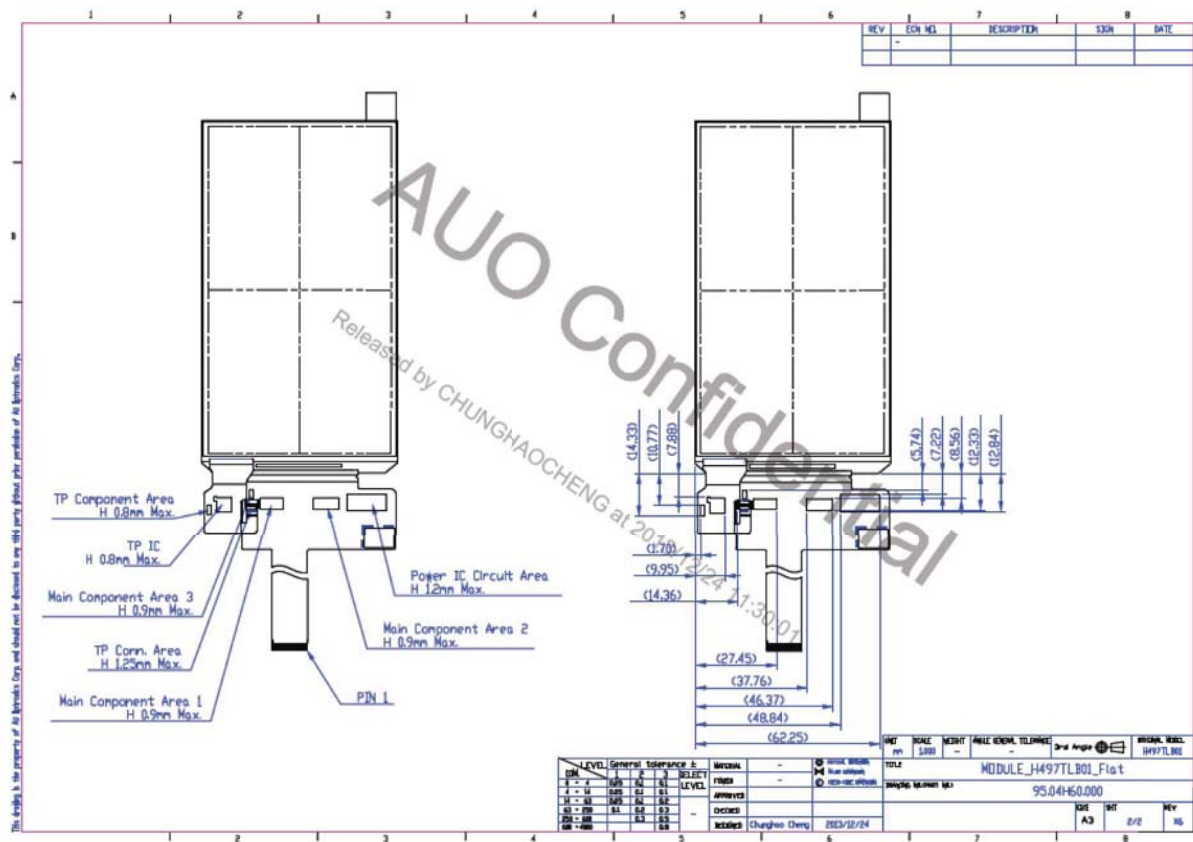

This drawing is the property of All Rights Reserved Co., and should not be disclosed to any third party without prior permission of All Rights Reserved Co.,

AUO Confidential

Released by CHUNGHAOCHENG at 2013/12/24 17:50:07

REV	CHG NOL	DESCRIPTION	SKW	DATE
-				

LEVEL	General	Intolerance & SELECT	Material	REMARK	TITLE	DATE	SCALE	HEIGHT	FRAME GENERAL TOLERANCE	3rd Angle	SYMBOL	SYMBOL
1	1	1	1	1	MODULE_H497TLB01_Flat	2013/12/24	1:1	3000				
2	2	2	2	2								
3	3	3	3	3								
4	4	4	4	4								
5	5	5	5	5								
6	6	6	6	6								
7	7	7	7	7								
8	8	8	8	8								
9	9	9	9	9								
10	10	10	10	10								
11	11	11	11	11								
12	12	12	12	12								
13	13	13	13	13								
14	14	14	14	14								
15	15	15	15	15								
16	16	16	16	16								