

## METAL SHELL RIGHT ANGLE FEMALE RECEPTACLES FOR PCB MOUNTING

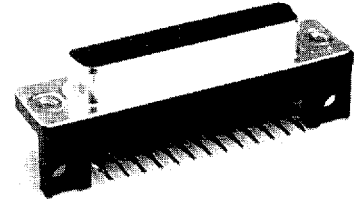

LR49571 E60980

### PHYSICAL PROPERTIES

**INSULATION MATERIAL:** Glass filled thermoplastic rated UL 94V-0

**COLOR:** Black

**CONTACTS:** High strength copper alloy

**METAL SHELL:** Steel, bright tin plate

**DURABILITY:** Up to 500 insertions and withdrawals without degradation of performance, dependent upon contact plating thickness selected

### ELECTRICAL PROPERTIES

**OPERATING VOLTAGE:** 600 VDC (sea level)

**CURRENT RATING:** 5 Amperes

**CONTACT RESISTANCE:** 10 milliohms max.

@ rated current

**INSULATION RESISTANCE:** 5000 megohms minimum

**DIELECTRIC WITHSTANDING VOLTAGE:**

1000 VAC minimum

### ENVIRONMENTAL PROPERTIES

**TEMPERATURE RATING:** -55°C TO 125°C

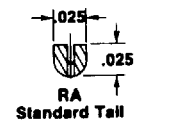
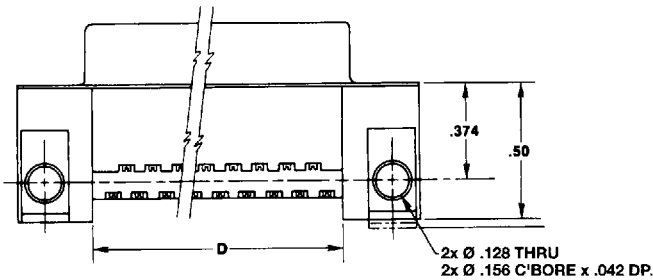
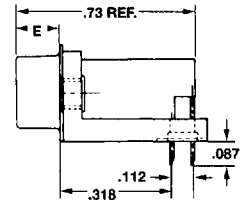
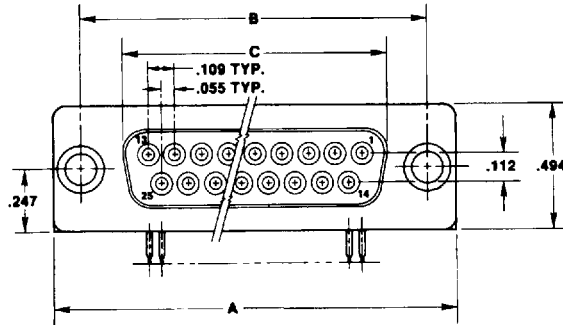

TAIL SECTION (X-X)

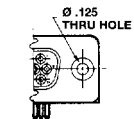
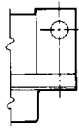

MOUNTING STYLE A  
FLUSH

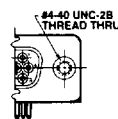
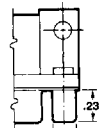

MOUNTING STYLE B  
THREADED STANDOFF

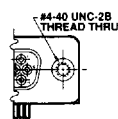
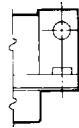

MOUNTING STYLE C  
FLUSH INSERT

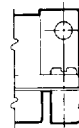

MOUNTING STYLE J  
THREADED CABLE LATCH

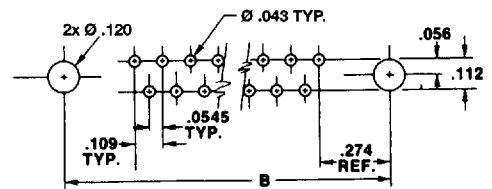

PC BOARD HOLE PATTERN

### Ordering Information

NUMBER OF CONTACTS	BASIC CONNECTOR W/THRU HOLES	CATALOG NUMBER BY MOUNTING STYLE				DIMENSIONS			
		ROUND STANDOFF 4-40 THREAD	FLUSH INSERT 4-40 THREAD	LATCH W/STANDOFF & 4-40 THREADED INSERT	A	B	C	D	
9	H5R09RA29A	H5R09RA29B	H5R09RA29C	H5R09RA29J	1.224	.984	.646	.624	
15	H5R15RA29A	H5R15RA29B	H5R15RA29C	H5R15RA29J	1.552	1.312	.974	.952	
25	H5R25RA29A	H5R25RA29B	H5R25RA29C	H5R25RA29J	2.092	1.852	1.514	1.492	
37	H5R37RA29A	H5R37RA29B	H5R37RA29C	H5R37RA29J	2.740	2.500	2.162	2.140	

www.DataSheet4U.com

Add suffix S for metal snap latches and P for plastic. See page 316 for descriptions. Not available on basic connector.