

**OBSOLETE PRODUCT
NO RECOMMENDED REPLACEMENT**
contact our Technical Support Center at
1-888-INTERSIL or www.intersil.com/tsc

80MHz, High Slew Rate, High Output Current, Video Operational Amplifier

The HA-2842 is a wideband, high slew rate, operational amplifier featuring an outstanding combination of speed, bandwidth, and output drive capability. This amplifier's performance is further enhanced through stable operation down to closed loop gains of +2, the inclusion of offset null controls, and by its excellent video performance.

The capabilities of the HA-2842 are ideally suited for high speed cable driver circuits, where low closed loop gains and high output drive are required. With a 6MHz full power bandwidth, this amplifier is well suited for high frequency signal conditioning circuits and video amplifiers. Gain flatness of 0.035dB, combined with differential gain and phase specifications of 0.02%, and 0.03 degrees, respectively, make the HA-2842 ideal for component and composite video applications.

A zener/nichrome based reference circuit, coupled with advanced laser trimming techniques, yields a supply current with a low temperature coefficient and low lot-to-lot variability. For example, the average I_{CC} variation from 85°C to -40°C is <600µA (±2%), while the standard deviation of the I_{CC} distribution is <0.1mA (0.8%) at 25°C. Tighter I_{CC} control translates to more consistent AC parameters ensuring that units from each lot perform the same way, and easing the task of designing systems for wide temperature ranges. Critical AC parameters, Slew Rate and Bandwidth, each vary by less than ±5% over the industrial temperature range (see Typical Performance Curves)

Part Number Information.

PART NUMBER (BRAND)	TEMP. RANGE (°C)	PACKAGE	PKG. DWG. #
HA9P2842-5 (H2842F5)	0 to 75	8 Ld SOIC	M8.15

Features

- Stable at Gains of 2 or Greater
- Low AC Variability Over Process and Temperature
- Gain Bandwidth 80MHz
- Gain Flatness to 10MHz. 0.035dB
- High Slew Rate. 400V/µs
- High Output Current (Min) 100mA
- Differential Gain/Phase 0.02%/0.03 Degrees
- Low Supply Current (Max) 15mA
- Enhanced Replacement for AD842

Applications

- Pulse and Video Amplifiers
- Wideband Amplifiers
- Coaxial Cable Drivers
- Fast Sample-Hold Circuits
- High Frequency Signal Conditioning Circuits

Pinout

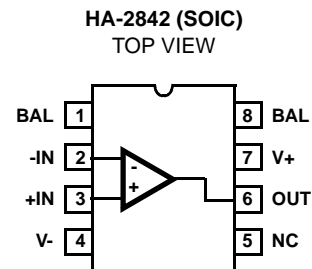

Absolute Maximum Ratings

Voltage Between V+ and V- Terminals 35V
 Differential Input Voltage 6V
 Output Current (Notes 3, 4) 125mA
 100mA (50% Duty Cycle)

Operating Conditions

Temperature Range
 HA-2842-5 0°C to 75°C
 Recommended Supply Voltage Range ±6.5V to ±15V

Thermal Information

Thermal Resistance (Typical, Note 2) θ_{JA} (°C/W)
 8 Lead SOIC Package 160
 Maximum Junction Temperature (Die) 175°C
 Maximum Junction Temperature (Plastic Package, Note 1) 150°C
 Maximum Storage Temperature Range -65°C to 150°C
 Maximum Lead Temperature (Soldering 10s) 300°C
 (Lead Tips Only)

CAUTION: Stresses above those listed in "Absolute Maximum Ratings" may cause permanent damage to the device. This is a stress only rating and operation of the device at these or any other conditions above those indicated in the operational sections of this specification is not implied.

NOTES:

1. Maximum power dissipation, including output load, must be designed to maintain the maximum junction temperature below 150°C for plastic packages. By using Application Note AN556 on Safe Operating Area equations, along with the packaging thermal resistances listed in the Thermal Information section, proper load conditions can be determined.
2. θ_{JA} is measured with the component mounted on an evaluation PC board in free air.
3. $V_O = \pm 5V$, R_L Unconnected, Duty cycle $\leq 50\%$. For information about using high output current amplifiers, please refer to Application Note AN556 (Thermal Safe-Operating-Areas For High Current Op Amps), and the "Power Dissipation Considerations" section in the "Application Information" section of this datasheet.
4. Maximum continuous (100% Duty Cycle) output current is 50mA. For currents >50mA, Duty Cycle must be derated accordingly.

Electrical Specifications $V_{SUPPLY} = \pm 15V$, $R_L = 1k\Omega$, $C_L \leq 10pF$, Unless Otherwise Specified

PARAMETER	TEST CONDITIONS	TEMP (°C)	HA-2842-5			UNITS
			MIN	TYP	MAX	
INPUT CHARACTERISTICS						
Offset Voltage (Note 10)		25	-	1	3	mV
		Full	-	-	6	mV
Average Offset Voltage Drift		Full	-	13	-	$\mu V/^\circ C$
Bias Current (Note 10)		25	-	5	10	μA
		Full	-	-	15	μA
Average Bias Current Drift		Full	-	20	-	$nA/^\circ C$
Offset Current		25	-	0.5	1.0	μA
		Full	-	-	1.5	μA
Average Offset Current Drift		Full	-	1.3	-	$nA/^\circ C$
Input Resistance		25	-	170	-	$k\Omega$
Input Capacitance		25	-	1	-	pF
Common Mode Range		Full	±10	-	-	V
Input Noise Voltage	10Hz to 1MHz	25	-	16	-	μV_{RMS}
Input Noise Voltage Density	$f = 1kHz$, $R_{SOURCE} = 0\Omega$	25	-	16	-	nV/\sqrt{Hz}
Input Noise Current (Note 10)	$f = 1kHz$, $R_{SOURCE} = 100k\Omega$	25	-	2	-	pA/\sqrt{Hz}
TRANSFER CHARACTERISTICS						
Large Signal Voltage Gain	$V_O = \pm 10V$	25	50	100	-	kV/V
		Full	30	60	-	kV/V
Common-Mode Rejection Ratio (Note 10)	$V_{CM} = \pm 10V$	Full	80	110	-	dB
Minimum Stable Gain		25	2	-	-	V/V
Gain Bandwidth Product (Note 10)	$A_{VCL} = 100$	25	-	80	-	MHz
Gain Flatness to 10MHz (Note 10)	$R_L \geq 75\Omega$	25	-	±0.035	-	dB

HA-2842

Electrical Specifications $V_{SUPPLY} = \pm 15V$, $R_L = 1k\Omega$, $C_L \leq 10pF$, Unless Otherwise Specified (Continued)

PARAMETER	TEST CONDITIONS	TEMP (°C)	HA-2842-5			UNITS
			MIN	TYP	MAX	
OUTPUT CHARACTERISTICS						
Output Voltage Swing (Note, 10)	$V_O = \pm 10V$	Full	± 10	± 11	-	V
Output Current (Note 10)	(Note 3)	Full	100	-	-	mA
Output Resistance		25	-	8.5	-	Ω
Full Power Bandwidth (Note 6)	$V_O = \pm 10V$	25	5.2	6	-	MHz
Differential Gain (Note 10)	(Note 5)	25	-	0.02	-	%
Differential Phase (Note 10)	(Note 5)	25	-	0.03	-	Degrees
Harmonic Distortion (Note 10)	$V_O = 2V_{P-P}$, $f = 1MHz$, $A_V = 2$	25	-	>81	-	dBc
TRANSIENT RESPONSE (Note 7)						
Rise Time		25	-	4	-	ns
Overshoot		25	-	25	-	%
Slew Rate (Notes 9, 10)	$A_V = +2$	25	325	400	-	V/ μs
Settling Time	10V Step to 0.1%	25	-	100	-	ns
POWER REQUIREMENTS						
Supply Current (Note 10)		25	-	14.2	-	mA
		Full	-	14.3	15	mA
Power Supply Rejection Ratio (Note 10)	(Note 8)	Full	70	80	-	dB

NOTES:

5. Differential gain and phase are measured with a VM700A video tester, using a NTC-7 composite VITS. $R_F = R_1 = 1k\Omega$, $R_L = 700\Omega$.
6. Full Power Bandwidth guaranteed based on slew rate measurement using $FPBW = \frac{Slew\ Rate}{2\pi V_{PEAK}}$; $V_{PEAK} = 10V$.
7. Refer to Test Circuits section of this data sheet.
8. $V_{SUPPLY} = \pm 10V$ to $\pm 20V$.
9. This parameter is not tested. The limits are guaranteed based on lab characterization and reflect lot-to-lot variation.
10. See "Typical Performance Curves" for more information.

Test Circuits and Waveforms

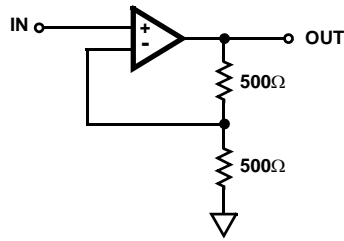

- NOTES:
11. $V_S = \pm 15V$.
 12. $A_V = +2$.
 13. $C_L \leq 10pF$

TEST CIRCUIT

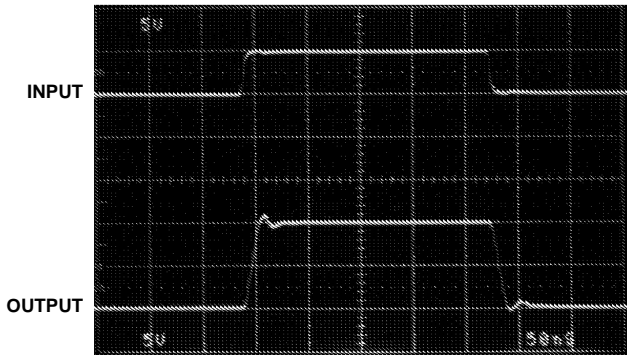

Input = 5V/Div., Output = 5V/Div., 50ns/Div.

LARGE SIGNAL RESPONSE

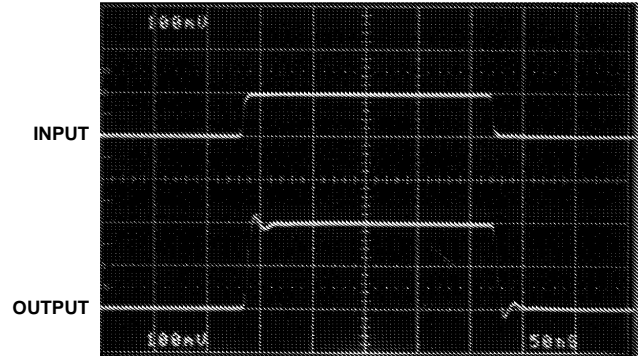

Input = 100mV/Div., Output = 100mV/Div., 50ns/Div.

SMALL SIGNAL RESPONSE

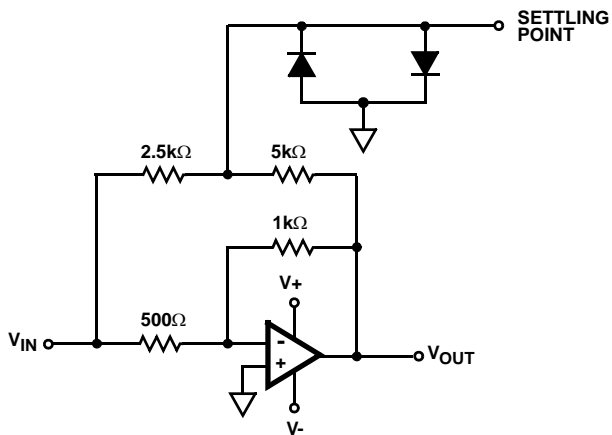

SETTLING TIME TEST CIRCUIT

- NOTES:
14. $A_V = -2$.
 15. Feedback and summing resistors must be matched (0.1%).
 16. HP5082-2810 clipping diodes recommended.
 17. Tektronix P6201 FET probe used at settling point.
 18. For 0.01% settling time, heat sinking is suggested to reduce thermal effects and an analog ground plane with supply decoupling is suggested to minimize ground loop errors.

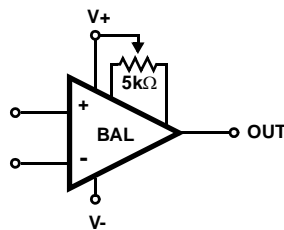

SUGGESTED OFFSET VOLTAGE ADJUSTMENT

Application Information

The Intersil HA-2842 is a state of the art monolithic device which also approaches the “ALL-IN-ONE” amplifier concept. This device features an outstanding set of AC parameters augmented by excellent output drive capability providing for suitable application in both high speed and high output drive circuits.

Primarily intended to be used in balanced 50Ω and 75Ω coaxial cable systems as a driver, the HA-2842 could also be used as a power booster in audio systems as well as a power amp in power supply circuits. This device would also be suitable as a small DC motor driver.

Prototyping Guidelines

For best overall performance in any application, it is recommended that high frequency layout techniques be used. This should include:

1. Mounting the device through a ground plane.
2. Connecting unused pins (NC) to the ground plane.
3. Mounting feedback components on Teflon standoffs and/or locating these components as close to the device as possible.
4. Placing power supply decoupling capacitors from device supply pins to ground.

Power Dissipation Considerations

At high output currents, especially with the 8 lead SOIC package, care must be taken to ensure that the Maximum Junction Temperature (T_J , see “Absolute Maximum Ratings” table) isn’t exceeded. As an example consider the HA-2842 in the SOIC package, with a required output current of 50mA at $V_{OUT} = 10V$ with $\pm 15V$ supplies. The power dissipation is the quiescent power ($450mW = 30V \times 15mA$) plus the power dissipated in the output stage ($P_{OUT} = 250mW = 50mA \times (15V - 10V)$), or a total of 700mW. The thermal resistance (θ_{JA}) of the SOIC package is $157^\circ C/W$, which increases the junction temperature by $110^\circ C$ over the ambient temperature (T_A). Remaining below T_{JMAX} requires that T_A be restricted to $\leq 40^\circ C$ ($150^\circ C - 110^\circ C$). Heatsinking would be required for operation at ambient temperatures greater than $40^\circ C$.

MAX P_{OUT} WITHOUT HEATSINK ($V_S = \pm 15V$)

T_A	8 LEAD SOIC ($\theta_{JA} = 157^\circ C/W$)
$85^\circ C$	Heatsink Required
$70^\circ C$	60mW
$25^\circ C$	350mW

Allowable output power can be increased by decreasing the quiescent dissipation via lower supply voltages.

For more information please refer to Application Note AN556, Thermal Safe Operating Areas for High Current Op Amps.

Typical Performance Curves $T_A = 25^\circ C$, $V_{SUPPLY} = \pm 15V$, $R_L = 1k\Omega$, $C_L < 10pF$, Unless Otherwise Specified

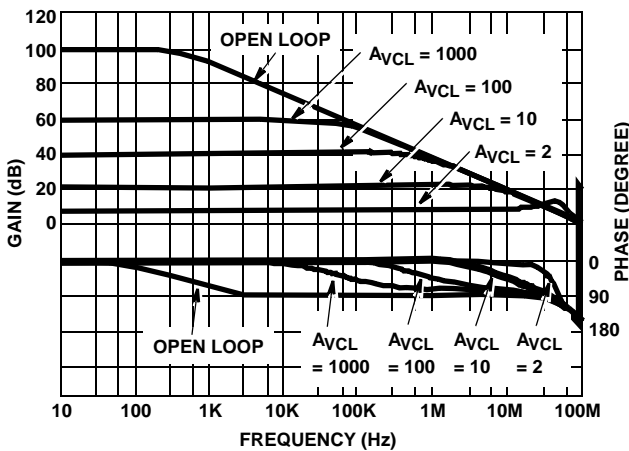

FIGURE 1. FREQUENCY RESPONSE FOR VARIOUS GAINS

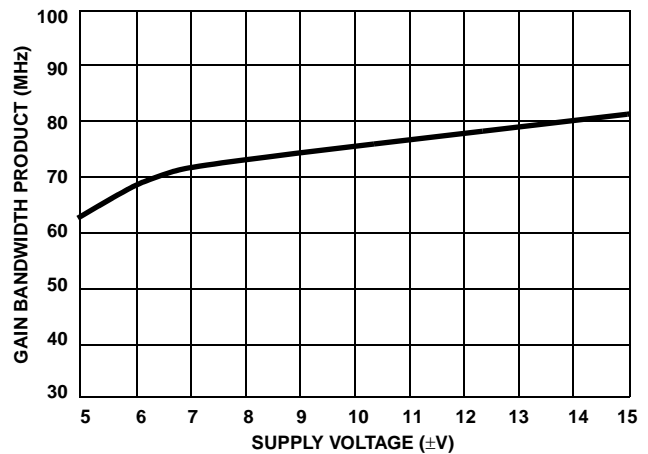

FIGURE 2. GAIN BANDWIDTH PRODUCT vs SUPPLY VOLTAGE

Typical Performance Curves $T_A = 25^\circ\text{C}$, $V_{\text{SUPPLY}} = \pm 15\text{V}$, $R_L = 1\text{k}\Omega$, $C_L < 10\text{pF}$, Unless Otherwise Specified (Continued)

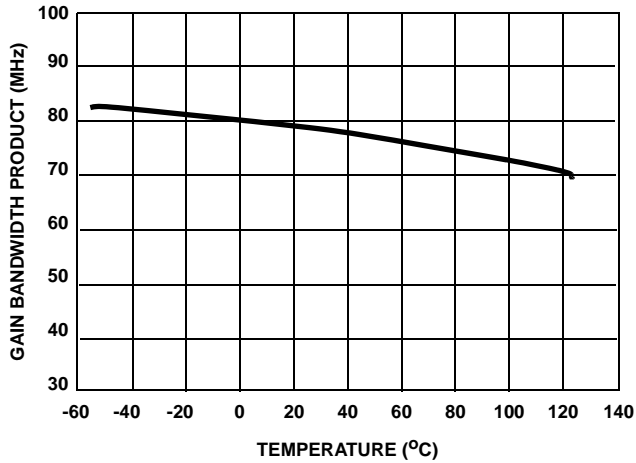

FIGURE 3. GAIN BANDWIDTH PRODUCT vs TEMPERATURE

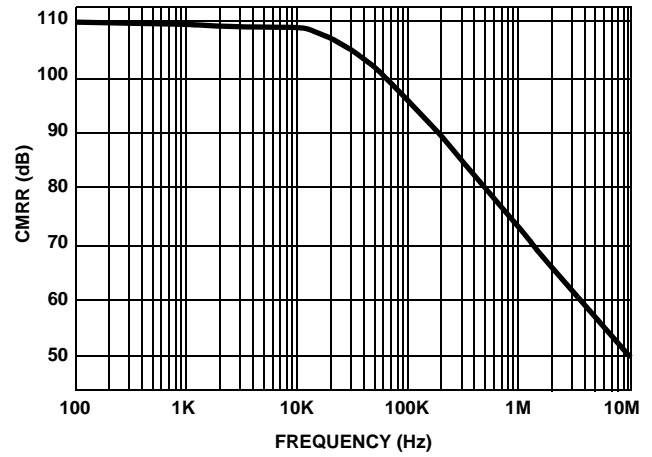

FIGURE 4. CMRR vs FREQUENCY

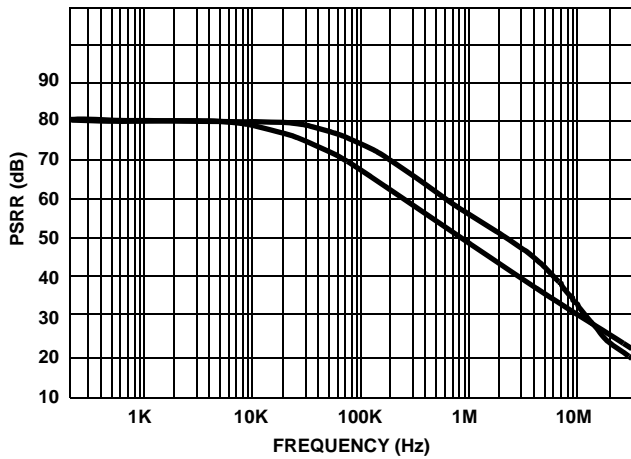

FIGURE 5. PSRR vs FREQUENCY

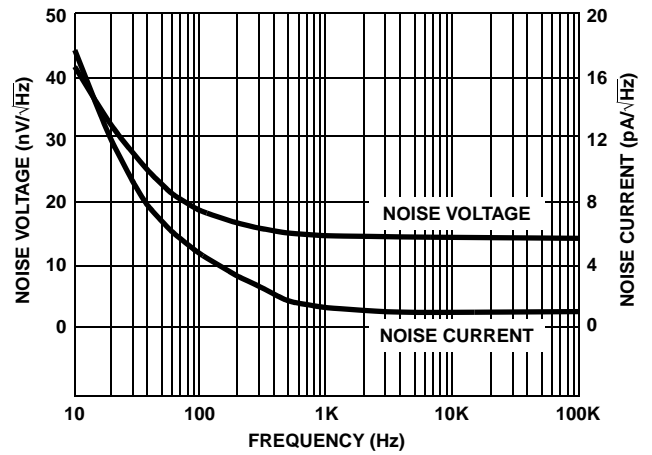

FIGURE 6. INPUT NOISE vs FREQUENCY

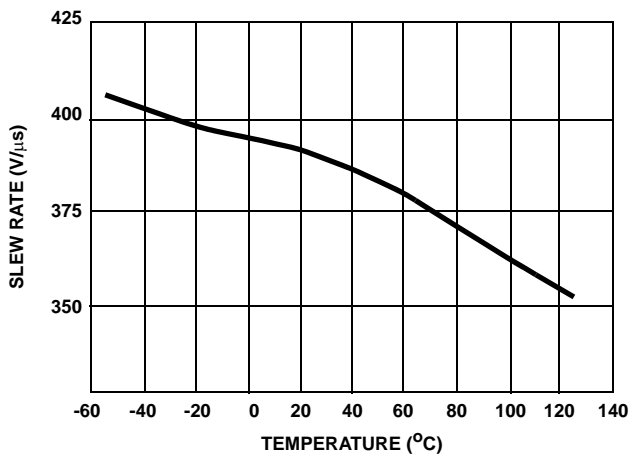

FIGURE 7. SLEW RATE vs TEMPERATURE

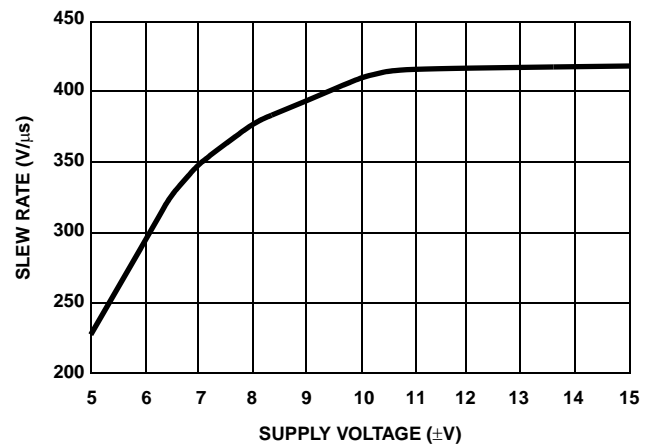

FIGURE 8. SLEW RATE vs SUPPLY VOLTAGE

Typical Performance Curves $T_A = 25^\circ\text{C}$, $V_{\text{SUPPLY}} = \pm 15\text{V}$, $R_L = 1\text{k}\Omega$, $C_L < 10\text{pF}$, Unless Otherwise Specified (Continued)

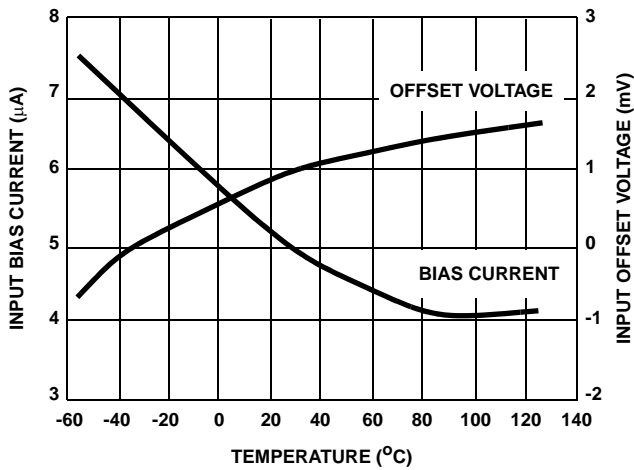

FIGURE 9. INPUT OFFSET VOLTAGE AND INPUT BIAS CURRENT vs TEMPERATURE

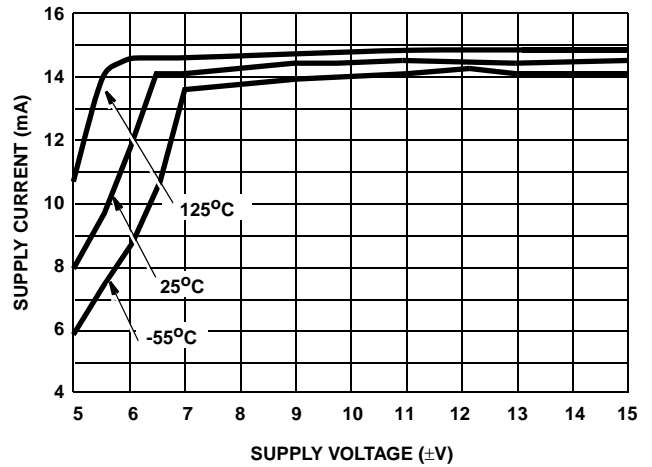

FIGURE 10. SUPPLY CURRENT vs SUPPLY VOLTAGE

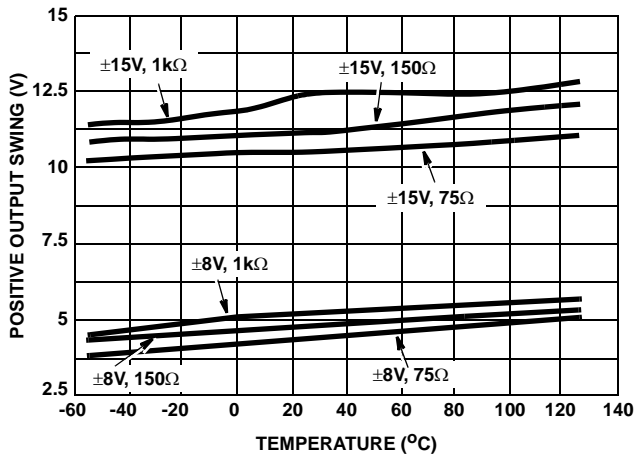

FIGURE 11. POSITIVE OUTPUT SWING vs TEMPERATURE

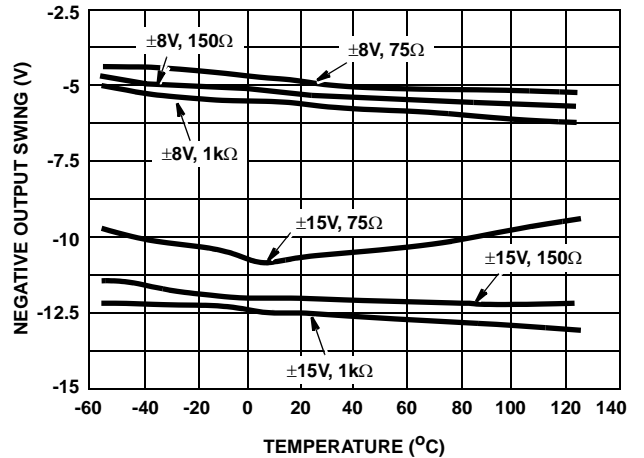

FIGURE 12. NEGATIVE OUTPUT SWING vs TEMPERATURE

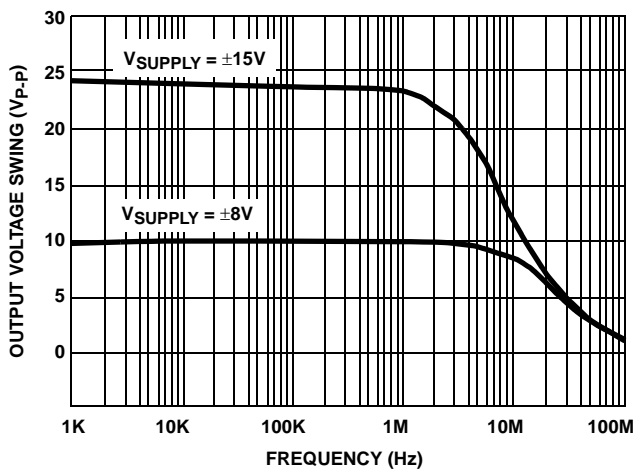

FIGURE 13. MAXIMUM UNDISTORTED OUTPUT SWING vs FREQUENCY

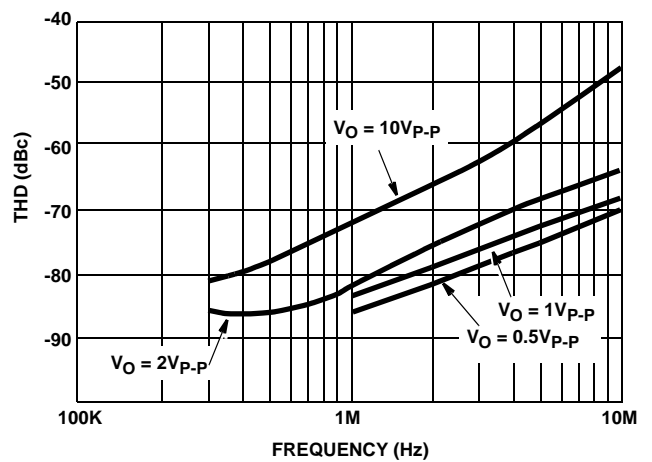

FIGURE 14. TOTAL HARMONIC DISTORTION vs FREQUENCY

Typical Performance Curves $T_A = 25^\circ\text{C}$, $V_{\text{SUPPLY}} = \pm 15\text{V}$, $R_L = 1\text{k}\Omega$, $C_L < 10\text{pF}$, Unless Otherwise Specified (Continued)

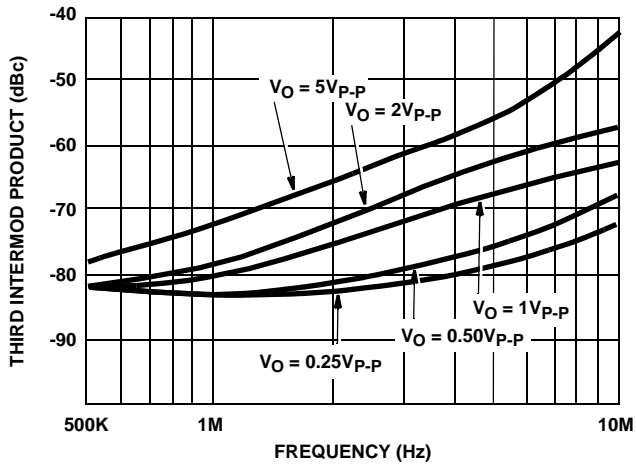

FIGURE 15. INTERMODULATION DISTORTION vs FREQUENCY (TWO TONE)

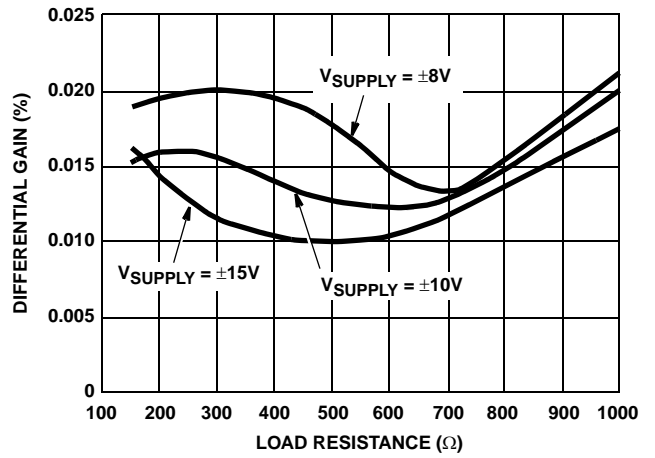

FIGURE 16. DIFFERENTIAL GAIN vs LOAD RESISTANCE

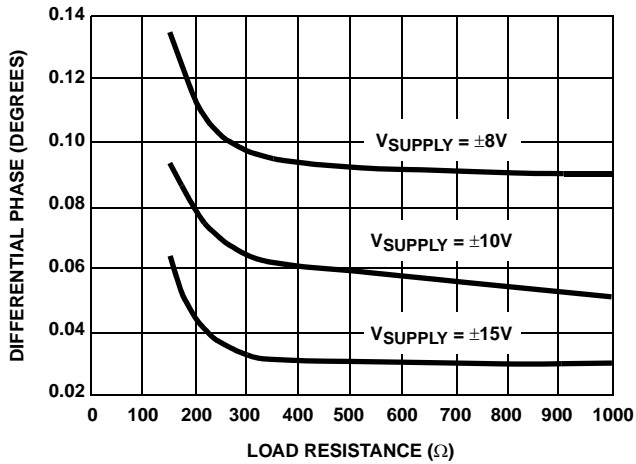

FIGURE 17. DIFFERENTIAL PHASE vs LOAD RESISTANCE

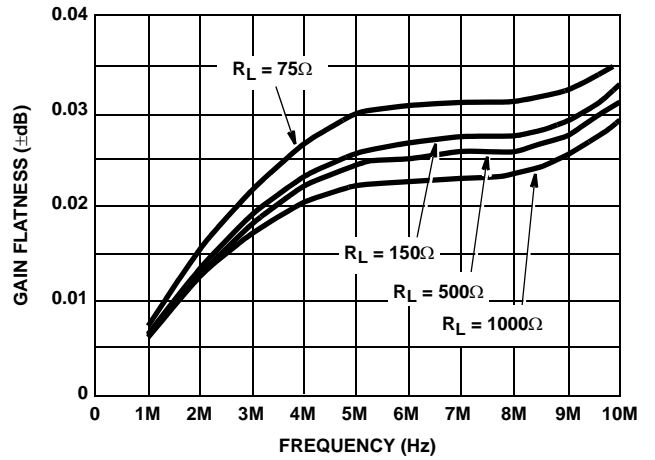

FIGURE 18. GAIN FLATNESS vs FREQUENCY ($A_{VCL} = 2$)

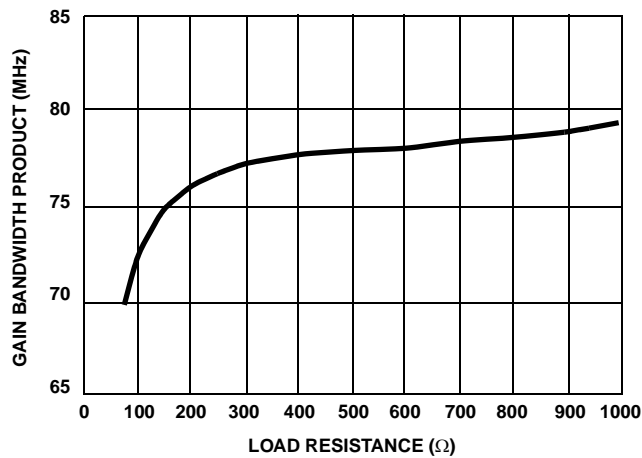

FIGURE 19. GAIN BANDWIDTH PRODUCT vs LOAD RESISTANCE

Die Characteristics

DIE DIMENSIONS:

77 mils x 81 mils x 19 mils
1960µm x 2060µm x 483µm

METALLIZATION:

Type: Aluminum, 1% Copper
Thickness: 16kÅ ±2kÅ

PASSIVATION:

Type: Nitride over Silox
Silox Thickness: 12kÅ ±2kÅ
Nitride thickness: 3.5kÅ ±1kÅ

SUBSTRATE POTENTIAL (POWERED UP):

V-

TRANSISTOR COUNT:

58

PROCESS:

High Frequency Bipolar Dielectric Isolation

Metallization Mask Layout

HA-2842

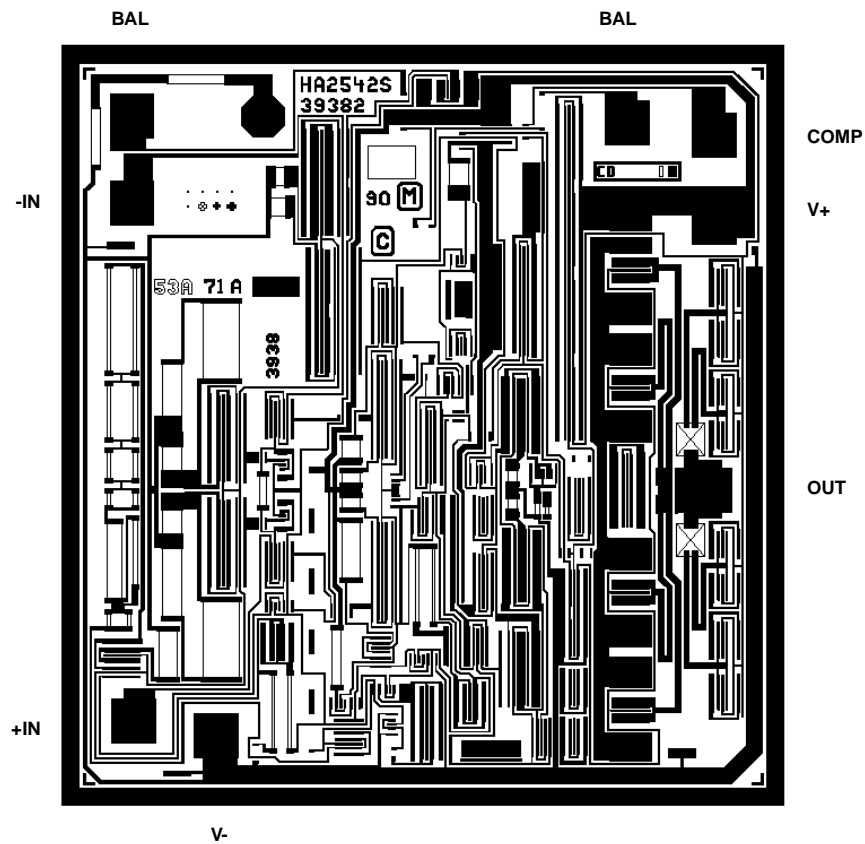

Small Outline Plastic Packages (SOIC)

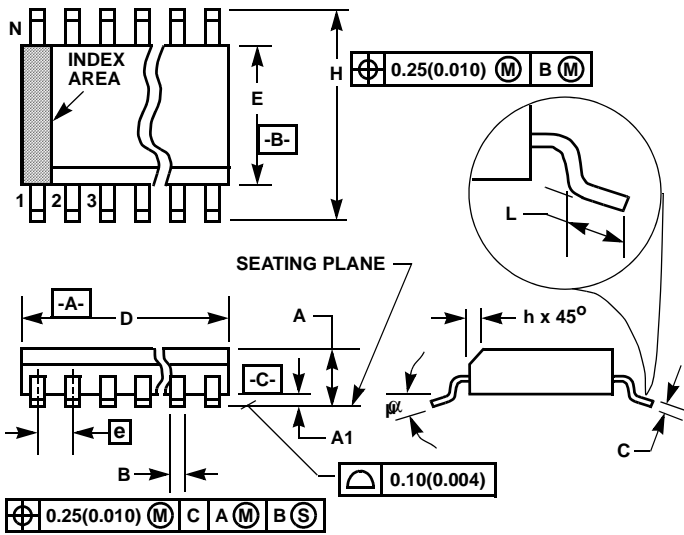

M8.15 (JEDEC MS-012-AA ISSUE C)
8 LEAD NARROW BODY SMALL OUTLINE PLASTIC PACKAGE

SYMBOL	INCHES		MILLIMETERS		NOTES
	MIN	MAX	MIN	MAX	
A	0.0532	0.0688	1.35	1.75	-
A1	0.0040	0.0098	0.10	0.25	-
B	0.013	0.020	0.33	0.51	9
C	0.0075	0.0098	0.19	0.25	-
D	0.1890	0.1968	4.80	5.00	3
E	0.1497	0.1574	3.80	4.00	4
e	0.050 BSC		1.27 BSC		-
H	0.2284	0.2440	5.80	6.20	-
h	0.0099	0.0196	0.25	0.50	5
L	0.016	0.050	0.40	1.27	6
N	8		8		7
α	0°	8°	0°	8°	-

NOTES:

1. Symbols are defined in the "MO Series Symbol List" in Section 2.2 of Publication Number 95.
2. Dimensioning and tolerancing per ANSI Y14.5M-1982.
3. Dimension "D" does not include mold flash, protrusions or gate burrs. Mold flash, protrusion and gate burrs shall not exceed 0.15mm (0.006 inch) per side.
4. Dimension "E" does not include interlead flash or protrusions. Interlead flash and protrusions shall not exceed 0.25mm (0.010 inch) per side.
5. The chamfer on the body is optional. If it is not present, a visual index feature must be located within the crosshatched area.
6. "L" is the length of terminal for soldering to a substrate.
7. "N" is the number of terminal positions.
8. Terminal numbers are shown for reference only.
9. The lead width "B", as measured 0.36mm (0.014 inch) or greater above the seating plane, shall not exceed a maximum value of 0.61mm (0.024 inch).
10. Controlling dimension: MILLIMETER. Converted inch dimensions are not necessarily exact.

Rev. 0 12/93

All Intersil U.S. products are manufactured, assembled and tested utilizing ISO9000 quality systems. Intersil Corporation's quality certifications can be viewed at www.intersil.com/design/quality

Intersil products are sold by description only. Intersil Corporation reserves the right to make changes in circuit design, software and/or specifications at any time without notice. Accordingly, the reader is cautioned to verify that data sheets are current before placing orders. Information furnished by Intersil is believed to be accurate and reliable. However, no responsibility is assumed by Intersil or its subsidiaries for its use; nor for any infringements of patents or other rights of third parties which may result from its use. No license is granted by implication or otherwise under any patent or patent rights of Intersil or its subsidiaries.

For information regarding Intersil Corporation and its products, see www.intersil.com