

Dual and Quad, 8MHz and 60MHz, Low Noise Operational Amplifiers

Low noise and high performance are key words describing HA-5102, HA-5104 and HA-5114. These general purpose amplifiers offer an array of dynamic specifications ranging from a 3V/μs slew rate and 8MHz bandwidth (5102/04) to 20V/μs slew rate and 60MHz gain-bandwidth-product (HA-5114). Complementing these outstanding parameters is a very low noise specification of 4.3nV/√Hz at 1kHz.

Fabricated using the Intersil high frequency DI process, these operational amplifiers also offer excellent input specifications such as a 0.5mV offset voltage and 30nA offset current. Complementing these specifications are 108dB open loop gain and 60dB channel separation. Consuming a very modest amount of power (90mW/package for duals and 150mW/package for quads), HA-5102/04/14 also provide 15mA of output current.

This impressive combination of features make this series of amplifiers ideally suited for designs ranging from audio amplifiers and active filters to the most demanding signal conditioning and instrumentation circuits.

These operational amplifiers are available in dual or quad form with industry standard pinouts allowing for immediate interchangeability with most other dual and quad operational amplifiers.

HA-5102 Dual, Comp. HA-5104 Quad, Comp.
 HA-5114 Quad, Uncomp.

Refer to the /883 data sheet for military product.

Ordering Information

| PART NUMBER | TEMP. RANGE (°C) | PACKAGE | PKG. NO |
|-------------|------------------|--------------|---------|
| HA3-5102-5 | 0 to 75 | 8 Ld PDIP | E8.3 |
| HA7-5102-2 | -55 to 125 | 8 Ld Cerdip | F8.3A |
| HA1-5104-2 | -55 to 125 | 14 Ld Cerdip | F14.3 |
| HA1-5104-5 | 0 to 75 | 14 Ld Cerdip | F14.3 |
| HA3-5104-5 | 0 to 75 | 14 Ld PDIP | E14.3 |
| HA9P5104-9 | -40 to 85 | 16 Ld SOIC | M16.3 |
| HA3-5114-5 | 0 to 75 | 14 Ld PDIP | E14.3 |
| HA9P5114-9 | -40 to 85 | 16 Ld SOIC | M16.3 |

Features

- Low Noise 4.3nV/√Hz
- Bandwidth 8MHz (Compensated)
60MHz (Uncompensated)
- Slew Rate 3V/μs (Compensated)
20V/μs (Uncompensated)
- Low Offset Voltage 0.5mV
- Available in Duals or Quads

Applications

- High Q, Active Filters
- Audio Amplifiers
- Instrumentation Amplifiers
- Integrators
- Signal Generators
- For Further Design Ideas, See Application Note AN554

Pinouts

HA-5102 (PDIP, Cerdip)
TOP VIEW

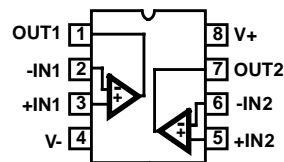

HA-5104 (PDIP, Cerdip)
HA-5114 (PDIP)
TOP VIEW

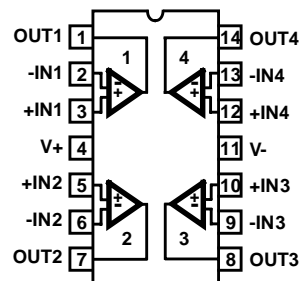

HA5104/5114 (SOIC)
TOP VIEW

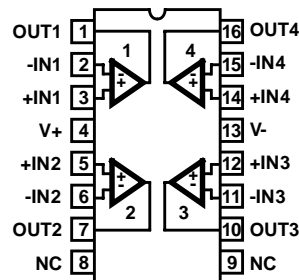

HA-5102, HA-5104, HA-5114

Absolute Maximum Ratings

| | |
|--|------------------|
| Supply Voltage Between V+ and V- Terminals | 40V |
| Differential Input Voltage | 7V |
| Input Voltage | $\pm V_{SUPPLY}$ |
| Output Short Circuit Duration (Note 3) | Indefinite |

Operating Conditions

| | |
|-------------------------------|----------------|
| Temperature Range | |
| HA-5102/5104-2 | -55°C to 125°C |
| HA-5102/5104/5114-5 | 0°C to 75°C |
| HA-5104/5114-9 | -40°C to 85°C |

Thermal Information

| | | |
|---|-------------------------|----------------------|
| Thermal Resistance (Typical, Note 2) | θ_{JA} (°C/W) | θ_{JC} (°C/W) |
| 8 Lead PDIP Package | 92 | N/A |
| 8 Lead CERDIP Package | 135 | 50 |
| 14 Lead CERDIP Package | 80 | 30 |
| 14 Lead PDIP Package | 86 | N/A |
| SOIC Package (HA-5104, HA-5114) | 96 | N/A |
| Maximum Junction Temperature (Note 1, Hermetic Package) | 175°C | |
| Maximum Junction Temperature (Plastic Package) | 150°C | |
| Maximum Storage Temperature Range | -65°C to 150°C | |
| Maximum Lead Temperature (Soldering 10s) | 300°C | |
| | (SOIC - Lead Tips Only) | |

CAUTION: Stresses above those listed in "Absolute Maximum Ratings" may cause permanent damage to the device. This is a stress only rating and operation of the device at these or any other conditions above those indicated in the operational sections of this specification is not implied.

NOTES:

- Maximum power dissipation, including output load, must be designed to maintain the maximum junction temperature below 175°C for hermetic packages, and below 150°C for plastic packages.
- θ_{JA} is measured with the component mounted on an evaluation PC board in free air.
- Any one amplifier may be shorted to ground indefinitely.

Electrical Specifications $V_{SUPPLY} = \pm 15V$, Unless Otherwise Specified

| PARAMETER | TEMP. (°C) | HA-5102-2, -5 | | | HA-5104-2, -5 HA-5114 -5 | | | HA-5104-9 HA-5114-9 | | | UNITS | |
|---|--------------|---------------|----------|-----|-----------------------------|----------|-----|------------------------|----------|-----|------------------|-----|
| | | MIN | TYP | MAX | MIN | TYP | MAX | MIN | TYP | MAX | | |
| INPUT CHARACTERISTICS | | | | | | | | | | | | |
| Offset Voltage | 25 | - | 0.5 | 2.0 | - | 0.5 | 2.5 | - | 0.5 | 2.5 | mV | |
| | Full | - | - | 2.5 | - | - | 3.0 | - | - | 3.0 | mV | |
| Offset Voltage Average Drift | Full | - | 3 | - | - | 3 | - | - | 3 | - | $\mu V/^\circ C$ | |
| Bias Current | 25 | - | 130 | 200 | - | 130 | 200 | - | 130 | 200 | nA | |
| | Full | - | - | 325 | - | - | 325 | - | - | 500 | nA | |
| Offset Current | 25 | - | 30 | 75 | - | 30 | 75 | - | 30 | 75 | nA | |
| | Full | - | - | 125 | - | - | 125 | - | - | 125 | nA | |
| Input Resistance | 25 | - | 500 | - | - | 500 | - | - | 500 | - | k Ω | |
| Common Mode Range | Full | ± 12 | - | - | ± 12 | - | - | ± 12 | - | - | V | |
| TRANSFER CHARACTERISTICS | | | | | | | | | | | | |
| Large Signal Voltage Gain, ($V_{OUT} = \pm 5V$, $R_L = 2k\Omega$) | 25 | 100 | 250 | - | 100 | 250 | - | 80 | 250 | - | kV/V | |
| | Full | 100 | - | - | 100 | - | - | 80 | - | - | kV/V | |
| Common Mode Rejection Ratio ($V_{CM} = \pm 5.0V$) | Full | 86 | 95 | - | 86 | 95 | - | 80 | 95 | - | dB | |
| Small Signal Bandwidth, HA-5102/5104 ($A_V = 1$) | 25 | - | 8 | - | - | 8 | - | - | 8 | - | MHz | |
| Gain Bandwidth Product, HA-5114 ($A_V = 10$) | 25 | - | 60 | - | - | 60 | - | - | 60 | - | MHz | |
| Channel Separation (Note 4) | 25 | - | 60 | - | - | 60 | - | - | 60 | - | dB | |
| OUTPUT CHARACTERISTICS | | | | | | | | | | | | |
| Output Voltage Swing ($R_L = 10k\Omega$) | Full | ± 12 | ± 13 | - | ± 12 | ± 13 | - | ± 12 | ± 13 | - | V | |
| | Full | ± 10 | ± 12 | - | ± 10 | ± 12 | - | ± 10 | ± 12 | - | V | |
| Output Current, ($V_{OUT} = \pm 5V$) | Full | ± 10 | ± 15 | - | ± 10 | ± 15 | - | ± 7 | ± 15 | - | mA | |
| Full Power Bandwidth (Note 5) | HA-5102/5104 | 25 | 16 | 47 | - | 16 | 47 | - | 16 | 47 | - | kHz |
| | HA-5114 | 25 | 191 | 318 | - | 191 | 318 | - | 191 | 318 | - | kHz |

HA-5102, HA-5104, HA-5114

Electrical Specifications $V_{SUPPLY} = \pm 15V$, Unless Otherwise Specified (Continued)

| PARAMETER | TEMP. (°C) | HA-5102-2, -5 | | | HA-5104-2, -5 HA-5114 -5 | | | HA-5104-9 HA-5114-9 | | | UNITS | |
|---|-----------------|---------------|-----|------|-----------------------------|-----|------|------------------------|-----|------|----------|-------------------|
| | | MIN | TYP | MAX | MIN | TYP | MAX | MIN | TYP | MAX | | |
| Output Resistance | 25 | - | 110 | - | - | 110 | - | - | 110 | - | Ω | |
| STABILITY | | | | | | | | | | | | |
| Minimum Stable Closed Loop Gain | HA-5102/5104 | Full | 1 | - | - | 1 | - | - | 1 | - | - | V/V |
| | HA-5114 | Full | 10 | - | - | 10 | - | - | 10 | - | - | V/V |
| TRANSIENT RESPONSE (Note 6) | | | | | | | | | | | | |
| Rise Time | HA-5102/5104 | 25 | - | 108 | 200 | - | 108 | 200 | - | 108 | 200 | ns |
| | HA-5114 | 25 | - | 48 | 100 | - | 48 | 100 | - | 48 | 100 | ns |
| Overshoot | HA-5102/5104 | 25 | - | 20 | 35 | - | 20 | 35 | - | 20 | 35 | % |
| | HA-5114 | 25 | - | 30 | 40 | - | 30 | 40 | - | 30 | 40 | % |
| Slew Rate | HA-5102/5104 | 25 | 1 | 3 | - | 1 | 3 | - | 1 | 3 | - | V/ μ s |
| | HA-5114 | 25 | 12 | 20 | - | 12 | 20 | - | 12 | 20 | - | V/ μ s |
| Settling Time (Note 7) | HA-5102/5104 | 25 | - | 4.5 | - | - | 4.5 | - | - | 4.5 | - | μ s |
| | HA-5114 | 25 | - | 0.6 | - | - | 0.6 | - | - | 0.6 | - | μ s |
| NOISE CHARACTERISTICS (Note 8) | | | | | | | | | | | | |
| Input Noise Voltage | f = 10Hz | 25 | - | 9 | 25 | - | 9 | 25 | - | 9 | 25 | nV/ \sqrt{Hz} |
| | f = 1kHz | 25 | - | 4.3 | 6.0 | - | 4.3 | 6.0 | - | 4.3 | 6.0 | nV/ \sqrt{Hz} |
| Input Noise Current | f = 10Hz | 25 | - | 5.1 | 15 | - | 5.1 | 15 | - | 5.1 | 15 | pA/ \sqrt{Hz} |
| | f = 1kHz | 25 | - | 0.57 | 3 | - | 0.57 | 3 | - | 0.57 | 3 | pA/ \sqrt{Hz} |
| Broadband Noise Voltage | f = DC to 30kHz | 25 | - | 870 | - | - | 870 | - | - | 870 | - | nV _{RMS} |
| POWER SUPPLY CHARACTERISTICS | | | | | | | | | | | | |
| Supply Current (All Amps) | | 25 | - | 3.0 | 5.0 | - | 5.0 | 6.5 | - | 5.0 | 6.5 | mA |
| Power Supply Rejection Ratio, ($\Delta V_S = \pm 5V$) | | Full | 86 | 100 | - | 86 | 100 | - | 80 | 100 | - | dB |

NOTES:

4. Channel separation value is referred to the input of the amplifier. Input test conditions are: f = 10kHz; $V_{IN} = 100mV_{PEAK}$; $R_S = 1k\Omega$.
5. Full power bandwidth is guaranteed by equation: Full power bandwidth = $\frac{\text{Slew Rate}}{2\pi V_{PEAK}}$.
6. Refer to Test Circuits section of the data sheet.
7. Settling time is measured to 0.1% of final value for a 1V input step, and $A_V = -10$ for HA-5114, and a 10V input step, $A_V = -1$ for HA-5102/5104.
8. The limits for these parameters are guaranteed based on lab characterization, and reflect lot-to-lot variation.

Test Circuits and Waveforms

HA-5102, HA-5104

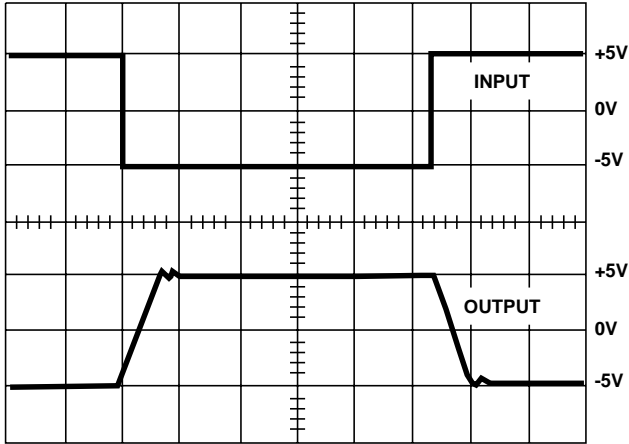
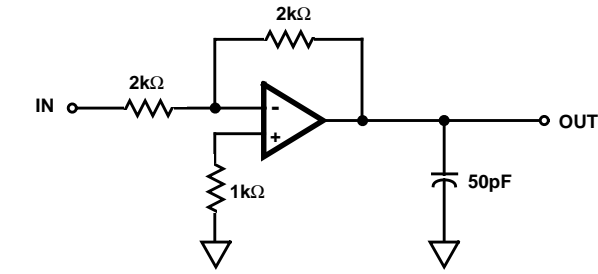

Vertical = 5V/Div., Horizontal = 5μs/Div. ($A_V = -1$)

FIGURE 1. LARGE SIGNAL RESPONSE CIRCUIT

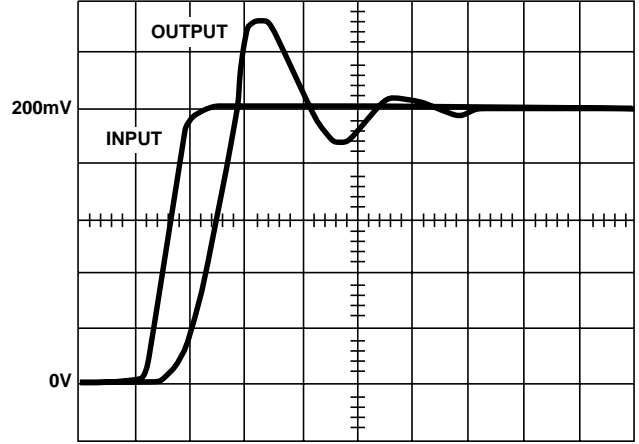
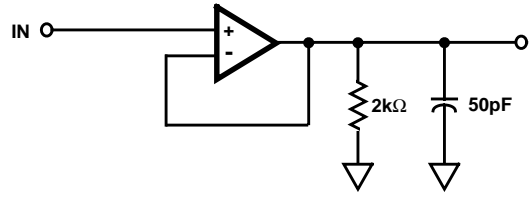

Vertical = 40mV/Div., Horizontal = 50ns/Div. ($A_V = +1$)

FIGURE 2. SMALL SIGNAL RESPONSE CIRCUIT

HA-5114

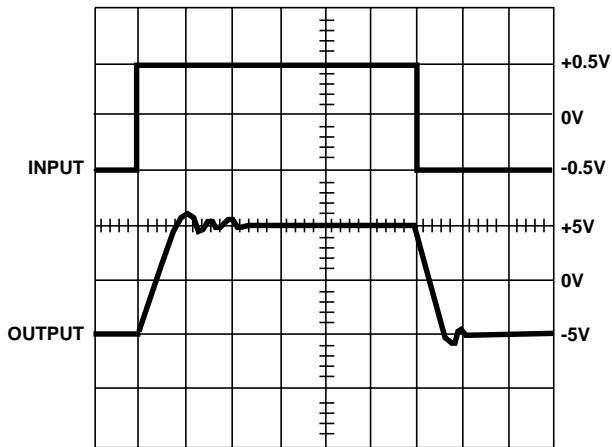

Input = 0.5V/Div., Output = 5V/Div., Time = 500ns/Div.

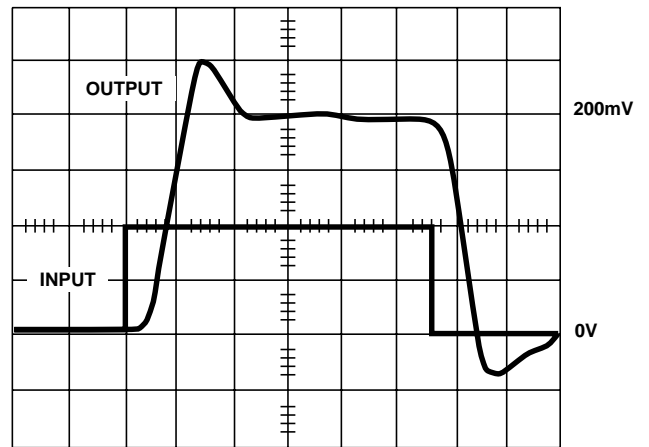

Input = 10mV/Div., Output = 50mV/Div., Time = 50ns/Div.

Test Circuits and Waveforms (Continued)

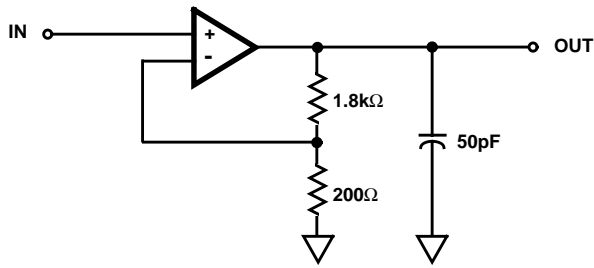

NOTE: $A_V = +10$.

FIGURE 3. LARGE AND SMALL SIGNAL RESPONSE CIRCUIT ($A_V = +10$)

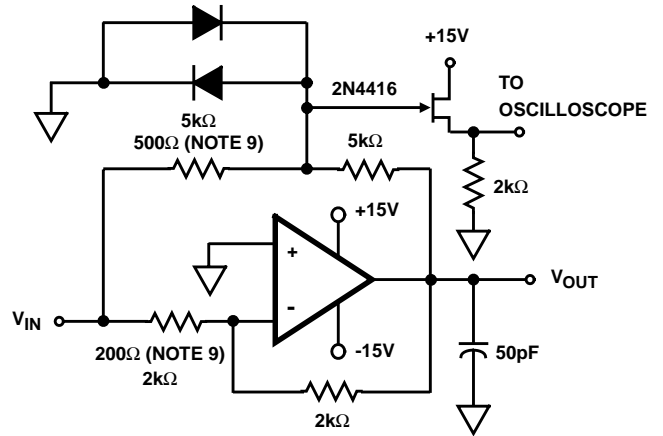

NOTES:

- 9. $A_V = -1$ (HA-5102/5104), $A_V = -10$ (HA-5114).
- 10. Feedback and summing resistors should be 0.1% matched.
- 11. Clipping diodes are optional, HP5082-2810 recommended.

FIGURE 4. SETTLING TIME CIRCUIT

Simplified Schematic

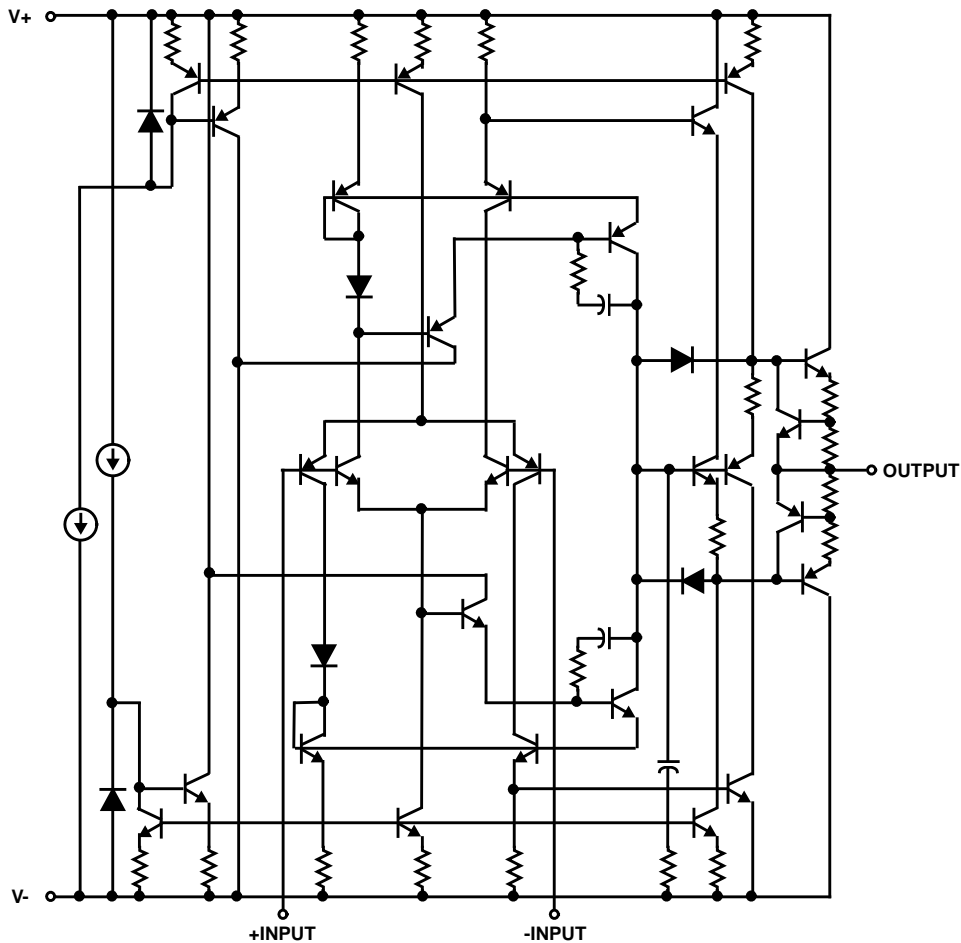

Typical Performance Curves

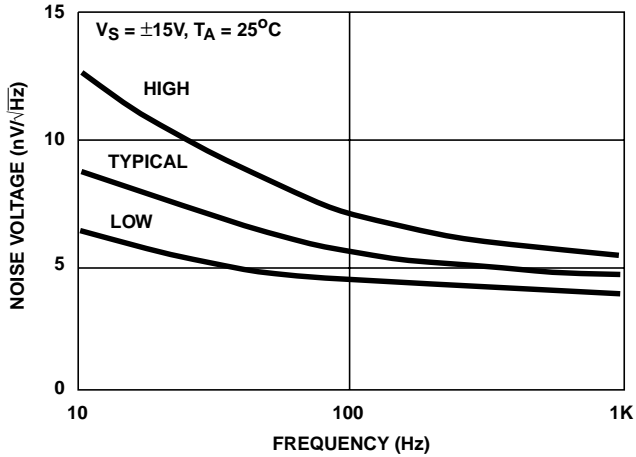

FIGURE 5. INPUT NOISE VOLTAGE DENSITY

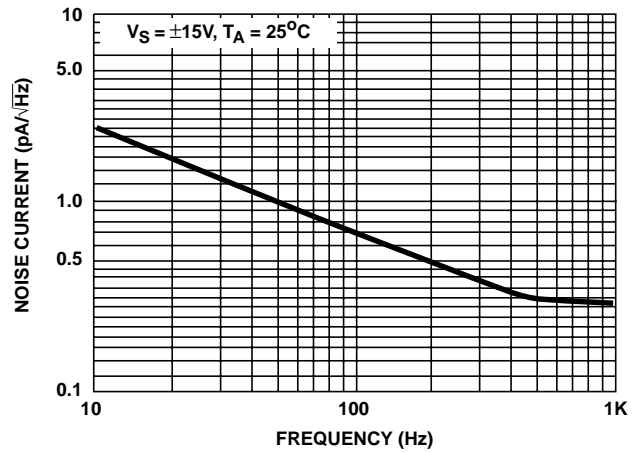

FIGURE 6. INPUT NOISE CURRENT DENSITY

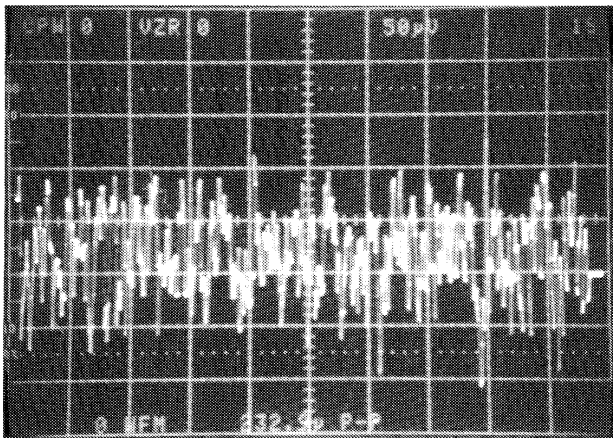

FIGURE 7. 0.1Hz TO 10Hz NOISE

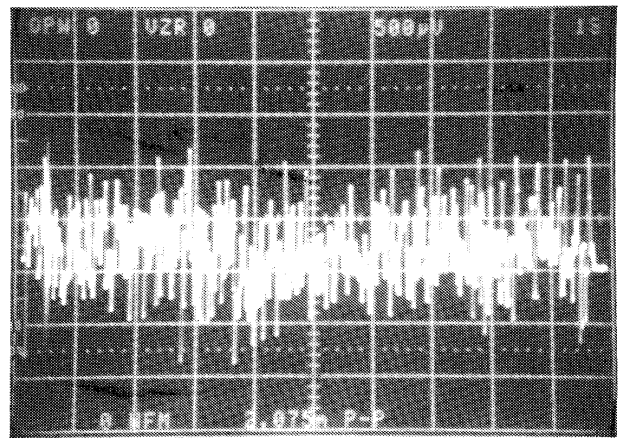

FIGURE 8. 0.1Hz TO 1MHz NOISE

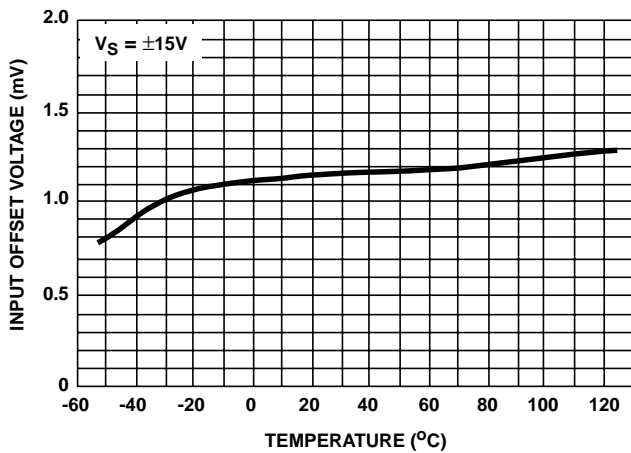

FIGURE 9. V_{IO} vs TEMPERATURE

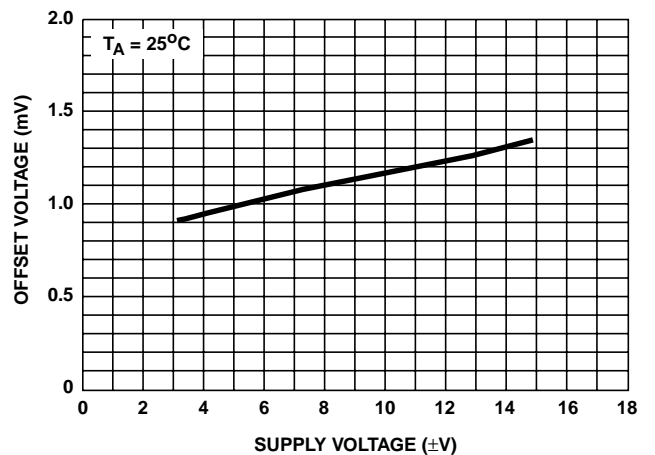

FIGURE 10. V_{IO} vs V_S

Typical Performance Curves (Continued)

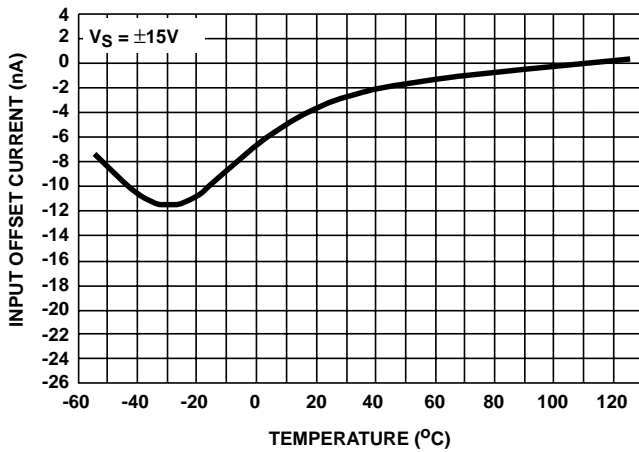

FIGURE 11. I_{IO} vs TEMPERATURE

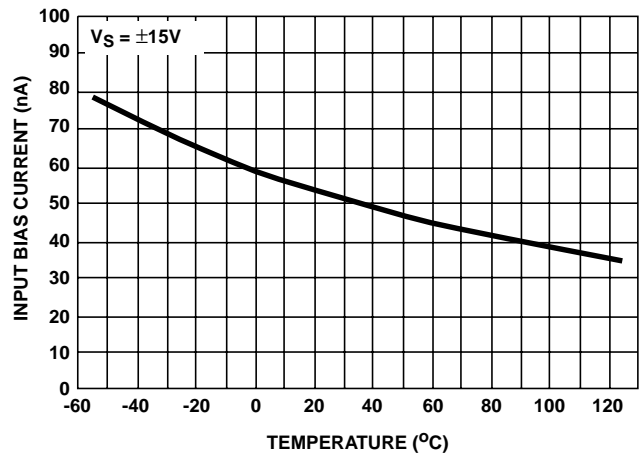

FIGURE 12. I_{BIAS} vs TEMPERATURE

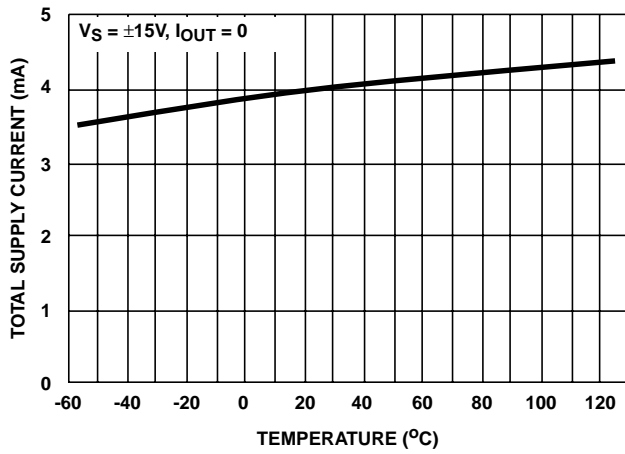

FIGURE 13. I_{CC} vs TEMPERATURE (HA-5104/14)

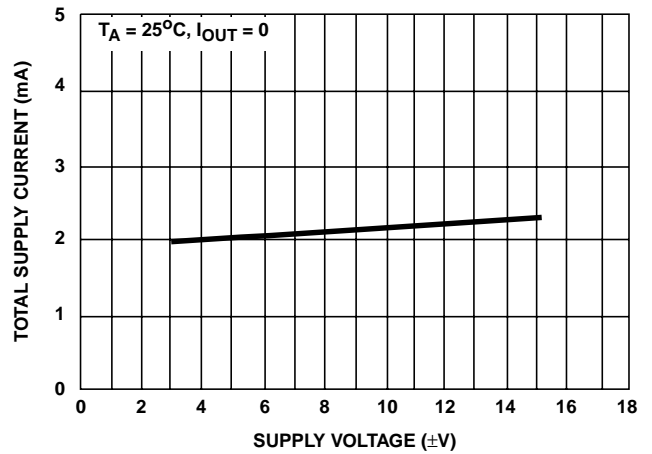

FIGURE 14. I_{CC} vs V_S (HA-5102)

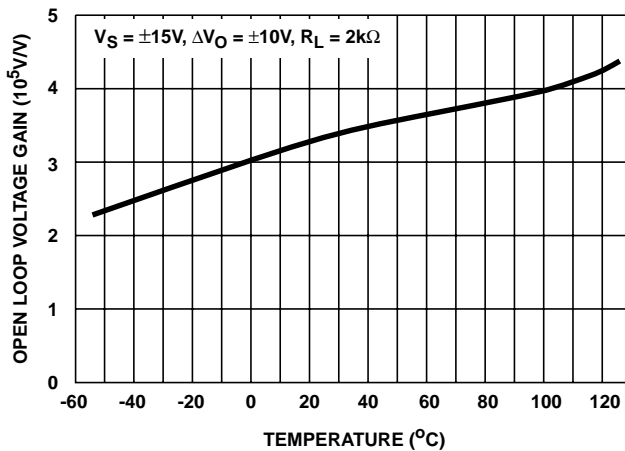

FIGURE 15. A_{VOL} vs TEMPERATURE

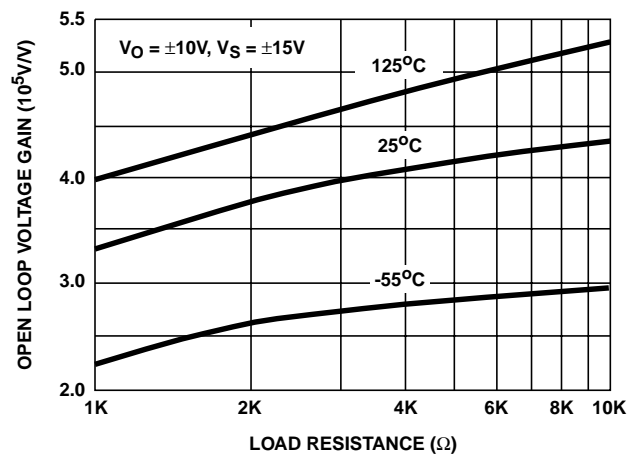

FIGURE 16. A_{VOL} vs LOAD RESISTANCE

Typical Performance Curves (Continued)

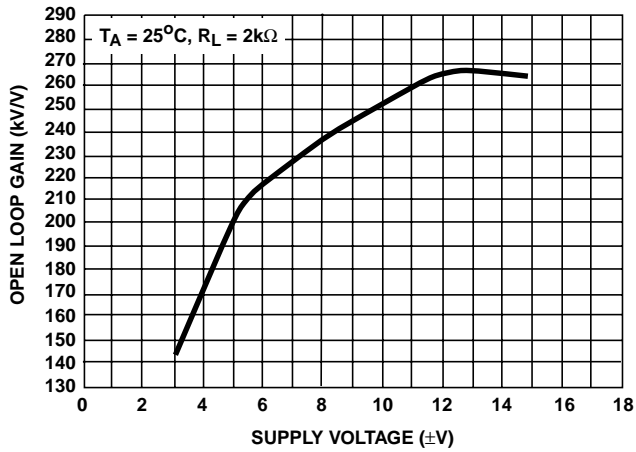

FIGURE 17. A_{VOL} vs V_S

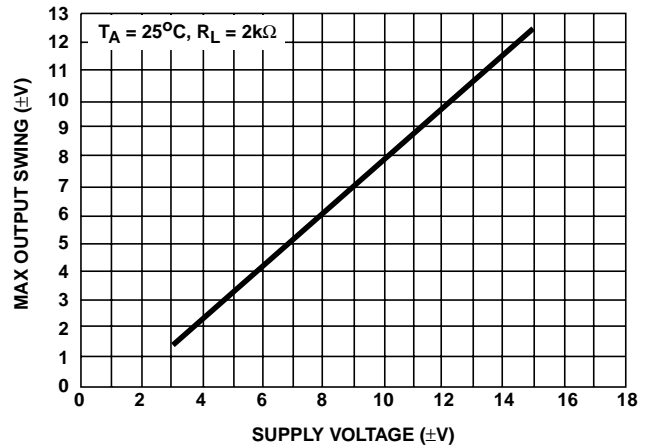

FIGURE 18. V_{OUT} vs V_S

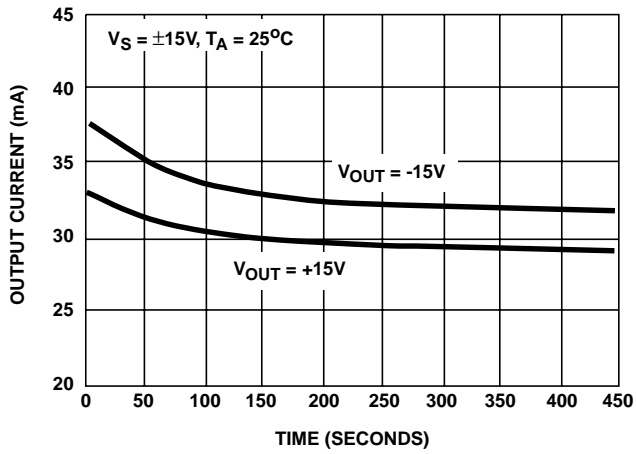

FIGURE 19. OUTPUT SHORT CIRCUIT CURRENT vs TIME

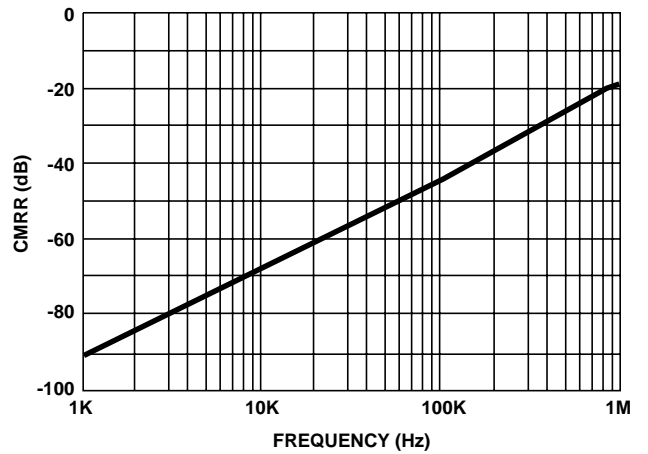

FIGURE 20. CMRR vs FREQUENCY

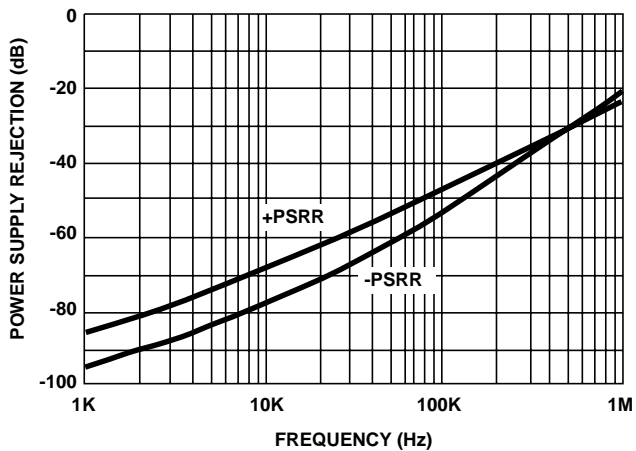

FIGURE 21. PSRR vs FREQUENCY

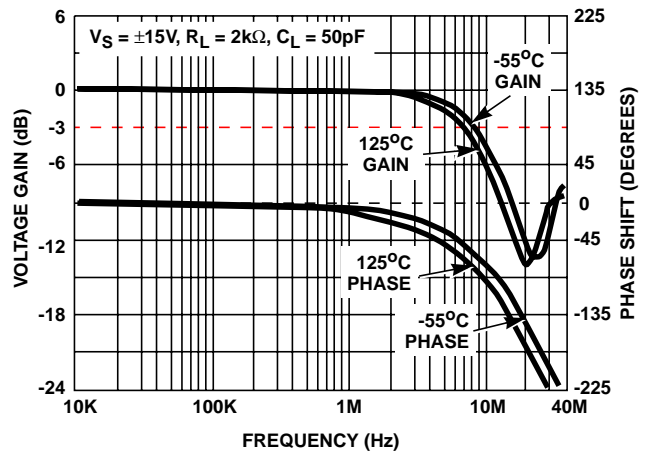

FIGURE 22. HA-5104/02 UNITY GAIN FREQUENCY RESPONSE

Typical Performance Curves (Continued)

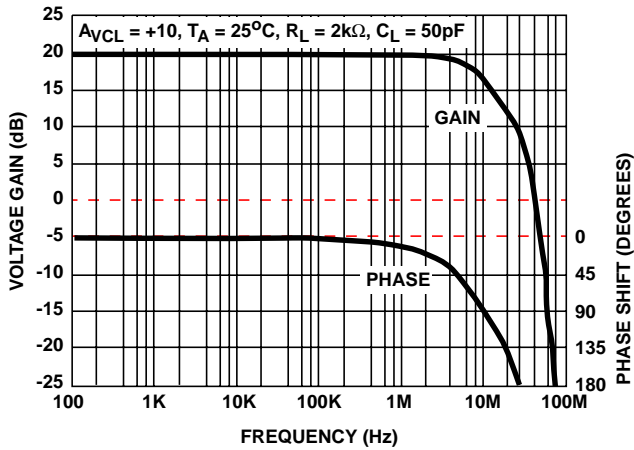

FIGURE 23. HA-5114 FREQUENCY RESPONSE

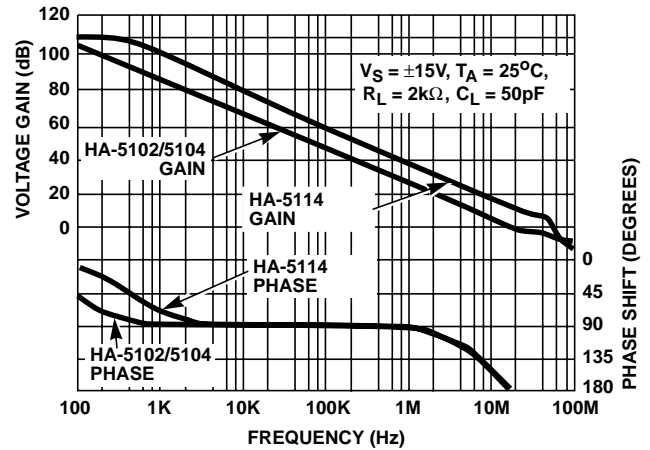

FIGURE 24. OPEN LOOP GAIN vs FREQUENCY

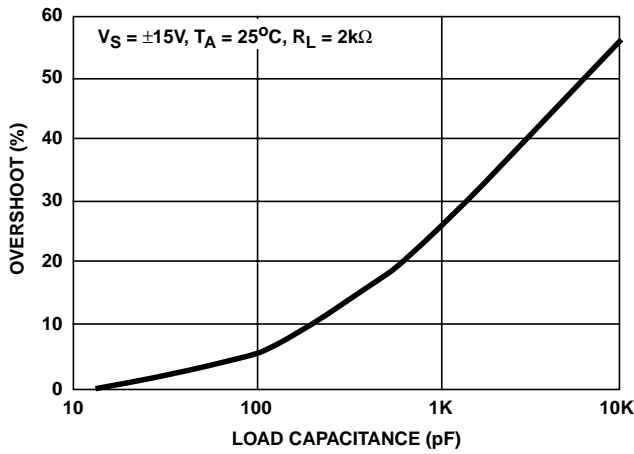

FIGURE 25. SMALL SIGNAL OVERSHOOT vs C_{LOAD}

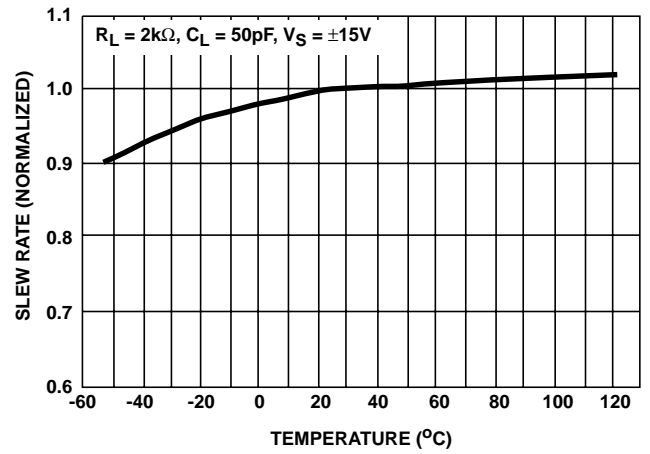

FIGURE 26. SLEW RATE vs TEMPERATURE

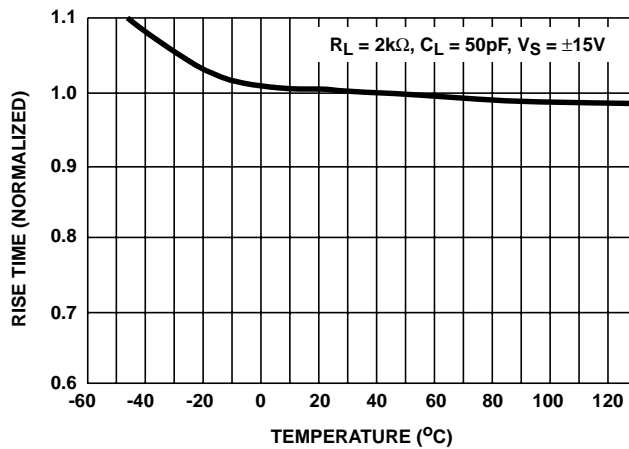

FIGURE 27. RISE TIME vs TEMPERATURE

Die Characteristics

DIE DIMENSIONS:

98.4 mils x 67.3 mils x 19 mils
2500µm x 1710µm x 483µm

METALLIZATION:

Type: Al, 1% Cu
Thickness: 16kÅ ±2kÅ

PASSIVATION:

Type: Nitride (Si₃N₄) over Silox (SiO₂, 5% Phos.)
Silox Thickness: 12kÅ ±2kÅ
Nitride Thickness: 3.5kÅ ±1.5kÅ

SUBSTRATE POTENTIAL (POWERED UP):

Unbiased

TRANSISTOR COUNT:

93

PROCESS:

Bipolar Dielectric Isolation

Metallization Mask Layout

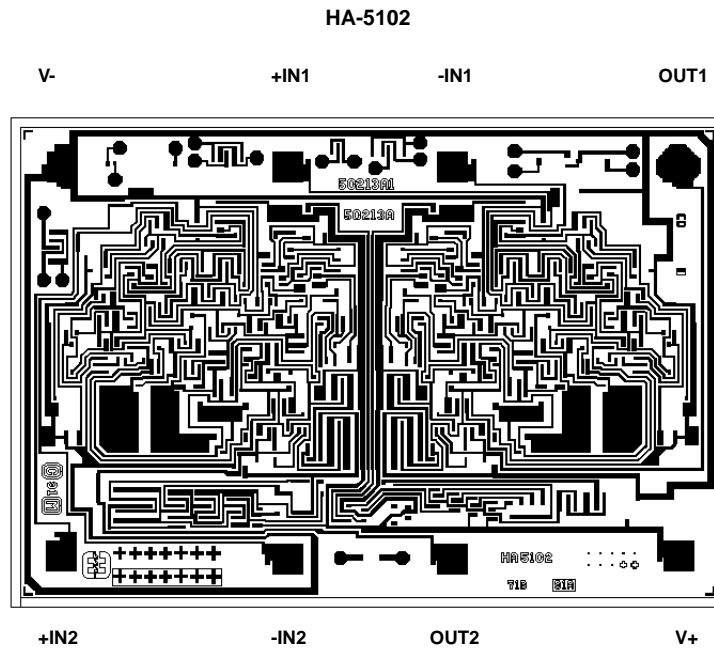

Die Characteristics

DIE DIMENSIONS:

95 mils x 99 mils x 19 mils
 2420 μ m x 2530 μ m x 483 μ m

METALLIZATION:

Type: Al, 1% Cu
 Thickness: 16k \AA \pm 2k \AA

PASSIVATION:

Type: Nitride (Si₃N₄) over Silox (SiO₂, 5% Phos.)
 Silox Thickness: 12k \AA \pm 2k \AA
 Nitride Thickness: 3.5k \AA \pm 1.5k \AA

SUBSTRATE POTENTIAL (POWERED UP):

Unbiased

TRANSISTOR COUNT:

175

PROCESS:

Bipolar Dielectric Isolation

Metallization Mask Layout

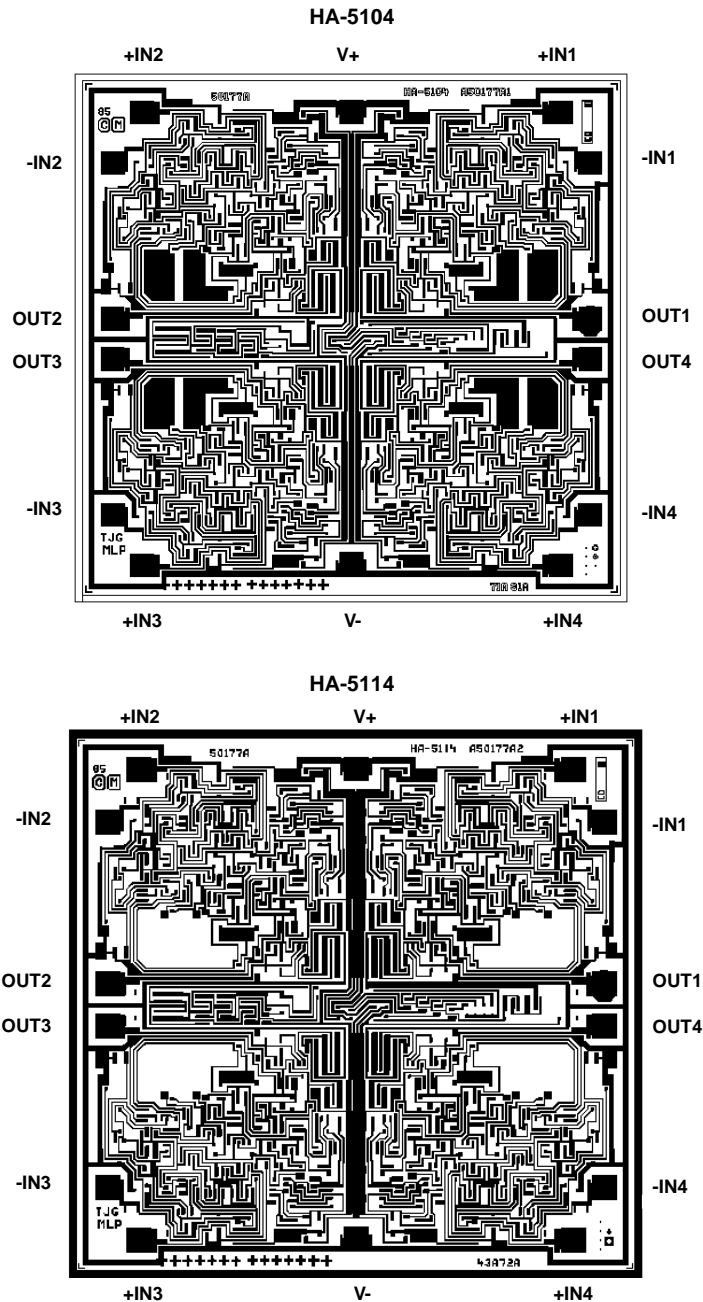

Dual-In-Line Plastic Packages (PDIP)

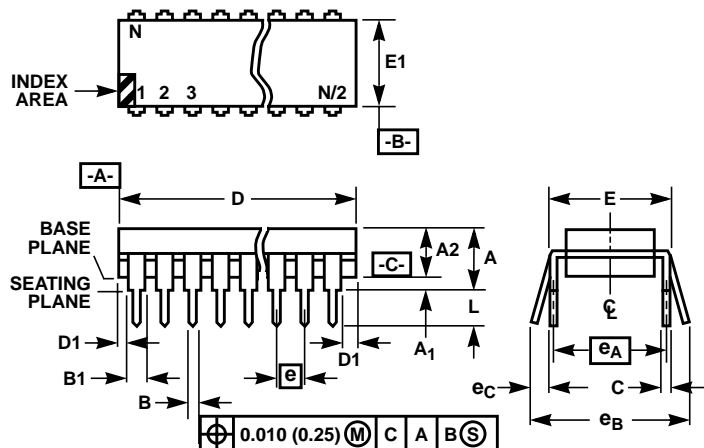

NOTES:

- Controlling Dimensions: INCH. In case of conflict between English and Metric dimensions, the inch dimensions control.
- Dimensioning and tolerancing per ANSI Y14.5M-1982.
- Symbols are defined in the "MO Series Symbol List" in Section 2.2 of Publication No. 95.
- Dimensions A, A1 and L are measured with the package seated in JEDEC seating plane gauge GS-3.
- D, D1, and E1 dimensions do not include mold flash or protrusions. Mold flash or protrusions shall not exceed 0.010 inch (0.25mm).
- E and e_A are measured with the leads constrained to be perpendicular to datum $-C-$.
- e_B and e_C are measured at the lead tips with the leads unconstrained. e_C must be zero or greater.
- B1 maximum dimensions do not include dambar protrusions. Dambar protrusions shall not exceed 0.010 inch (0.25mm).
- N is the maximum number of terminal positions.
- Corner leads (1, N, N/2 and N/2 + 1) for E8.3, E16.3, E18.3, E28.3, E42.6 will have a B1 dimension of 0.030 - 0.045 inch (0.76 - 1.14mm).

E8.3 (JEDEC MS-001-BA ISSUE D)
8 LEAD DUAL-IN-LINE PLASTIC PACKAGE

| SYMBOL | INCHES | | MILLIMETERS | | NOTES |
|--------|-----------|-------|-------------|-------|-------|
| | MIN | MAX | MIN | MAX | |
| A | - | 0.210 | - | 5.33 | 4 |
| A1 | 0.015 | - | 0.39 | - | 4 |
| A2 | 0.115 | 0.195 | 2.93 | 4.95 | - |
| B | 0.014 | 0.022 | 0.356 | 0.558 | - |
| B1 | 0.045 | 0.070 | 1.15 | 1.77 | 8, 10 |
| C | 0.008 | 0.014 | 0.204 | 0.355 | - |
| D | 0.355 | 0.400 | 9.01 | 10.16 | 5 |
| D1 | 0.005 | - | 0.13 | - | 5 |
| E | 0.300 | 0.325 | 7.62 | 8.25 | 6 |
| E1 | 0.240 | 0.280 | 6.10 | 7.11 | 5 |
| e | 0.100 BSC | | 2.54 BSC | | - |
| e_A | 0.300 BSC | | 7.62 BSC | | 6 |
| e_B | - | 0.430 | - | 10.92 | 7 |
| L | 0.115 | 0.150 | 2.93 | 3.81 | 4 |
| N | 8 | | 8 | | 9 |

Rev. 0 12/93

Dual-In-Line Plastic Packages (PDIP)

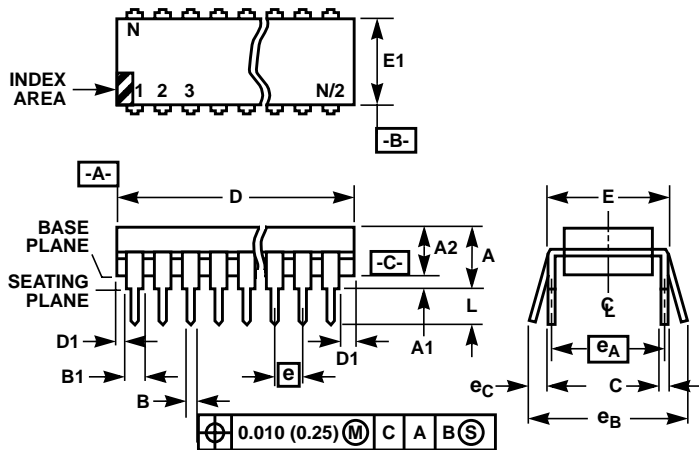

NOTES:

1. Controlling Dimensions: INCH. In case of conflict between English and Metric dimensions, the inch dimensions control.
2. Dimensioning and tolerancing per ANSI Y14.5M-1982.
3. Symbols are defined in the "MO Series Symbol List" in Section 2.2 of Publication No. 95.
4. Dimensions A, A1 and L are measured with the package seated in JEDEC seating plane gauge GS-3.
5. D, D1, and E1 dimensions do not include mold flash or protrusions. Mold flash or protrusions shall not exceed 0.010 inch (0.25mm).
6. E and e_A are measured with the leads constrained to be perpendicular to datum [-C-].
7. e_B and e_C are measured at the lead tips with the leads unconstrained. e_C must be zero or greater.
8. B1 maximum dimensions do not include dambar protrusions. Dambar protrusions shall not exceed 0.010 inch (0.25mm).
9. N is the maximum number of terminal positions.
10. Corner leads (1, N, N/2 and N/2 + 1) for E8.3, E16.3, E18.3, E28.3, E42.6 will have a B1 dimension of 0.030 - 0.045 inch (0.76 - 1.14mm).

E14.3 (JEDEC MS-001-AA ISSUE D)
14 LEAD DUAL-IN-LINE PLASTIC PACKAGE

| SYMBOL | INCHES | | MILLIMETERS | | NOTES |
|--------|-----------|-------|-------------|-------|-------|
| | MIN | MAX | MIN | MAX | |
| A | - | 0.210 | - | 5.33 | 4 |
| A1 | 0.015 | - | 0.39 | - | 4 |
| A2 | 0.115 | 0.195 | 2.93 | 4.95 | - |
| B | 0.014 | 0.022 | 0.356 | 0.558 | - |
| B1 | 0.045 | 0.070 | 1.15 | 1.77 | 8 |
| C | 0.008 | 0.014 | 0.204 | 0.355 | - |
| D | 0.735 | 0.775 | 18.66 | 19.68 | 5 |
| D1 | 0.005 | - | 0.13 | - | 5 |
| E | 0.300 | 0.325 | 7.62 | 8.25 | 6 |
| E1 | 0.240 | 0.280 | 6.10 | 7.11 | 5 |
| e | 0.100 BSC | | 2.54 BSC | | - |
| e_A | 0.300 BSC | | 7.62 BSC | | 6 |
| e_B | - | 0.430 | - | 10.92 | 7 |
| L | 0.115 | 0.150 | 2.93 | 3.81 | 4 |
| N | 14 | | 14 | | 9 |

Rev. 0 12/93

Ceramic Dual-In-Line Frit Seal Packages (CERDIP)

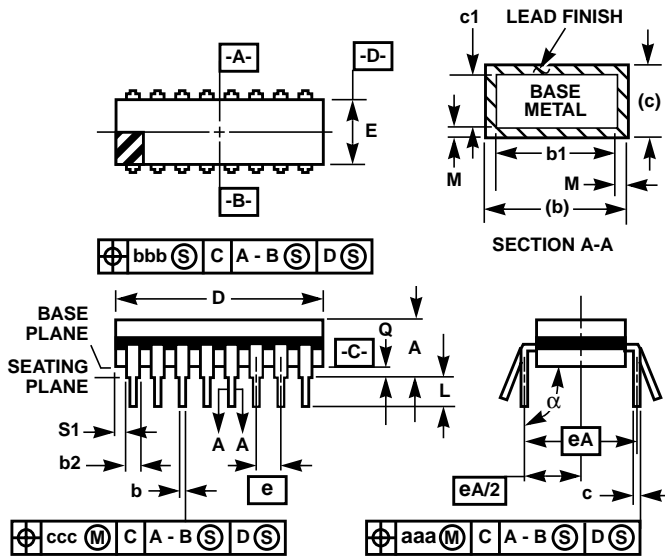

**F8.3A MIL-STD-1835 GDIP1-T8 (D-4, CONFIGURATION A)
8 LEAD CERAMIC DUAL-IN-LINE FRIT SEAL PACKAGE**

| SYMBOL | INCHES | | MILLIMETERS | | NOTES |
|--------|-----------|--------|-------------|-------|-------|
| | MIN | MAX | MIN | MAX | |
| A | - | 0.200 | - | 5.08 | - |
| b | 0.014 | 0.026 | 0.36 | 0.66 | 2 |
| b1 | 0.014 | 0.023 | 0.36 | 0.58 | 3 |
| b2 | 0.045 | 0.065 | 1.14 | 1.65 | - |
| b3 | 0.023 | 0.045 | 0.58 | 1.14 | 4 |
| c | 0.008 | 0.018 | 0.20 | 0.46 | 2 |
| c1 | 0.008 | 0.015 | 0.20 | 0.38 | 3 |
| D | - | 0.405 | - | 10.29 | 5 |
| E | 0.220 | 0.310 | 5.59 | 7.87 | 5 |
| e | 0.100 BSC | | 2.54 BSC | | - |
| eA | 0.300 BSC | | 7.62 BSC | | - |
| eA/2 | 0.150 BSC | | 3.81 BSC | | - |
| L | 0.125 | 0.200 | 3.18 | 5.08 | - |
| Q | 0.015 | 0.060 | 0.38 | 1.52 | 6 |
| S1 | 0.005 | - | 0.13 | - | 7 |
| α | 90° | 105° | 90° | 105° | - |
| aaa | - | 0.015 | - | 0.38 | - |
| bbb | - | 0.030 | - | 0.76 | - |
| ccc | - | 0.010 | - | 0.25 | - |
| M | - | 0.0015 | - | 0.038 | 2, 3 |
| N | 8 | | 8 | | 8 |

NOTES:

1. Index area: A notch or a pin one identification mark shall be located adjacent to pin one and shall be located within the shaded area shown. The manufacturer's identification shall not be used as a pin one identification mark.
2. The maximum limits of lead dimensions b and c or M shall be measured at the centroid of the finished lead surfaces, when solder dip or tin plate lead finish is applied.
3. Dimensions b1 and c1 apply to lead base metal only. Dimension M applies to lead plating and finish thickness.
4. Corner leads (1, N, N/2, and N/2+1) may be configured with a partial lead paddle. For this configuration dimension b3 replaces dimension b2.
5. This dimension allows for off-center lid, meniscus, and glass overrun.
6. Dimension Q shall be measured from the seating plane to the base plane.
7. Measure dimension S1 at all four corners.
8. N is the maximum number of terminal positions.
9. Dimensioning and tolerancing per ANSI Y14.5M - 1982.
10. Controlling dimension: INCH

Rev. 0 4/94

Ceramic Dual-In-Line Frit Seal Packages (CERDIP)

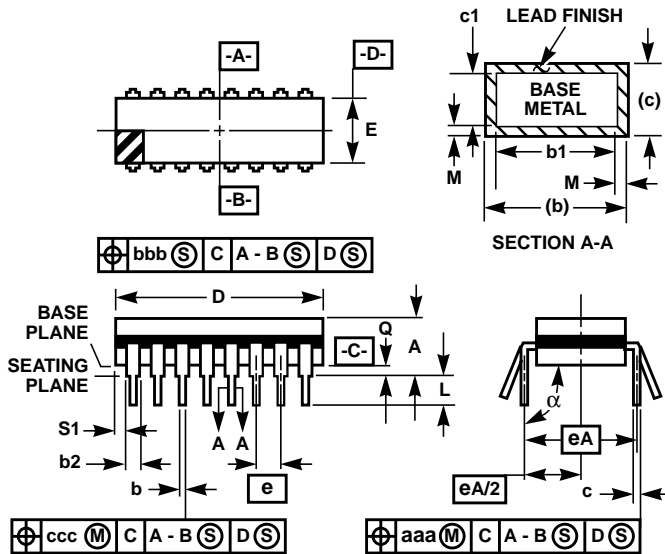

**F14.3 MIL-STD-1835 GDIP1-T14 (D-1, CONFIGURATION A)
14 LEAD CERAMIC DUAL-IN-LINE FRIT SEAL PACKAGE**

| SYMBOL | INCHES | | MILLIMETERS | | NOTES |
|----------|-----------|--------|-------------|-------|-------|
| | MIN | MAX | MIN | MAX | |
| A | - | 0.200 | - | 5.08 | - |
| b | 0.014 | 0.026 | 0.36 | 0.66 | 2 |
| b1 | 0.014 | 0.023 | 0.36 | 0.58 | 3 |
| b2 | 0.045 | 0.065 | 1.14 | 1.65 | - |
| b3 | 0.023 | 0.045 | 0.58 | 1.14 | 4 |
| c | 0.008 | 0.018 | 0.20 | 0.46 | 2 |
| c1 | 0.008 | 0.015 | 0.20 | 0.38 | 3 |
| D | - | 0.785 | - | 19.94 | 5 |
| E | 0.220 | 0.310 | 5.59 | 7.87 | 5 |
| e | 0.100 BSC | | 2.54 BSC | | - |
| eA | 0.300 BSC | | 7.62 BSC | | - |
| eA/2 | 0.150 BSC | | 3.81 BSC | | - |
| L | 0.125 | 0.200 | 3.18 | 5.08 | - |
| Q | 0.015 | 0.060 | 0.38 | 1.52 | 6 |
| S1 | 0.005 | - | 0.13 | - | 7 |
| α | 90° | 105° | 90° | 105° | - |
| aaa | - | 0.015 | - | 0.38 | - |
| bbb | - | 0.030 | - | 0.76 | - |
| ccc | - | 0.010 | - | 0.25 | - |
| M | - | 0.0015 | - | 0.038 | 2, 3 |
| N | 14 | | 14 | | 8 |

NOTES:

1. Index area: A notch or a pin one identification mark shall be located adjacent to pin one and shall be located within the shaded area shown. The manufacturer's identification shall not be used as a pin one identification mark.
2. The maximum limits of lead dimensions b and c or M shall be measured at the centroid of the finished lead surfaces, when solder dip or tin plate lead finish is applied.
3. Dimensions b1 and c1 apply to lead base metal only. Dimension M applies to lead plating and finish thickness.
4. Corner leads (1, N, N/2, and N/2+1) may be configured with a partial lead paddle. For this configuration dimension b3 replaces dimension b2.
5. This dimension allows for off-center lid, meniscus, and glass overrun.
6. Dimension Q shall be measured from the seating plane to the base plane.
7. Measure dimension S1 at all four corners.
8. N is the maximum number of terminal positions.
9. Dimensioning and tolerancing per ANSI Y14.5M - 1982.
10. Controlling dimension: INCH.

Rev. 0 4/94

Small Outline Plastic Packages (SOIC)

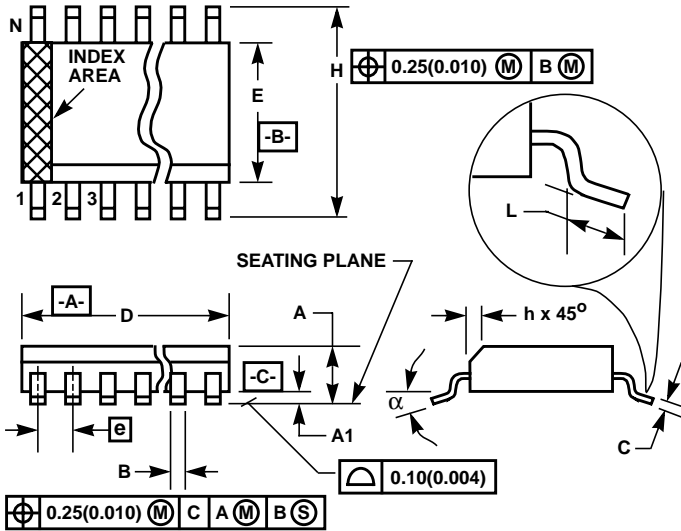

**M16.3 (JEDEC MS-013-AA ISSUE C)
16 LEAD WIDE BODY SMALL OUTLINE PLASTIC PACKAGE**

| SYMBOL | INCHES | | MILLIMETERS | | NOTES |
|----------|-----------|--------|-------------|-------|-------|
| | MIN | MAX | MIN | MAX | |
| A | 0.0926 | 0.1043 | 2.35 | 2.65 | - |
| A1 | 0.0040 | 0.0118 | 0.10 | 0.30 | - |
| B | 0.013 | 0.0200 | 0.33 | 0.51 | 9 |
| C | 0.0091 | 0.0125 | 0.23 | 0.32 | - |
| D | 0.3977 | 0.4133 | 10.10 | 10.50 | 3 |
| E | 0.2914 | 0.2992 | 7.40 | 7.60 | 4 |
| e | 0.050 BSC | | 1.27 BSC | | - |
| H | 0.394 | 0.419 | 10.00 | 10.65 | - |
| h | 0.010 | 0.029 | 0.25 | 0.75 | 5 |
| L | 0.016 | 0.050 | 0.40 | 1.27 | 6 |
| N | 16 | | 16 | | 7 |
| α | 0° | 8° | 0° | 8° | - |

NOTES:

1. Symbols are defined in the "MO Series Symbol List" in Section 2.2 of Publication Number 95.
2. Dimensioning and tolerancing per ANSI Y14.5M-1982.
3. Dimension "D" does not include mold flash, protrusions or gate burrs. Mold flash, protrusion and gate burrs shall not exceed 0.15mm (0.006 inch) per side.
4. Dimension "E" does not include interlead flash or protrusions. Interlead flash and protrusions shall not exceed 0.25mm (0.010 inch) per side.
5. The chamfer on the body is optional. If it is not present, a visual index feature must be located within the crosshatched area.
6. "L" is the length of terminal for soldering to a substrate.
7. "N" is the number of terminal positions.
8. Terminal numbers are shown for reference only.
9. The lead width "B", as measured 0.36mm (0.014 inch) or greater above the seating plane, shall not exceed a maximum value of 0.61mm (0.024 inch)
10. Controlling dimension: MILLIMETER. Converted inch dimensions are not necessarily exact.

Rev. 0 12/93

All Intersil semiconductor products are manufactured, assembled and tested under **ISO9000** quality systems certification.

Intersil semiconductor products are sold by description only. Intersil Corporation reserves the right to make changes in circuit design and/or specifications at any time without notice. Accordingly, the reader is cautioned to verify that data sheets are current before placing orders. Information furnished by Intersil is believed to be accurate and reliable. However, no responsibility is assumed by Intersil or its subsidiaries for its use; nor for any infringements of patents or other rights of third parties which may result from its use. No license is granted by implication or otherwise under any patent or patent rights of Intersil or its subsidiaries.

For information regarding Intersil Corporation and its products, see web site www.intersil.com

Sales Office Headquarters

NORTH AMERICA
Intersil Corporation
P. O. Box 883, Mail Stop 53-204
Melbourne, FL 32902
TEL: (321) 724-7000
FAX: (321) 724-7240

EUROPE
Intersil SA
Mercure Center
100, Rue de la Fusee
1130 Brussels, Belgium
TEL: (32) 2.724.2111
FAX: (32) 2.724.22.05

ASIA
Intersil (Taiwan) Ltd.
7F-6, No. 101 Fu Hsing North Road
Taipei, Taiwan
Republic of China
TEL: (886) 2 2716 9310
FAX: (886) 2 2715 3029