HA12216F/HA12221F Series

Audio Signal Processor for Car Deck
(Decode only Dolby B type NR with PB Amp.)

HITACHI

ADE-207-254E (Z)

6th Edition
Dec. 2000

Description

HA12216F/HA12221F series are silicon monolithic bipolar IC providing Dolby B type noise reduction, music sensor, PB equalizer system in one chip.

- Note:
1. Dolby is a trademark of Dolby Laboratories Licensing Corporation.
A license from Dolby Laboratories Licensing Corporation is required for the use of this IC.
 2. HA12221F series does not include Dolby B NR.

Functions

- PB equalizer × 2 channel
- Music sensor × 1 channel
- Dolby B NR (Only HA12216F series) × 2 channel
- Line mute (Tape radio) SW × 2 channel

Features

- Different type of PB equalizer characteristics selection (120 μ s/70 μ s) is available with fully electronic control switching built-in.
- Changeable to Forward, Reverse-mode for PB head with fully electronic control switching built-in.
- Available to change music sensing level by external resistor.
- Available to change response of music sensor by external capacitor.
- Music sensing level, built-in switch to change a band (MSG_v).
- NR ON/OFF fully electronic control switching built-in. (Only HA12216F series)
- Line mute (Tape radio) control switching built-in.
- Available to connect direct with MPU.
- These ICs are strong for a cellular phone noise. (18 dB improvement from HA12163)

HA12216F/HA12221F Series

Ordering Information

Operating Voltage

Product	Min	Max	Unit
HA12216F/HA12221F	6.5	12	V
HA12217F/HA12222F	6.8	12	V
HA12218F/HA12223F	7.2	12	V

Note: 1. These ICs are designed to operate on single supply.
2. HA12217F and HA12218F, HA12222F and HA12223F are develop, there meets comply with your demands.

Standard Level

Product	Package	PB-OUT Level
HA12216F/HA12221F	FP-40	300 mVrms
HA12217F/HA12222F	FP-40	387.5 mVrms
HA12218F/HA12223F	FP-40	450 mVrms

Function

Product	PB-EQ	Music Sensor	Mute	Dolby B NR
HA12216F series	○	○	○	○
HA12221F series	○	○	○	×

Parallel-Data Format

Pin No.	Pin Name	Lo	Hi
10	TAPE/RADIO	TAPE	RADIO
11*	NR ON/OFF	NR OFF	NR ON
12	120 μ /70 μ	120 μ (Normal)	70 μ (Metal or Chrome)
13	Forward/Reverse	Forward	Reverse
14	Search/Repeat	Search (FF or REV)	Repeat (Normal Speed)

Note: Non connection regarding HA12221F series.

HA12216F/HA12221F Series

Pin Description, Equivalent Circuit ($V_{CC} = 9\text{ V}$, A system of single supply voltage, $T_a = 25^\circ\text{C}$, No Signal, The value in the show typical value.)

Pin No.	Terminal Name	Note	Equivalent Circuit	Pin Description
18	MSI	$V = V_{CC}/2$		MS input *1
28	TAI (L)			Tape input
3	TAI (R)			
26	RAI (L)			Radio input (Mute)
5	RAI (R)			
23 *2	DET (L)	$V = 2.5\text{V}$		Time constant pin for rectifier
8 *2	DET (R)			
33	RIP	$V = V_{CC}/2$		Ripple filter
4 *2	Bias	$V = 0.28\text{V}$		Dolby bias current input
17	MSDET	—		Time constant pin for rectifier

- Note: 1. MS: Music Sensor
2. Non connection regarding HA12221F series.

HA12216F/HA12221F Series

Pin Description, Equivalent Circuit ($V_{CC} = 9\text{ V}$, A system of single supply voltage, $T_a = 25^\circ\text{C}$, No Signal, The value in the show typical value.) (cont)

Pin No.	Terminal Name	Note	Equivalent Circuit	Pin Description
25	PBOUT (L)	$V = V_{CC}/2$		PB output
6	PBOUT (R)			
19	MAOUT	$V = V_{CC}/2$		MS amp. output *1
38	VREF			Reference output
29	EQOUT (L)			Equalizer output (120μ)
2	EQOUT (R)			
30	M-OUT (L)	$V = V_{CC}/2$		Equalizer output (70μ)
1	M-OUT (R)			
16	V_{CC}	—		Power supply
7	NC	—		No connection
9				
22				
24				
27				

Note: 1. MS: Music Sensor

HA12216F/HA12221F Series

Pin Description, Equivalent Circuit ($V_{CC} = 9\text{ V}$, A system of single supply voltage, $T_a = 25^\circ\text{C}$, No Signal, The value in the show typical value.) (cont)

Pin No.	Terminal Name	Note	Equivalent Circuit	Pin Description
34	FIN (L)	—		Equalizer input (Forward)
37	FIN (R)			
32	RIN (L)			Equalizer input (Reverse)
39	RIN (R)			
31	NFI (L)			Negative feedback
40	NFI (R)			
10	T/R (Mute)	—		Mode control input
11 *2	NR ON/OFF			
12	120/70			
13	F/R			
14	S/R (MS G_V)			
15	MSOUT	—		MS output (to MPU) *1
20	MS G_V (R)	$V = V_{CC}/2$		MS gain terminal *1
21	MS G_V (S)			
35	GND	—		GND pin
36				

Note: 1. MS: Music Sensor
2. Non connection regarding HA12221F series.

HA12216F/HA12221F Series

Block Diagram

HA12216F Series

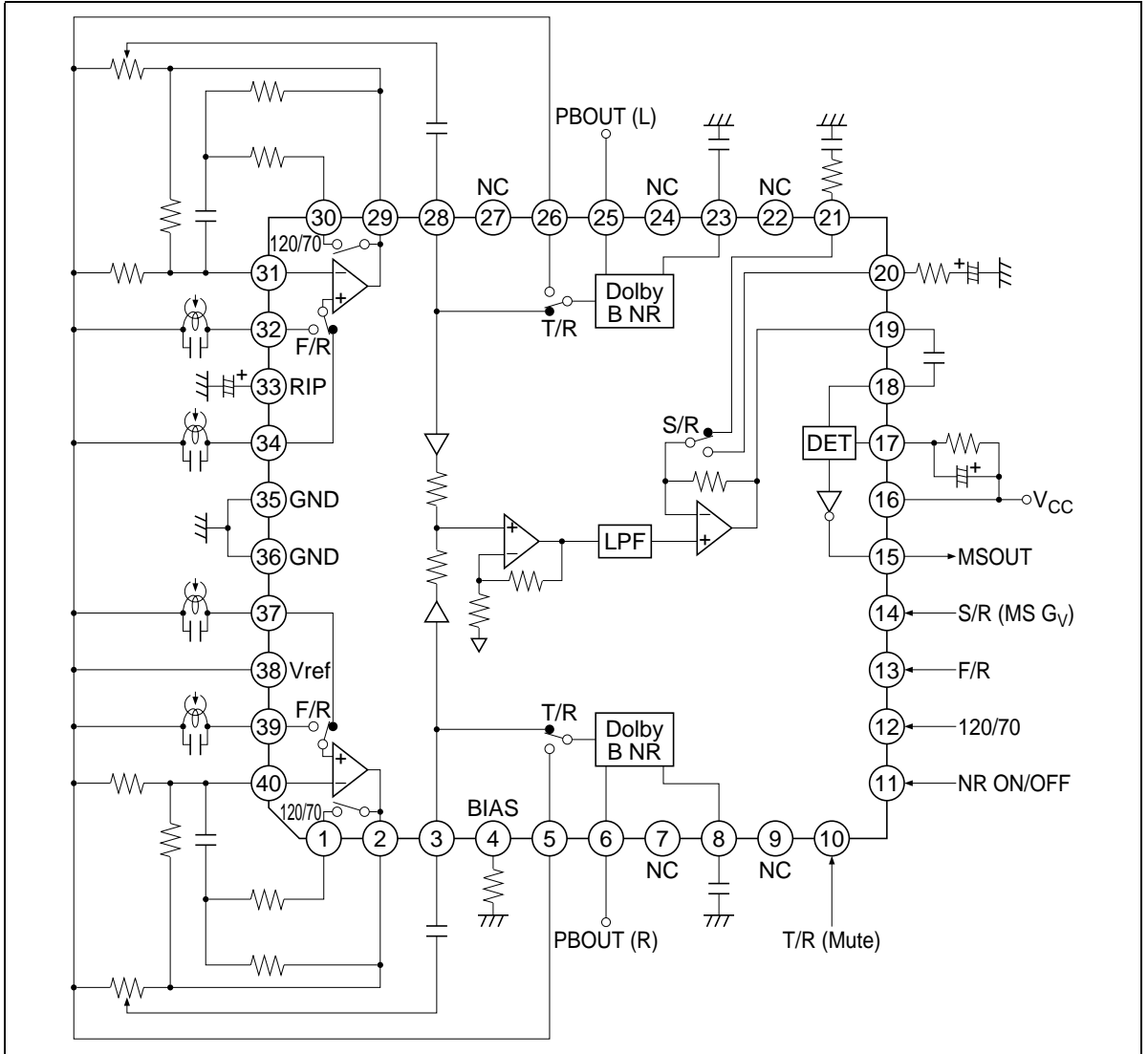

HA12221F Series

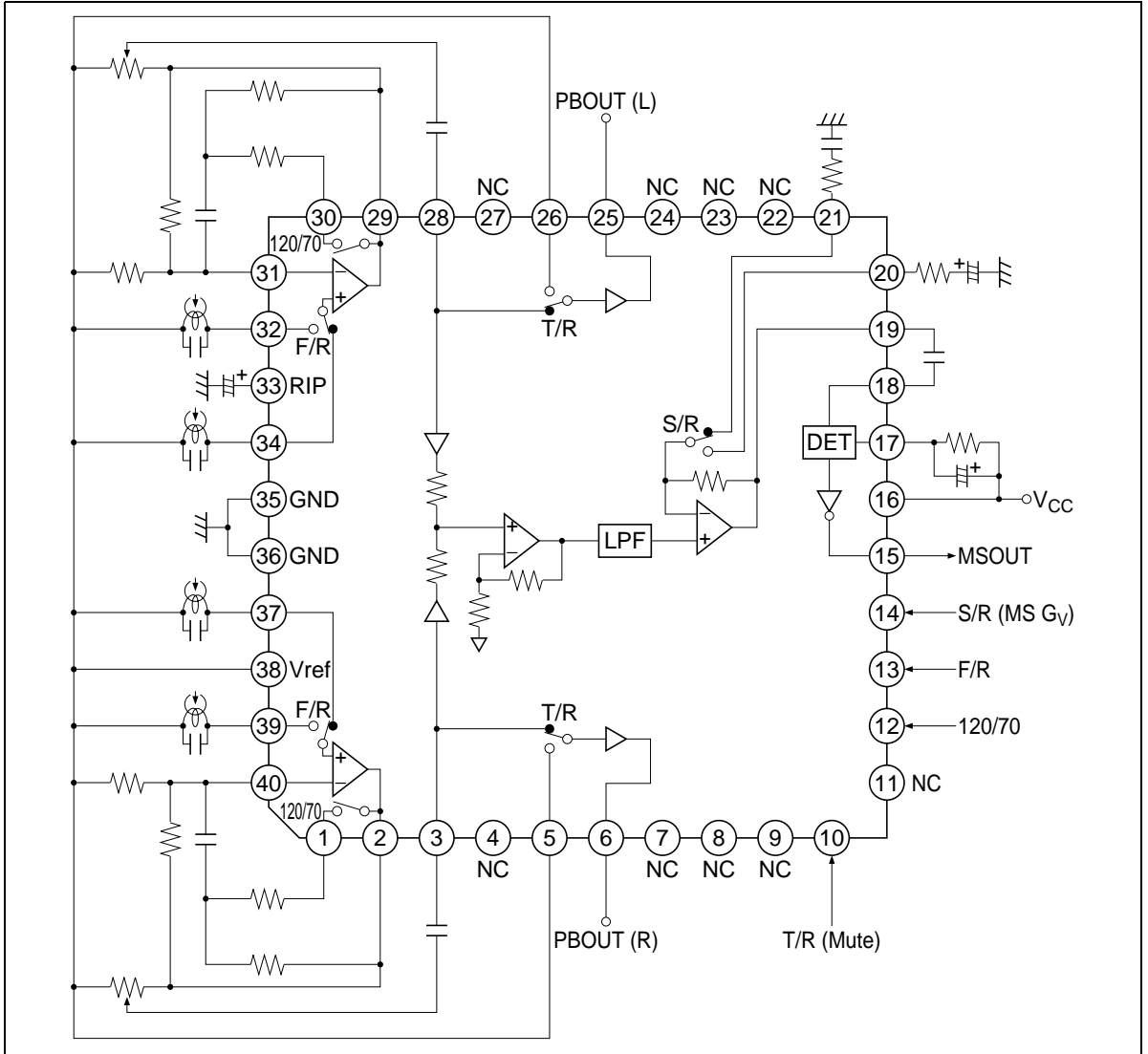

HA12216F/HA12221F Series

Functional Description

Power Supply Range

HA12216F/HA12221F series are provided with three line output level, which will permit on optimum overload margin for power supply conditions. And these are designed to operate on single supply only.

Table 1 Supply Voltage Range

Product	Single Supply
HA12216F/HA12221F	6.5 V to 12.0 V
HA12217F/HA12222F	6.8 V to 12.0 V
HA12218F/HA12223F	7.2 V to 12.0 V

Note: The lower limit of supply voltage depends on the line output reference level.
The minimum value of the overload margin is specified as 12 dB by Dolby Laboratories.

Reference Voltage

These devices provide the reference voltage of half the supply voltage that is the signal grounds. As the peculiarity of these devices, the capacitor for the ripple filter is very small about 1/100 compared with their usual value. The block diagram is shown as figure 1.

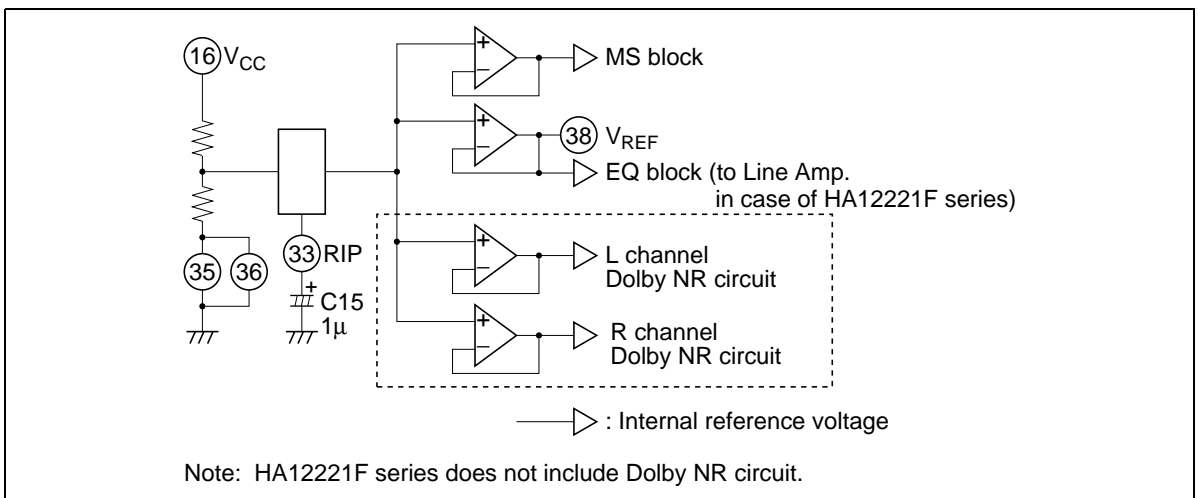

Figure 1 The Block Diagram of Reference Supply Voltage

Operating Mode Control

HA12216F/HA12221F series provides fully electronic switching circuits. And each operating mode control are controlled by parallel data (DC voltage).

When a power supply of this IC is cut off, for a voltage, in addition to a mode control terminal even though as do not destruct it, in series for resistance.

Table 2 Threshold Voltage (V_{TH})

Pin No.	Lo	Hi	Unit	Test Condition
10, 11*, 12, 13, 14	-0.2 to 1.0	3.5 to V_{CC}	V	Input Pin Measure

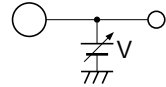

Note: * Non connection regarding HA12221F series.

Table 3 Switching Truth Table

Pin No.	Lo	Hi
10	TAPE	RADIO
11*	NR OFF	NR ON
12	120 μ (Normal)	70 μ (Metal or Chrome)
13	FORWARD	REVERSE
14	SER (FF or REV)	REP (Normal Speed)

Notes: * Non connection regarding HA12221F series.

1. Each pins are on pulled down with 100 k Ω internal resistor. Therefore, it will be low-level when each pins are open.
2. Over shoot level and under shoot level of input signal must be the standardized. (High: V_{CC} , Low: -0.2 V)
3. Reducing pop noise is so much better for 10 k Ω to 22 k Ω resistor and 1 μ F to 22 μ F capacitor shown figure 2.

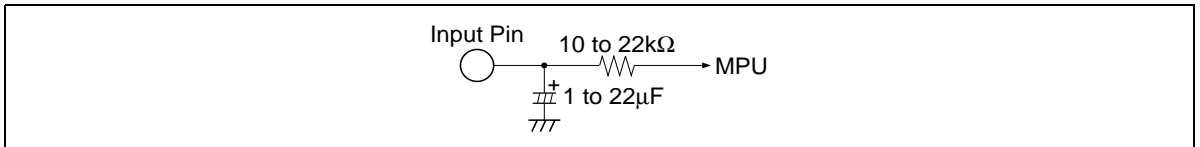

Figure 2 Interface for Reduction of Pop Noise

HA12216F/HA12221F Series

Input Block Diagram and Level Diagram

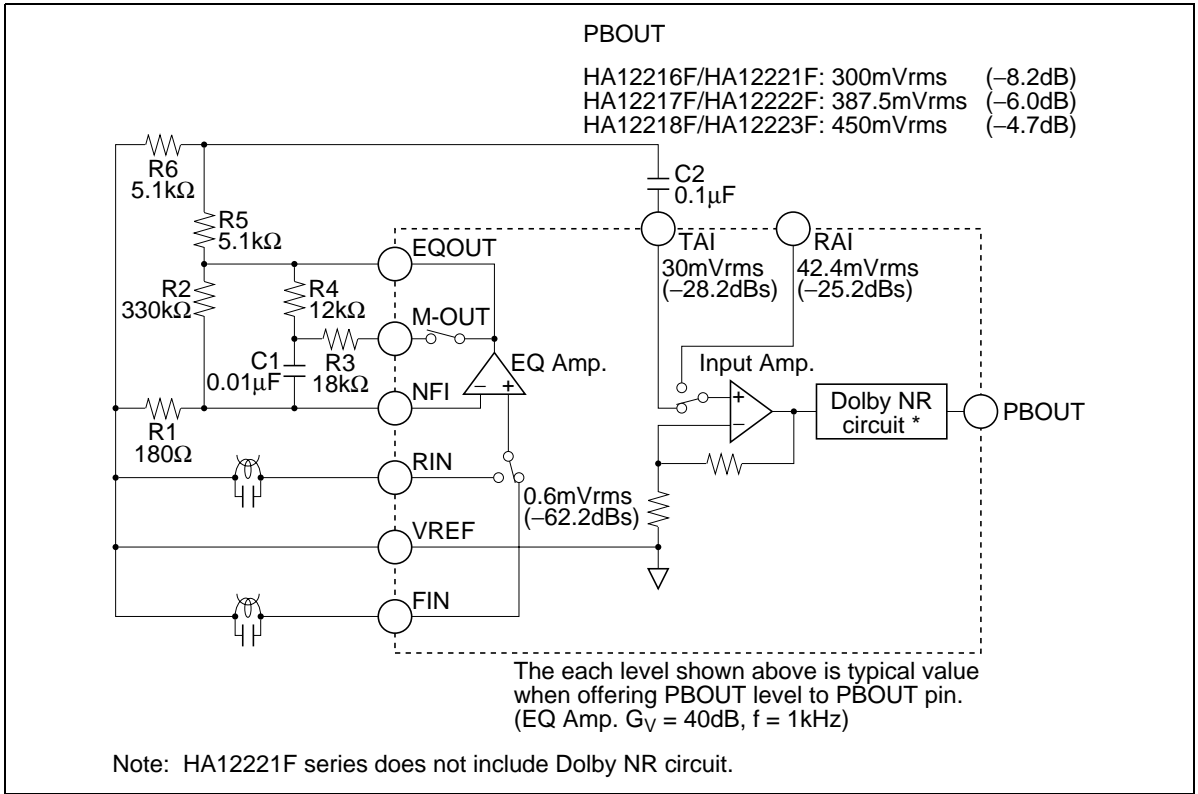

Figure 3 Input Block Diagram

Adjustment of Playback Reference Operate Level

After replace R5 and R6 with a half-fix volume of 10 kΩ, adjust playback reference operate level.

The Sensitivity Adjustment of Music Sensor

Adjusting MS Amp. gain by external resistor, the sensitivity of music sensor can set up. The music sensor block diagram is shown in figure 4, and frequency response is shown in figure 5.

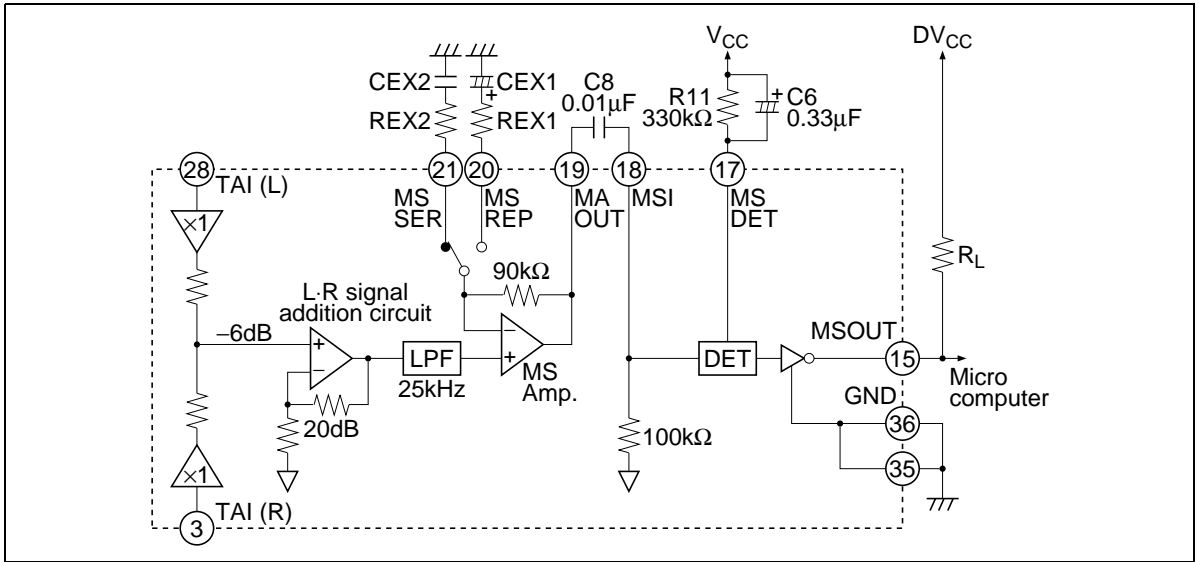

Figure 4 Music Sensor Block Diagram

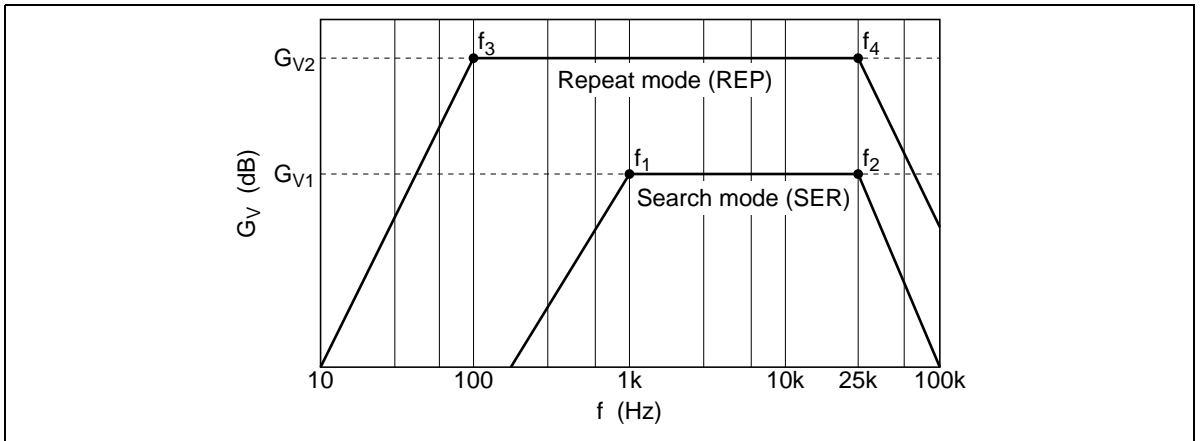

Figure 5 Frequency Response

HA12216F/HA12221F Series

1. Search mode

$$G_{V1} = 20\text{dB} + 20\log\left(1 + \frac{90\text{k}}{\text{REX2}}\right) \text{ [dB]}$$

$$f_1 = \frac{1}{2\pi \cdot \text{CEX2} \cdot \text{REX2}} \text{ [Hz]}, f_2 = 25\text{k} \text{ [Hz]}$$

2. Repeat mode

$$G_{V2} = 20\text{dB} + 20\log\left(1 + \frac{90\text{k}}{\text{REX1}}\right) \text{ [dB]}$$

$$f_3 = \frac{1}{2\pi \cdot \text{CEX1} \cdot \text{REX1}} \text{ [Hz]}, f_4 = 25\text{k} \text{ [Hz]}$$

G_{VIA} : L·R signal addition circuit gain.

The sensitivity of music sensor (S) is computed by the formula mentioned below.

$$S = -\left(G_V^{*1} - 20\log\frac{130^{*3}}{30^{*2}}\right) = 12.7 - G_V \text{ [dB]}$$

- Note:
1. Search mode: G_{V1} , Repeat mode: G_{V2}
 2. Standard level of TAI pin (Dolby level correspondence) = 30 mVrms
 3. Standard sensing level of music sensor = 130 mVrms

Item	REX1, 2	CEX1, 2	$G_{V1,2}$	$f_{1,3}$	$f_{2,4}$	S (one side channel)	S (both channel)
Search mode	24 k Ω	0.01 μ F	33.5 dB	663 Hz	25 kHz	-14.8 dB	-20.8 dB
Repeat mode	2.4 k Ω	1 μ F	51.7 dB	66.3 Hz	25 kHz	-33.0 dB	-39.0 dB

Note: S is 6 dB down in case of one-side channel. And this MS presented hysteresis lest MSOUT terminal should turn over again Hi level or Lo level, in case of thresh S level constantly.

Music Sensor Time Constant

1. Sensing no signal to signal (Attack) is determined by C6, 0.01 μ F to 1 μ F capacitor C6 can be applicable.
2. Sensing signal to no signal (Recovery) is determined by C6 and R11, however preceding (1), 100 k Ω to 1 M Ω can be applicable.

Music Sensor Output (MSOUT)

As for the internal circuit of music sensor block, music sensor output pin is connected to the collector of NPN type directly, therefore, output level will be “high” when sensing no signal. And output level will be “low” when sensing signal.

$$I_L = \frac{DV_{CC} - \text{MSOUT}_{LO}^*}{R_L}$$

* MSOUT_{LO} : Sensing signal (about 1V)

Note: 1. Supply voltage of MSOUT pin must be less than V_{CC} voltage.

The Tolerances of External Components for Dolby NR (Only HA12216F Series)

For adequate Dolby NR tracking response, take external components shown below.
Also, leak is small capacity, and please employ a good quality object.

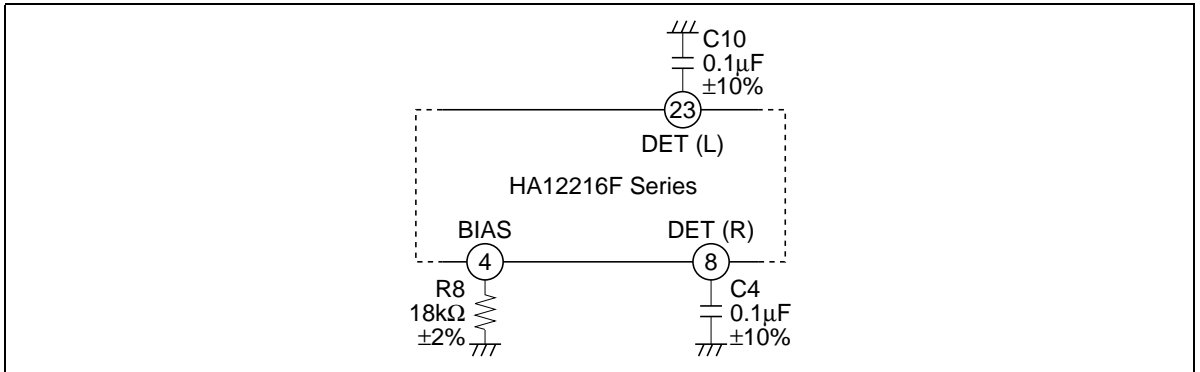

Figure 6 Tolerance of External Components

Countermeasure of a Cellular Phone Noise

This IC have reinforced a cellular phone noise countermeasure, to show it hereinafter.

However, it is presumed that this effect change it greatly, by a mount set.

Please sufficiently examine an arrangement of positions, shield method, wiring pattern, in order to obtain a maximum effect.

A high terminal of a noise sensitivity of this IC is FIN, RIN, NFI and RIP.

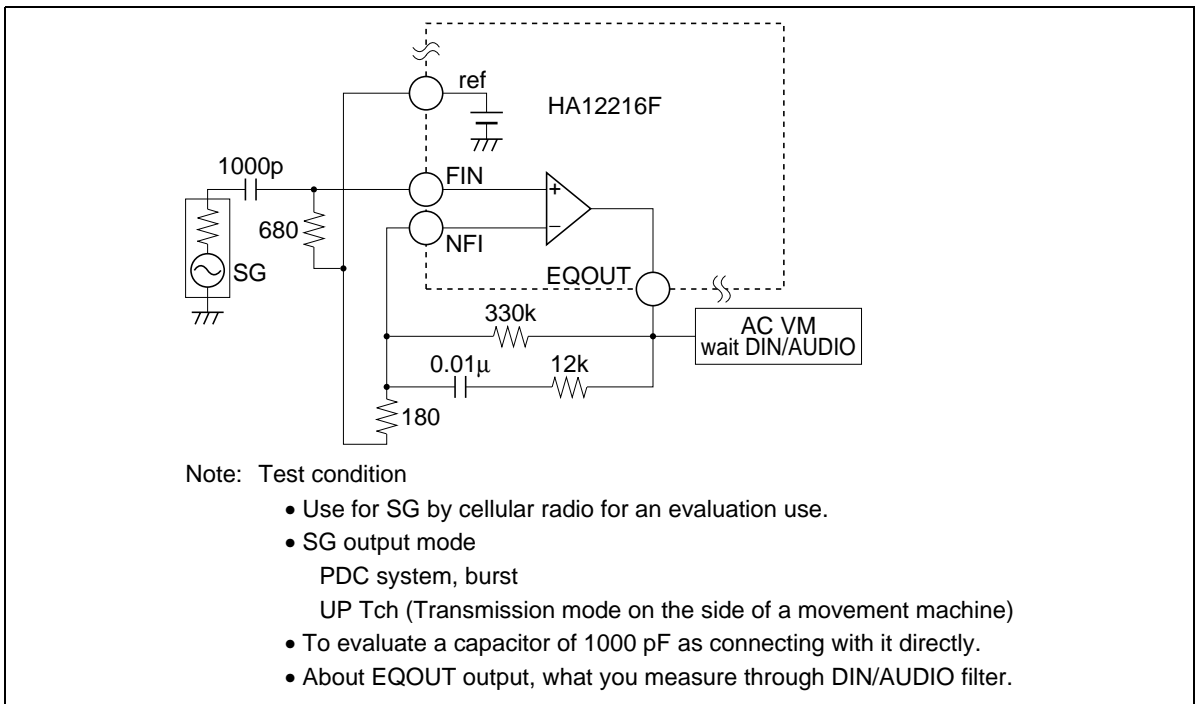

Figure 7 Test Circuit

HA12216F/HA12221F Series

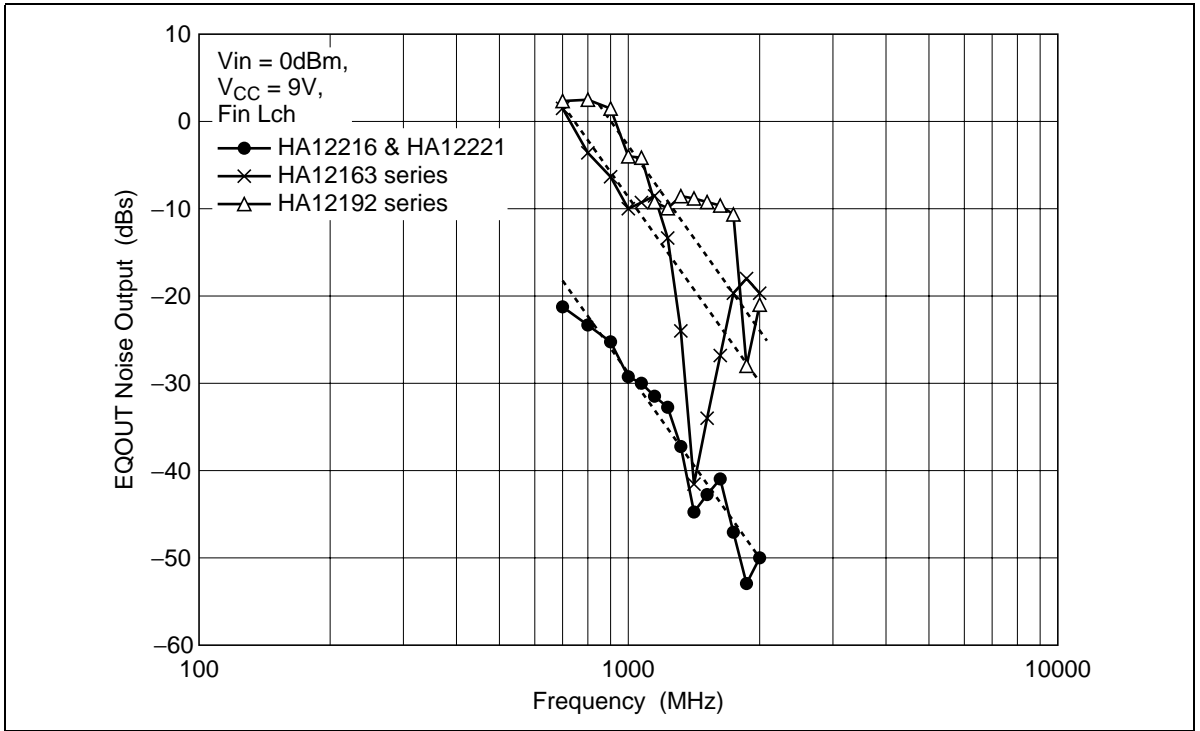

Figure 8 EQOUT Noise Output vs. Transmission Frequency Characteristic

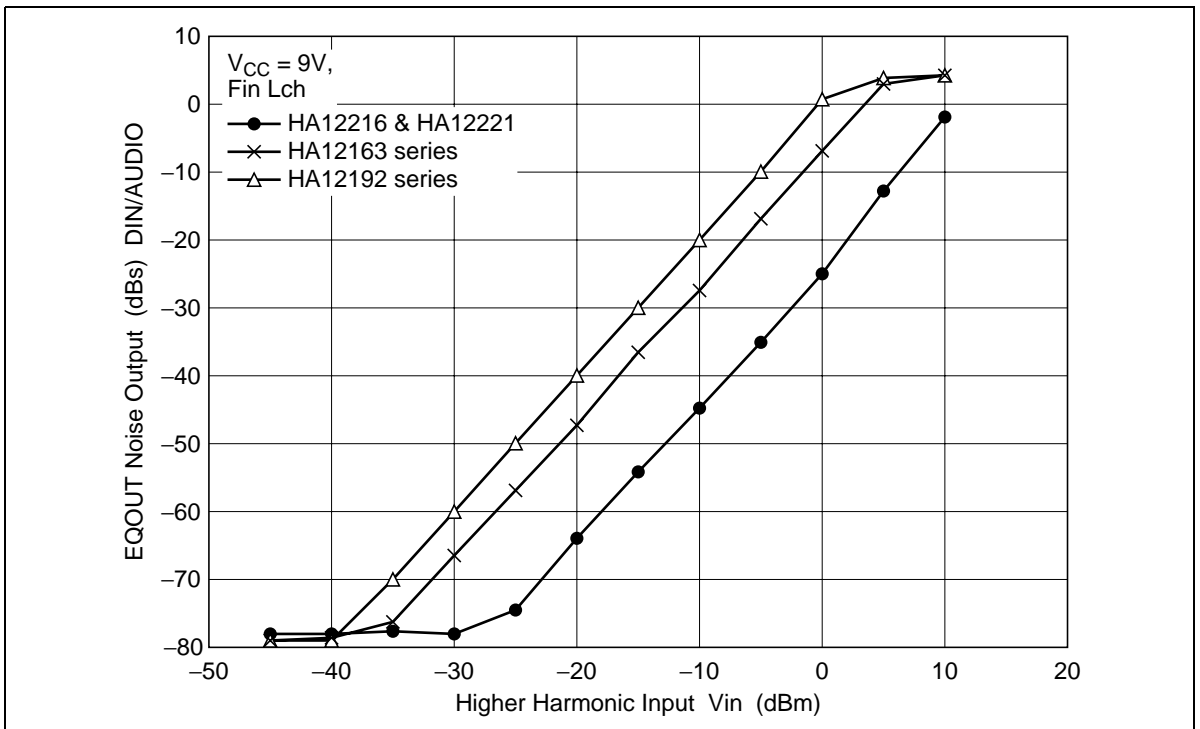

Figure 9 EQOUT Noise Output vs. Transmission

Absolute Maximum Ratings (Ta = 25°C)

Item	Symbol	Rating	Unit	Note
Maximum supply voltage	V _{cc} Max	16	V	
Power dissipation	Pd	400	mW	Ta ≤ 85°C
Operating temperature	Topr	-40 to +85	°C	
Storage temperature	Tstg	-55 to +125	°C	

HA12216F/HA12221F Series

Electrical Characteristics

HA12216F Series

(Ta = 25°C, V_{CC} = 9.0 V, PBOULT Level 300 mVrms(HA12216F) 387.5 mVrms(HA12217F) 450 mVrms(HA12218F))

Item	Symbol	Test Condition										Min	Typ	Max	Unit	Application Terminal						Remark
		IC Condition					IC Condition									Input		Output				
		NR ON/OFF	120μ/70μ	F/R	T/R	S/R	F	T	S	Input	Output					fin (Hz)	PBOULT level (dB)	R	L	R	L	
Quiescent current	I _Q	ON	—	—	—	—	—	—	—	—	—	—	4.0	9.5	15.0	mA	—	—	—	—	16	
Input Amp. gain	HA12216F	OFF	—	—	T	—	TAI	PBOULT	1k	0	—	18.8	19.8	20.8	dB	3	28	6	25			
		OFF	—	—	R	—	RAI	PBOULT	1k	0	—	15.8	16.8	17.8		5	26					
	HA12217F	OFF	—	—	T	—	TAI	PBOULT	1k	0	—	21.2	22.2	23.2		3	28					
		OFF	—	—	R	—	RAI	PBOULT	1k	0	—	18.2	19.2	20.2		5	26					
	HA12218F	OFF	—	—	T	—	TAI	PBOULT	1k	0	—	22.5	23.5	24.5		3	28					
		OFF	—	—	R	—	RAI	PBOULT	1k	0	—	19.5	20.5	21.5		5	26					
B-type decode cut	DEC-2k (1)	ON	—	—	T	—	TAI	PBOULT	2k	-20	—	2.8	4.3	5.8	dB	3	28	6	25			
	DEC-2k (2)	ON	—	—	T	—	TAI	PBOULT	2k	-30	—	7.0	8.5	10.0								
	DEC-5k (1)	ON	—	—	T	—	TAI	PBOULT	5k	-20	—	1.7	3.2	4.7								
	DEC-5k (2)	ON	—	—	T	—	TAI	PBOULT	5k	-30	—	6.7	8.2	9.7								
PBOULT offset	VoIs	OFF	—	—	T↔R	—	—	PBOULT	—	—	—	V _{CC} =12V, No signal	-150	0.0	150	mV	3	28	6	25		
Signal handling	Vo max	ON	—	—	T	—	TAI	PBOULT	1k	—	—	THD=1%	12.0	13.0	—	dB	3	28	6	25	1	
Signal to noise ratio	S/N	ON	—	—	T	—	TAI	PBOULT (1k)	(0)	(0)	—	Rg=10kΩ, CCIR/ARM	70.0	80.0	—	dB	(3)	(28)	6	25		
T.H.D.	THD	ON	—	—	T	—	TAI	PBOULT	1k	0	—	—	0.05	0.3	%	3	28	6	25			
Channel separation	CT RL (1)	OFF	—	—	R	—	RAI	PBOULT	1k	(+12)	—	70.0	80.0	—	dB	3	28	6→25	25→6			
	CT RL (2)	OFF	120μ	F	T	—	FIN	PBOULT	1k	(+12)	—	50.0	60.0	—		37	34					
Crosstalk	CT EQ→RAI	OFF	120μ	F	T→R	—	FIN	PBOULT	1k	(+12)	—	70.0	80.0	—	dB	37	34	6	25			
	CT RAI→EQ	OFF	120μ	F	R→T	—	RAI	PBOULT	1k	(+12)	—	50.0	60.0	—		5	26					
PB-EQ gain	G _P EQ 1k	—	120μ	F/R	—	—	FIN/RIN	EQOUT	1k	—	—	Vin=0.6mVrms	37.0	40.0	43.0	dB	37/39	34/32	2	29		
	G _V EQ 10k(1)	—	120μ	F	—	—	FIN	EQOUT	10k	—	—	33.0	36.0	39.0		37	34					
	G _V EQ 10k(2)	—	70μ	F	—	—	FIN	EQOUT	10k	—	—	29.0	32.0	35.0		37	34					
PB-EQ Max output level	V _{GM}	—	120μ	F/R	—	—	FIN	EQOUT	1k	—	—	THD=1%	300	600	—	mVrms	37/39	34/32	2	29	1	
PB-EQ THD	THD-EQ	—	120μ	F/R	—	—	FIN/RIN	EQOUT	1k	—	—	Vin=3mVrms	—	0.1	0.3	%	37/39	34/32	2	29		
Noise level converted in input	V _N	—	120μ	F/R	—	—	FIN/RIN	EQOUT (1k)	—	—	—	Rg=680Ω, DIN-AUDIO	—	0.7	1.5	μVrms	(37/39)	(34/32)	2	29		
MS sensitivity level	V _{ON} (1)	—	—	—	T	R	TAI	PBOULT	5k	—	—	—	-36	-32	-28	dB	3	28	2	29	15	
	V _{ON} (2)	—	—	—	T	S	TAI	PBOULT	5k	—	—	—	-18	-14	-10							
MS output low level	V _{OL}	—	—	—	T	S	TAI	MSOUT	5k	0	—	—	—	1.0	1.5	V	3	28	—	—	15	
MS output leak current	I _{OH}	—	—	—	—	—	—	MSOUT	—	—	—	No signal	—	0.0	2.0	μA	—	—	—	—	15	
Control voltage	V _{IL}	—	—	—	—	—	—	—	—	—	—	—	-0.2	—	1.0	V	—	—	—	—	10 to 14	
	V _{IH}	—	—	—	—	—	—	—	—	—	—	—	3.5	—	V _{CC}							

Note: 1. HA12216F: V_{CC} = 6.5V
 HA12217F: V_{CC} = 6.8V
 HA12218F: V_{CC} = 7.2V

HA12221F Series

(Ta = 25°C, V_{CC} = 9.0 V, PBOUT Level 300 mVrms(HA12221F) 387.5 mVrms(HA12222F) 450 mVrms(HA12223F))

Item	Symbol	Test Condition										Application Terminal										Remark								
		IC Condition					Test Condition					Input					Output													
		120μ/70μ	F/R	T/R	S/R	T/S	Input	Output	f _{in} (Hz)	PBOUT level (dB)	Min	Typ	Max	Unit	R	L	R	L	R	L										
Quiescent current	I _Q	70μ	F	T	S	—	—	—	—	—	No signal	—	—	3.0	5.0	8.0	mA	—	—	—	—	—	—	—	—	—	—	—	16	
Input Amp. gain	G _V /A TAI	—	—	T	—	TAI	PBOUT	1k	0	—	—	—	—	19.0	20.0	21.0	dB	3	28	6	25	—	—	—	—	—	—	—	—	
	G _V /A RAI	—	—	R	—	RAI	PBOUT	1k	0	—	—	—	—	16.0	17.0	18.0	—	5	26	—	—	—	—	—	—	—	—	—	—	
	G _V /A TAI	—	—	T	—	TAI	PBOUT	1k	0	—	—	—	—	21.2	22.2	23.2	—	3	28	—	—	—	—	—	—	—	—	—	—	
	G _V /A RAI	—	—	R	—	RAI	PBOUT	1k	0	—	—	—	—	18.2	19.2	20.2	—	5	26	—	—	—	—	—	—	—	—	—	—	—
	G _V /A TAI	—	—	T	—	TAI	PBOUT	1k	0	—	—	—	—	22.5	23.5	24.5	—	3	28	—	—	—	—	—	—	—	—	—	—	—
	G _V /A RAI	—	—	R	—	RAI	PBOUT	1k	0	—	—	—	—	19.5	20.5	21.5	—	5	26	—	—	—	—	—	—	—	—	—	—	—
PBOUT offset	V _{ofs}	—	—	T↔R	—	—	PBOUT	—	—	—	V _{CC} =12V, No signal	—	—	—15.0	0.0	15.0	mV	3	28	6	25	—	—	—	—	—	—	—	—	—
Signal handling	V _{o max}	—	—	T	—	TAI	PBOUT	1k	—	—	THD=1%	—	—	12.0	13.0	—	dB	3	28	6	25	—	—	—	—	—	—	—	—	1
Signal to noise ratio	S/N	—	—	T	—	TAI	PBOUT	(1k)	(0)	—	R _g =10kΩ, CCIR/ARM	—	—	70.0	80.0	—	dB	(3)	(28)	6	25	—	—	—	—	—	—	—	—	—
T.H.D.	THD	—	—	T	—	TAI	PBOUT	1k	0	—	—	—	—	—	0.05	0.3	%	3	28	6	25	—	—	—	—	—	—	—	—	—
Channel separation	CT RL (1)	—	—	R	—	RAI	PBOUT	1k	(+12)	—	—	—	—	70.0	80.0	—	dB	3	28	6	25	—	—	—	—	—	—	—	—	—
	CT RL (2)	—	—	F	—	FIN	PBOUT	1k	(+12)	—	—	—	—	50.0	60.0	—	—	37	34	—	—	—	—	—	—	—	—	—	—	—
Crosstalk	CT EQ→RAI	120μ	F	T→R	—	FIN	PBOUT	1k	(+12)	—	—	—	—	70.0	80.0	—	dB	37	34	6	25	—	—	—	—	—	—	—	—	—
	CT RAI→EQ	120μ	F	R→T	—	RAI	PBOUT	1k	(+12)	—	—	—	—	50.0	60.0	—	—	5	26	—	—	—	—	—	—	—	—	—	—	—
	G _V EQ 1k	120μ	F/R	—	—	FIN/RIN	EQOUT	1k	—	—	V _{in} =0.6mVrms	—	—	37.0	40.0	43.0	dB	37/39	34/32	2	29	—	—	—	—	—	—	—	—	—
PB-EQ gain	G _V EQ 10k(1)	120μ	F	—	—	FIN	EQOUT	10k	—	—	—	—	—	33.0	36.0	39.0	—	37	34	—	—	—	—	—	—	—	—	—	—	—
	G _V EQ 10k(2)	70μ	F	—	—	FIN	EQOUT	10k	—	—	—	—	—	29.0	32.0	35.0	—	37	34	—	—	—	—	—	—	—	—	—	—	—
PB-EQ Max output level	V _{OM}	120μ	F/R	—	—	FIN	EQOUT	1k	—	—	THD=1%	—	—	300	600	—	mVrms	37/39	34/32	2	29	—	—	—	—	—	—	—	—	—
PB-EQ THD	THD-EQ	120μ	F/R	—	—	FIN/RIN	EQOUT	1k	—	—	V _{in} =3mVrms	—	—	—	0.1	0.3	%	37/39	34/32	2	29	—	—	—	—	—	—	—	—	—
Noise level converted in input	V _N	120μ	F/R	—	—	FIN/RIN	EQOUT	(1k)	—	—	R _g =680Ω, DIN-AUDIO	—	—	—	0.7	1.5	μVrms	(37/39)	(34/32)	2	29	—	—	—	—	—	—	—	—	—
	V _{ON} (1)	—	—	T	R	TAI	PBOUT	5k	—	—	—	—	—	-36	-32	-28	dB	3	28	2	29	—	—	—	—	—	—	—	—	—
MS output low level	V _{OL}	—	—	T	S	TAI	PBOUT	5k	—	—	—	—	—	-18	-14	-10	—	—	—	—	—	—	—	—	—	—	—	—	—	—
	V _{OH}	—	—	T	S	TAI	MSOUT	5k	0	—	—	—	—	—	1.0	1.5	V	3	28	—	—	—	—	—	—	—	—	—	—	—
MS output leak current	I _{OH}	—	—	—	—	—	MSOUT	—	—	—	No signal	—	—	—	0.0	2.0	μA	—	—	—	—	—	—	—	—	—	—	—	—	—
Control voltage	V _{IL}	—	—	—	—	—	—	—	—	—	—	—	—	-0.2	—	—	V	—	—	—	—	—	—	—	—	—	—	—	—	—
	V _{IH}	—	—	—	—	—	—	—	—	—	—	—	—	3.5	—	—	V _{CC}	—	—	—	—	—	—	—	—	—	—	—	—	—

Note: 1. HA12221F: V_{CC} = 6.5V
 HA12222F: V_{CC} = 6.8V
 HA12223F: V_{CC} = 7.2V

HA12216F/HA12221F Series

Test Circuit

HA12216F Series

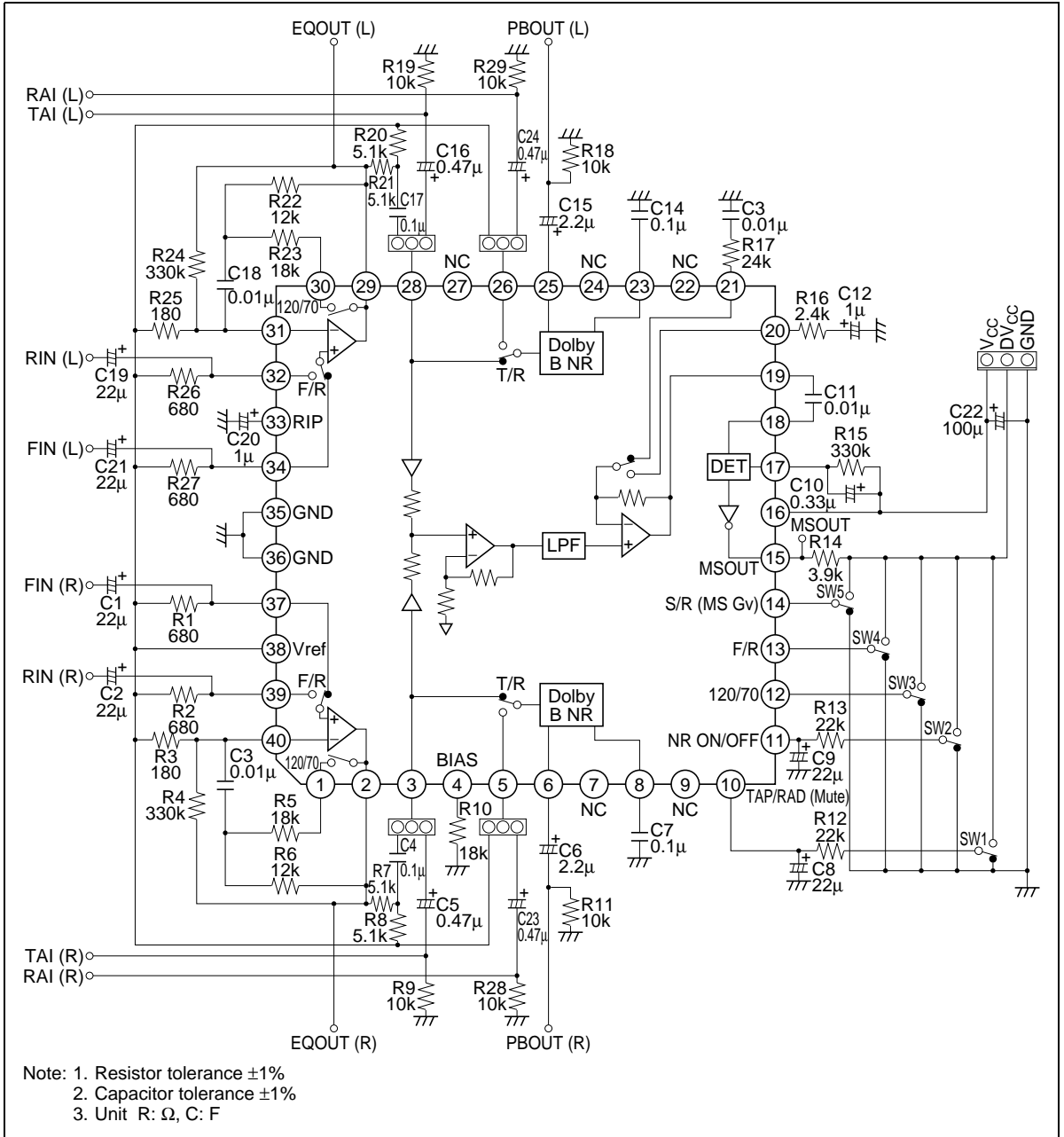

HA12221F Series

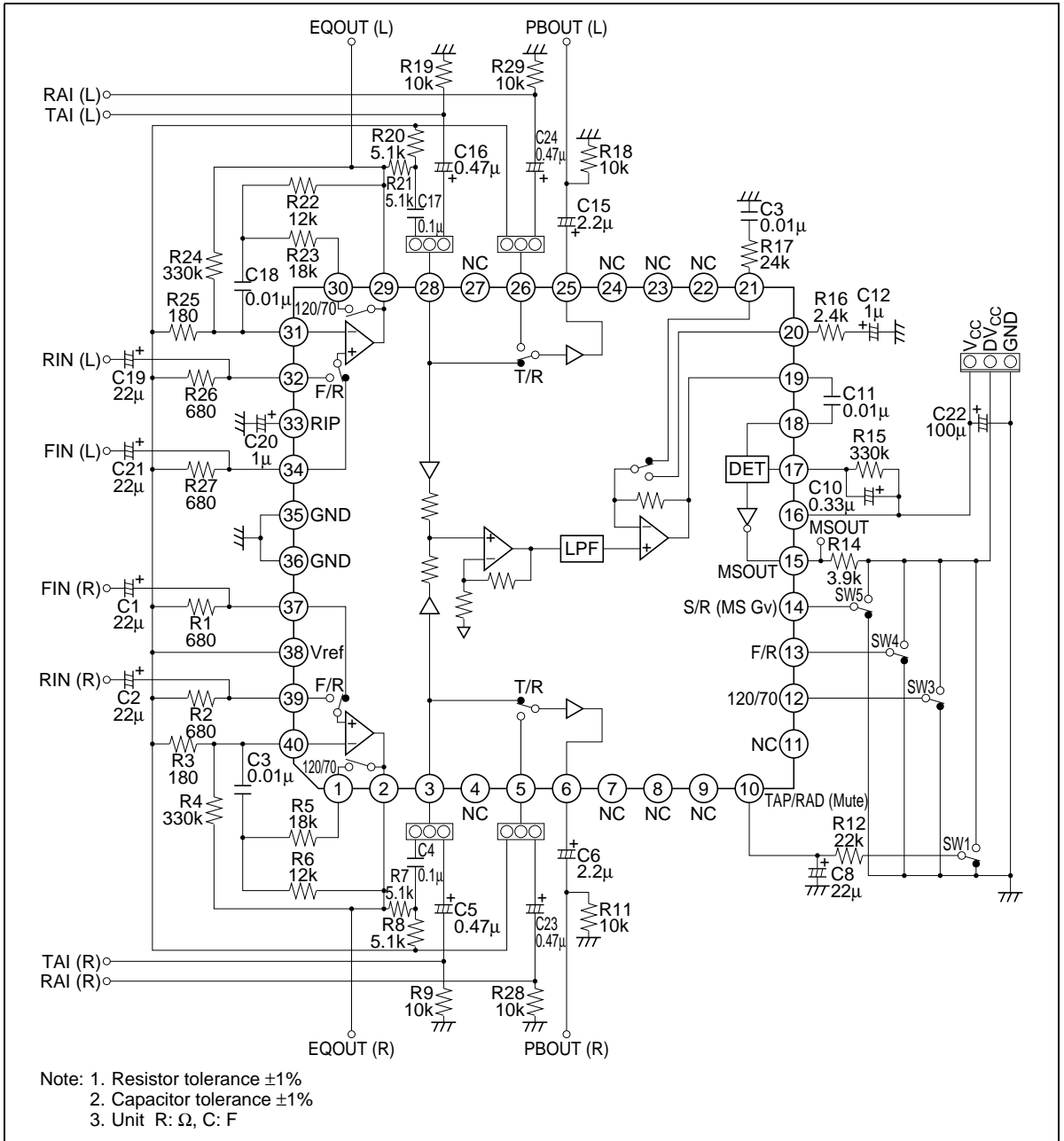

HA12216F/HA12221F Series

Characteristic Curves

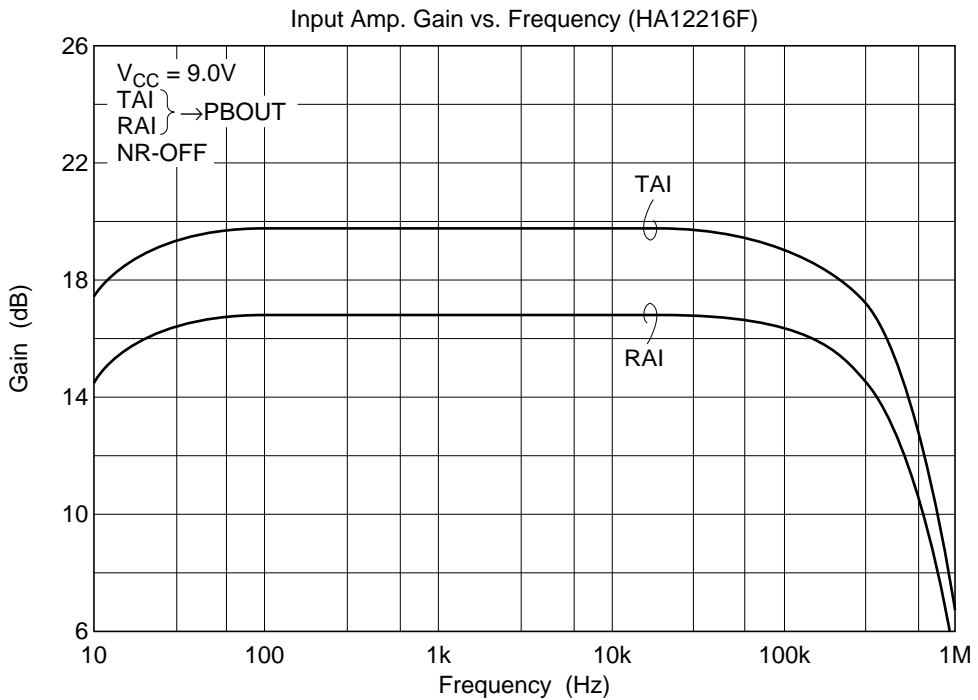
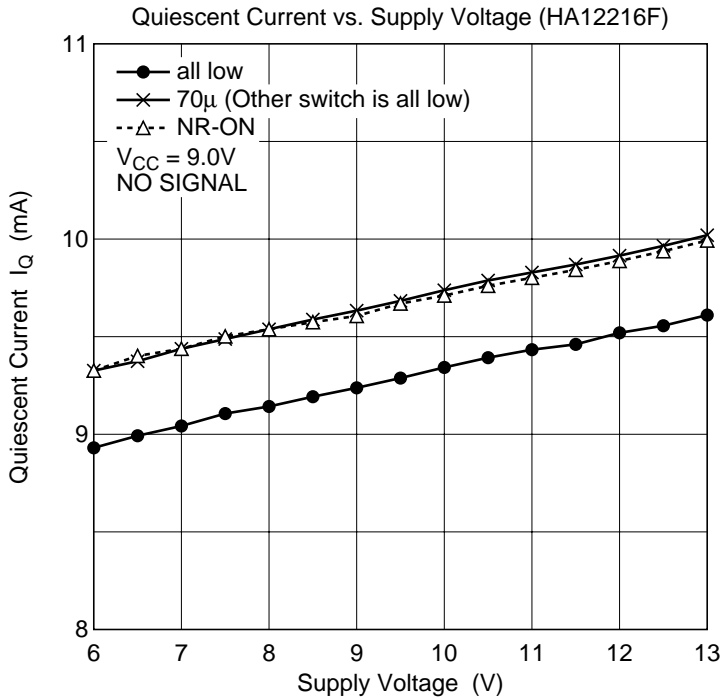

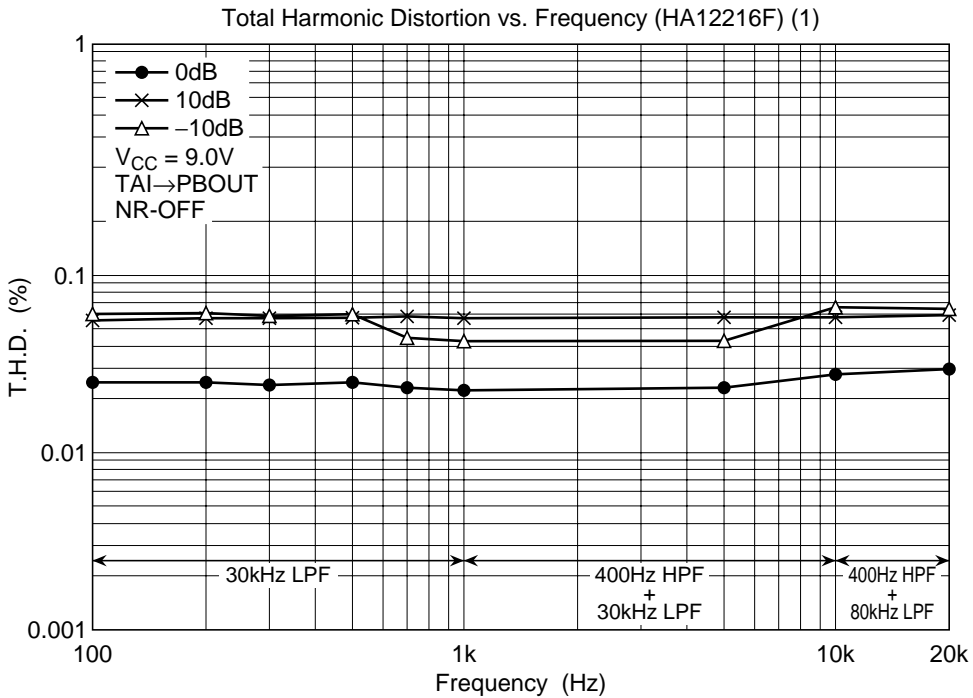
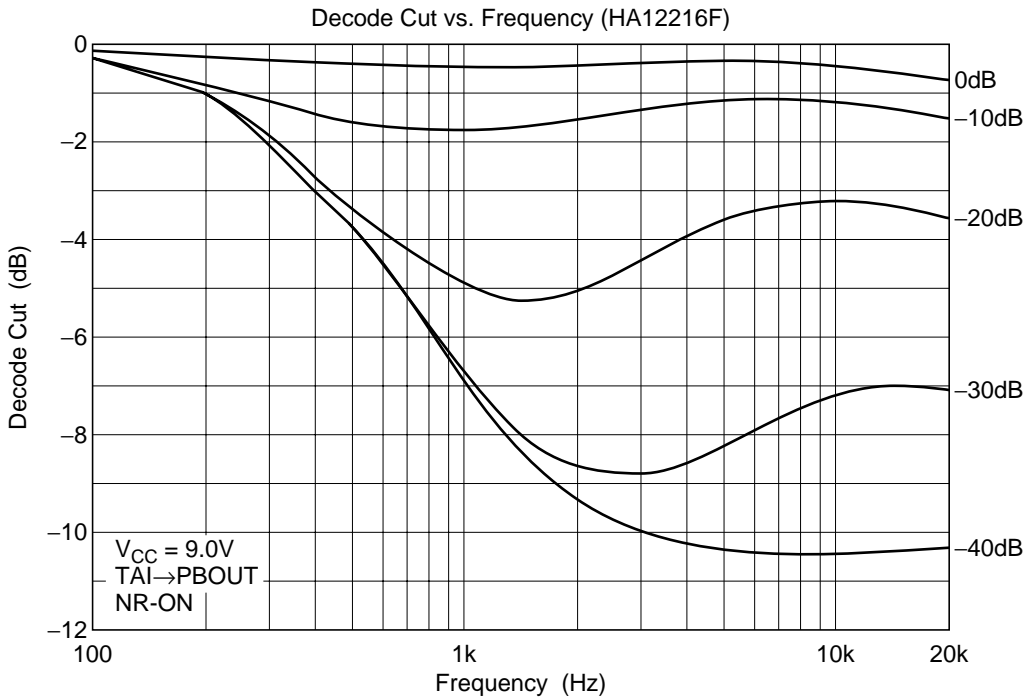

HA12216F/HA12221F Series

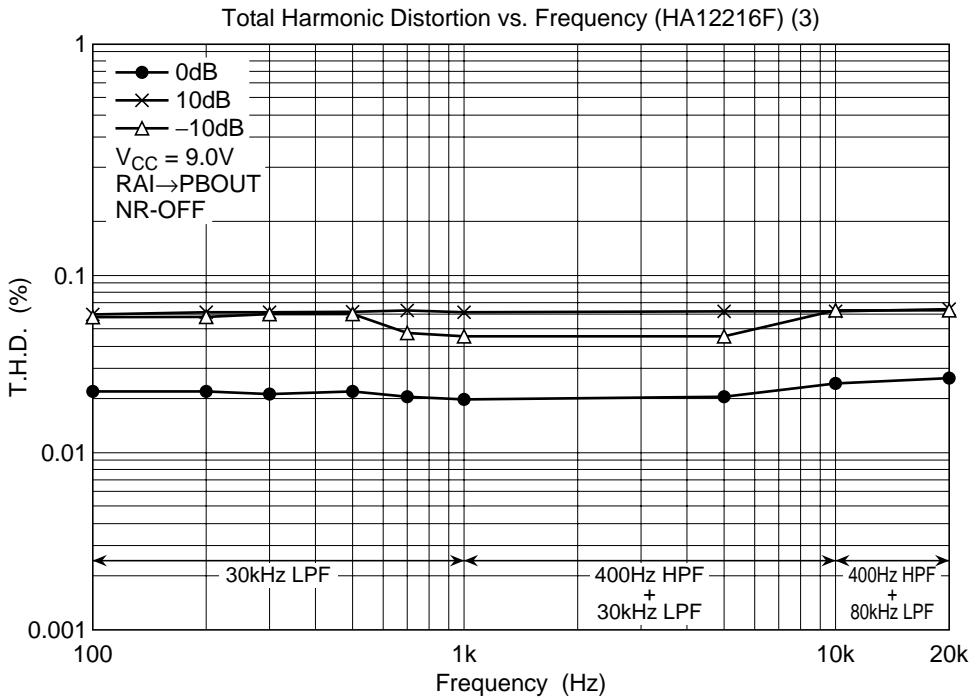
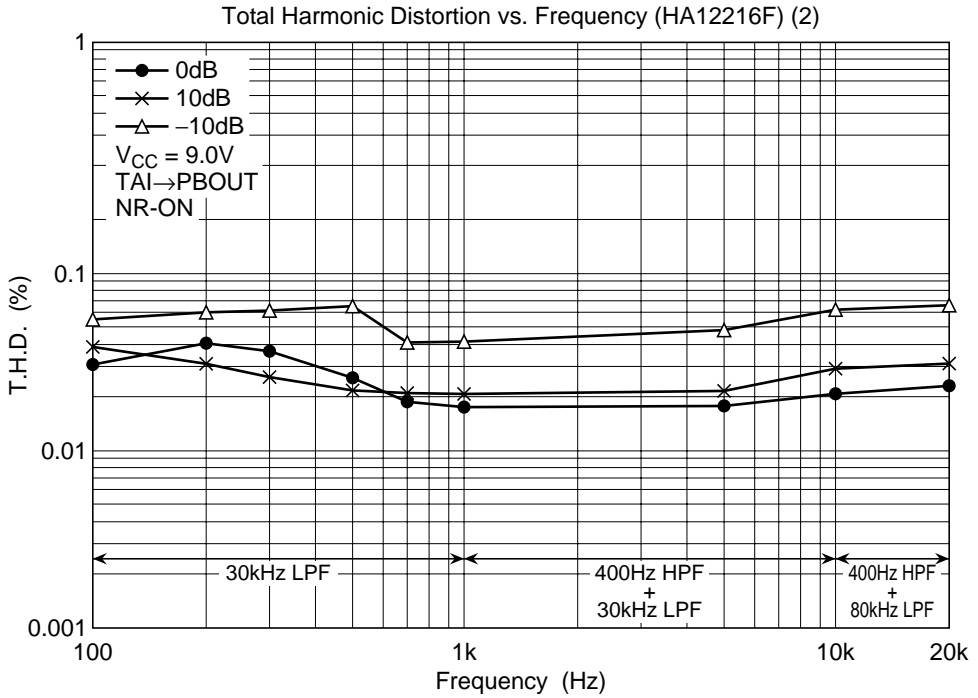

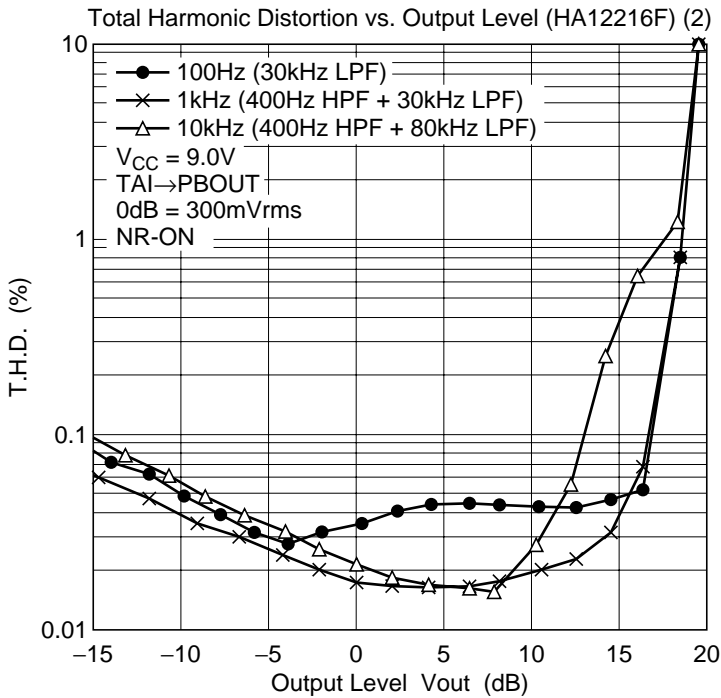
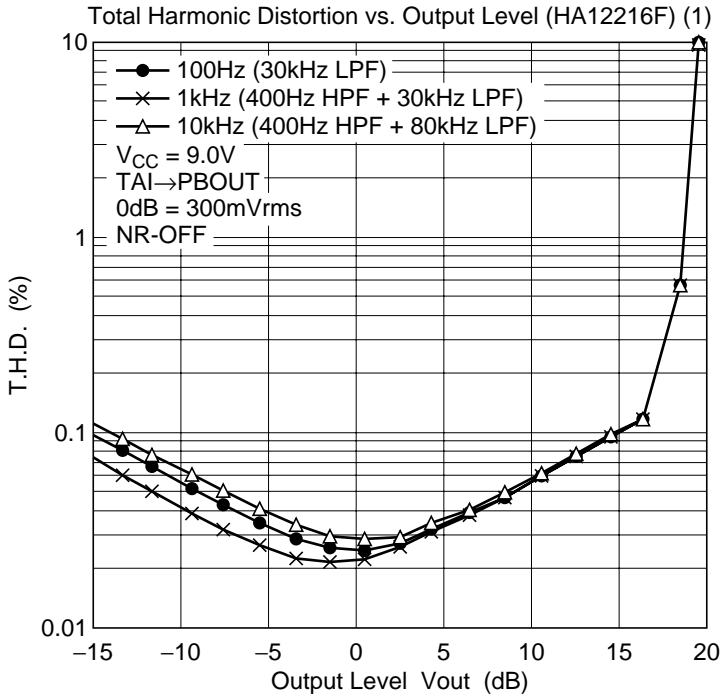

HA12216F/HA12221F Series

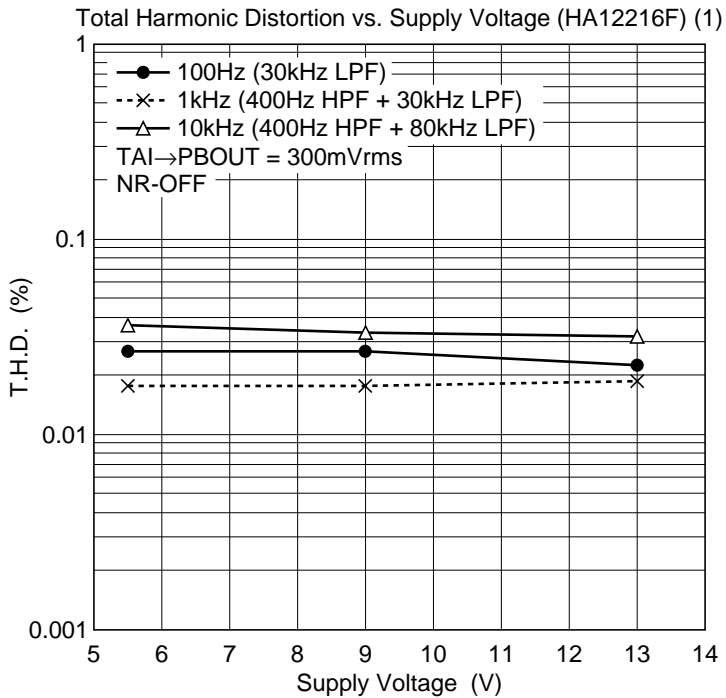
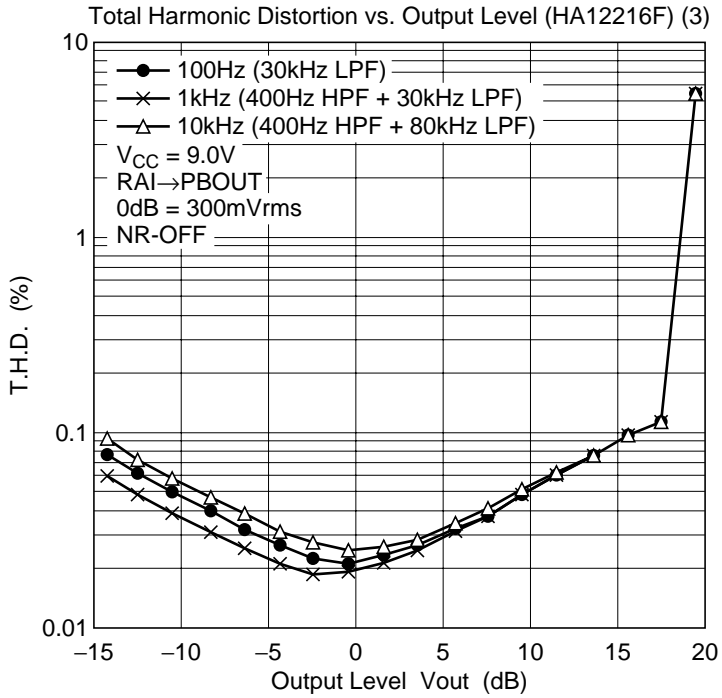

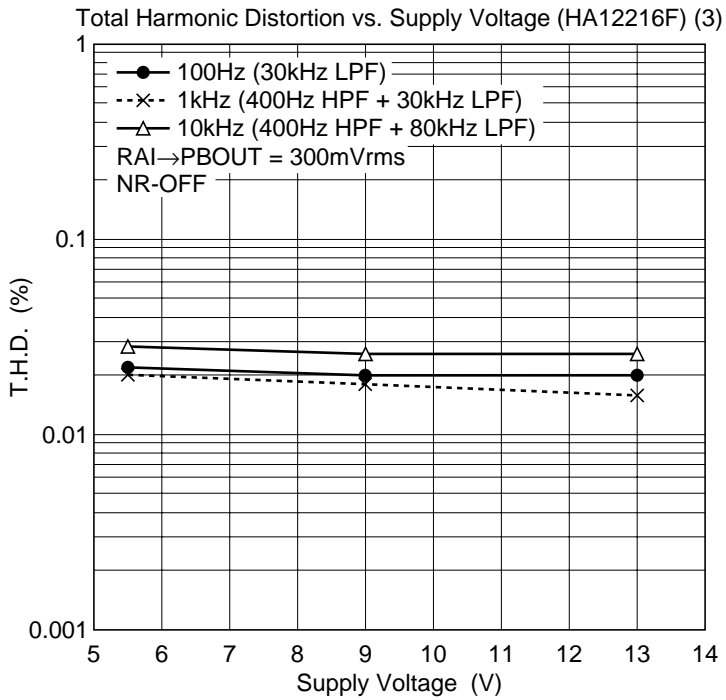
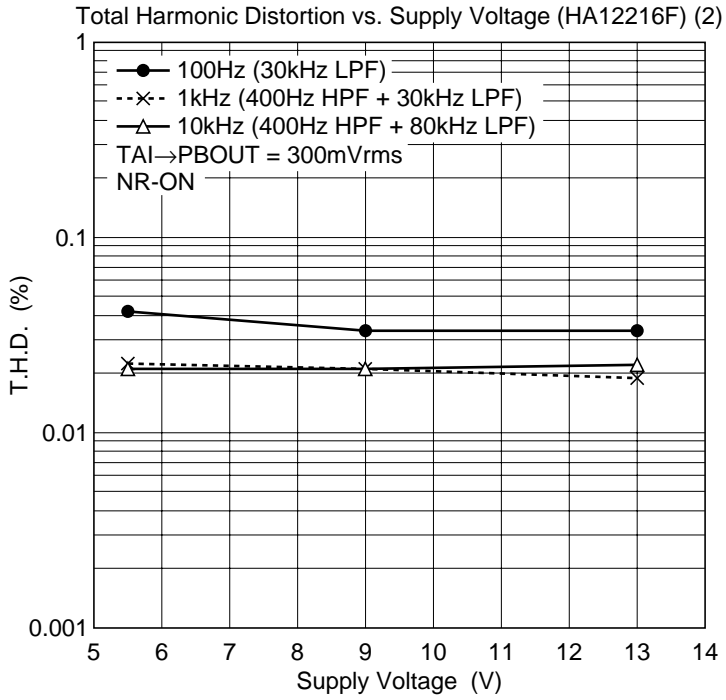

HA12216F/HA12221F Series

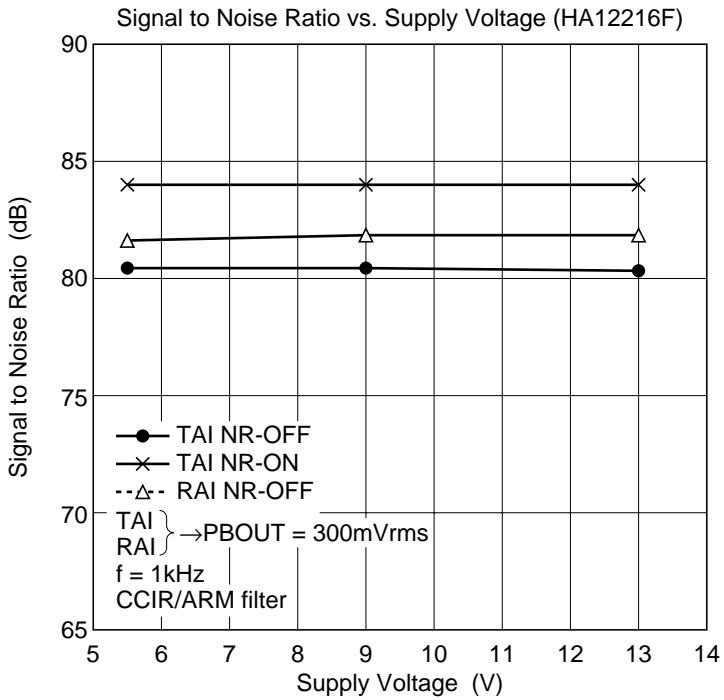
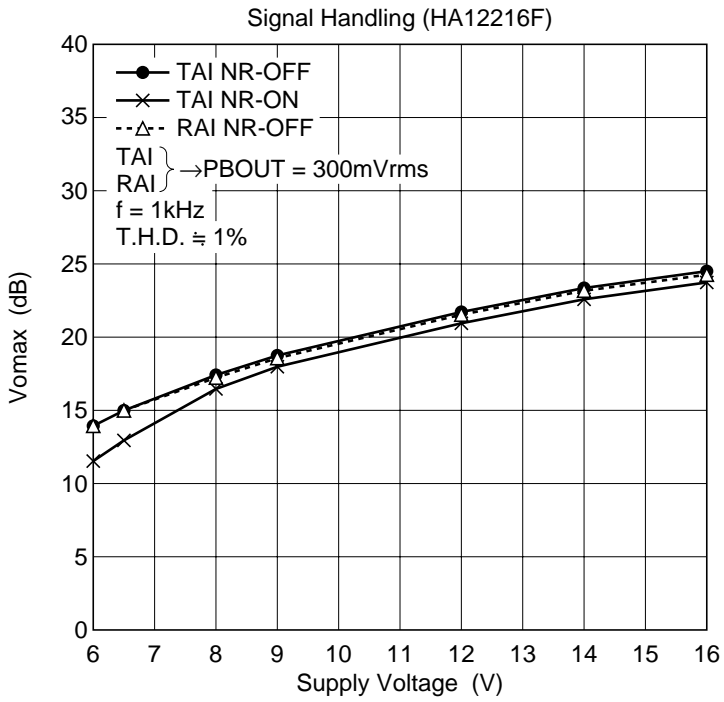

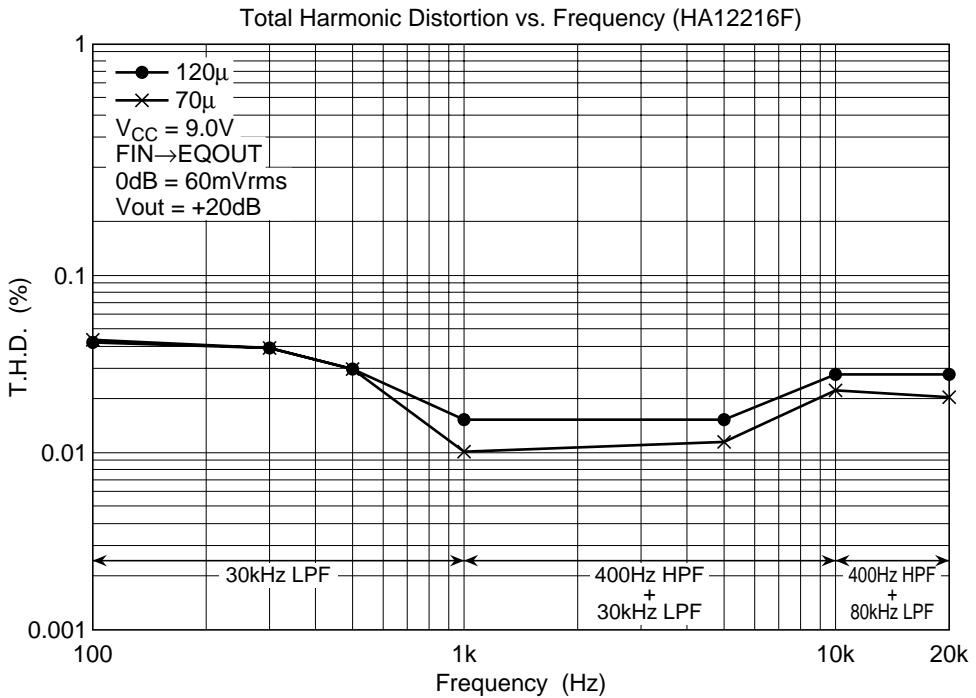
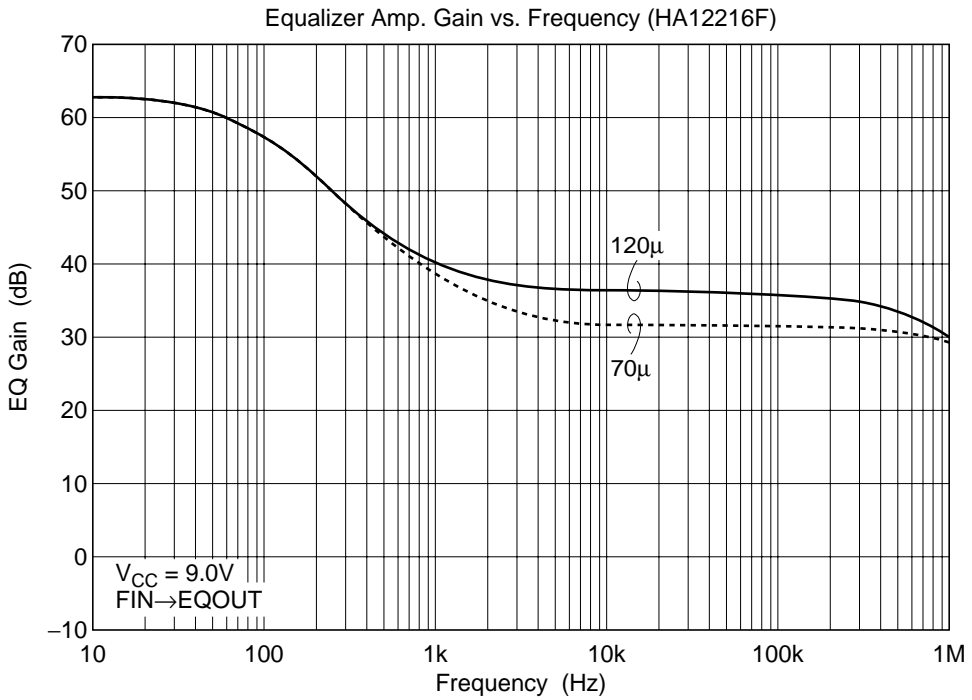

HA12216F/HA12221F Series

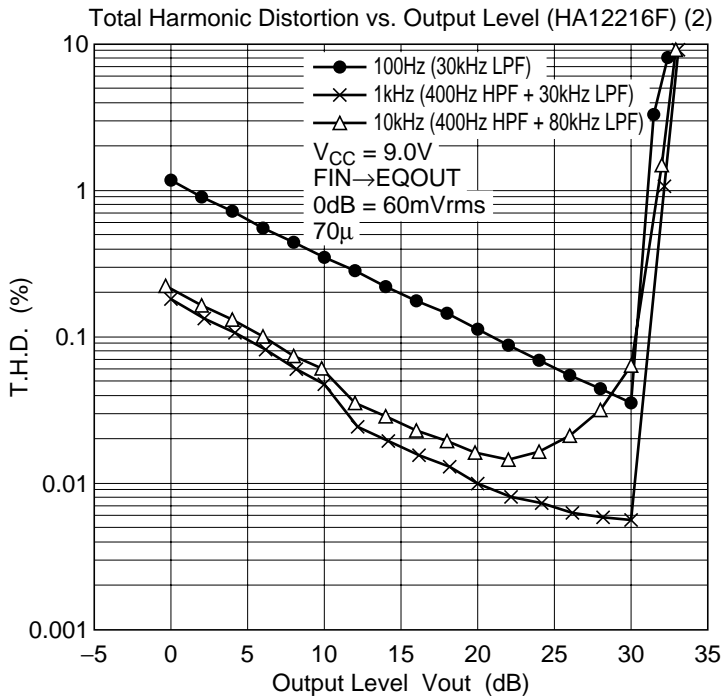
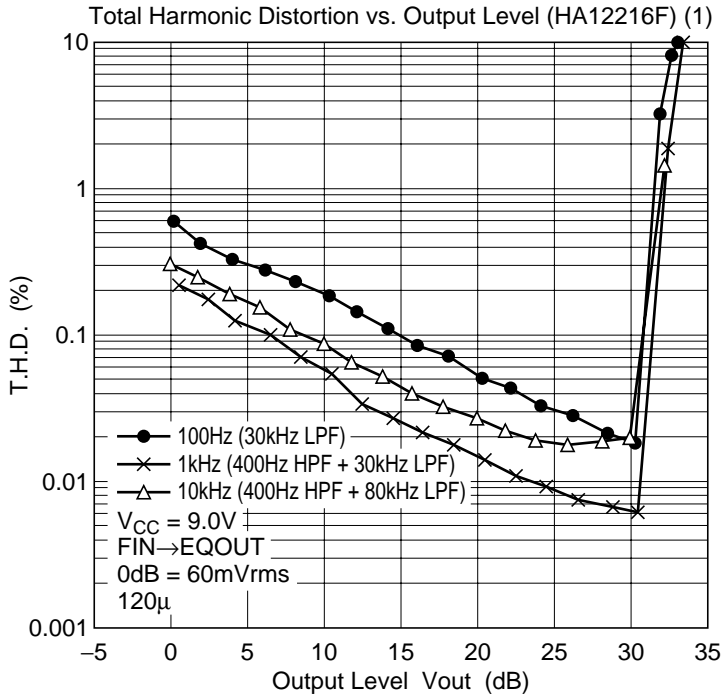

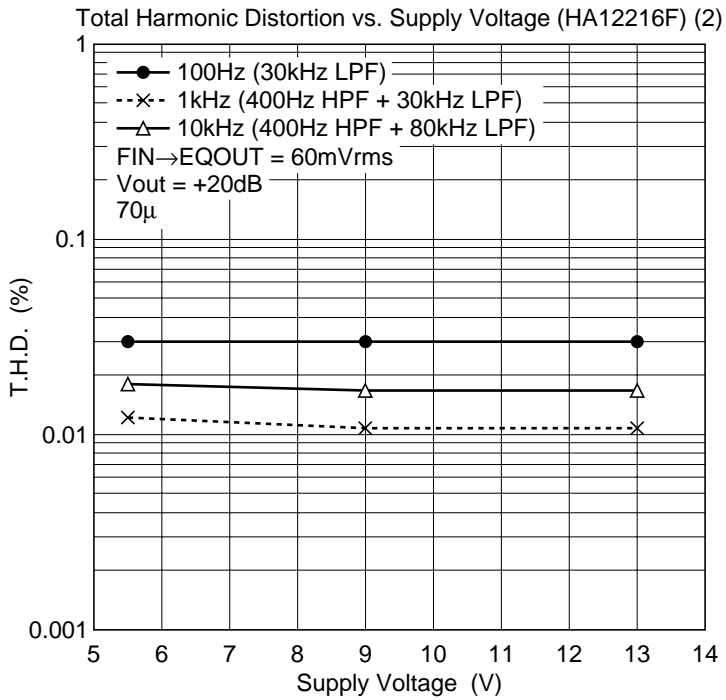
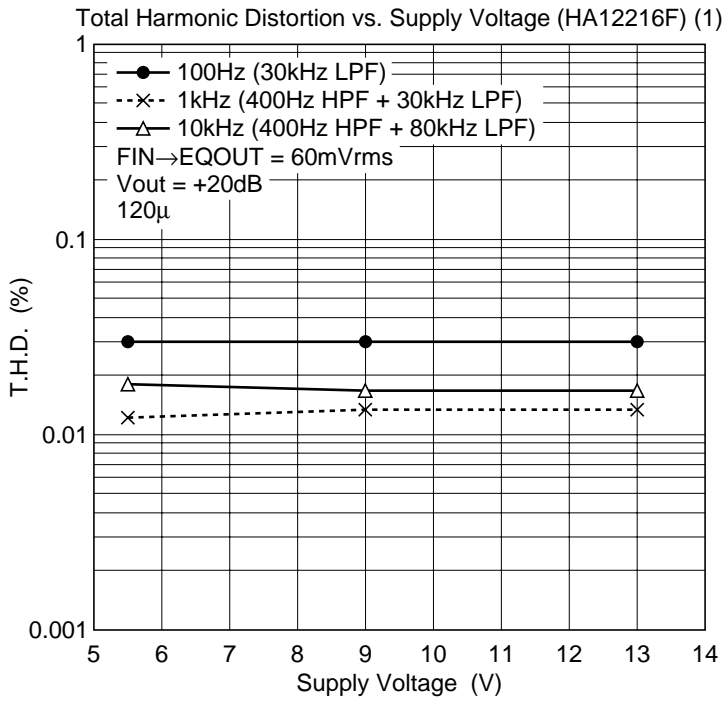

HA12216F/HA12221F Series

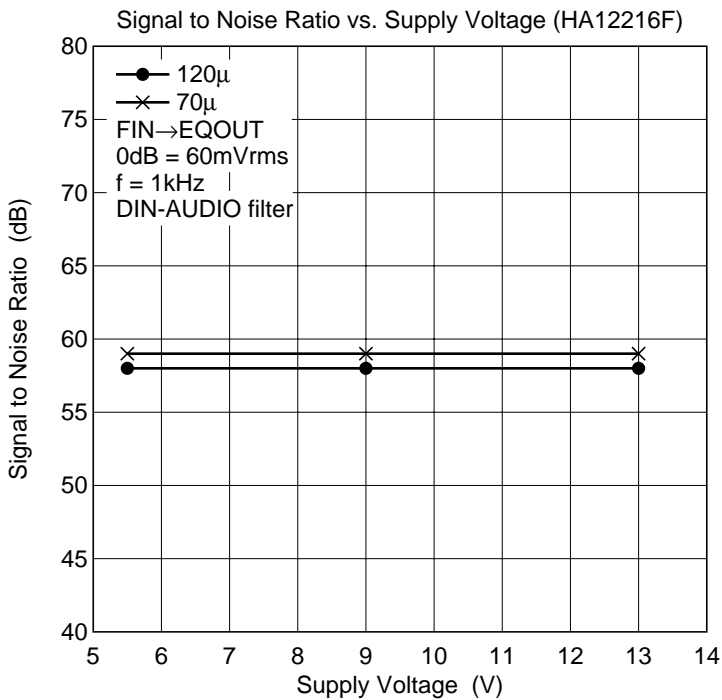
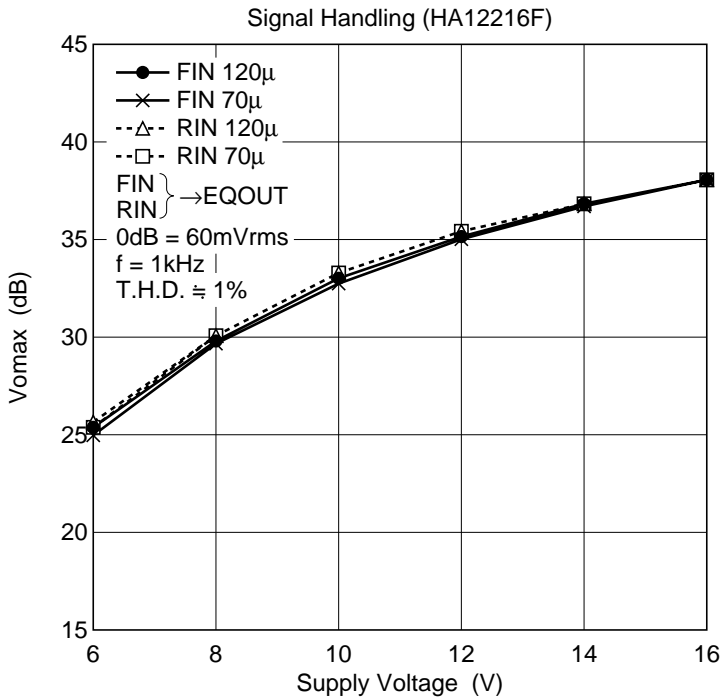

Ripple Rejection Ratio vs. Frequency (HA12216F) (1)

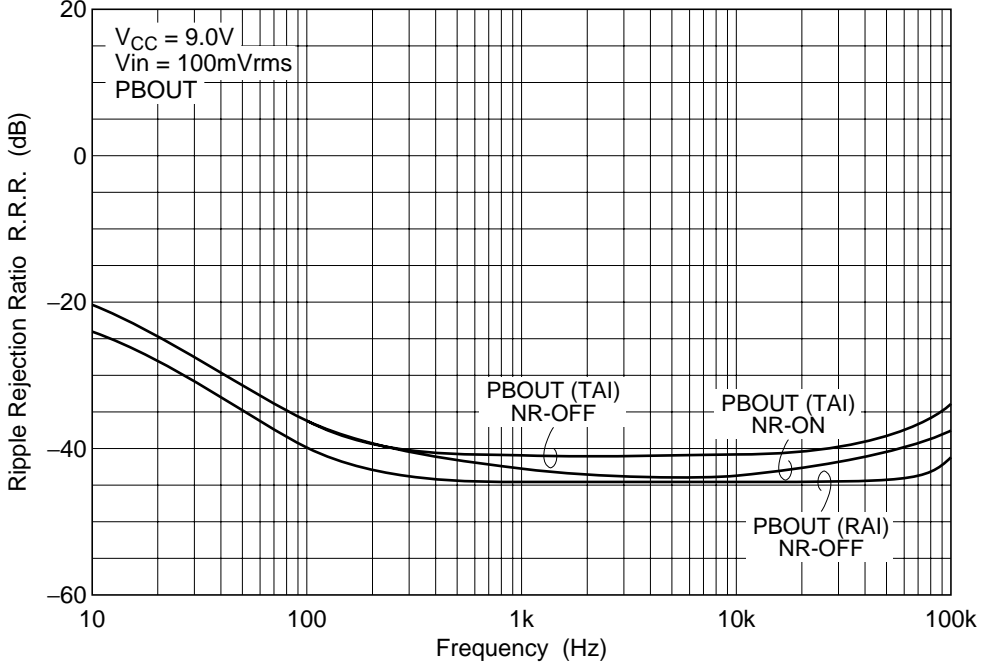

Ripple Rejection Ratio vs. Frequency (HA12216F) (2)

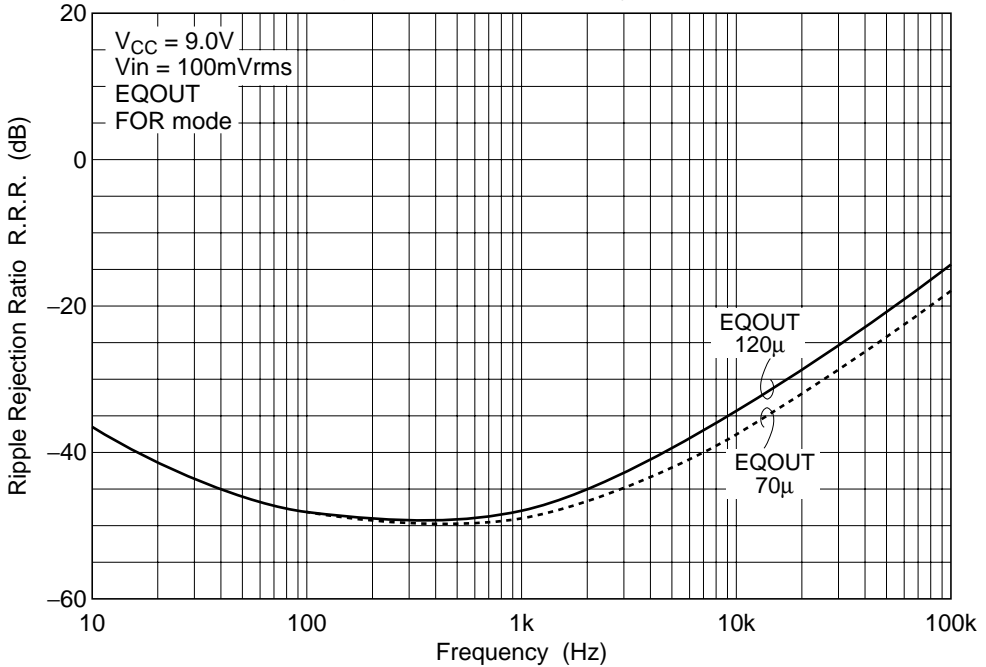

HA12216F/HA12221F Series

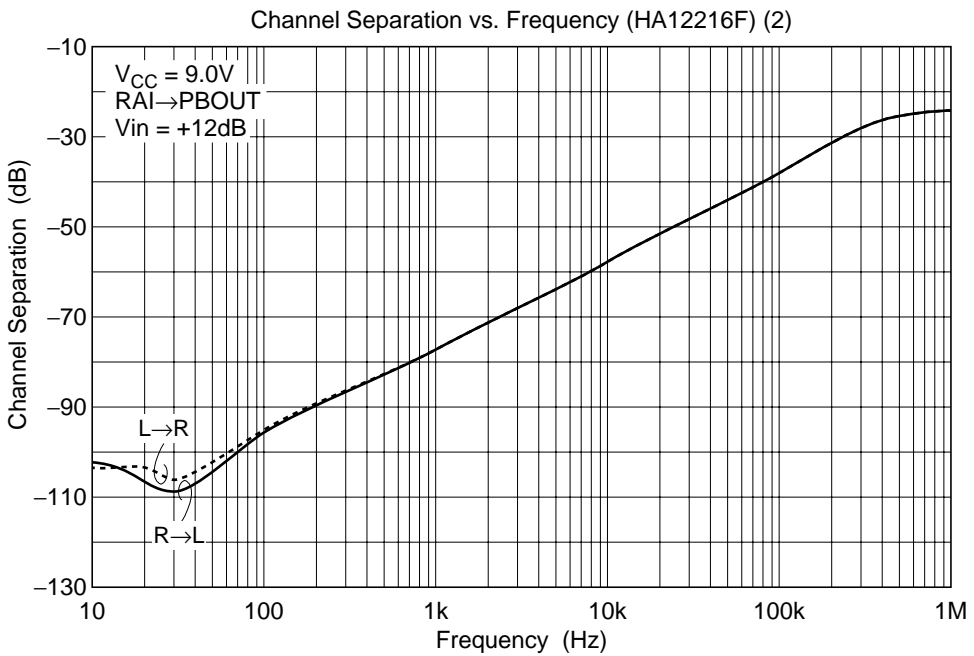
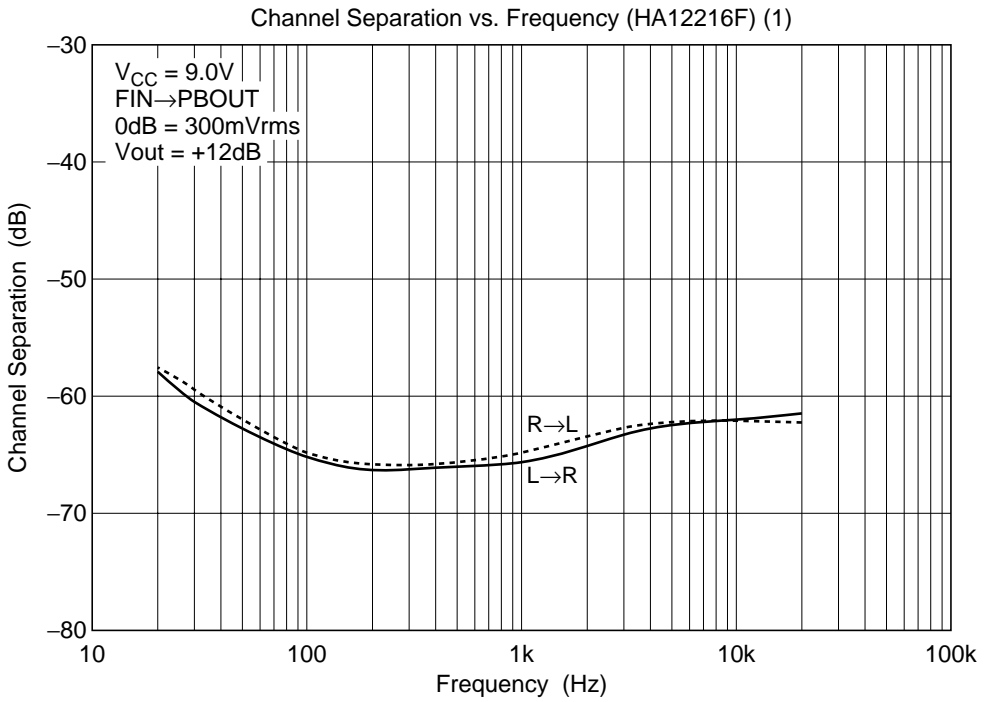

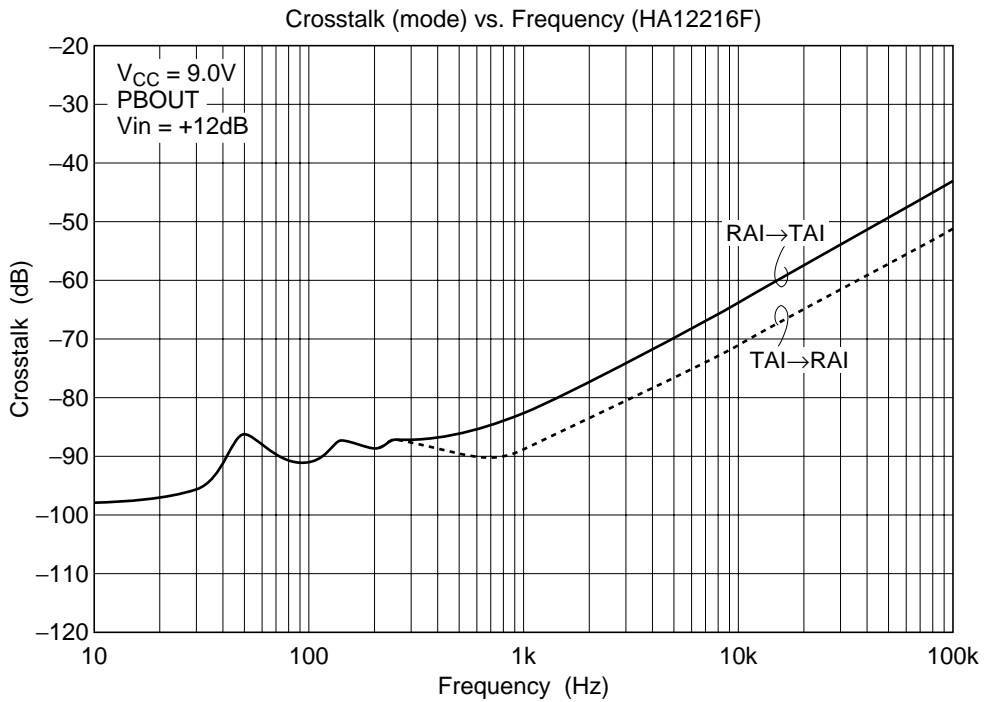
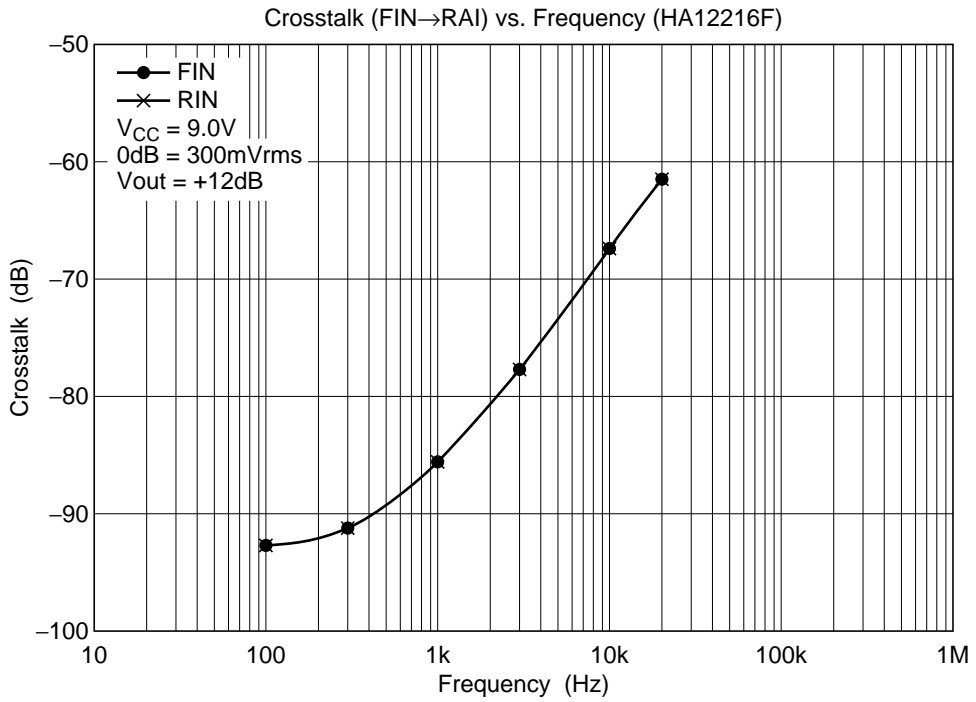

HA12216F/HA12221F Series

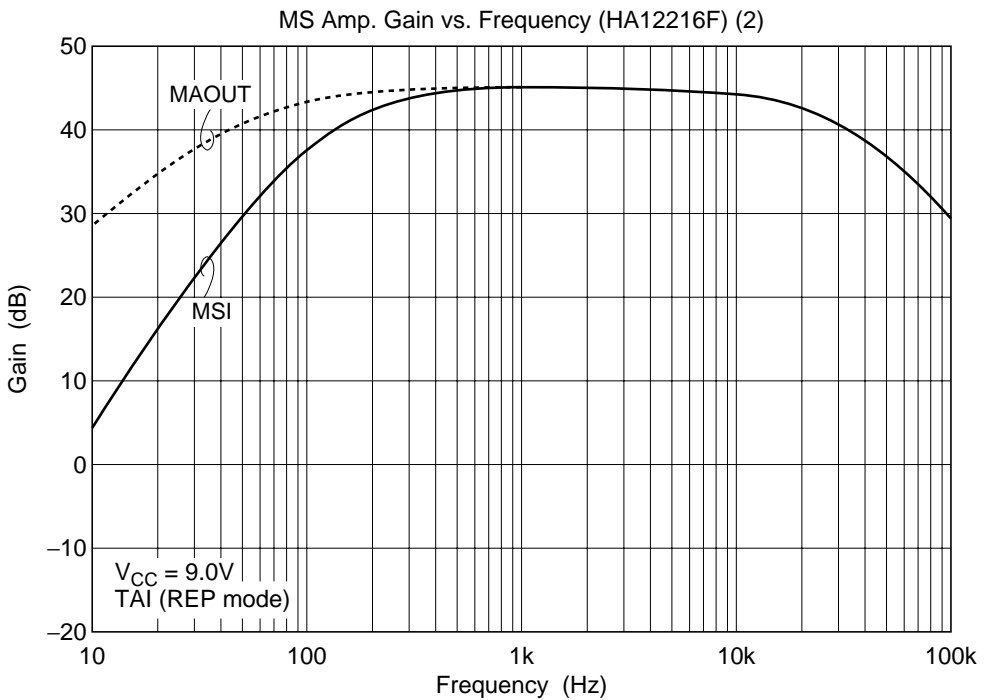
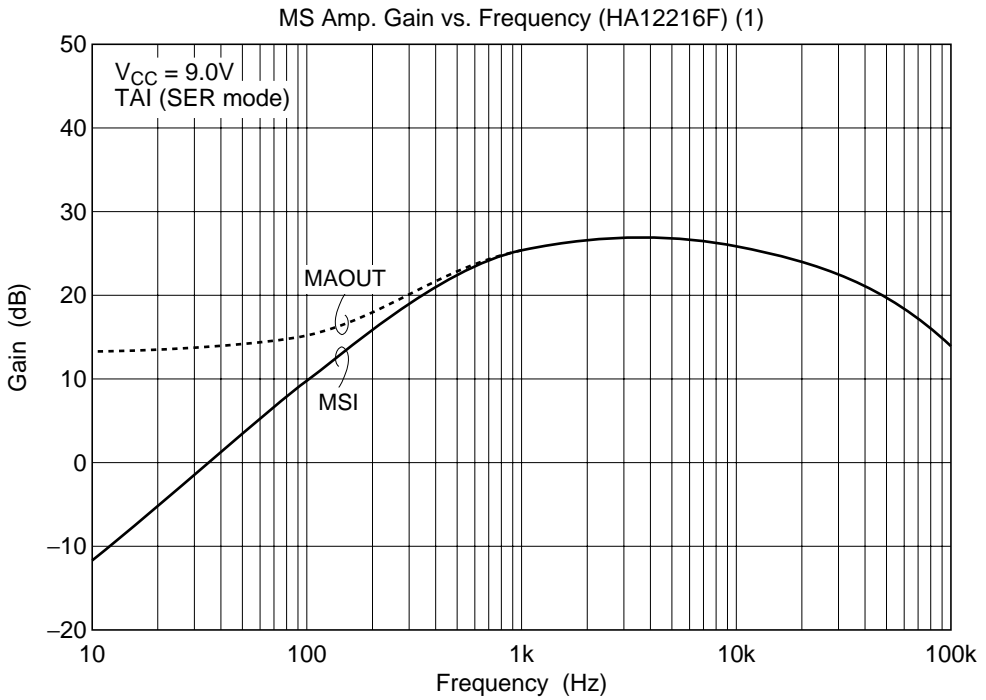

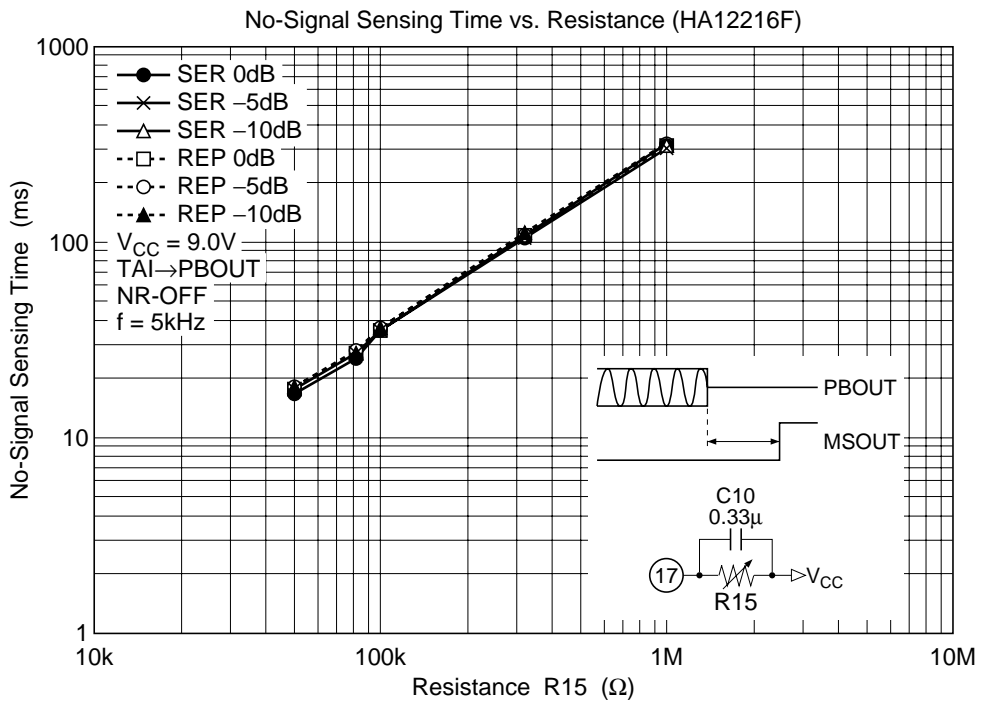
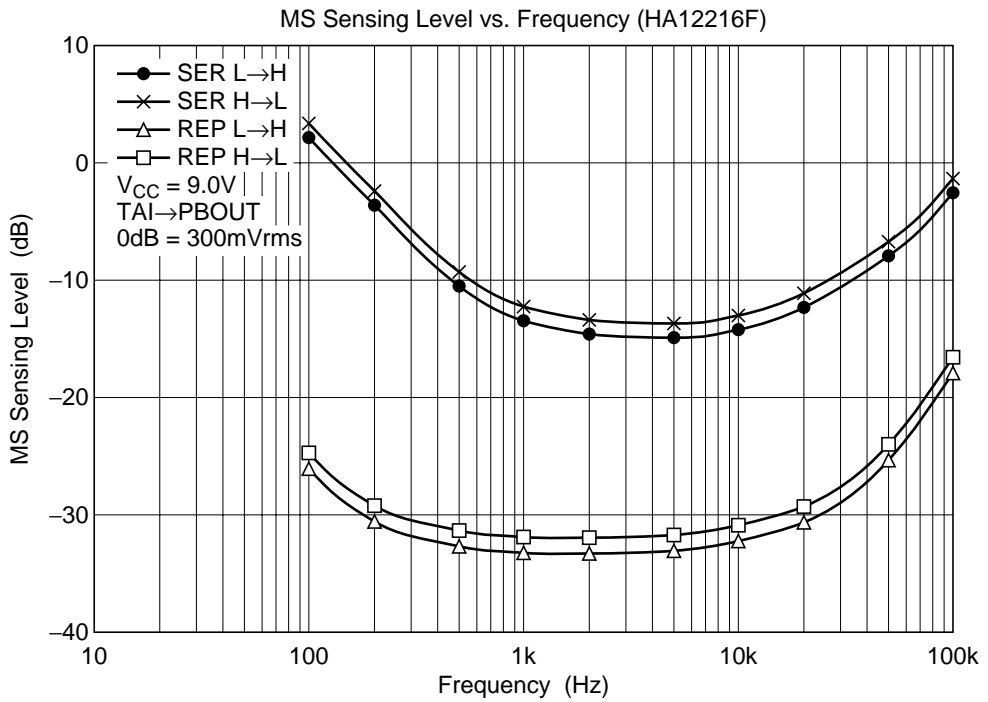

HA12216F/HA12221F Series

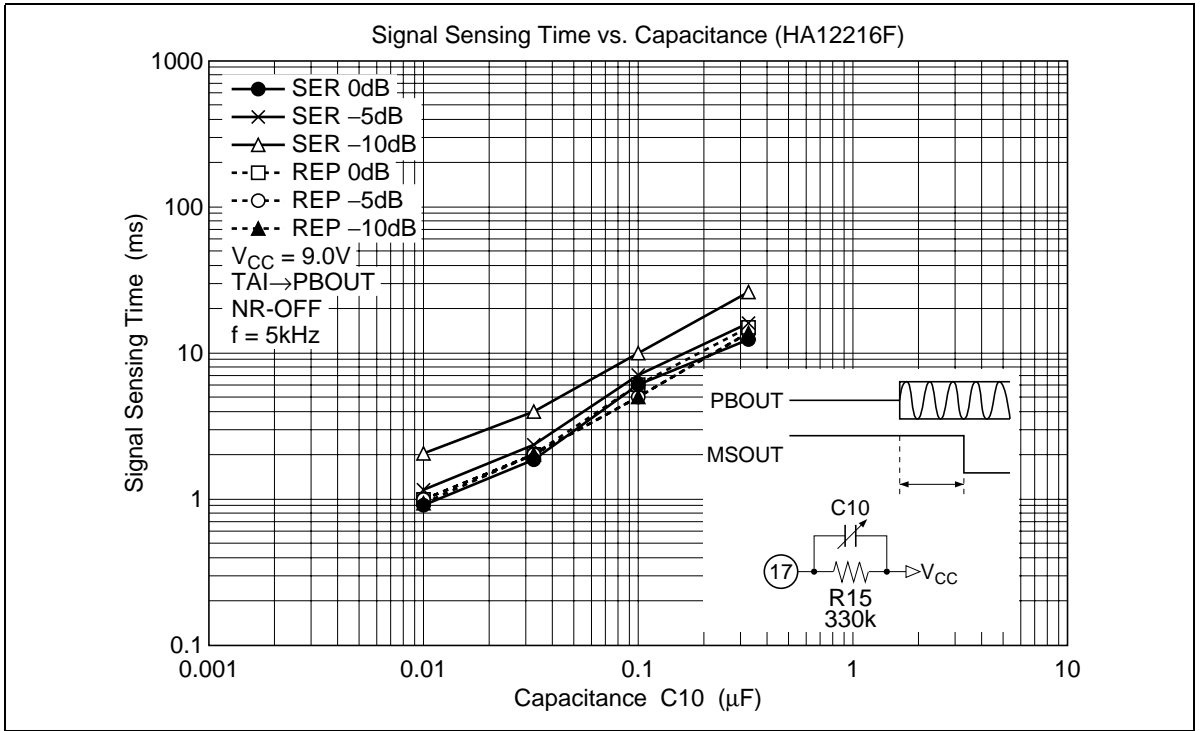

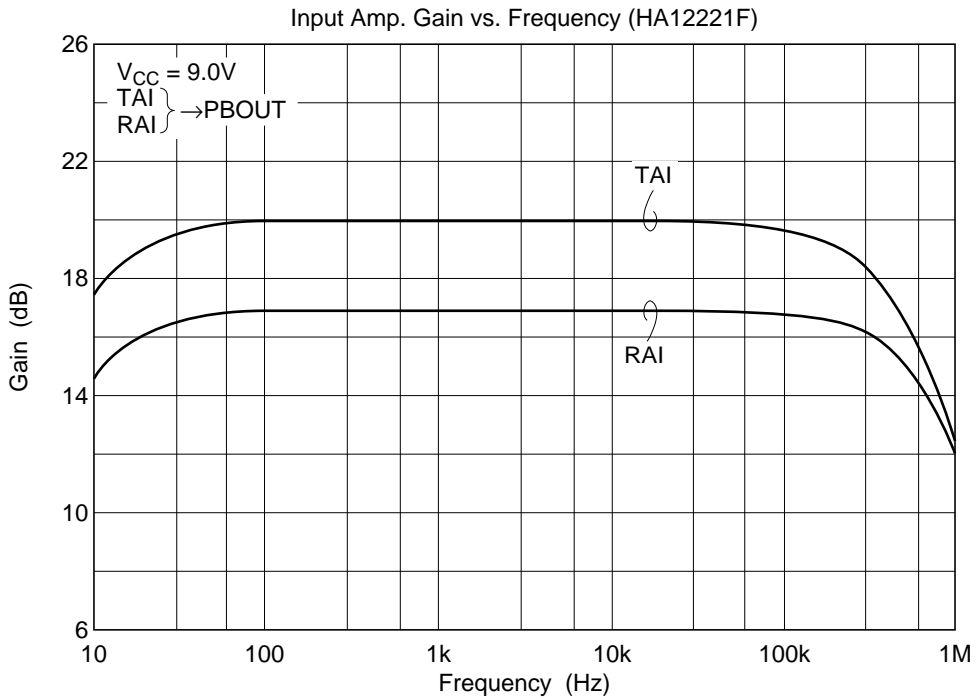
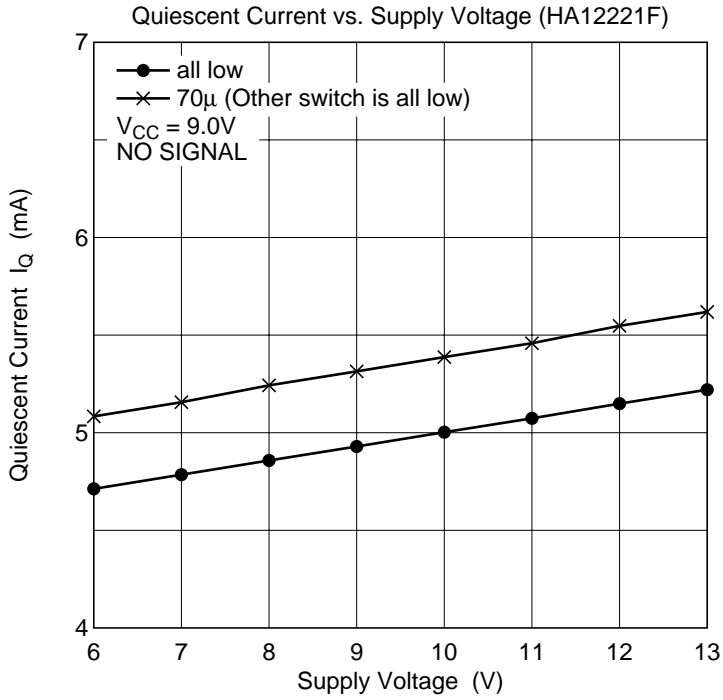

HA12216F/HA12221F Series

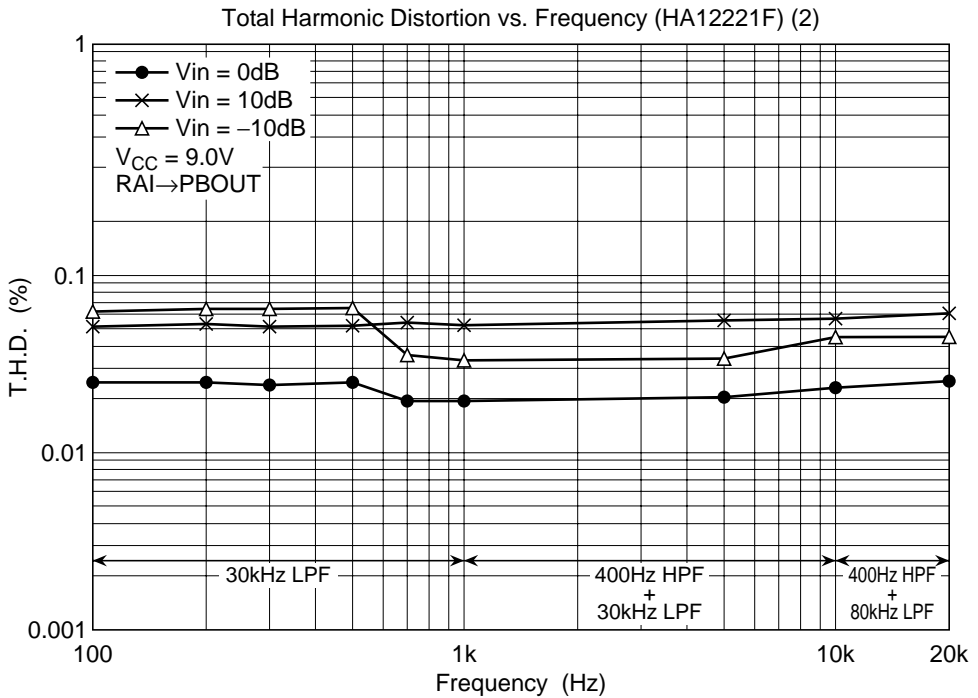
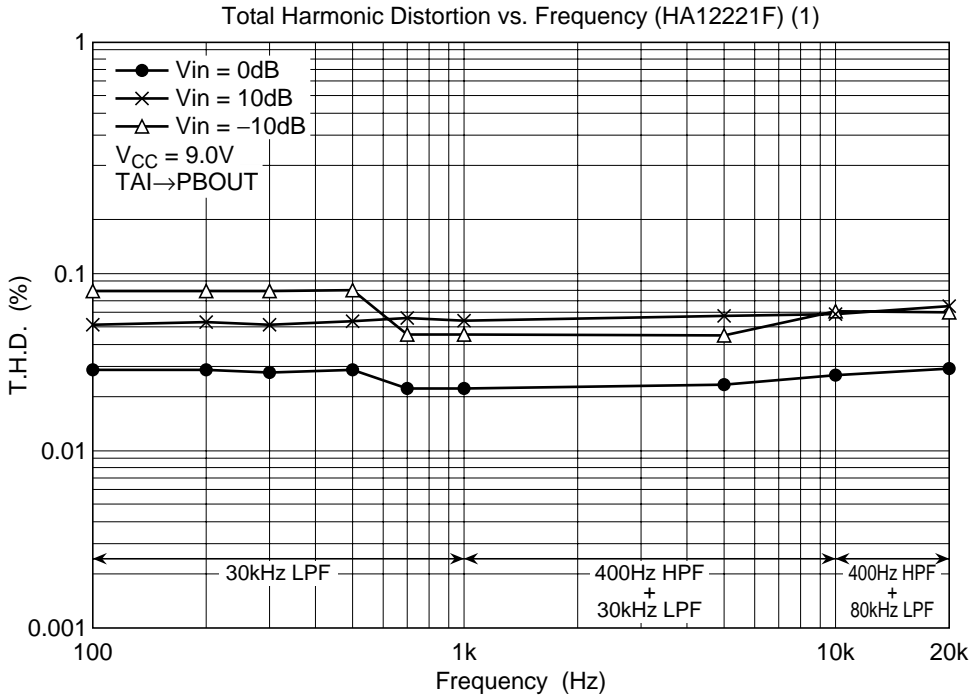

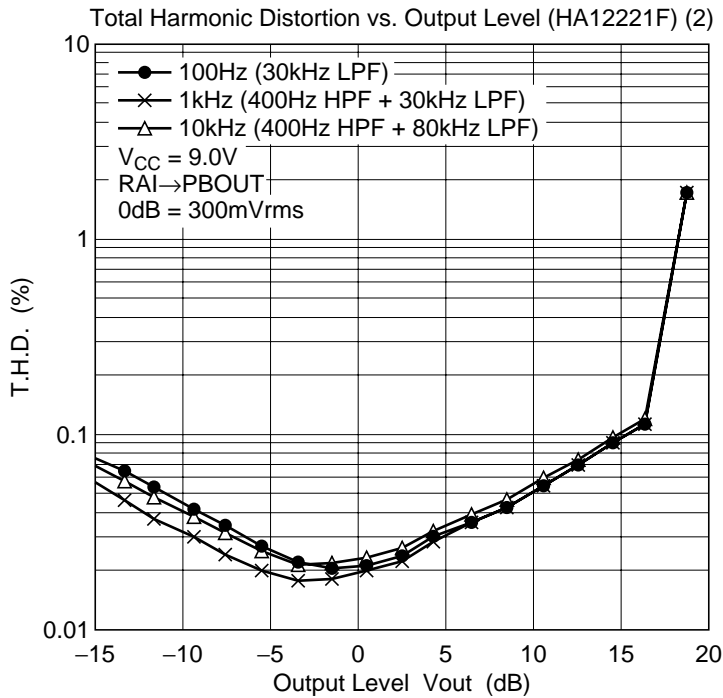
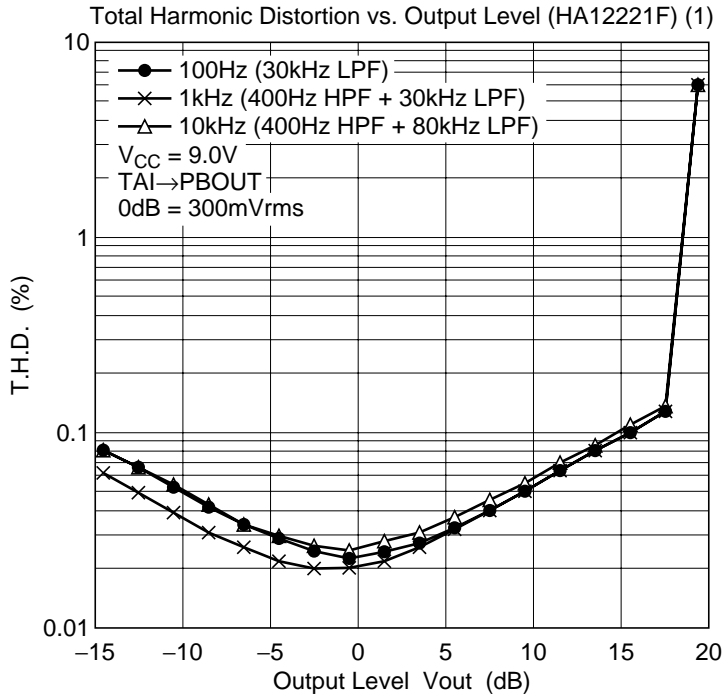

HA12216F/HA12221F Series

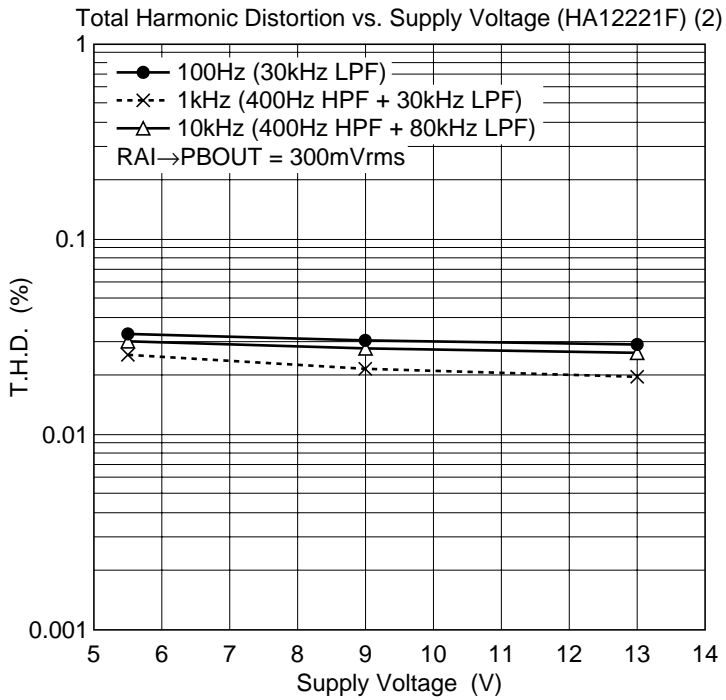
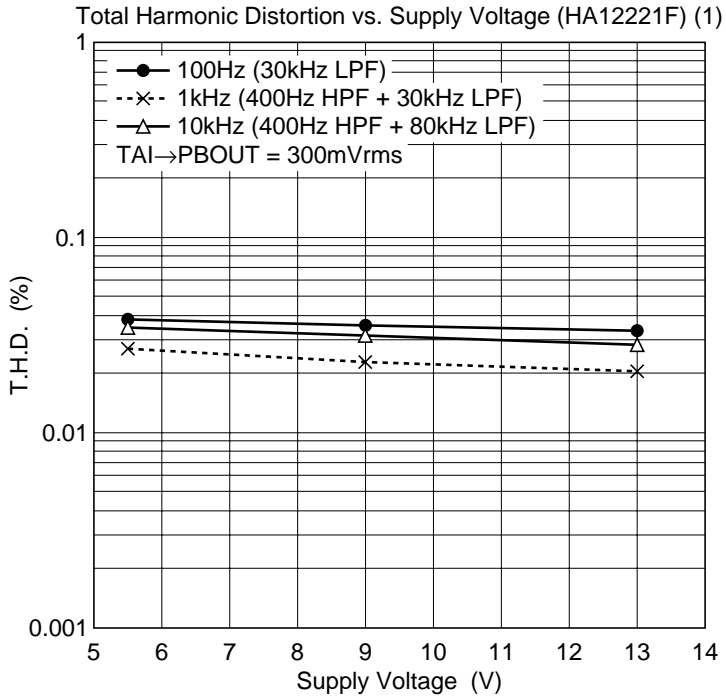

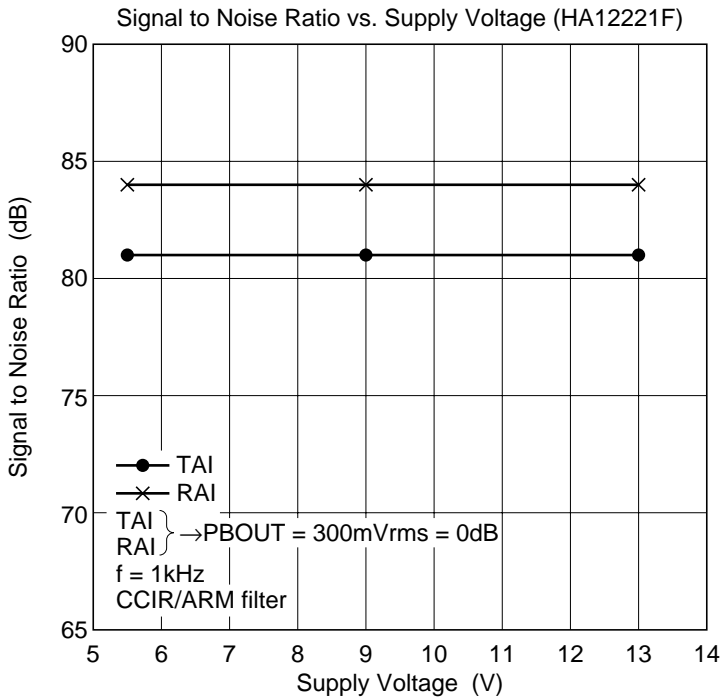
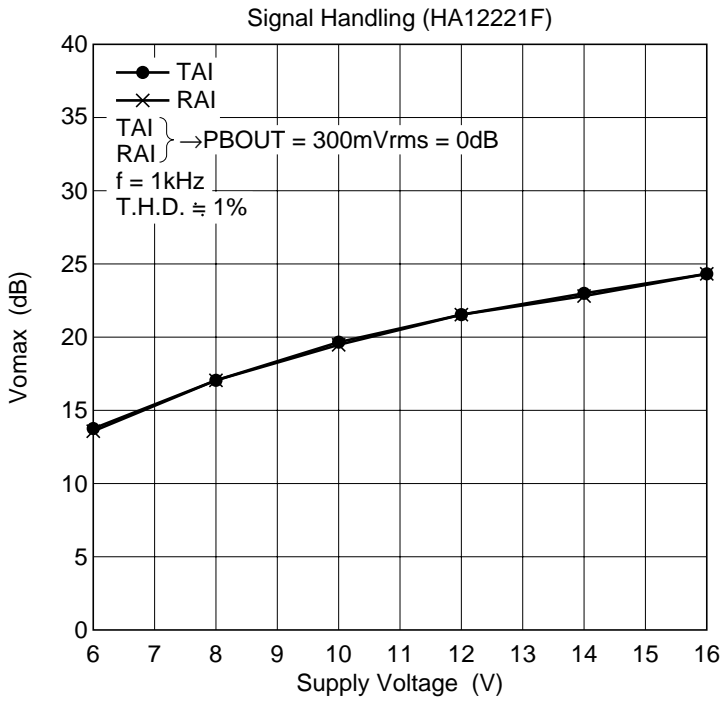

HA12216F/HA12221F Series

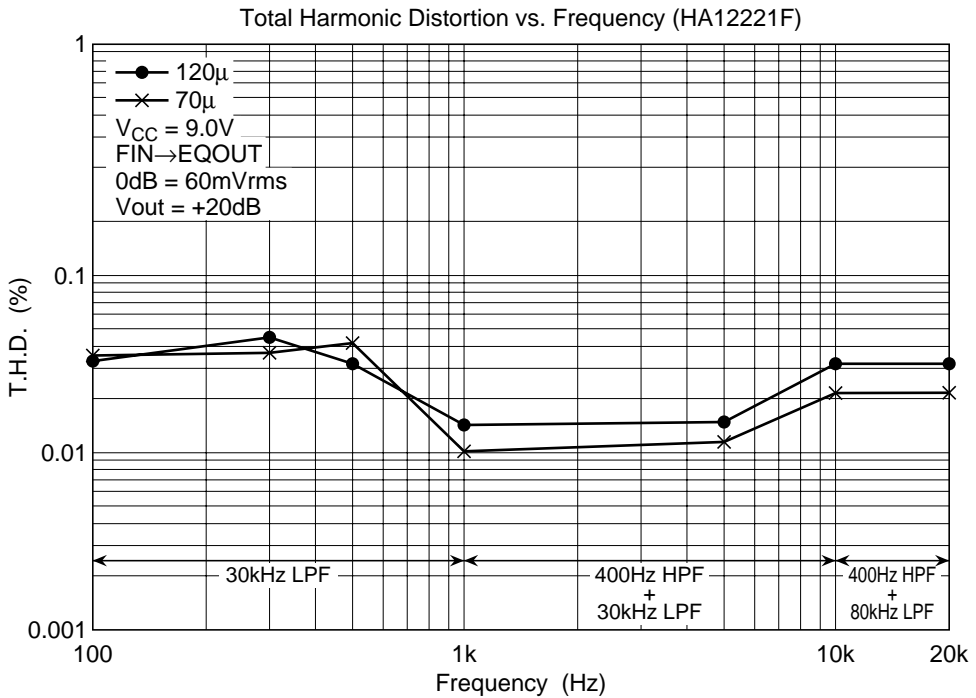
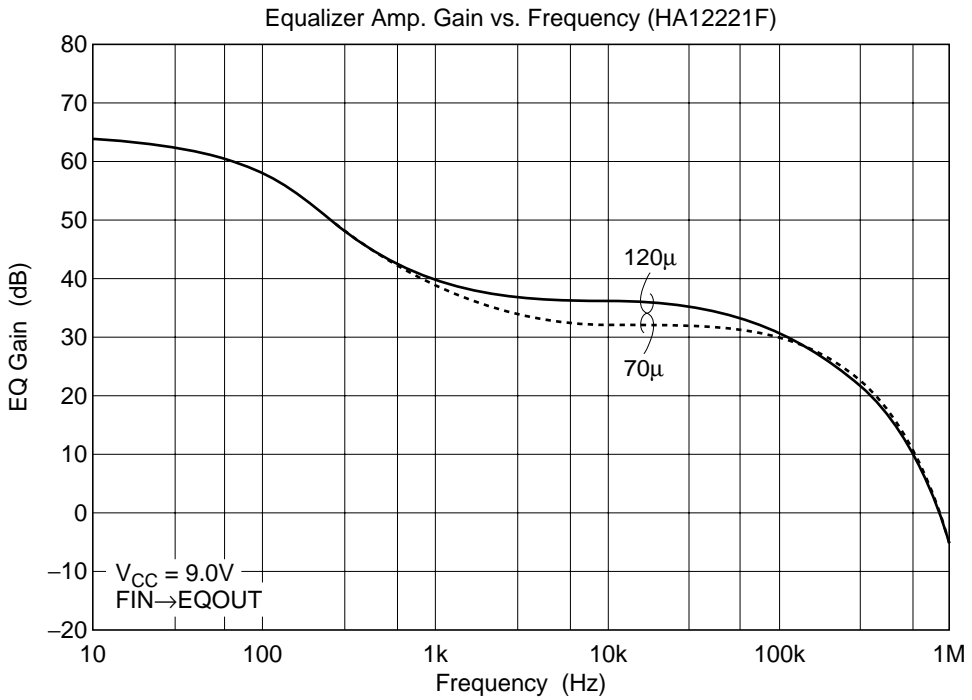

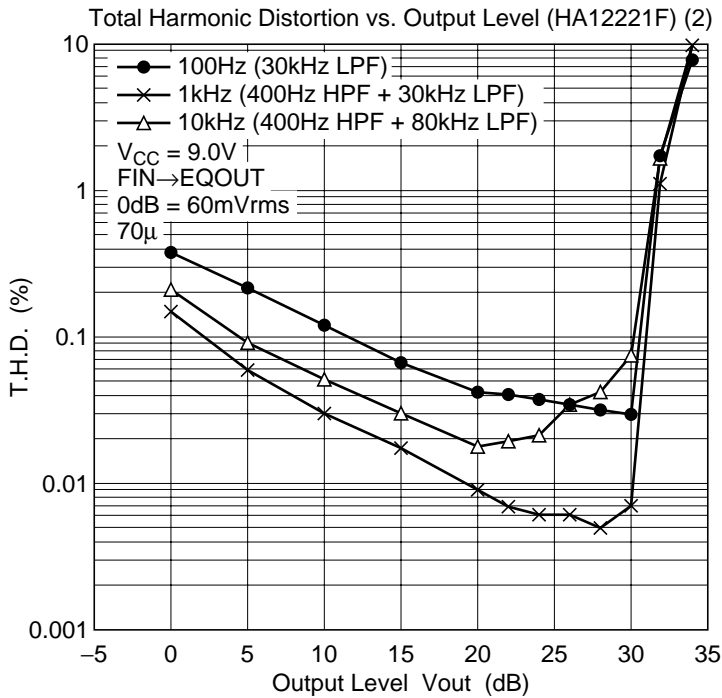
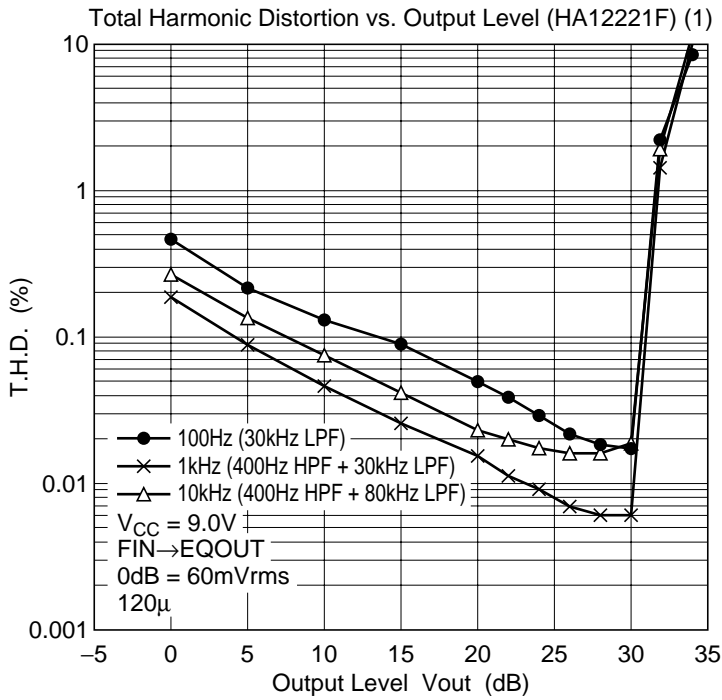

HA12216F/HA12221F Series

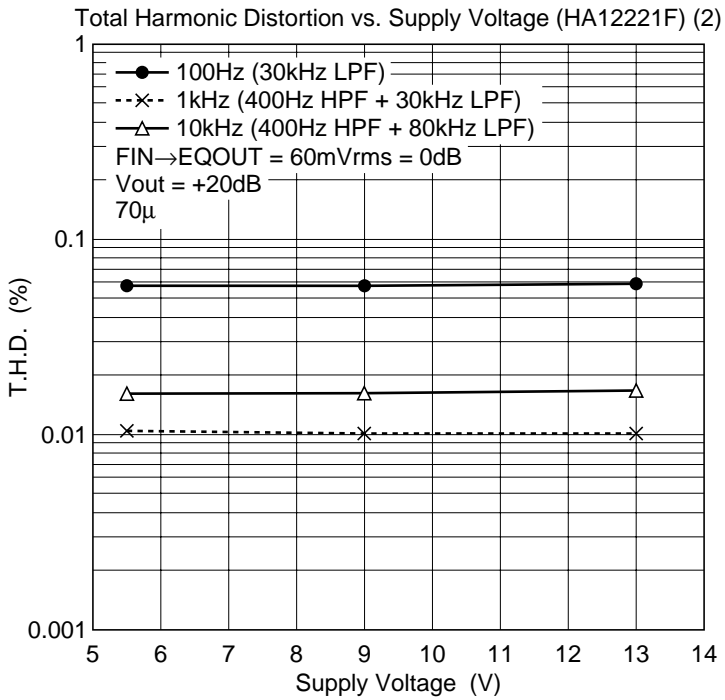
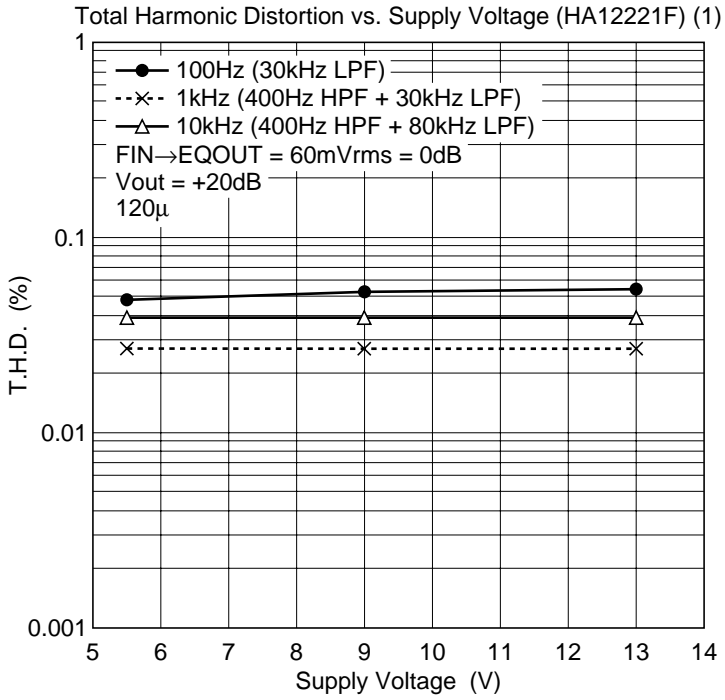

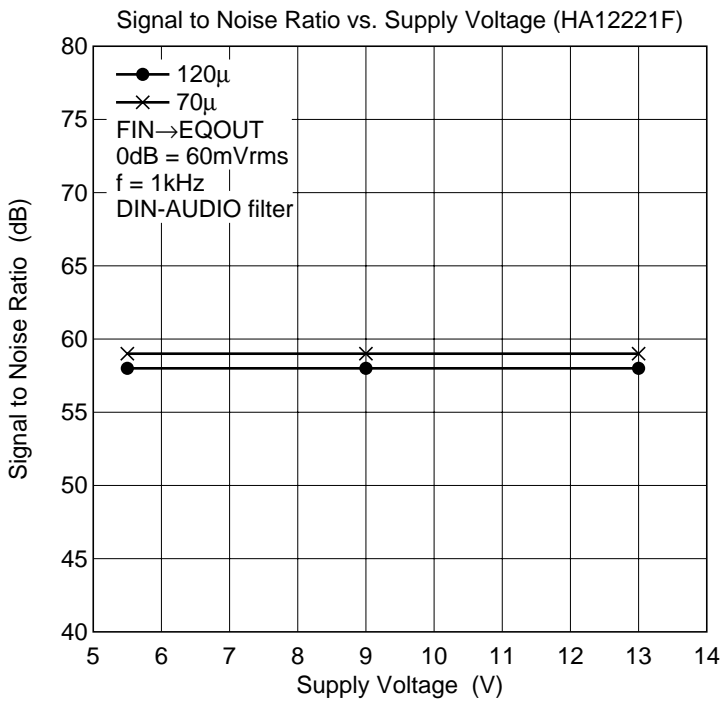
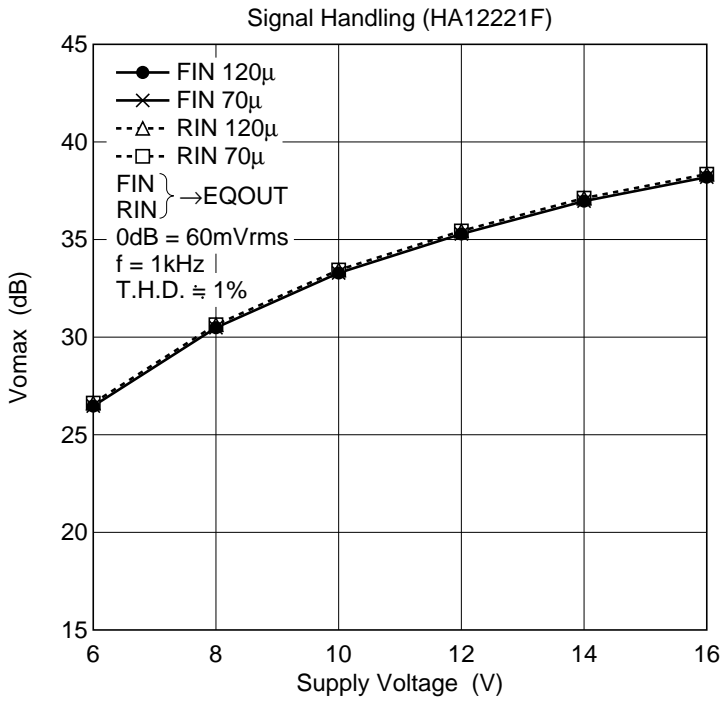

HA12216F/HA12221F Series

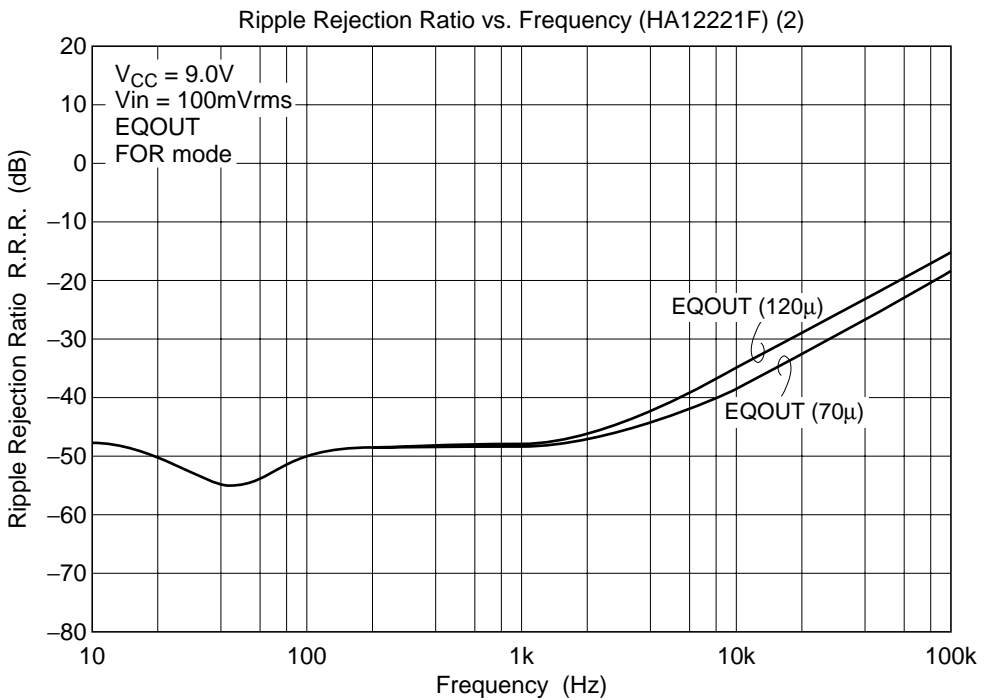
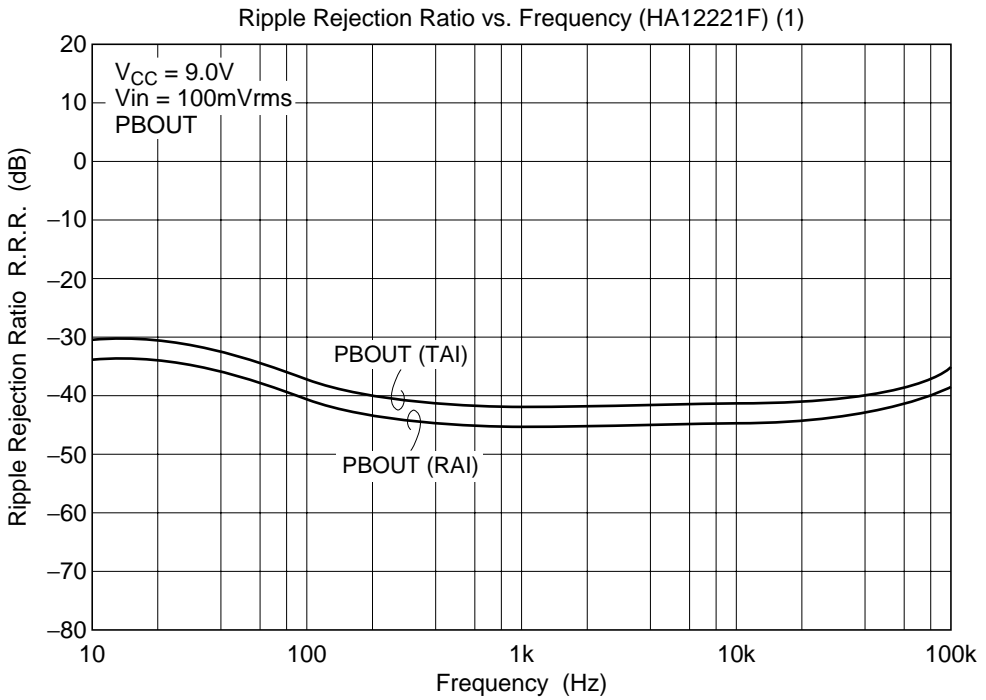

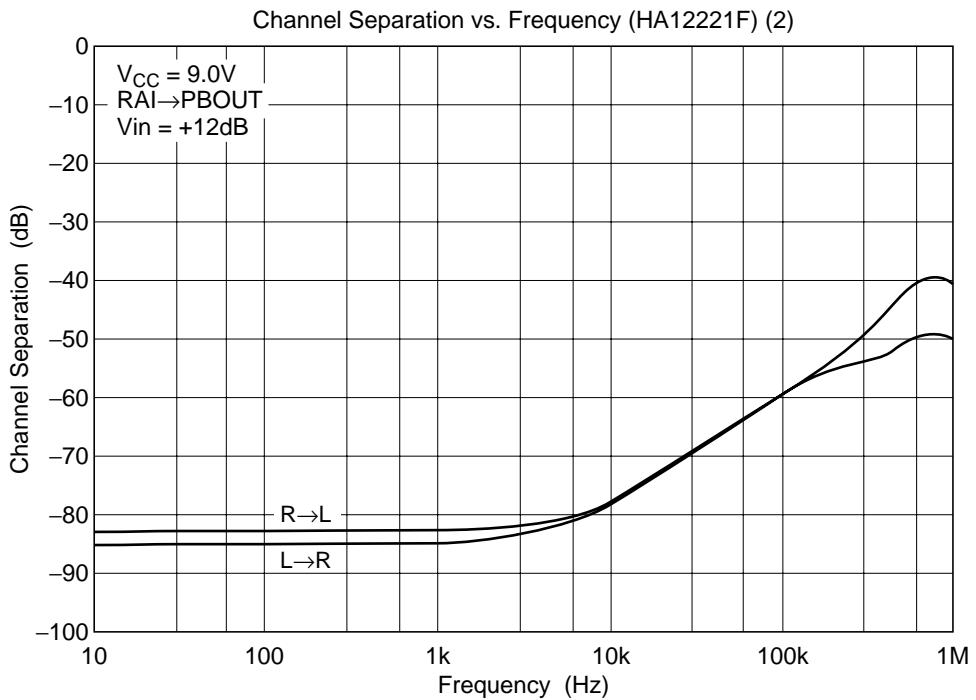
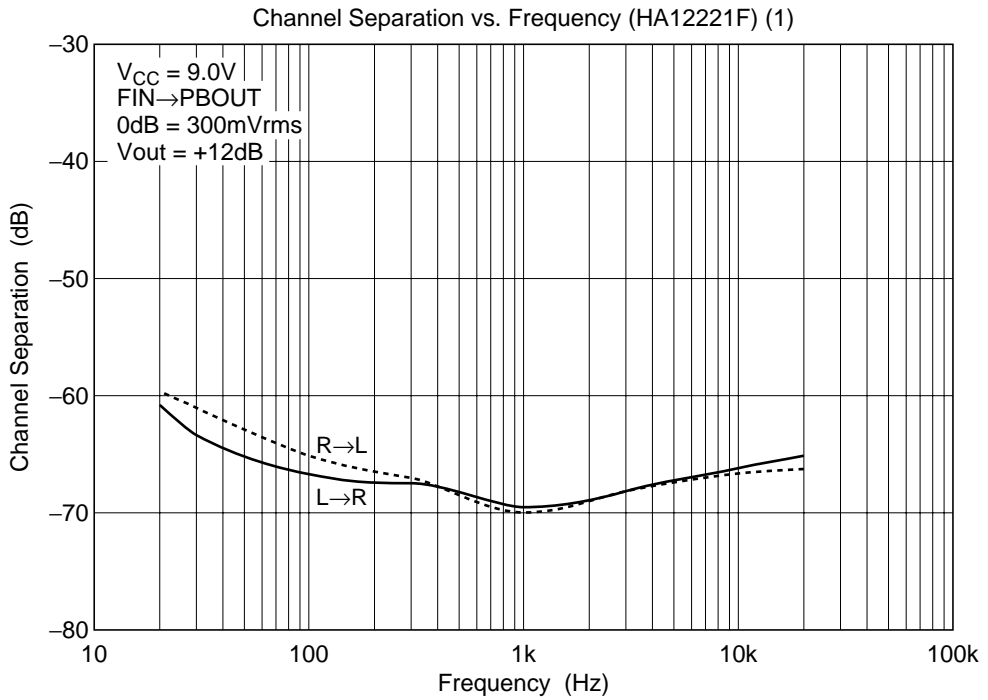

HA12216F/HA12221F Series

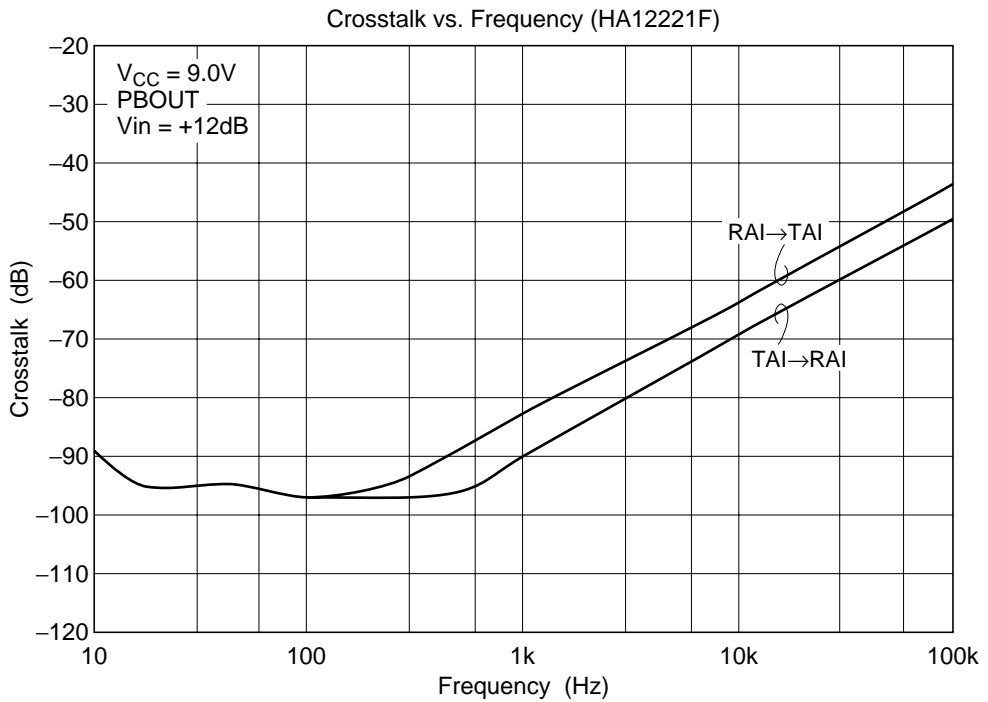
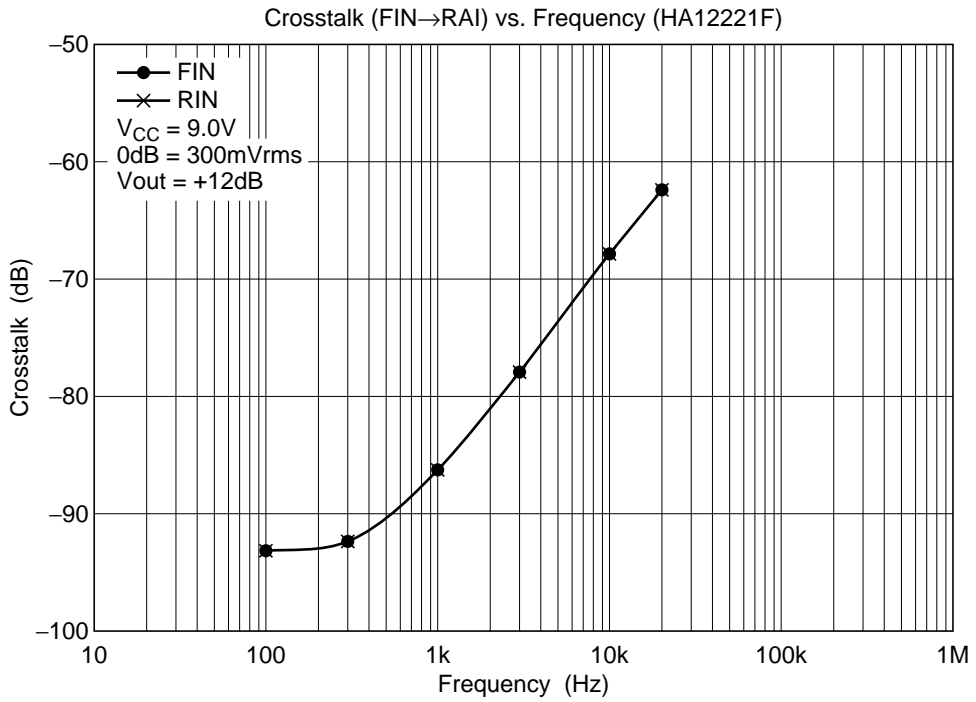

MS Amp. Gain vs. Frequency (HA12221F) (1)

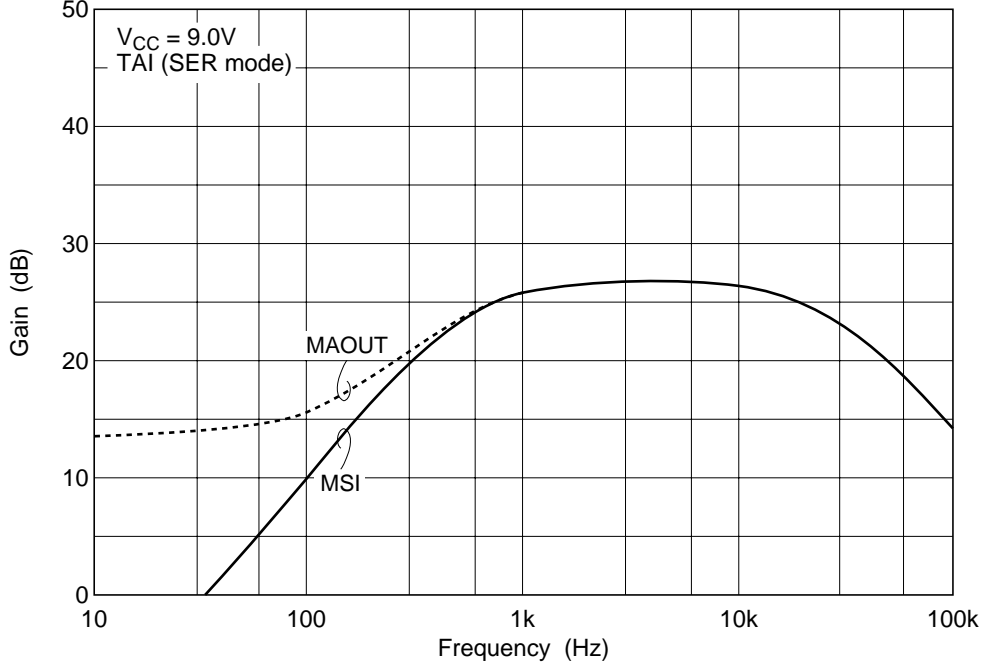

MS Amp. Gain vs. Frequency (HA12221F) (2)

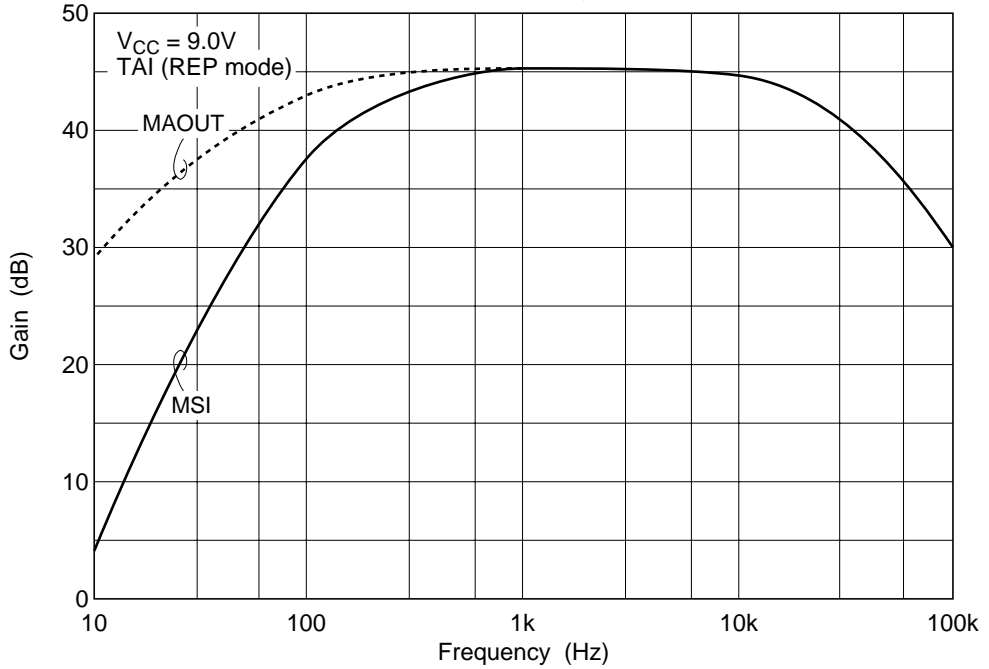

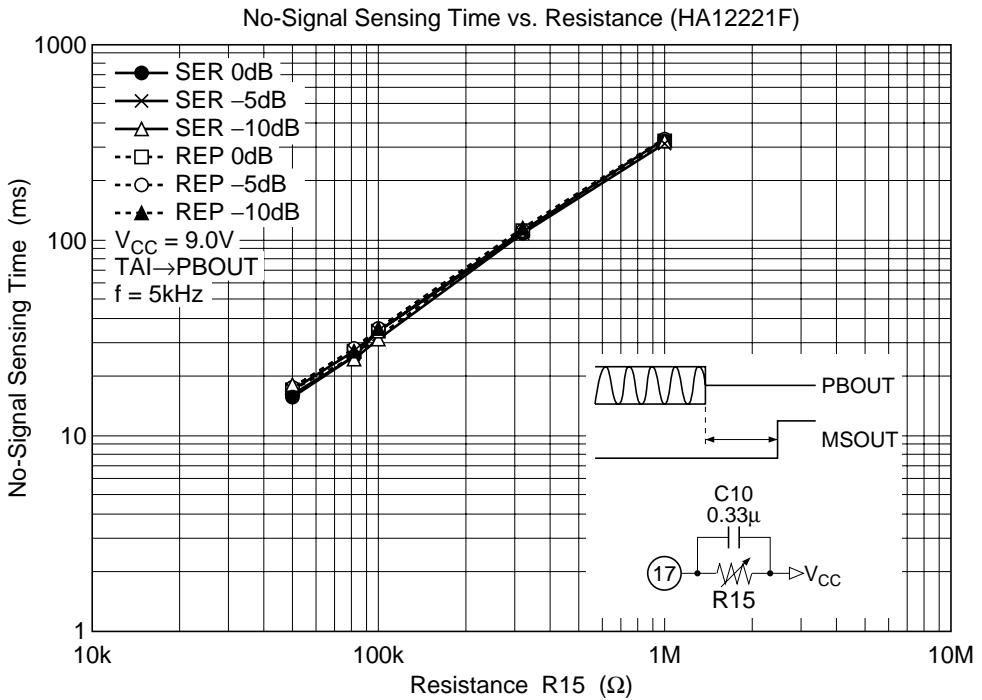
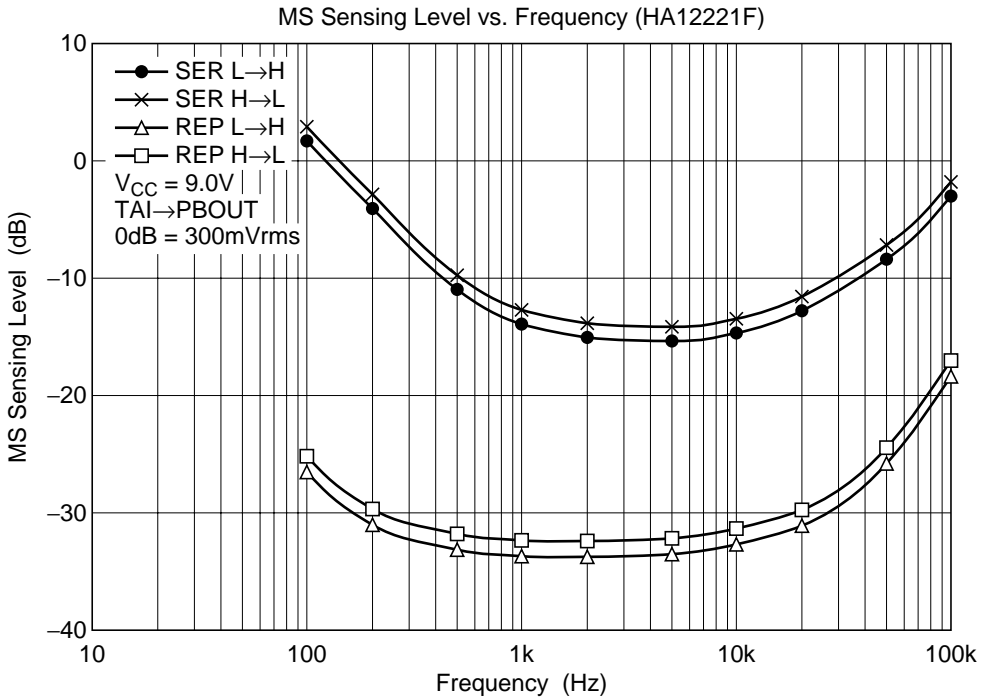

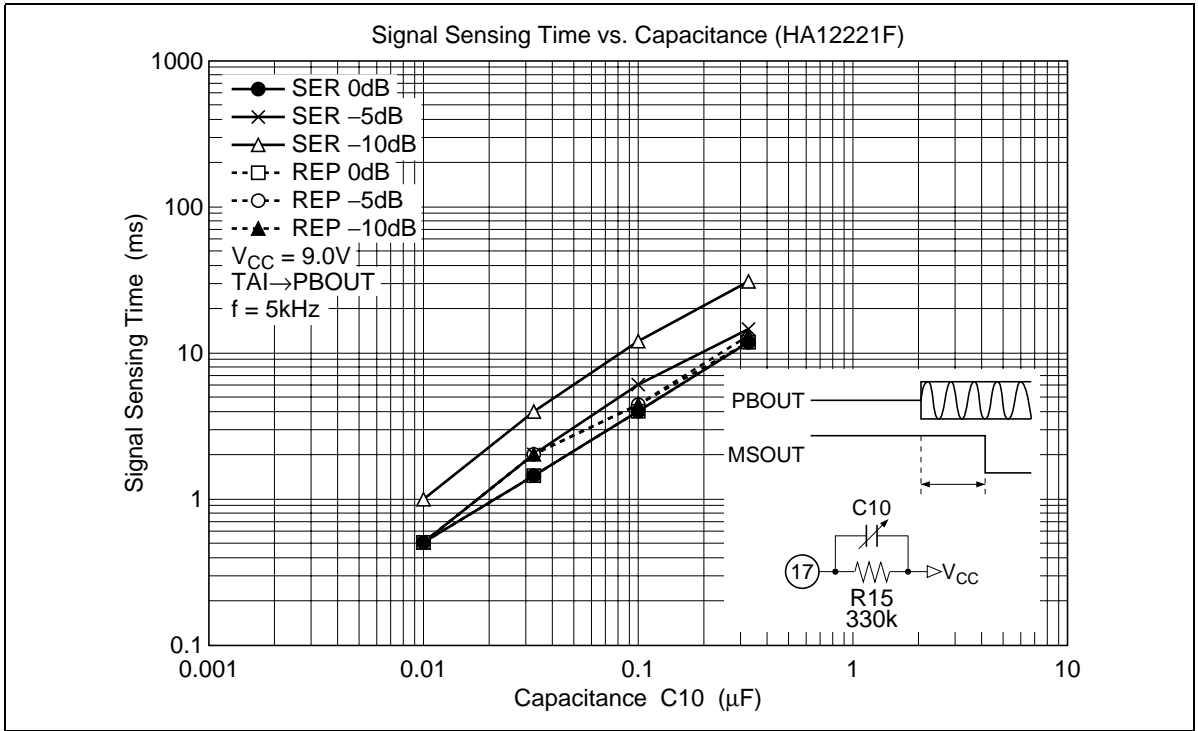

HA12216F/HA12221F Series

Package Dimensions

Unit: mm

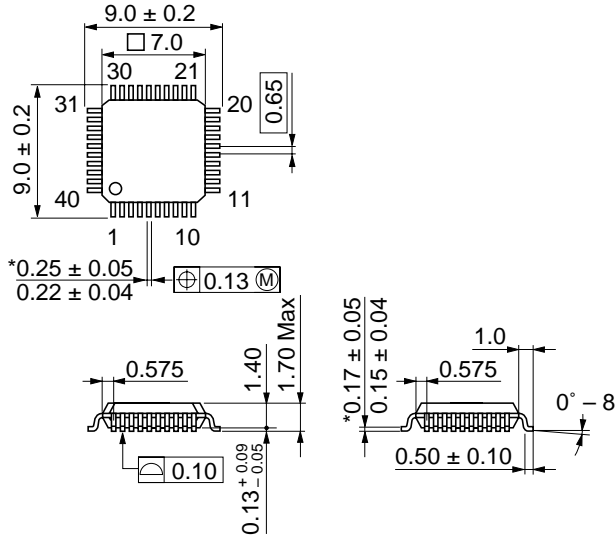

*Dimension including the plating thickness
Base material dimension

Hitachi Code	FP-40B
JEDEC	—
EIAJ	Conforms
Mass (reference value)	0.2 g

Disclaimer

1. Hitachi neither warrants nor grants licenses of any rights of Hitachi's or any third party's patent, copyright, trademark, or other intellectual property rights for information contained in this document. Hitachi bears no responsibility for problems that may arise with third party's rights, including intellectual property rights, in connection with use of the information contained in this document.
2. Products and product specifications may be subject to change without notice. Confirm that you have received the latest product standards or specifications before final design, purchase or use.
3. Hitachi makes every attempt to ensure that its products are of high quality and reliability. However, contact Hitachi's sales office before using the product in an application that demands especially high quality and reliability or where its failure or malfunction may directly threaten human life or cause risk of bodily injury, such as aerospace, aeronautics, nuclear power, combustion control, transportation, traffic, safety equipment or medical equipment for life support.
4. Design your application so that the product is used within the ranges guaranteed by Hitachi particularly for maximum rating, operating supply voltage range, heat radiation characteristics, installation conditions and other characteristics. Hitachi bears no responsibility for failure or damage when used beyond the guaranteed ranges. Even within the guaranteed ranges, consider normally foreseeable failure rates or failure modes in semiconductor devices and employ systemic measures such as fail-safes, so that the equipment incorporating Hitachi product does not cause bodily injury, fire or other consequential damage due to operation of the Hitachi product.
5. This product is not designed to be radiation resistant.
6. No one is permitted to reproduce or duplicate, in any form, the whole or part of this document without written approval from Hitachi.
7. Contact Hitachi's sales office for any questions regarding this document or Hitachi semiconductor products.

Sales Offices

HITACHI**Hitachi, Ltd.**

Semiconductor & Integrated Circuits.
Nippon Bldg., 2-6-2, Ohte-machi, Chiyoda-ku, Tokyo 100-0004, Japan
Tel: Tokyo (03) 3270-2111 Fax: (03) 3270-5109

URL NorthAmerica : <http://semiconductor.hitachi.com/>
 Europe : <http://www.hitachi-eu.com/hel/ecg>
 Asia : <http://sicapac.hitachi-asia.com>
 Japan : <http://www.hitachi.co.jp/Sicd/indx.htm>

For further information write to:

Hitachi Semiconductor
(America) Inc.
179 East Tasman Drive,
San Jose, CA 95134
Tel: <1>(408) 433-1990
Fax: <1>(408) 433-0223

Hitachi Europe GmbH
Electronic Components Group
Dornacher Straße 3
D-85622 Feldkirchen, Munich
Germany
Tel: <49> (89) 9 9180-0
Fax: <49> (89) 9 29 30 00

Hitachi Europe Ltd.
Electronic Components Group.
Whitebrook Park
Lower Cookham Road
Maidenhead
Berkshire SL6 8YA, United Kingdom
Tel: <44> (1628) 585000
Fax: <44> (1628) 585160

Hitachi Asia Ltd.
Hitachi Tower
16 Collyer Quay #20-00,
Singapore 049318
Tel : <65>-538-6533/538-8577
Fax : <65>-538-6933/538-3877
URL : <http://www.hitachi.com.sg>

Hitachi Asia Ltd.
(Taipei Branch Office)
4/F, No. 167, Tun Hwa North Road,
Hung-Kuo Building,
Taipei (105), Taiwan
Tel : <886>-(2)-2718-3666
Fax : <886>-(2)-2718-8180
Telex : 23222 HAS-TP
URL : <http://www.hitachi.com.tw>

Hitachi Asia (Hong Kong) Ltd.
Group III (Electronic Components)
7/F., North Tower,
World Finance Centre,
Harbour City, Canton Road
Tsim Sha Tsui, Kowloon,
Hong Kong
Tel : <852>-(2)-735-9218
Fax : <852>-(2)-730-0281
URL : <http://www.hitachi.com.hk>

Copyright © Hitachi, Ltd., 2000. All rights reserved. Printed in Japan.
Colophon 2.0