

---

# HA12219NT

Audio Signal Processor for Cassette Deck

# HITACHI

ADE-207-258A

2nd Edition  
July 1998

---

## Description

HA12219NT is silicon monolithic bipolar IC providing PB equalizer, REC equalizer system and each electronic control switch in one chip.

## Functions

- PB equalizer    × 2 channel
- REC equalizer   × 2 channel
- Each electronic control switch to change REC/PB etc.
- REC MUTE
- REC head return switch

## Features

- REC equalizer is very small number of external parts, built-in 2 types of frequency characteristics.
- PB equalizer circuit built-in.
- REC /PB are possible with TYPE I/II.
- Controllable from direct micro-computer output.
- Available to reduce substrate-area because of high integration and small external parts.

# HA12219NT

**Pin Description, Equivalent Circuit** ( $V_{CC} = 12\text{ V}$ ,  $V_{ref} = 5.6\text{ V}$ ,  $T_a = 25^\circ\text{C}$ , No signal, The value in the table show typical value.)

Pin No.	Pin Name	Note	Equivalent Circuit	Pin Description
1	$V_{CC}$	$V = V_{CC}$		$V_{CC}$ pin
2	REC-OUT(L)	$V = V_{ref}$		REC-EQ output
3	REC-OUT(R)			
4	REC-RETURN	$V = V_{ref}$ $V' = V_{ref}$		REC return
5	PB-IN B(L)			PB B deck input
6	PB-IN B(R)			
7	VREF	$V = V_{ref}$ $V' = V_{CC} / 2$		Reference
8	PB-IN A(L)	$V = V_{ref}$		PB A deck input
9	PB-IN A(R)			

**Pin Description, Equivalent Circuit** ( $V_{CC} = 12\text{ V}$ ,  $V_{ref} = 5.6\text{ V}$ ,  $T_a = 25^\circ\text{C}$ , No signal, The value in the table show typical value.) (cont)

Pin No.	Pin Name	Note	Equivalent Circuit	Pin Description
12	PB-NF(R)	PB-IN = $V_{ref}$		PB-EQ feed back
17	PB-NF(L)			
13	PB-EQ(R)	PB-OUT = $V_{ref}$		NAB output
16	PB-EQ(L)			
21	REC-IN(R)	$V = V_{ref}$		REC-EQ input
22	REC-IN(L)			
14	PB-OUT(R)	$V = V_{ref}$		PB output
15	PB-OUT(L)			
18	A $\bar{I}0/70$	$I = 20\ \mu\text{A}$		Mode control input
19	A/B			
20	B $\bar{I}/I$			

---

# HA12219NT

---

**Pin Description, Equivalent Circuit** ( $V_{CC} = 12\text{ V}$ ,  $V_{ref} = 5.6\text{ V}$ ,  $T_a = 25^\circ\text{C}$ , No signal, The value in the table show typical value.) (cont)

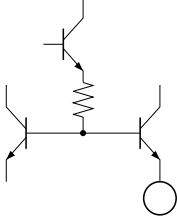
Pin No.	Pin Name	Note	Equivalent Circuit	Pin Description
10	IREF	$V = 1.2\text{ V}$		Equalizer reference current input
11	GND			GND pin

---

Block Diagram

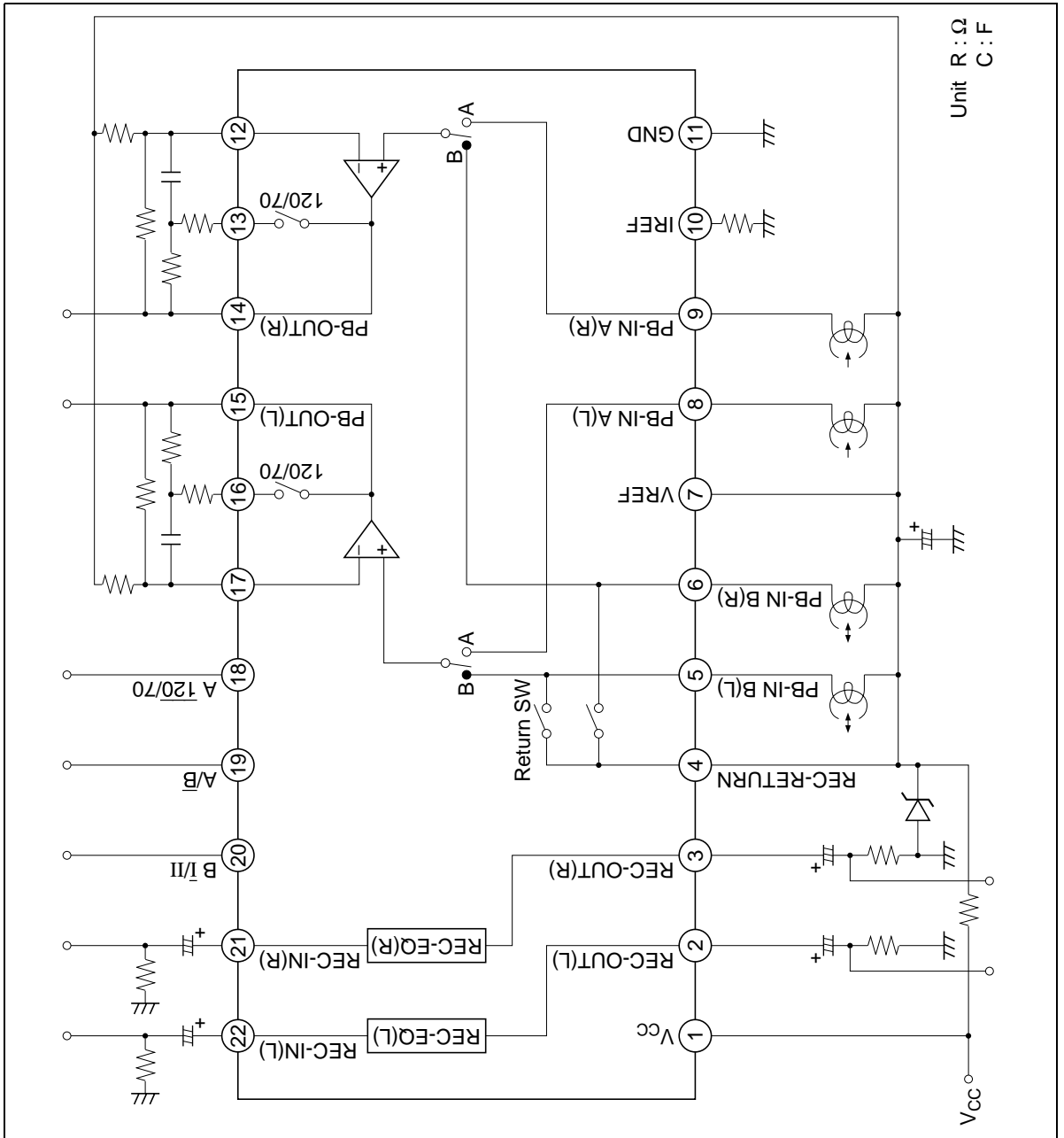

---

# HA12219NT

---

## Parallel Data Format

Pin No.	Pin Name	Lo	Mid	Hi
18	A $\overline{120/70}$	*	—	*
19	A $\overline{B}$	B Return SW OFF REC Mute ON	A Return SW ON REC Mute ON	A Return SW ON REC Mute OFF
20	B $\overline{I/II}$	REC-EQ * TYPE I	—	REC-EQ * TYPE II

Note: PB-EQ 120/70 logic

A $\overline{120/70}$	B $\overline{I/II}$	A $\overline{B}$		
		Lo	Mid	Hi
Lo	Lo	120 $\mu$	120 $\mu$	120 $\mu$
Lo	Hi	70 $\mu$	120 $\mu$	120 $\mu$
Hi	Lo	120 $\mu$	70 $\mu$	70 $\mu$
Hi	Hi	70 $\mu$	70 $\mu$	70 $\mu$

**Functional Description**

**Power Supply Range**

HA12219NT is designed to operate on single supply, shown by table 1.

**Table 1 Supply Voltage**

Item	Power Supply Range
Single Supply	9.5 V to 15.0 V

**Reference Voltage**

As AC reference ( $V_{ref}$ ) of this IC has not a current drivability,  $V_{ref}$  fluctuates by A/B switching of PB-EQ.

Provided it causes you anxiety, please supply 7 pin with approximate  $1/2 V_{CC}$  voltage.

For example, a suitable circuit is shown by figure 1.

This IC has a capacitor charger for the  $V_{ref}$ , indicated to the pin interface circuit figure.

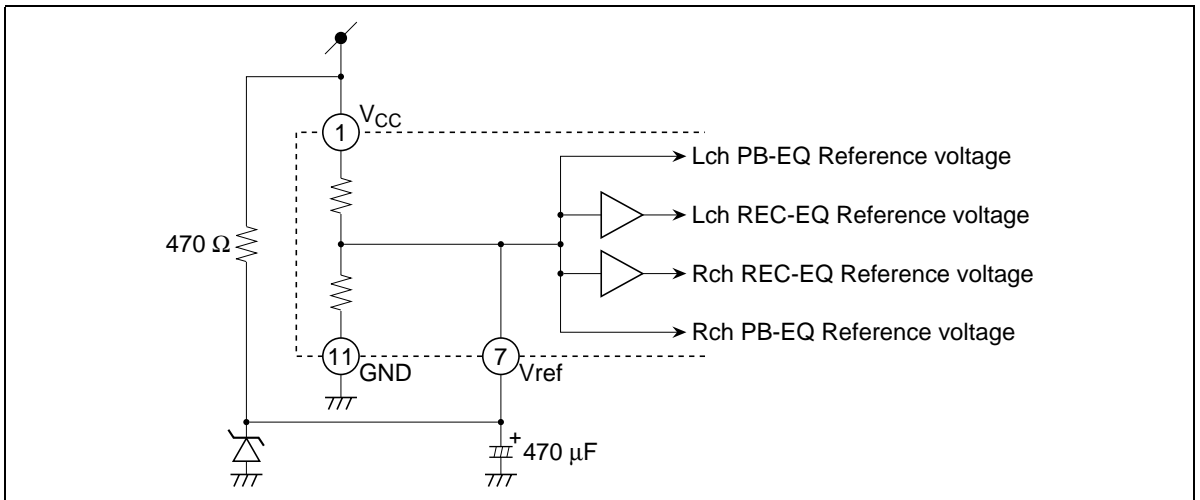

**Figure 1 Reference Voltage Circuit**

# HA12219NT

## Operating Mode Control

HA12219NT provides fully electronic switching circuits. And each operating mode control is controlled by parallel data (DC voltage).

Table 2 shows the control voltage of each control input pin.

**Table 2 Control Voltage (Vth)**

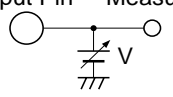
Pin No.	Lo	Mid	Hi	Unit	Test Condition
18, 20	0.0 to 0.5	—	2.4 to $V_{cc}$	V	Input Pin Measure 
19	0.0 to 0.5	1.2 to 1.8	2.4 to $V_{cc}$	V	

- Note:
- Each pin is pulled down with 100 k $\Omega$  internal resistor. 16 to 18 pins are low-level when each pin is open.
  - Over shoot level and under shoot level of input signal must be the standardized.  
(High: Less than  $V_{cc}$ , Low: More than  $-0.2$  V)

## Block Diagram

Figure 2 shows the block diagram.

As this IC is built-in REC return switch, the configuration system can be simple system using a few external component and the REC/PB head.

About these logics, please look at the Parallel Data Format.

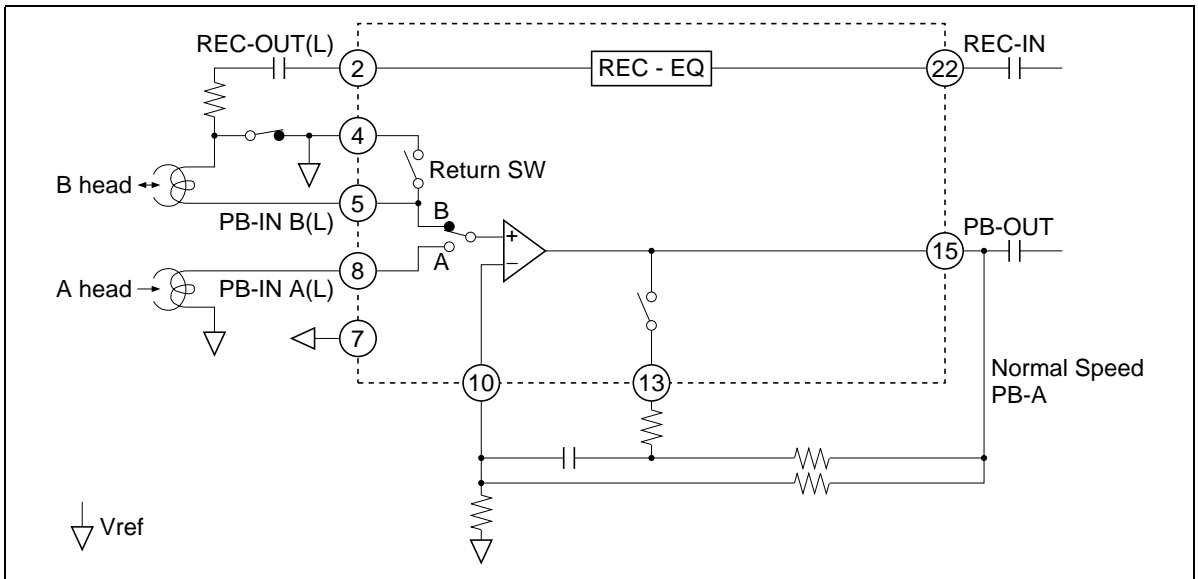

**Figure 2 Block Diagram (Lch)**



**Level Block Diagram**

The gain establishment of PB-EQ considers PB output level  
 {(external AMP+PB AMP <HA12136A>) = 580 mV (Dolby Level)} like figure 3 as the target.

Regarding REC-EQ adjust the gain in front of input to this IC.

Similarly to PB, it consider Dolby level as a standard. And R1 needs the value more than 5.6 kΩ.

Because mode establishment resistances are built-in, REC-EQ frequency characteristics are respectively fixed value.

In case the change of the frequency characteristics are necessary, please inquire the responsible agent because the adjustment of resistors is necessary.

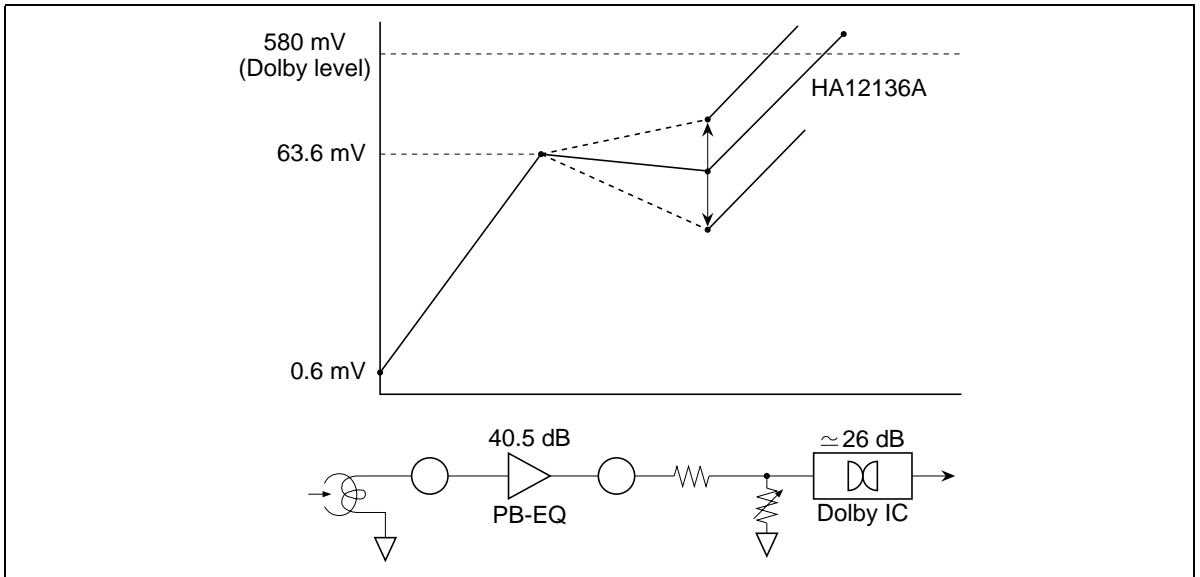

**Figure 3 PB Level Block Diagram (120 μs, 1 kHz)**

---

# HA12219NT

---

## Absolute Maximum Ratings (Ta = 25°C)

Item	Symbol	Rating	Unit	Note
Maximum supply voltage	V <sub>CC</sub> max	16	V	
Power dissipation	P <sub>T</sub>	500	mW	Ta ≤ 75°C
Operating temperature	T <sub>opr</sub>	-40 to +75	°C	
Storage temperature	T <sub>stg</sub>	-55 to +125	°C	
Operating voltage	V <sub>opr</sub>	9.5 to 15	V	

Note: HA12219NT operates on single supply voltage.

**Electrical Characteristics** (Ta = 25°C, V<sub>CC</sub> = 12 V, V<sub>ref</sub> = 5.6 V, PBIN standard level = 0.6 mVrms at 1 kHz)

Item	Symbol	Min	Typ	Max	Unit	Test Condition						Application Terminal			
						IC Condition			f <sub>in</sub> (Hz)	V <sub>in</sub> (mVrms)	Other	Input		Output	
						A/B	B //IIA	120/70				R	L	R	L
Quiescent current	I <sub>Q</sub>	—	23.1	32.7	mA	A	I	70	—	—	No signal			1	
Logical threshold	V <sub>IL</sub>	-0.2	—	0.5	V	—	—	—	—	—	—			18, 20	
	V <sub>IM</sub>	1.2	—	1.8	V	—	—	—	—	—	—			19	
	V <sub>IH</sub>	2.4	—	V <sub>CC</sub>	V	—	—	—	—	—	—			18, 20	
	PB-REC crosstalk	CT PB/REC(1) CT PB/REC(2)	50.0 60.0	60.0 70.0	—	dB	A/B	I	120	1k	*1	REC-EQ → PB-EQ PB-EQ → REC-EQ	21	22	14
PB-EQ gain	G <sub>V</sub> PB(1)	37.5	40.5	43.5	dB	A/B	I	120	1k	0.6	—	9/6	8/5	14	15
	G <sub>V</sub> PB(2)	33.2	36.2	39.2	dB	A/B	I	120	10k	0.6	—	9/6	8/5	14	15
	G <sub>V</sub> PB(3)	29.0	32.0	35.0	dB	A/B	II	70	10k	0.6	—	9/6	8/5	14	15
PB-EQ maximum output *2	V <sub>omax</sub> PB	0.3	0.6	—	Vrms	A/B	I	120	1k	—	THD=1%	9/6	8/5	14	15
PB-EQ THD	THD PB	—	0.1	0.5	%	A/B	I	120	1k	0.6	—	9/6	8/5	14	15
PB-EQ noise voltage	V <sub>N</sub> PB	—	90.0	180.0	μVrms	A/B	I	120	—	—	Rg=820Ω, DIN-AUDIO	9/6	8/5	14	15
	channel separation	CT R/L(1)	50.0	60.0	—	dB	A/B	I	120	1k	*1	8/5	9/6	14	15
PB-EQ crosstalk	CT A/B	60.0	70.0	—	dB	A	I	120	1k	*1	—	6	5	14	15
						B						9	8		

Note: 1. Large level without clipping.  
2. V<sub>CC</sub> = 9.5 V, V<sub>ref</sub> = 4.75 V

**Electrical Characteristics** ( $T_a = 25^\circ\text{C}$ ,  $V_{CC} = 12\text{ V}$ ,  $V_{ref} = 5.6\text{ V}$ ,  
EQIN standard level = 20 dBs = 77.5 mVrms = 0 dB) (cont)

Item	Symbol	Min	Typ	Max	Unit	Test Condition						Application Terminal			
						IC Condition			fin (Hz)	Vin (mVrms)	Other	Input		Output	
						A/B	B //IIA	120/70				R	L	R	L
REC-EQ frequency response TYPE I	$G_V$ REC-NN1	18.5	20.0	21.5	dB	A	I	120	1k	7.75		21	22	3	2
	$G_V$ REC-NN2	19.4	21.4	23.4	dB	A	I	120	5k	7.75		21	22	3	2
	$G_V$ REC-NN3	29.1	32.1	35.1	dB	A	I	120	12.5k	7.75		21	22	3	2
REC-EQ frequency response TYPE II	$G_V$ REC-NC1	22.3	23.8	25.3	dB	A	II	120	1k	7.75		21	22	3	2
	$G_V$ REC-NC2	24.7	26.7	28.7	dB	A	II	120	5k	7.75		21	22	3	2
	$G_V$ REC-NC3	33.6	36.6	39.6	dB	A	II	120	12.5k	7.75		21	22	3	2
REC-EQ channel separation	CT R/L(2)	61.0	70.0	—	dB	A	I	120	1k	*1		21	22	3	2
REC-MUTE attenuation	R-MUTE ATT	66.0	76.0	—	dB	MID	I	120	1k	*1		21	22	3	2
REC-EQ maximum output *2	Vomax REC	1.2	1.8	—	Vrms	A	I	120	1k	—	THD=1%	21	22	3	2
REC-EQ THD	THD REC	—	0.2	0.5	%	A	I	120	1k	77.5		21	22	3	2
REC-EQ S/N	S/N REC	61.0	64.0	—	dB	A	I	120	1k	—	Rg=5.1k $\Omega$ , A-WTG	21	22	3	2

Note: 1. Large level without clipping  
2.  $V_{CC} = 9.5\text{ V}$ ,  $V_{ref} = 4.75\text{ V}$

Test Circuit

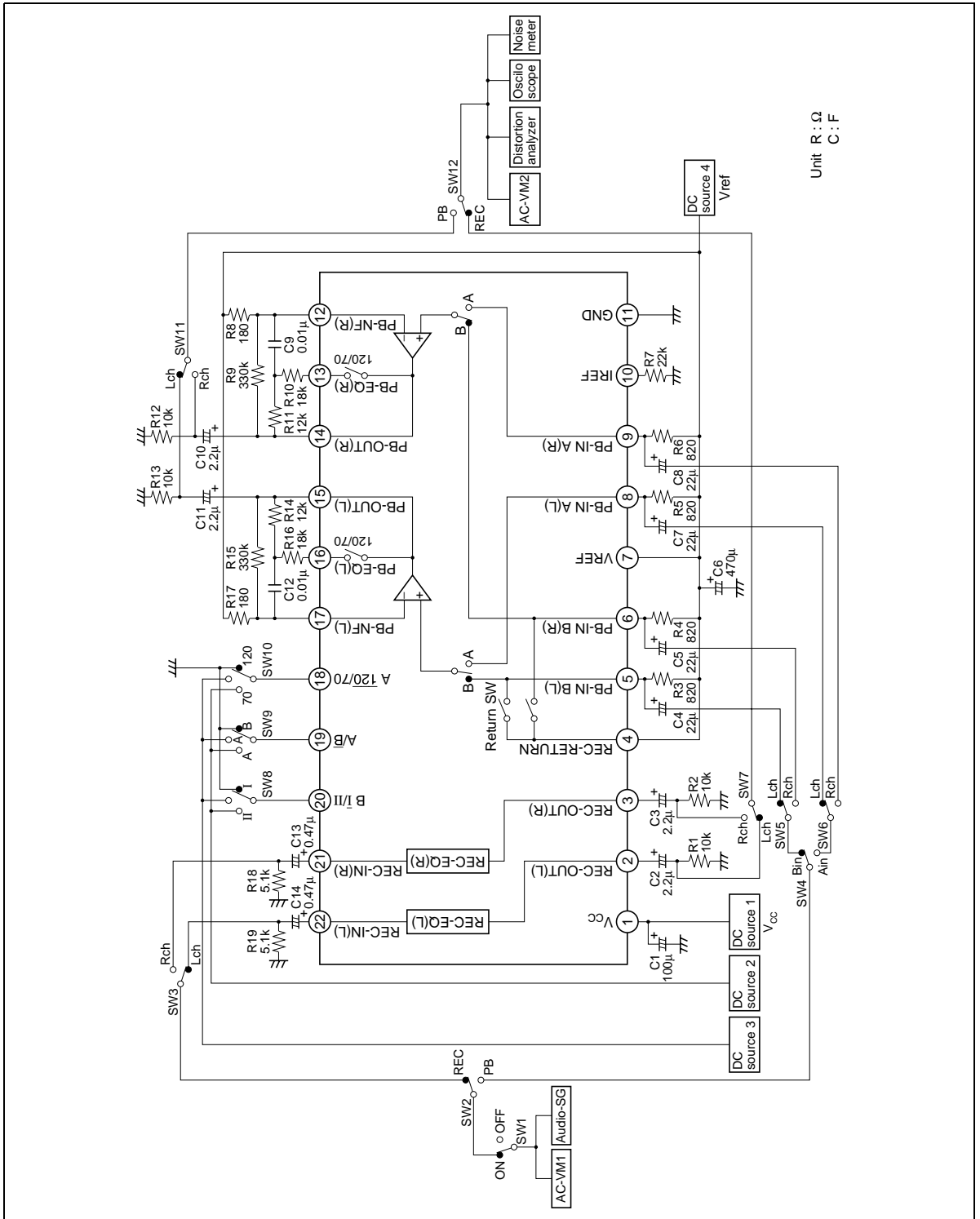

Unit R : Ω  
C : F

## Characteristic Curves

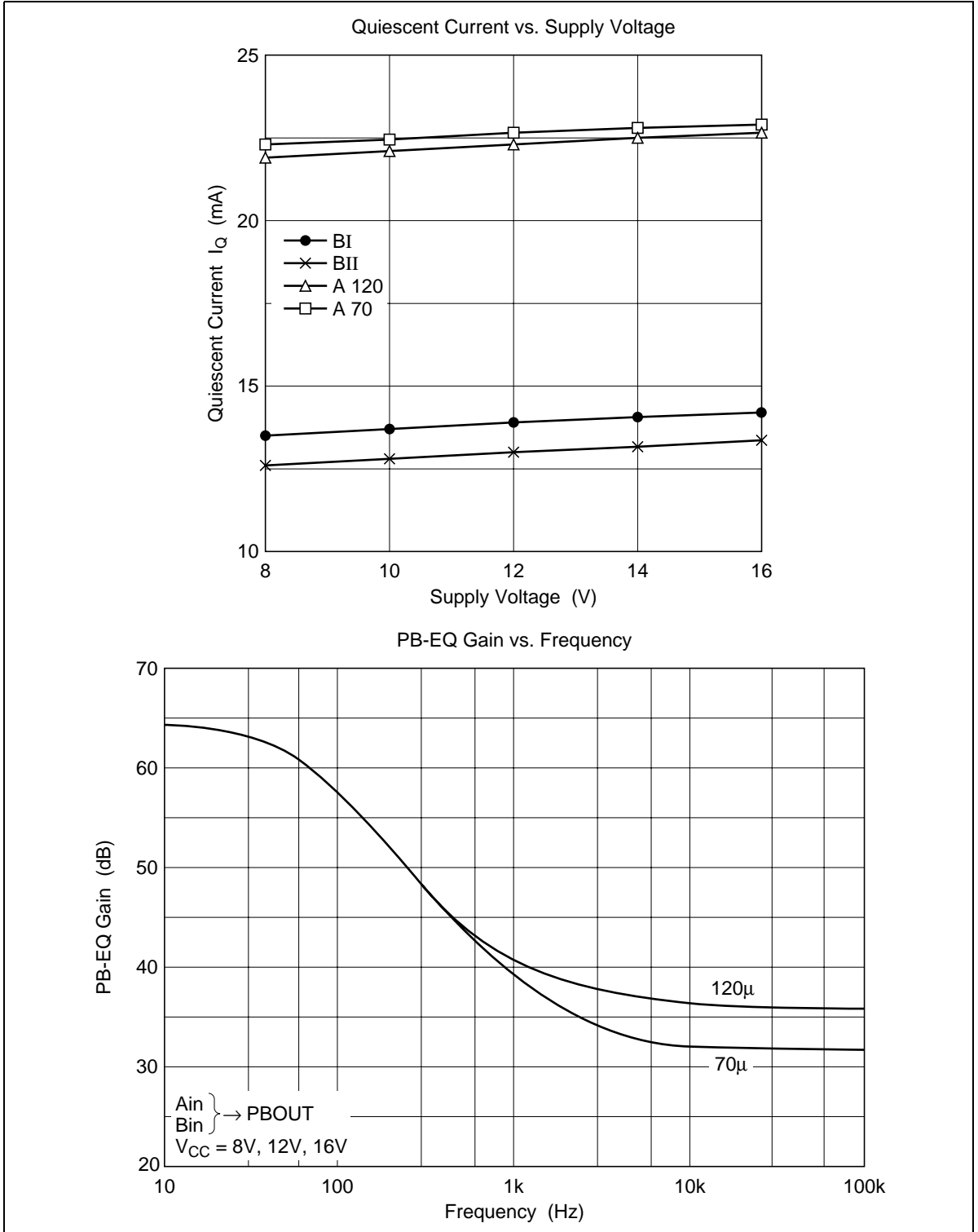

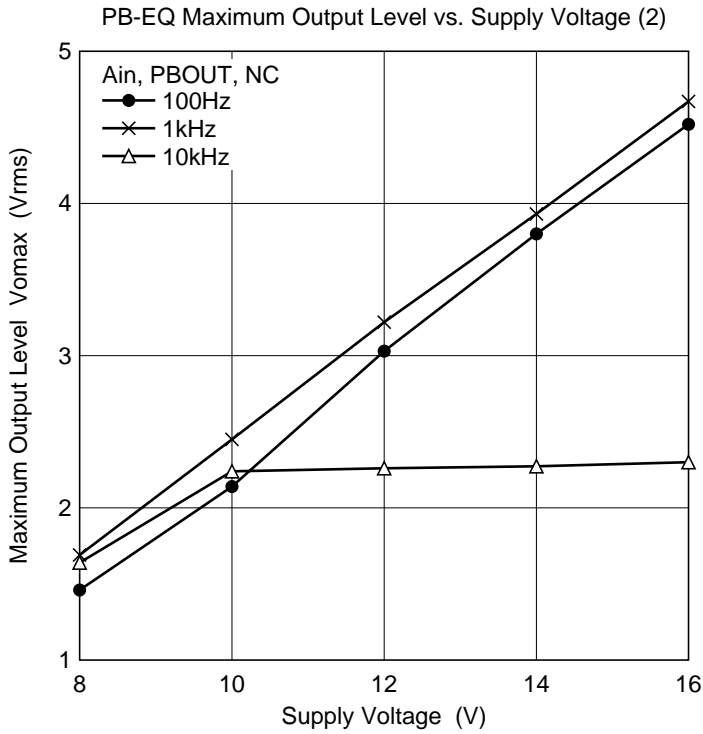
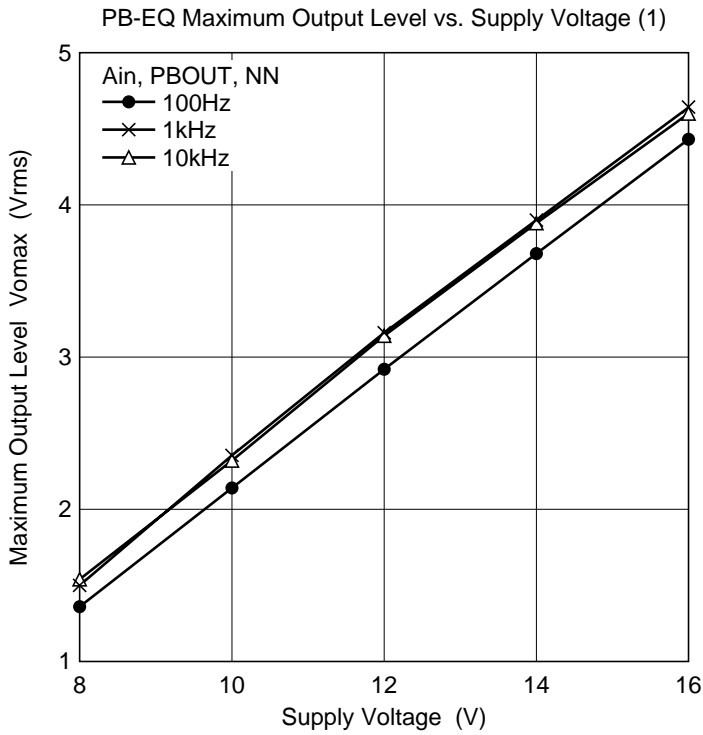

PB-EQ Total Harmonic Distortion vs. Output Level (1)

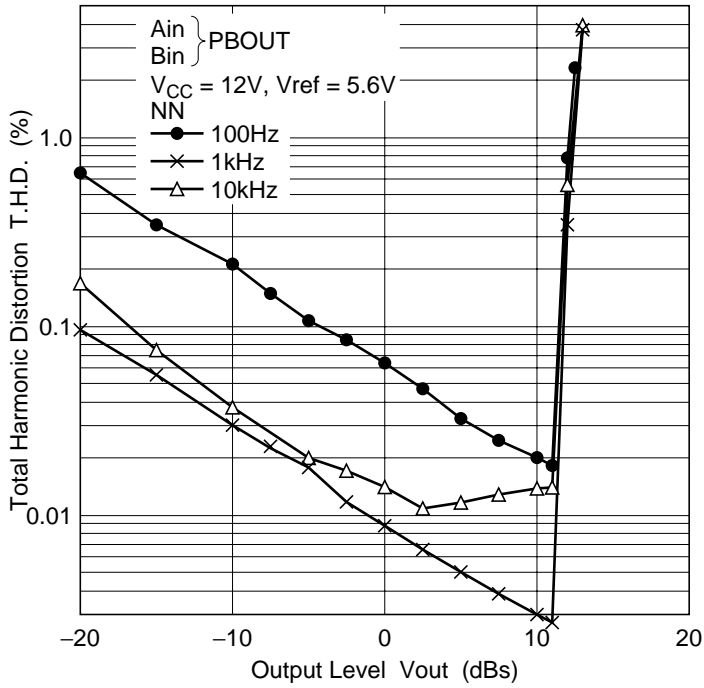

PB-EQ Total Harmonic Distortion vs. Output Level (2)

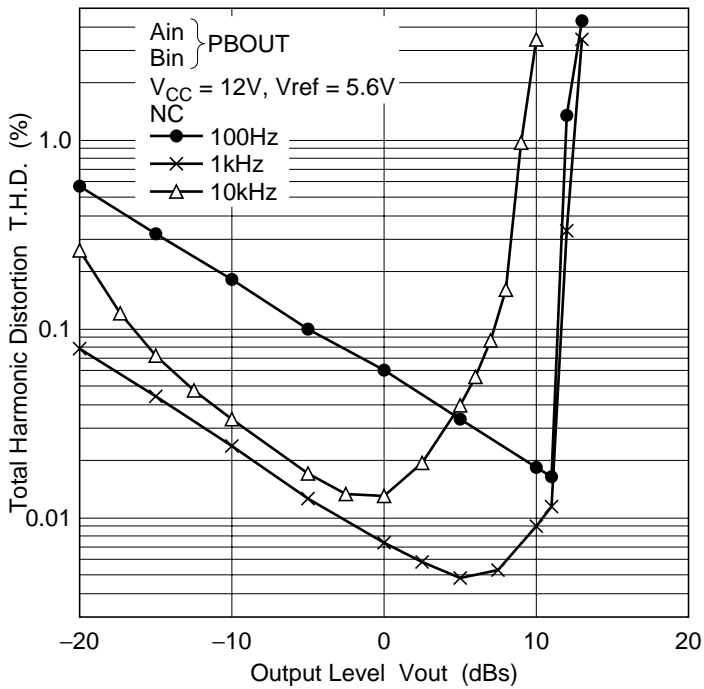



PB-EQ Noise Level vs. Supply Voltage (1)

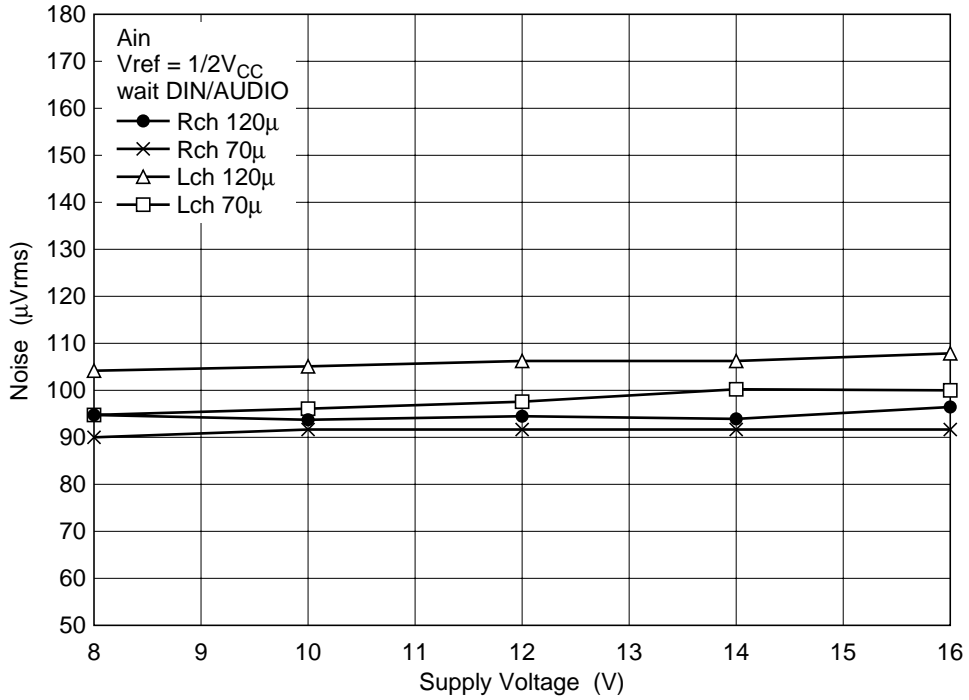

PB-EQ Noise Level vs. Supply Voltage (2)

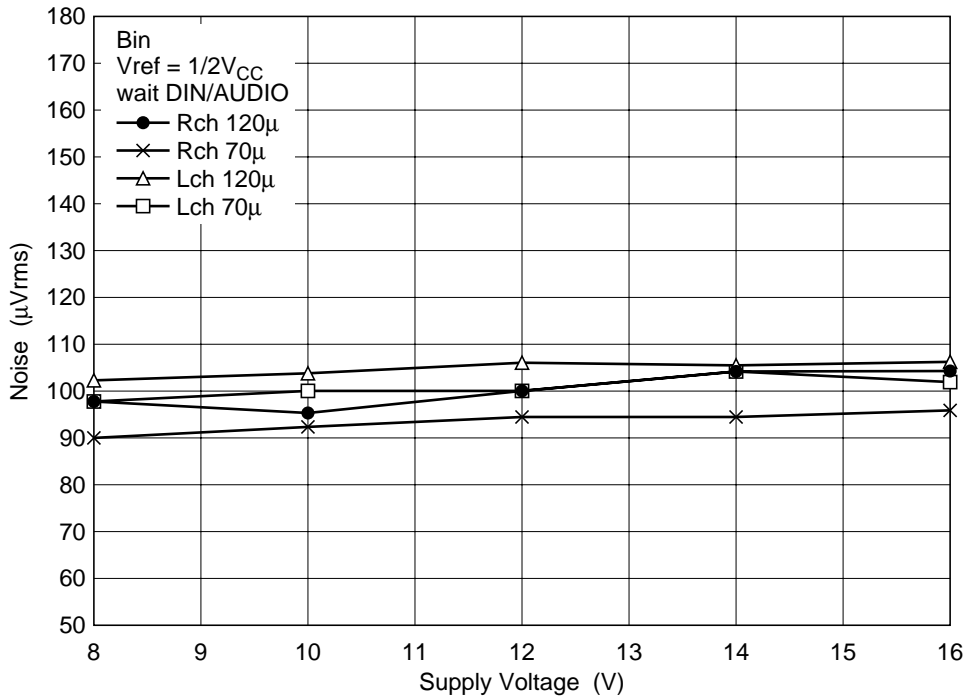

REC-EQ Gain vs. Frequency

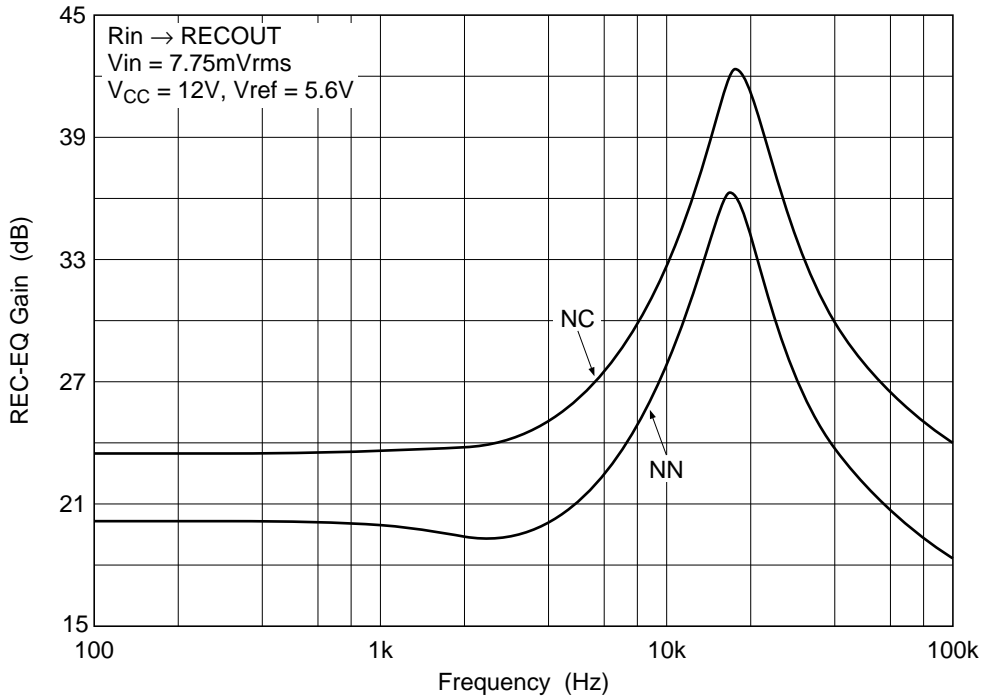

REC-EQ Maximum Output Level vs. Supply Voltage (1)

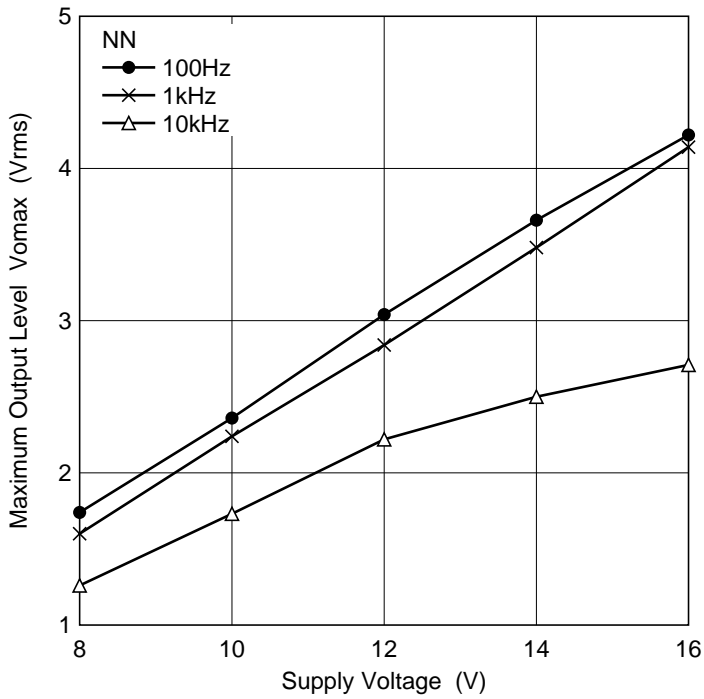

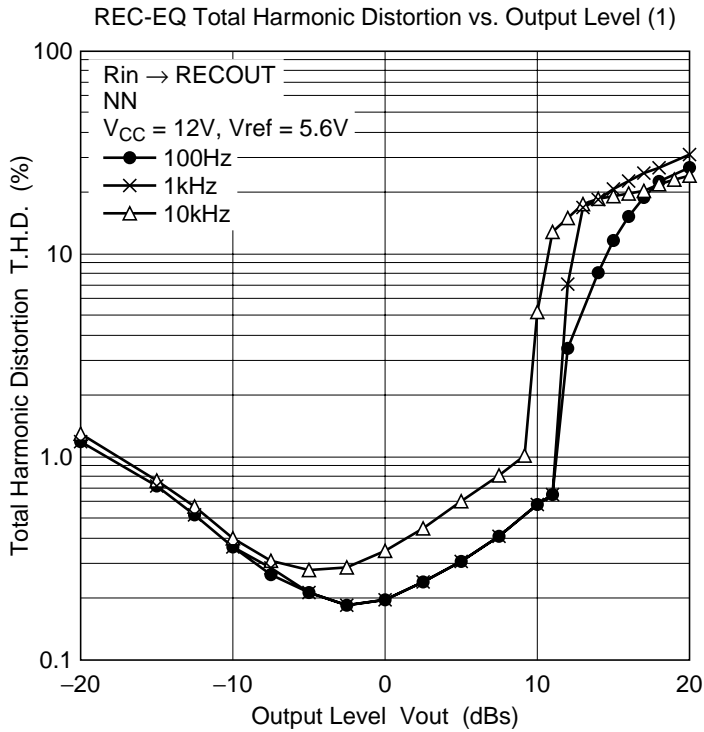
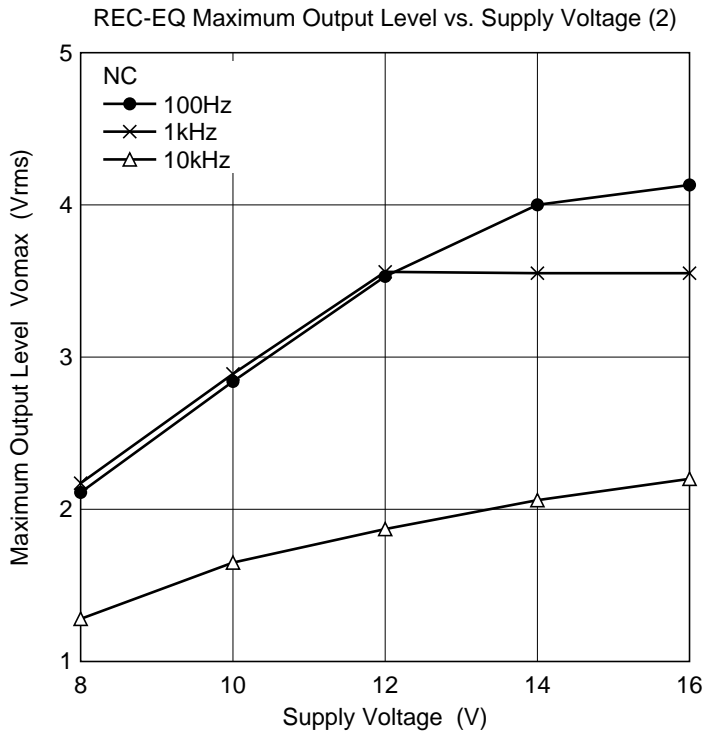

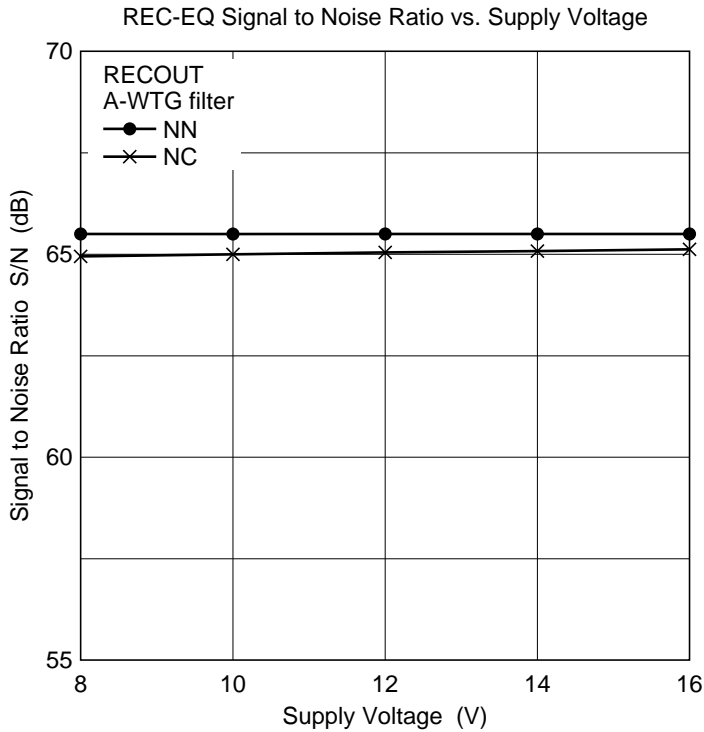
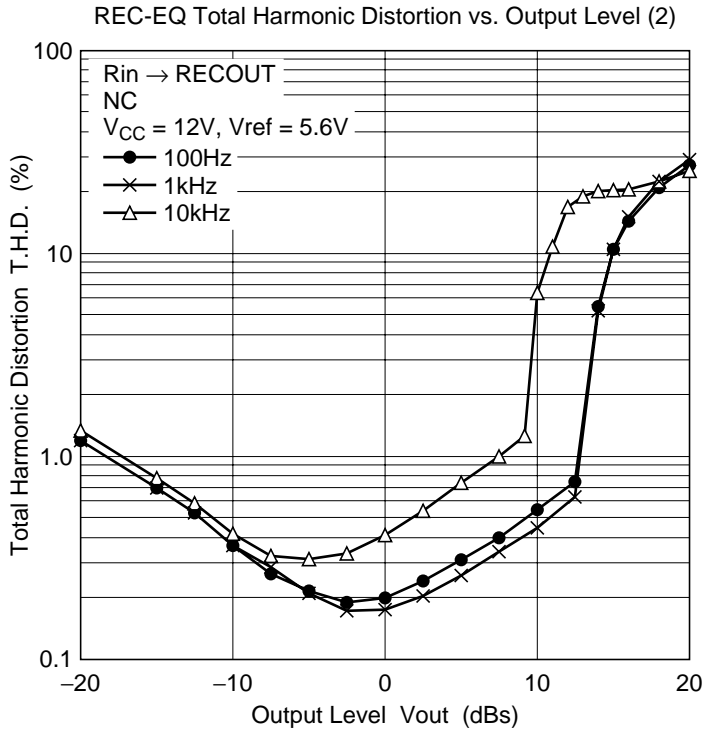

PB-EQ Channel Separation vs. Frequency (L ↔ R) (1)

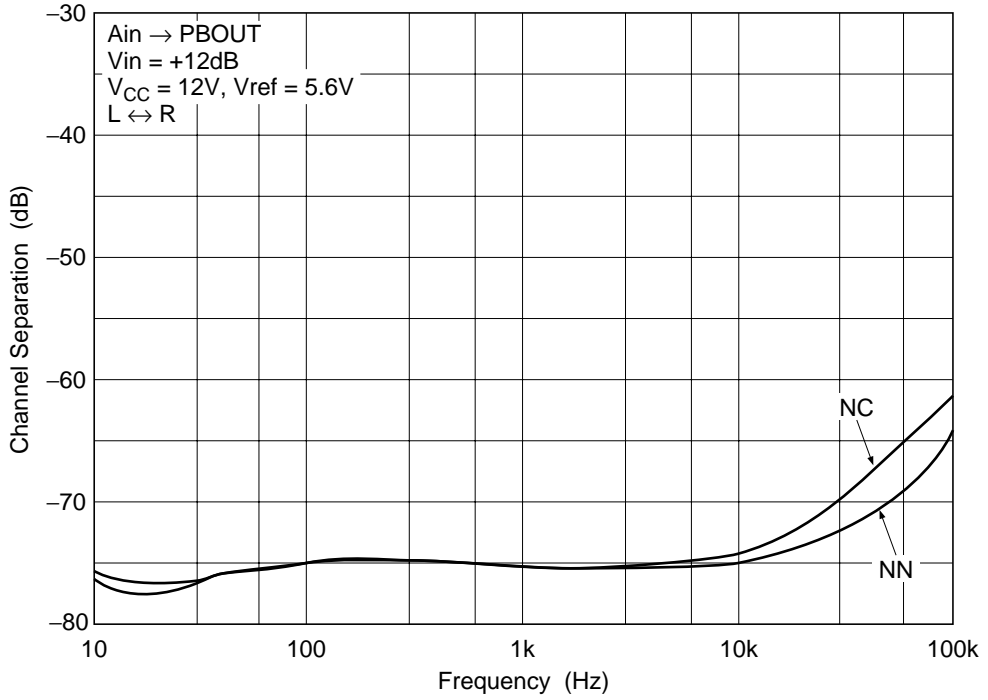

PB-EQ Channel Separation vs. Frequency (L ↔ R) (2)

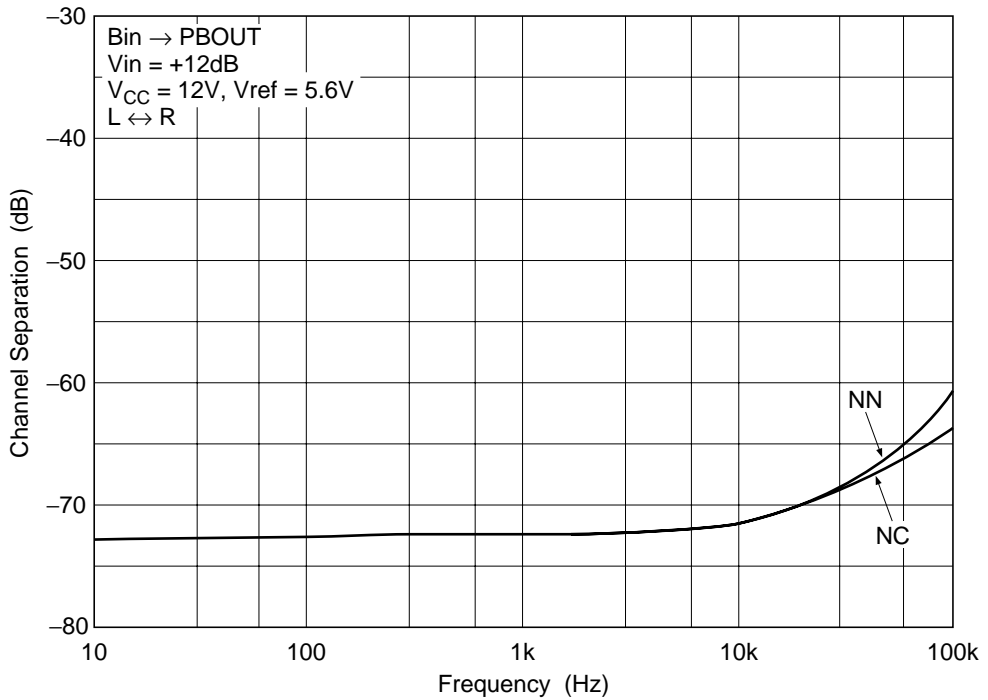

PB-EQ Crosstalk vs. Frequency (Input: Ain → Bin)

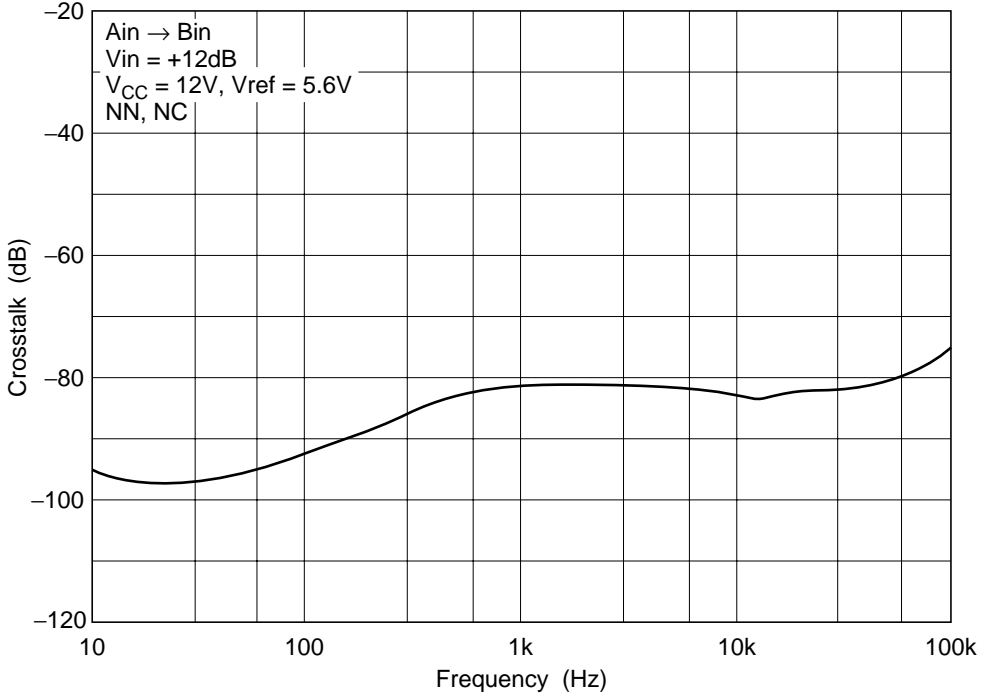

PB-EQ Crosstalk vs. Frequency (Input: Bin → Ain)

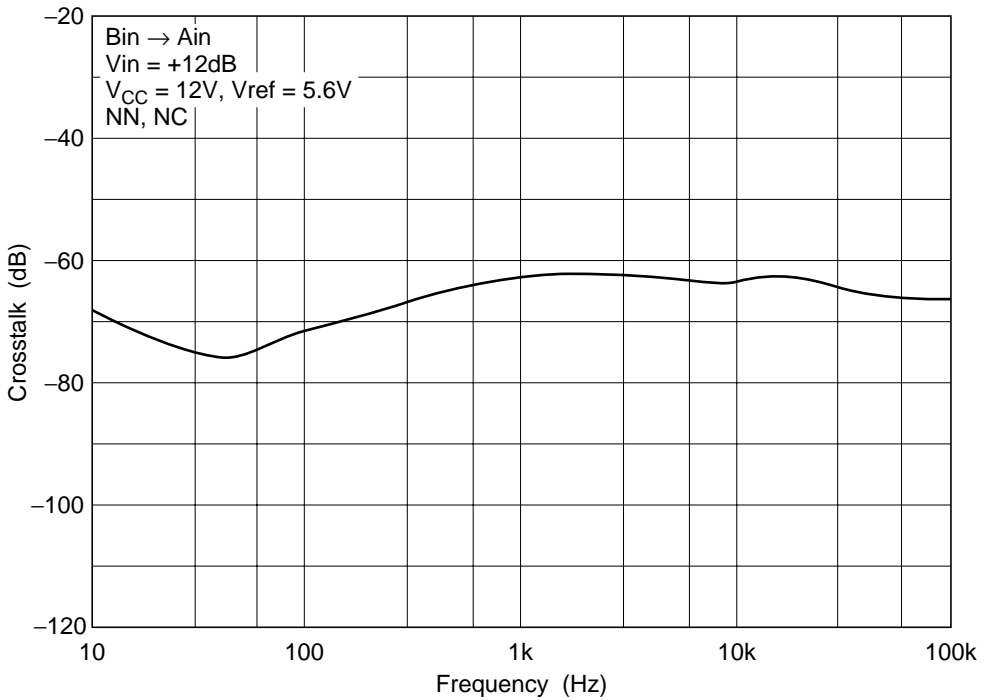

Ripple Rejection Ratio vs. Frequency (REC)

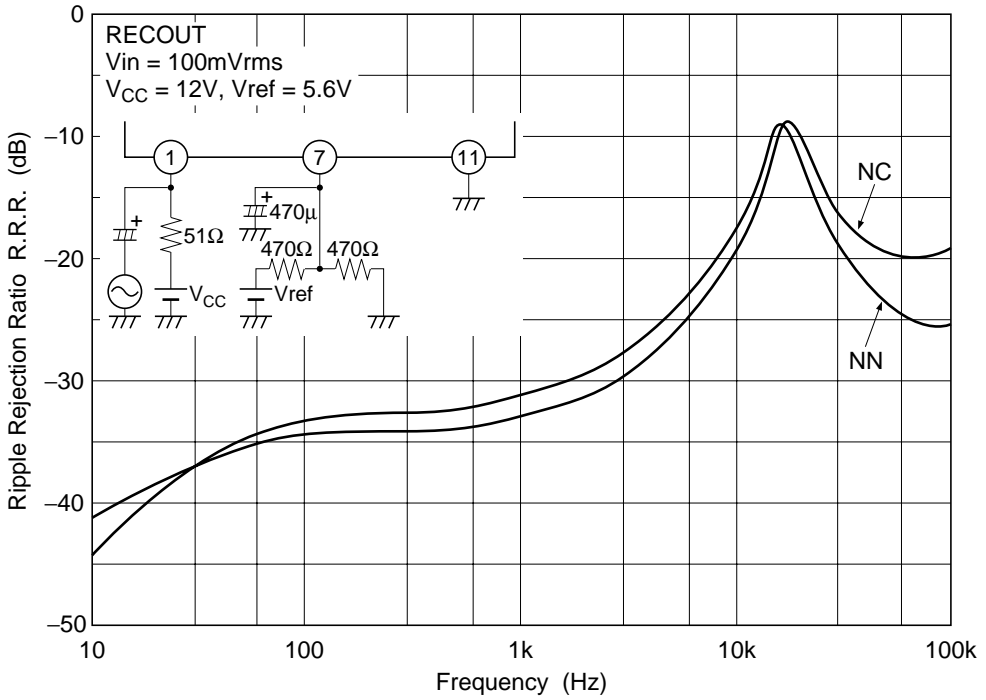

Ripple Rejection Ratio vs. Frequency (PB)

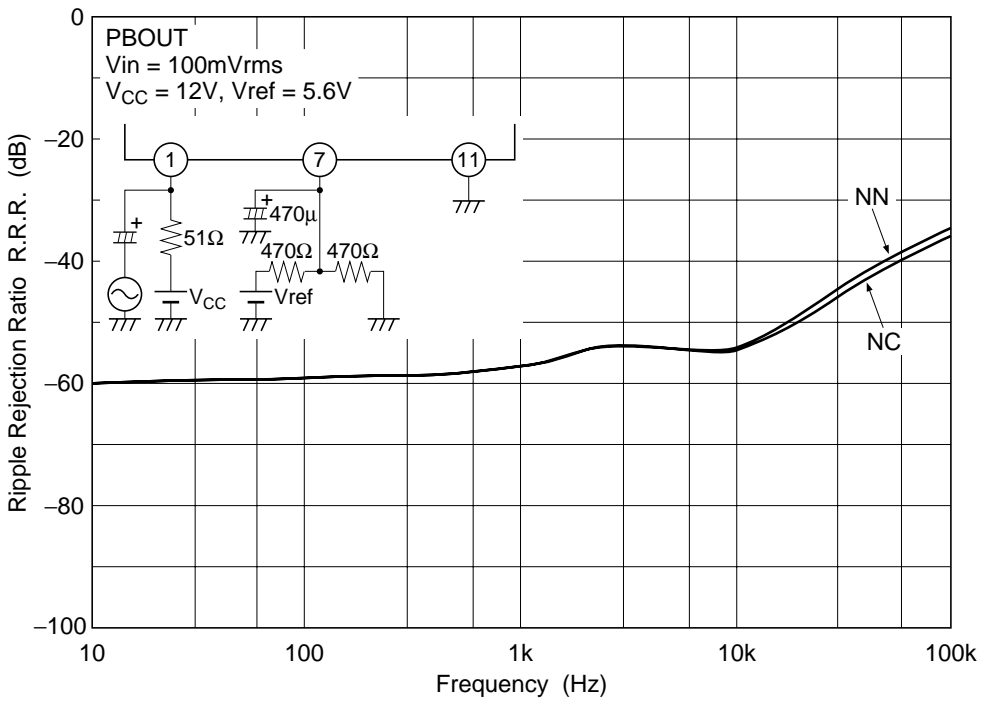

### Mute Attenuation vs. Frequency

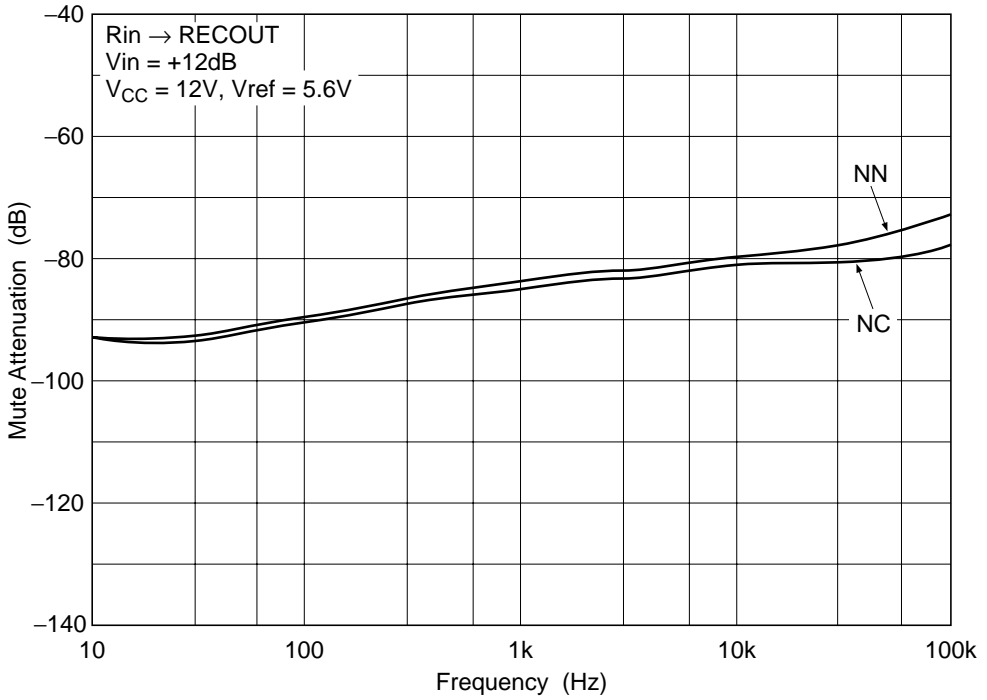

### REC-EQ Channel Separation vs. Frequency (R → L)

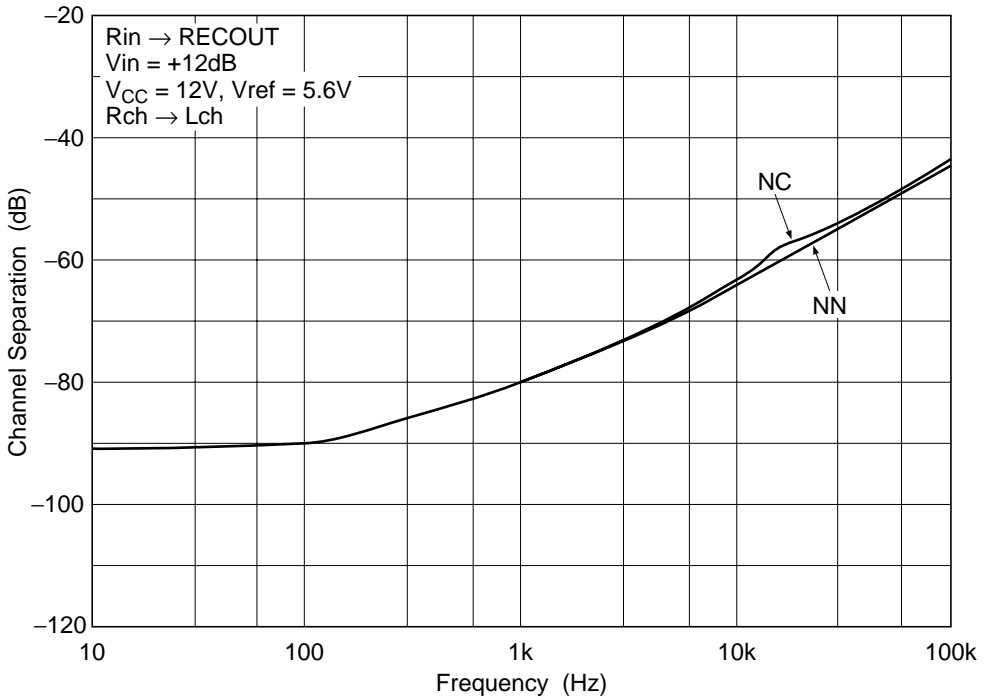



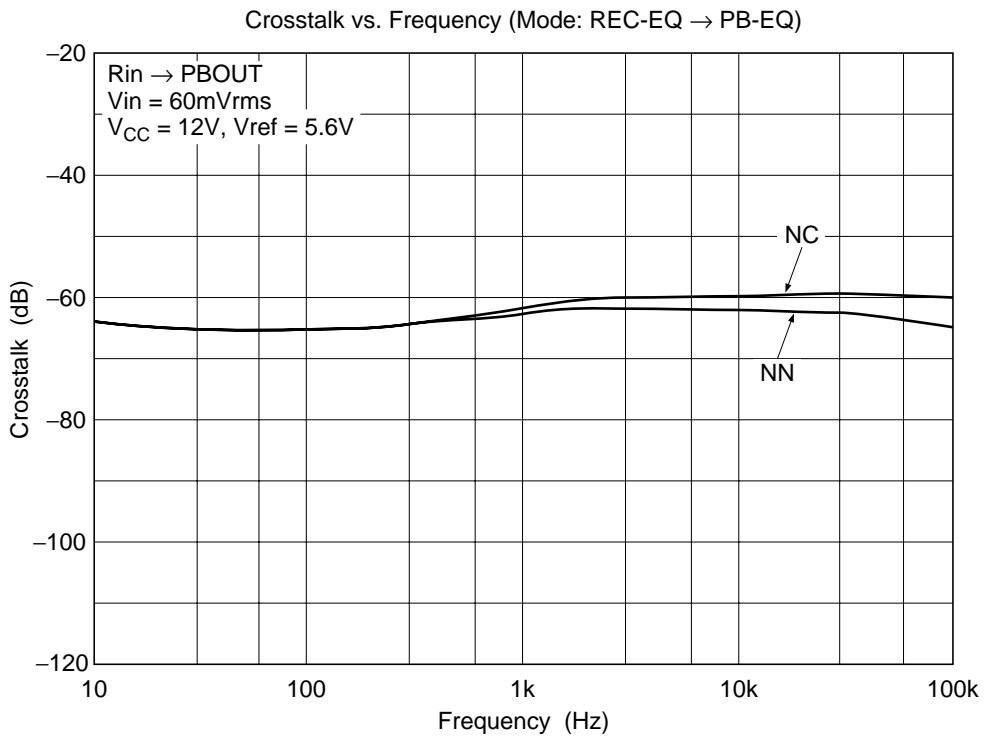
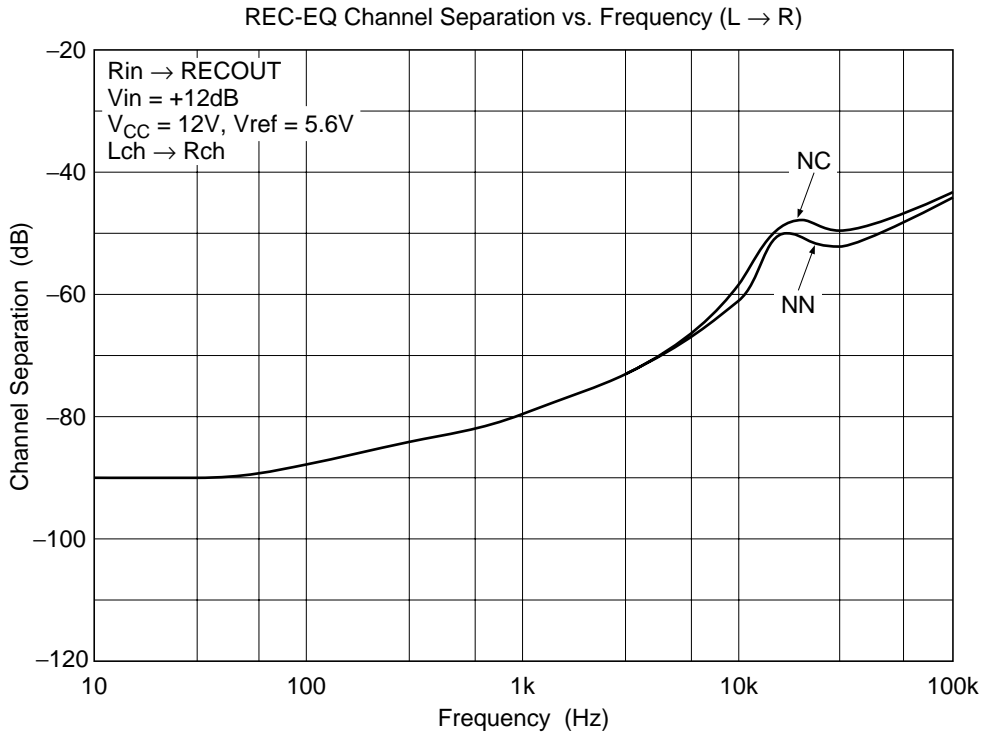

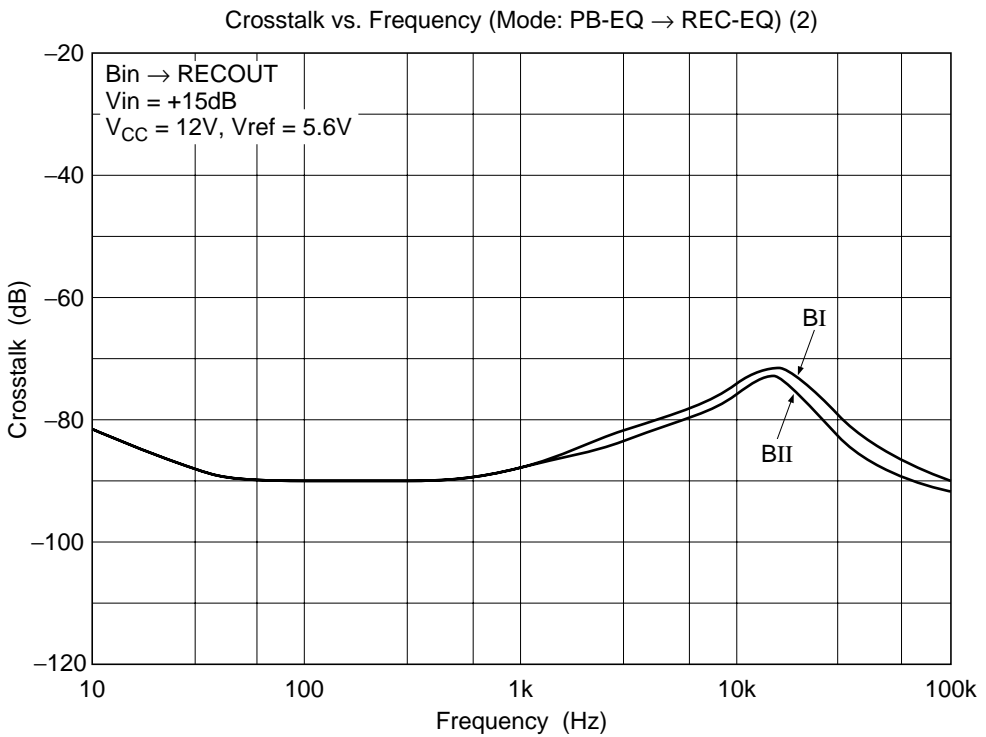
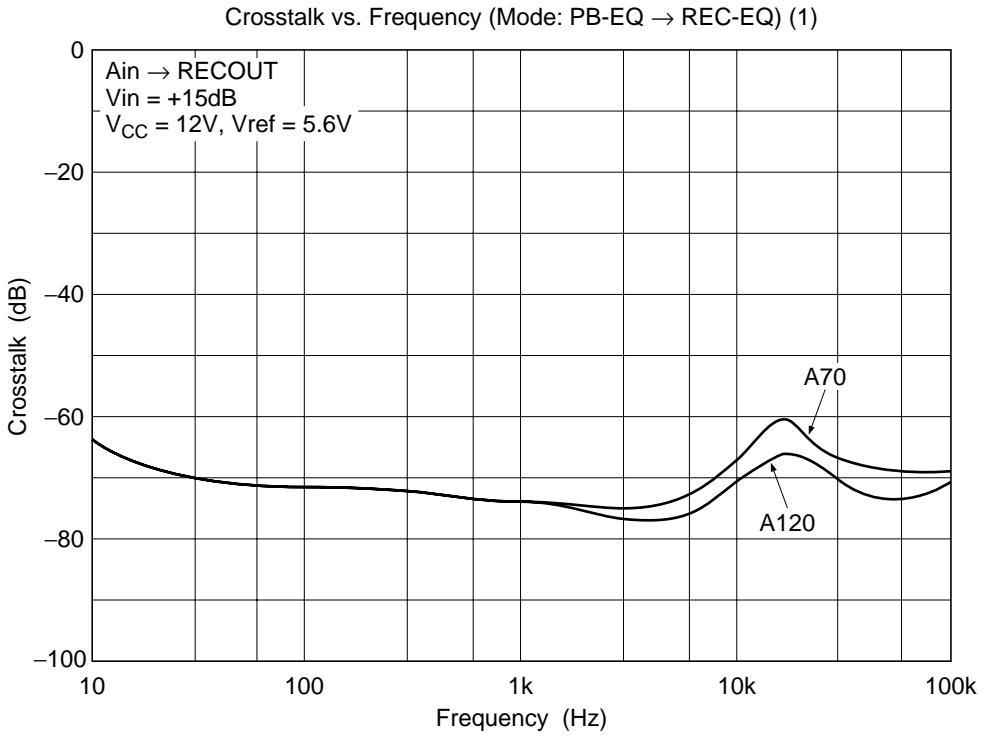

Altered Reference Voltage vs. External Resistance

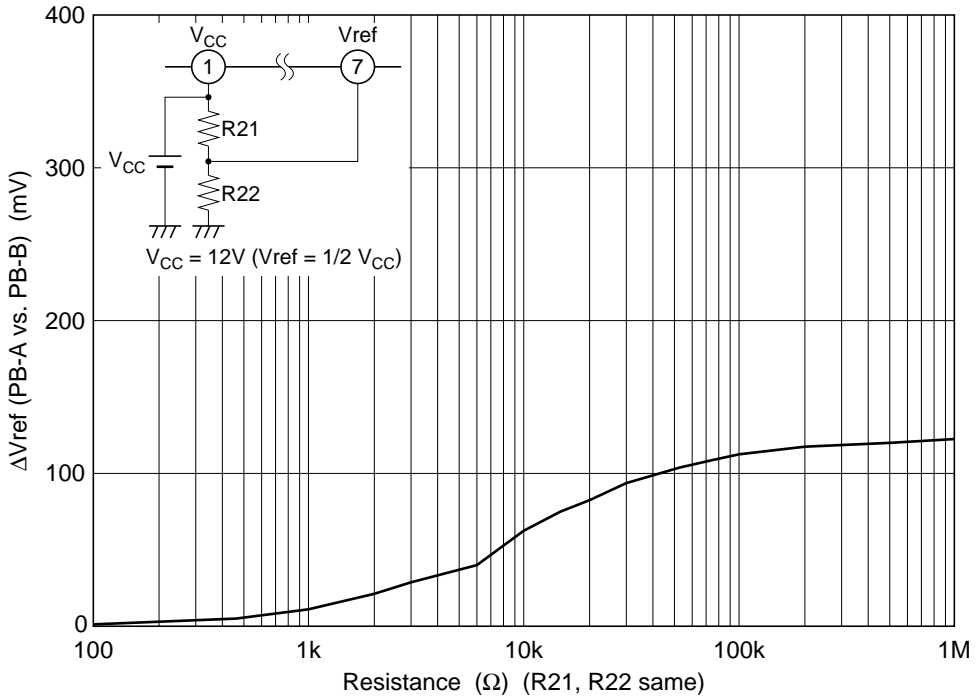

RETURN Level vs. Frequency

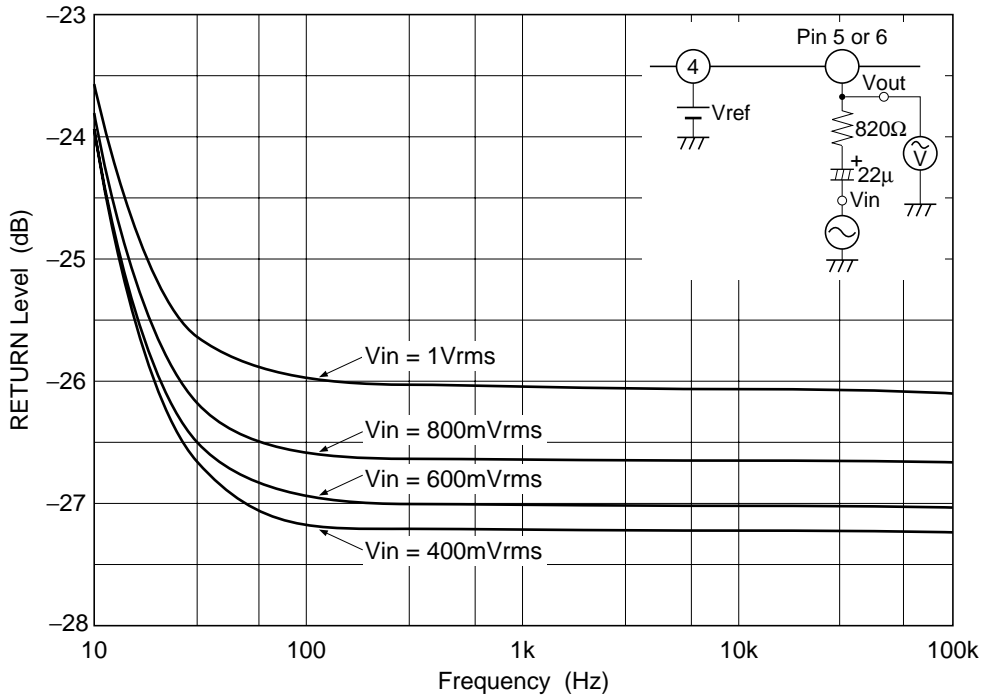

# HA12219NT

## Package Dimensions

Unit: mm

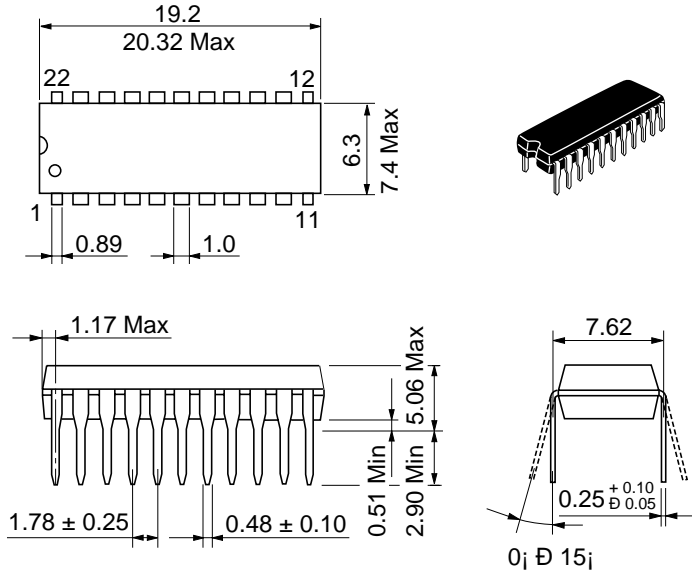

Hitachi Code	DP-22NS
JEDEC	Ñ
EIAJ	Conforms
Weight (reference value)	0.90 g

**Disclaimer**

1. Hitachi neither warrants nor grants licenses of any rights of Hitachi's or any third party's patent, copyright, trademark, or other intellectual property rights for information contained in this document. Hitachi bears no responsibility for problems that may arise with third party's rights, including intellectual property rights, in connection with use of the information contained in this document.
2. Products and product specifications may be subject to change without notice. Confirm that you have received the latest product standards or specifications before final design, purchase or use.
3. Hitachi makes every attempt to ensure that its products are of high quality and reliability. However, contact Hitachi's sales office before using the product in an application that demands especially high quality and reliability or where its failure or malfunction may directly threaten human life or cause risk of bodily injury, such as aerospace, aeronautics, nuclear power, combustion control, transportation, traffic, safety equipment or medical equipment for life support.
4. Design your application so that the product is used within the ranges guaranteed by Hitachi particularly for maximum rating, operating supply voltage range, heat radiation characteristics, installation conditions and other characteristics. Hitachi bears no responsibility for failure or damage when used beyond the guaranteed ranges. Even within the guaranteed ranges, consider normally foreseeable failure rates or failure modes in semiconductor devices and employ systemic measures such as fail-safes, so that the equipment incorporating Hitachi product does not cause bodily injury, fire or other consequential damage due to operation of the Hitachi product.
5. This product is not designed to be radiation resistant.
6. No one is permitted to reproduce or duplicate, in any form, the whole or part of this document without written approval from Hitachi.
7. Contact Hitachi's sales office for any questions regarding this document or Hitachi semiconductor products.

**Sales Offices**

**HITACHI**

**Hitachi, Ltd.**

Semiconductor & Integrated Circuits.  
 Nippon Bldg., 2-6-2, Ohte-machi, Chiyoda-ku, Tokyo 100-0004, Japan  
 Tel: Tokyo (03) 3270-2111 Fax: (03) 3270-5109

URL           NorthAmerica           : <http://semiconductor.hitachi.com/>  
                   Europe                    : <http://www.hitachi-eu.com/hel/ecg>  
                   Asia                         : <http://sicapac.hitachi-asia.com>  
                   Japan                        : <http://www.hitachi.co.jp/Sicd/indx.htm>

**For further information write to:**

Hitachi Semiconductor  
 (America) Inc.  
 179 East Tasman Drive,  
 San Jose, CA 95134  
 Tel: <1> (408) 433-1990  
 Fax: <1> (408) 433-0223

Hitachi Europe GmbH  
 Electronic Components Group  
 Dornacher Straße 3  
 D-85622 Feldkirchen, Munich  
 Germany  
 Tel: <49> (89) 9 9180-0  
 Fax: <49> (89) 9 29 30 00  
 Hitachi Europe Ltd.  
 Electronic Components Group.  
 Whitebrook Park  
 Lower Cookham Road  
 Maidenhead  
 Berkshire SL6 8YA, United Kingdom  
 Tel: <44> (1628) 585000  
 Fax: <44> (1628) 585160

Hitachi Asia Ltd.  
 Hitachi Tower  
 16 Collyer Quay #20-00,  
 Singapore 049318  
 Tel : <65>-538-6533/538-8577  
 Fax : <65>-538-6933/538-3877  
 URL : <http://www.hitachi.com.sg>

Hitachi Asia Ltd.  
 (Taipei Branch Office)  
 4/F, No. 167, Tun Hwa North Road,  
 Hung-Kuo Building,  
 Taipei (105), Taiwan  
 Tel : <886>-(2)-2718-3666  
 Fax : <886>-(2)-2718-8180  
 Telex : 23222 HAS-TP  
 URL : <http://www.hitachi.com.tw>

Hitachi Asia (Hong Kong) Ltd.  
 Group III (Electronic Components)  
 7/F., North Tower,  
 World Finance Centre,  
 Harbour City, Canton Road  
 Tsim Sha Tsui, Kowloon,  
 Hong Kong  
 Tel : <852>-(2)-735-9218  
 Fax : <852>-(2)-730-0281  
 URL : <http://www.hitachi.com.hk>

Copyright © Hitachi, Ltd., 2000. All rights reserved. Printed in Japan.  
 Colophon 2.0