

HA12231FP

Audio Signal Processor for Car Deck (PB 1 Chip)

HITACHI

ADE-207-327A (Z)
2nd Edition
Jan. 2001

Description

HA12231FP is silicon monolithic bipolar IC providing PB equalizer system and music sensor system in one chip.

Functions

- PB equalizer × 2 channel
- Music sensor × 1 channel
- Line amp. × 2 channel
- Line mute × 2 channel

Features

- No use external parts for PB equalizer. (Fixed characteristics built-in)
- Available to change music sensing level by external resistor.
- Available to change frequency response of music sensor by external capacitor.
- Different type of PB equalizer characteristics selection (120 μ s/70 μ s) is available.
- Line mute ON/OFF is available.
- This IC is strong for a cellular phone noise.

Ordering Information

Product	Package	PBOUT-Level	Functions		
			PB-EQ	Music Sensor	Mute
HA12231FP	FP-20DA	450 mVrms	○	○	○

HA12231FP

Pin Description, Equivalent Circuit ($V_{CC} = 9\text{ V}$, A system of single supply voltage, $T_a = 25^\circ\text{C}$, No Signal, The value in the table shows typical value.)

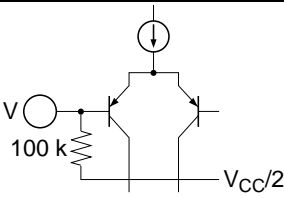
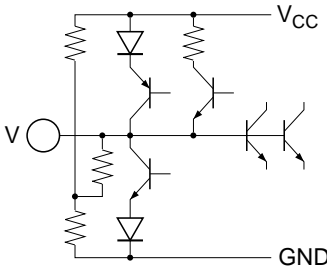
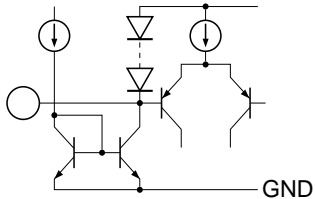
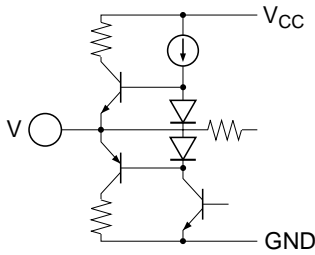
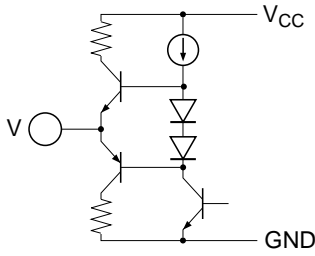
Pin No.	Pin Name	Note	Equivalent Circuit	Description
16	TAI(L)	$V = V_{CC}/2$		Tape input
5	TAI(R)			
14	RIP	$V = V_{CC}/2$		Ripple filter
13	MS DET	$V = V_{CC}$		Time constant pin for rectifier
15	PBOUT(L)	$V = V_{CC}/2$		PB output
6	PBOUT(R)			
1	VREF	$V = V_{CC}/2$		Reference output
17	EQOUT(L)	$V = V_{CC}/2$		Equalizer output (120 μ)
4	EQOUT(R)			

Note: MS: Music Sensor

HITACHI

Pin Description, Equivalent Circuit ($V_{CC} = 9\text{ V}$, A system of single supply voltage, $T_a = 25^\circ\text{C}$, No Signal, The value in the table shows typical value.) (cont.)

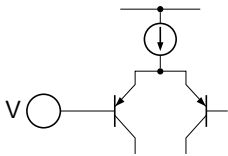
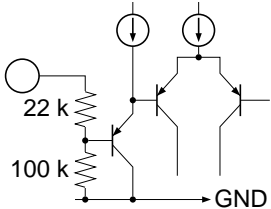
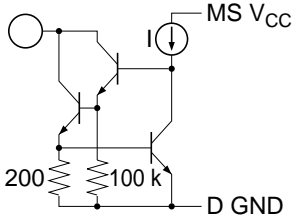
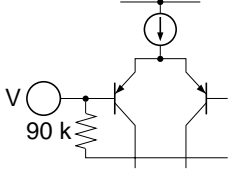
Pin No.	Pin Name	Note	Equivalent Circuit	Description
11	V_{CC}	—		Power supply
19	FIN(L)	—		Equalizer input
18	RIN(L)			
3	RIN(R)			
2	FIN(R)			
9	Mute	—		Mode control input
10	$\overline{\text{FOR/REV}}$			
8	$\overline{\text{I20/70}}$			
12	MS	—		MS output (to MPU) *
7	MS G_v	$V = V_{CC}/2$		MS gain pin *
20	GND	—		GND pin

Note: MS: Music Sensor

Block Diagram

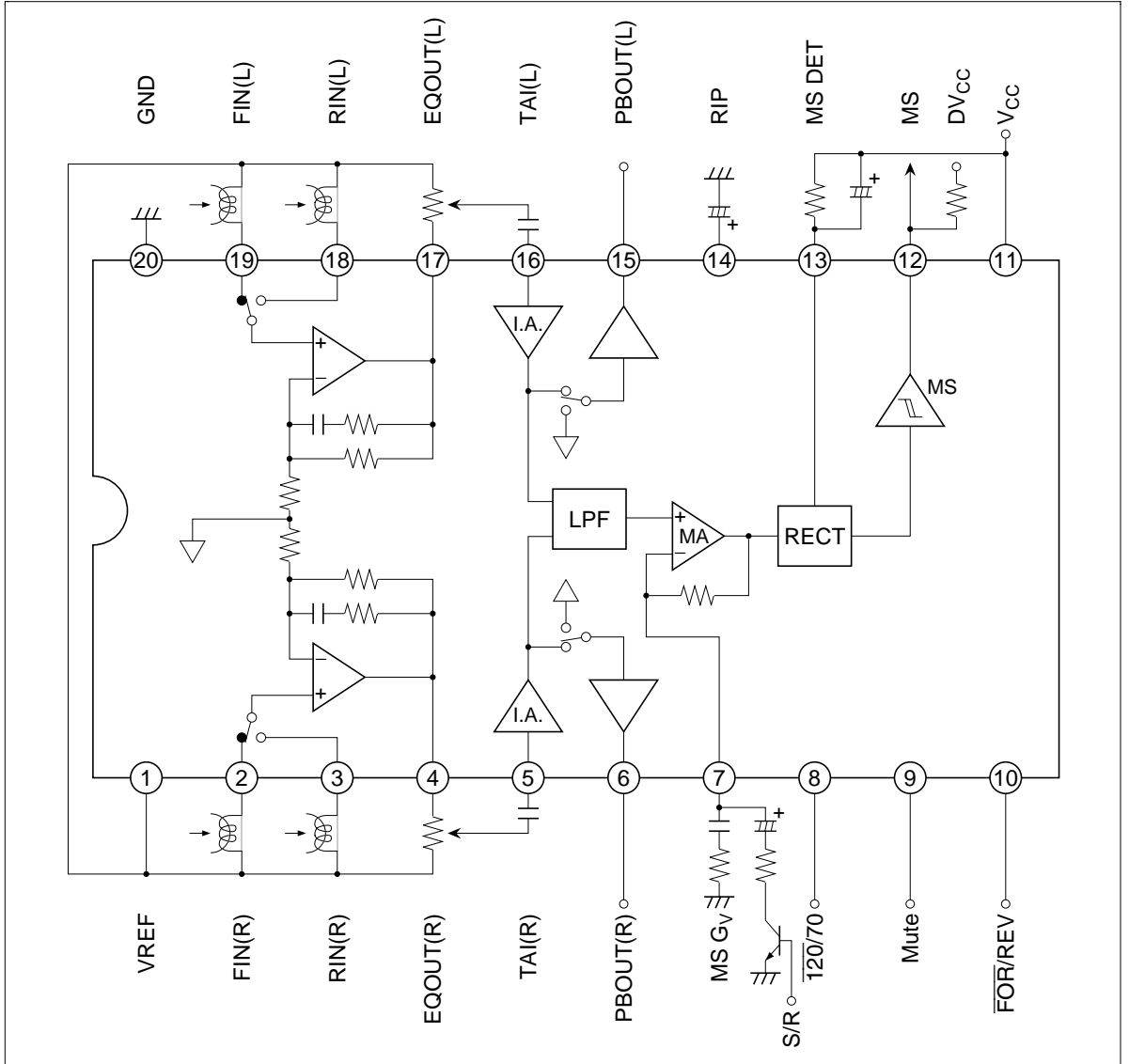

Absolute Maximum Ratings ($T_a = 25^{\circ}\text{C}$)

Item	Symbol	Rating	Unit	Note
Supply voltage	V_{cc} Max	15	V	
Power dissipation	P_d	400	mW	$T_a \leq 85^{\circ}\text{C}$
Operating temperature	T_{opr}	-40 to +85	$^{\circ}\text{C}$	
Storage temperature	T_{stg}	-55 to +125	$^{\circ}\text{C}$	

Electrical Characteristics

(Ta = 25°C, V_{CC} = 9 V, PBOUIT Level = 450 mVrms (= 0 dB))

Item	Symbol	Test Condition										Application Terminal		Re-remark		
		IC Condition			PBOUIT level(dB)			Specification				Input			Output	
		INPUT	OUTPUT	fin(Hz)	PBOUIT level(dB)	Min	Typ	Max	Unit	R	L	R	L			
Quiescent current	I _Q	—	—	—	—	No signal	—	6.0	9	mA	—	—	—	11		
Input AMP. gain	G _V /A	TAI	PBOUIT	1k	0	—	—	22.5	23.5	24.5	dB	5	16	6	15	
Signal handling	Vomax	TAI	PBOUIT	1k	—	THD = 1%	—	12.0	13.0	—	dB	5	16	6	15	
T.H.D.	THD	TAI	PBOUIT	1k	0	—	—	—	0.05	0.3	%	5	16	6	15	
Channel separation	CT RL	FIN	PBOUIT	1k	12	—	—	50.0	60.0	—	dB	2	19	6→15→6	—	
PB-EQ gain	G _V EQ 1k	FIN/RIN	EQOUT	1k	0	120μs	—	37.0	40.0	43.0	dB	2/3	19/18	4	17	
	G _V EQ 10k(1)	FIN	EQOUT	10k	0	120μs	—	33.0	36.0	39.0	dB	2	19	4	17	
	G _V EQ 10k(2)	FIN	EQOUT	10k	0	70μs	—	29.0	32.0	35.0	dB	2	19	4	17	
PB-EQ maximum output	V _{OM}	FIN/RIN	EQOUT	1k	—	THD = 1%	—	300	600	—	mVrms	2/3	19/18	4	17	
PB-EQ THD	THD-EQ	FIN/RIN	EQOUT	1k	0	—	—	—	0.1	0.5	%	2/3	19/18	4	17	
Noise voltage level converted in input	V _N	FIN/RIN	EQOUT	(1k)	(0)	Rg = 680Ω, Din-Audio Filter	—	—	1.2	2.0	μVrms	2/3	19/18	4	17	
MS sensing level	V _{ON}	TAI	PBOUIT MSOUT	5k	—	—	—	-18.0	-14.0	-10.0	dB	5	16	6	15	
MS output low level	V _{OL}	TAI	PBOUIT MSOUT	5k	0	—	—	—	1.0	1.5	V	5	16	6	15	
MS output leak current	I _{OH}	—	MSOUT	—	—	No signal	—	—	0.0	2.0	μA	—	—	12	12	
MUTE attenuation	Mute	TAI	PBOUIT	1k	12	—	—	70.0	80.0	—	dB	5	16	6	15	
Control voltage	V _{IL}	—	—	—	—	—	—	-0.2	—	1.0	V	—	—	—	8, 9,	
	V _{IH}	—	—	—	—	—	—	3.5	—	V _{CC}	—	—	—	—	10	

Note: 1. V_{CC} = 7.2 V

Test Circuit

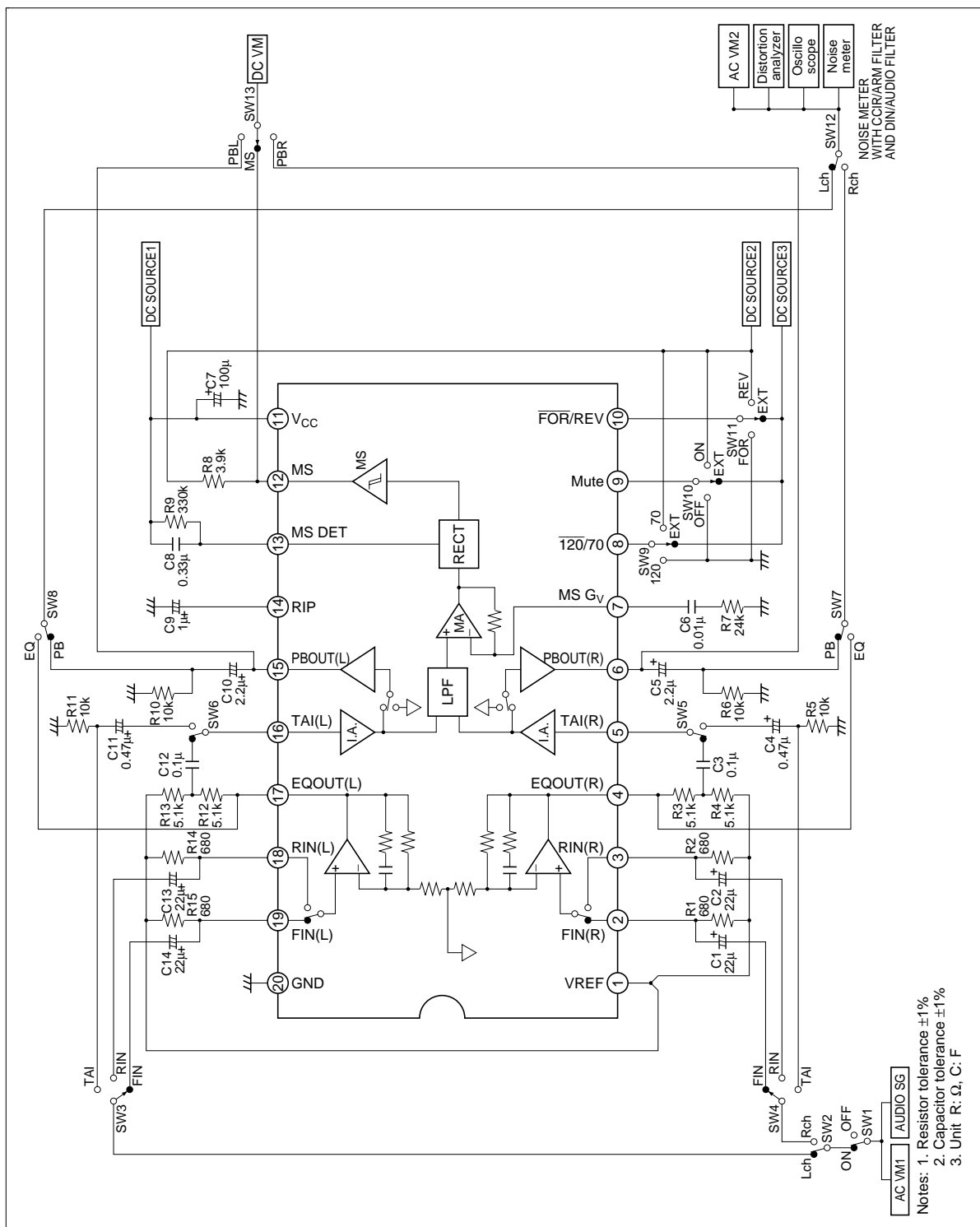

Functional Description

Power Supply Range

HA12231FP is designed to operate on single supply only.

Table 1 Supply Voltage Range

Product	Single Supply
HA12231FP	7.2 V to 12.0 V

Reference Voltage

HA12231FP provides the reference voltage of half the supply voltage that is the signal grounds. As the peculiarity of this device, the capacitor for the ripple filter is very small about 1/100 compared with their usual value. The block diagram is shown as figure 1.

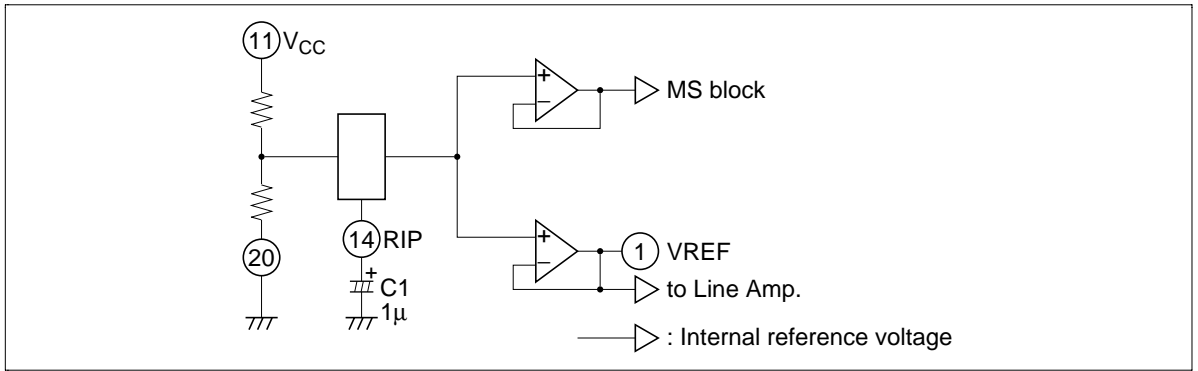

Figure 1 The Block Diagram of Reference Supply Voltage

Operating Mode Control

HA12231FP provides fully electronic switching circuits. And each operating mode control are controlled by parallel data (DC voltage).

When a power supply of this IC is cut off, for a voltage, in addition to a mode control terminal even though as do not destruct it, in series for resistance.

Table 2 Threshold Voltage (V_{TH})

Pin No.	Lo	Hi	Unit	Test Condition
8, 9, 10	-0.2 to 1.0	3.5 to V_{CC}	V	Input Pin Measure 

Table 3 Switching Truth Table

Pin No.	Pin Name	Low	High
8	$\overline{120/70}$	120 μ (Normal)	70 μ (Metal or Chrome)
9	Mute	Mute OFF	Mute ON
10	$\overline{FOR/REV}$	Forward	Reverse

- Notes:
1. Each pins are on pulled down with 100 k Ω internal resistor. Therefore, it will be low-level when each pins are open.
 2. Over shoot level and under shoot level of input signal must be the standardized. (High: V_{CC} , Low: -0.2 V)
 3. Reducing pop noise is so much better for 10 k Ω to 22 k Ω resisor and 1 μ F to 22 μ F capacitor shown figure 2.

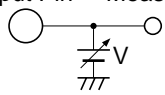
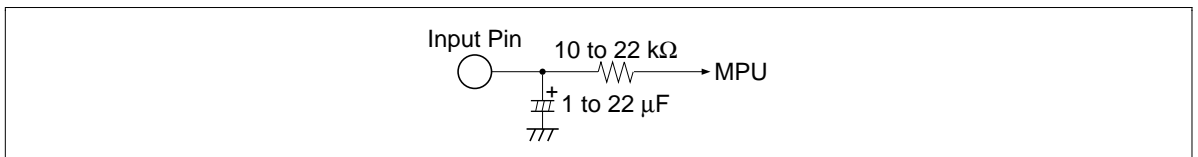

Figure 2 Interface for Reduction of Pop Noise

Input Block Diagram and Level Diagram

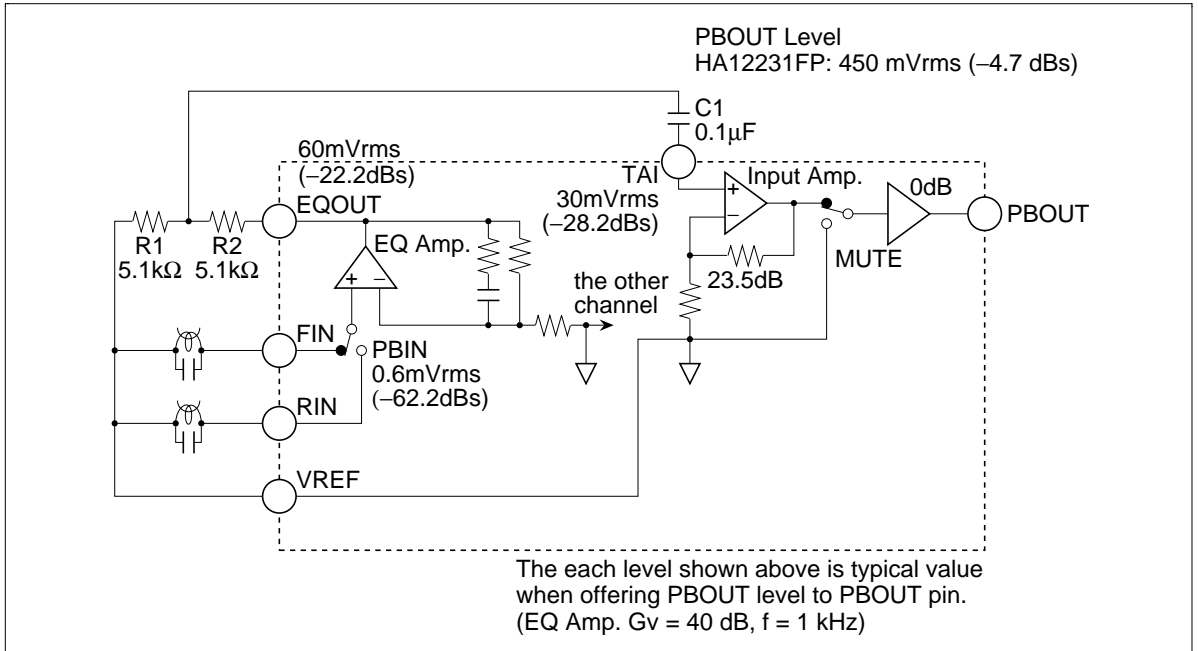

Figure 3 Input Block Diagram

Adjustment of Playback Reference Operate Level

After replace R1 and R2 with a half-fix volume of 10 kΩ, adjust playback reference operate level.

The Sensitivity Adjustment of Music Sensor

Adjusting MS Amp. gain by external resistor, the sensitivity of music sensor can set up. The music sensor block diagram is shown in figure 4, and frequency response is shown in figure 5.

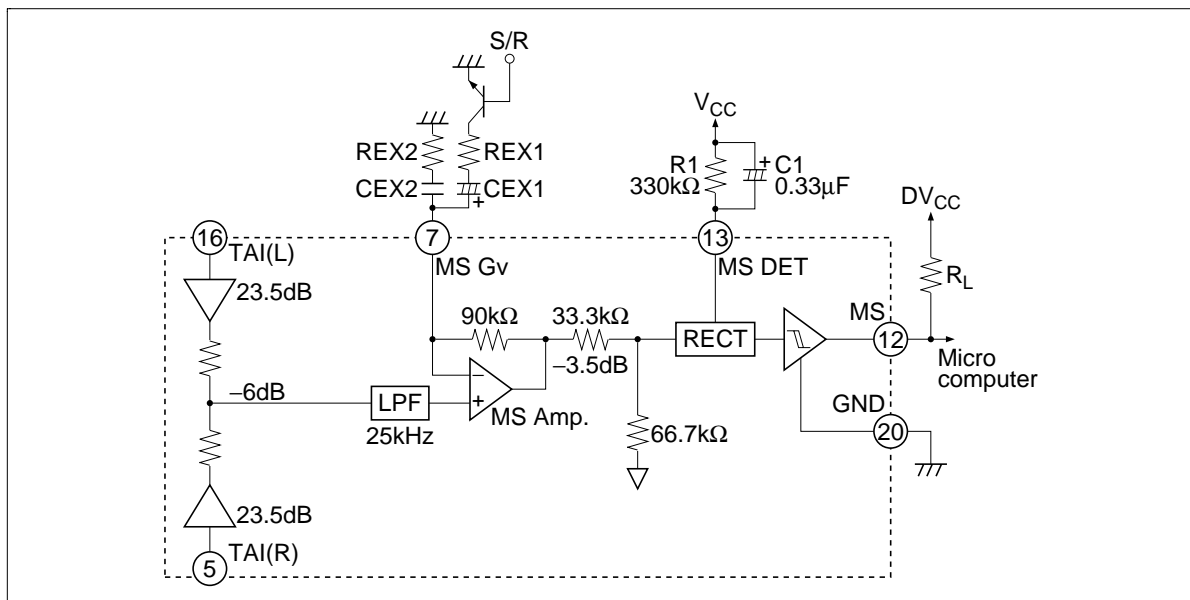

Figure 4 Music Sensor Block Diagram

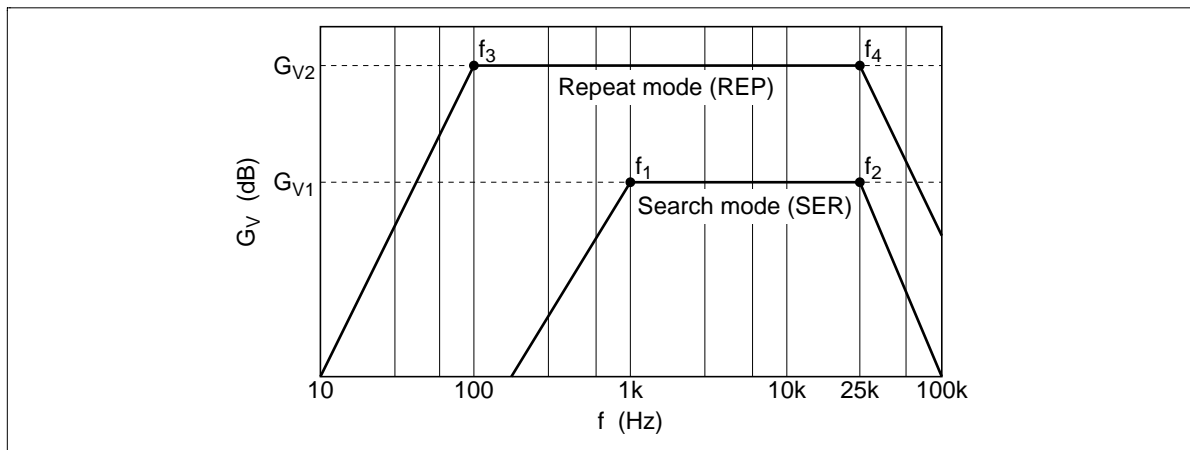

Figure 5 Frequency Response

1. Search mode

$$G_{V1} = (23.5\text{dB} - 3.5\text{dB}) + 20\log\left(1 + \frac{90\text{k}}{\text{REX2}}\right) \text{ [dB]}$$

$$f_1 = \frac{1}{2\pi \cdot \text{CEX2} \cdot \text{REX2}} \text{ [Hz]}, f_2 = 25\text{k} \text{ [Hz]}$$

2. Repeat mode

$$G_{V2} = (23.5\text{dB} - 3.5\text{dB}) + 20\log\left(1 + \frac{90\text{k}}{\text{REX1}}\right) \text{ [dB]}$$

$$f_3 = \frac{1}{2\pi \cdot \text{CEX1} \cdot \text{REX1}} \text{ [Hz]}, f_4 = 25\text{k} \text{ [Hz]}$$

The sensitivity of music sensor (S) is computed by the formula mentioned below.

$$S = 12.7 - G_V \text{ [dB]}$$

S is 6 dB down in case of one-side channel.

Notes: 1. Search mode: G_{V1} , Repeat mode: G_{V2}

2. Standard level of TAI pin (Dolby level correspondence) = 30 mVrms

3. Standard sensing level of music sensor = 130 mVrms

Item	REX1, 2	CEX1, 2	$G_{V1, 2}$	$f_{1, 3}$	$f_{2, 4}$	S (one side channel)	S (both channel)
Search mode	24 kΩ	0.01 μF	33.5 dB	663 Hz	25 kHz	-14.8 dB	-20.8 dB
Repeat mode	2.4 kΩ	1 μF	51.7 dB	66.3 Hz	25 kHz	-33.0 dB	-39.0 dB

Note: This MS presented hysteresis lest MS(OUT) terminal should turn over again High level or Low level, in case of thresh S level constantly.

Music Sensor Time Constant

- Sensing no signal to signal (Attack) is determined by C1, 0.01 μF to 1 μF capacitor C1 can be applicable.
- Sensing signal to no signal (Recovery) is determined by C1 and R1, however preceding (1), 100 kΩ to 1 MΩ can be applicable.

Music Sensor Output (MS(OUT))

As for the internal circuit of music sensor block, music sensor output pin is connected to the collector of NPN type directly, therefore, output level will be “high” when sensing no signal. And output level will be “low” when sensing signal.

$$I_L = \frac{DV_{CC} - \text{MS(OUT)}_{LO}^*}{R_L}$$

* MS(OUT)_{LO} : Sensing signal (about 1V)

Note: Supply voltage of MS(OUT) pin must be less than V_{CC} voltage.

Characteristic Curves

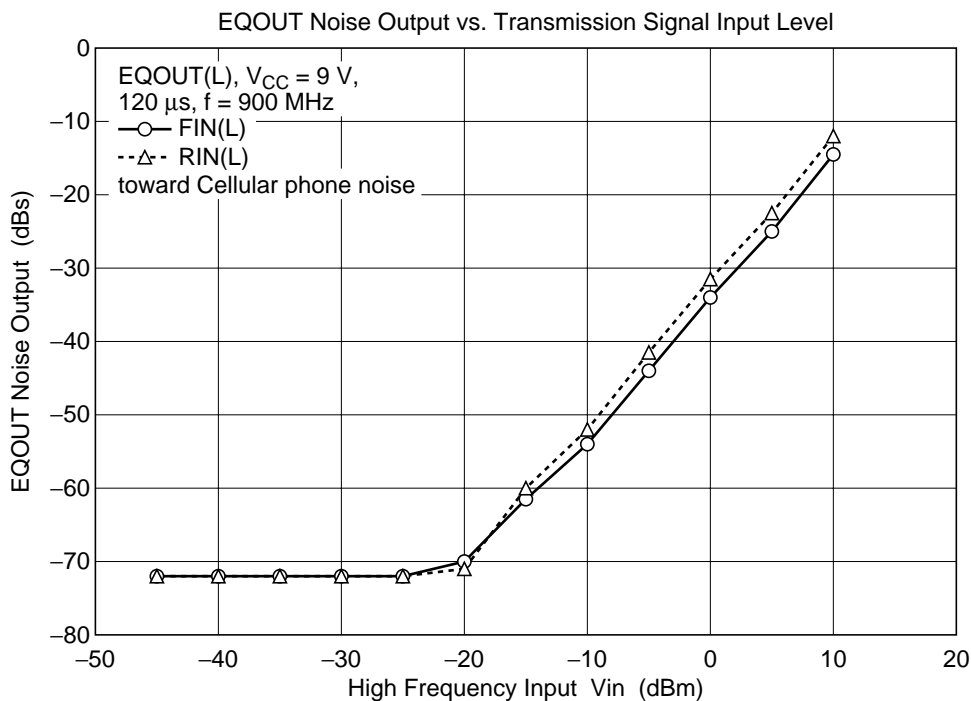
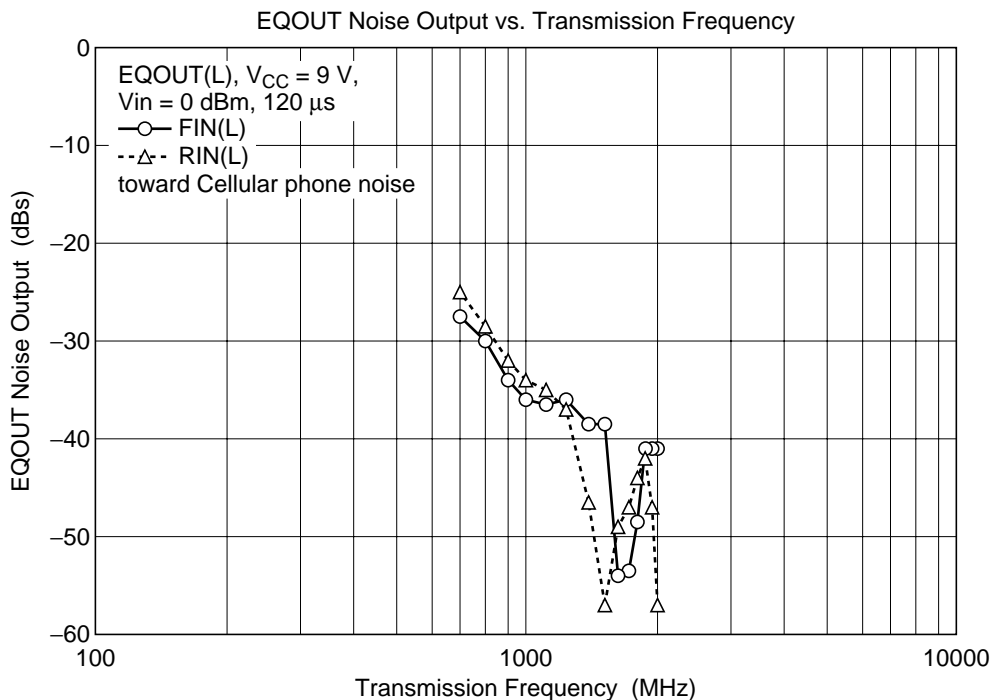

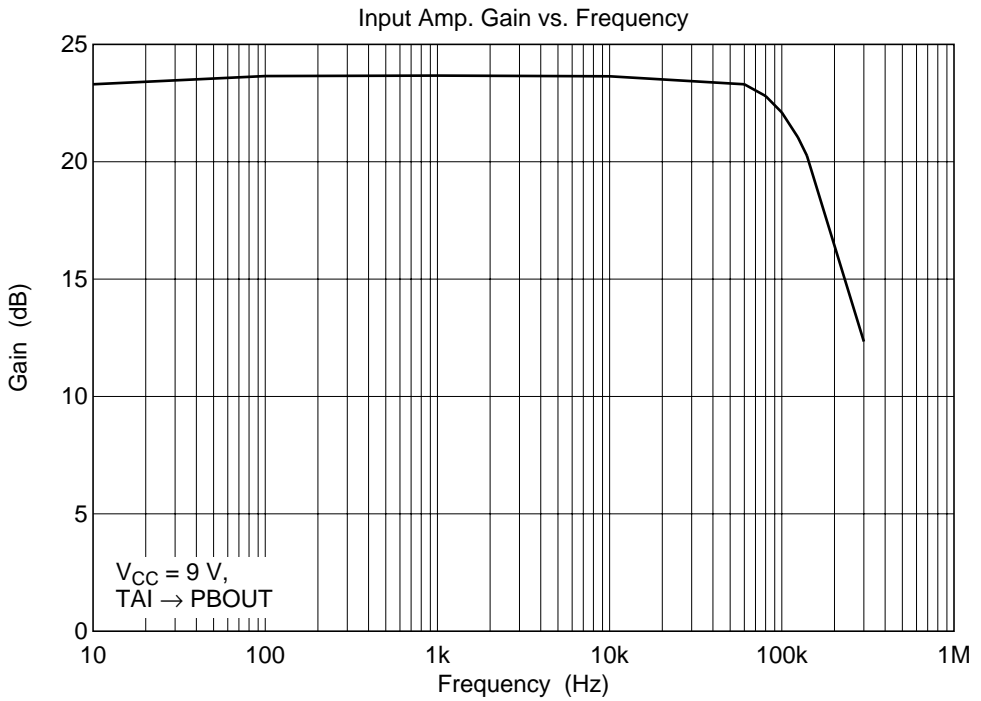
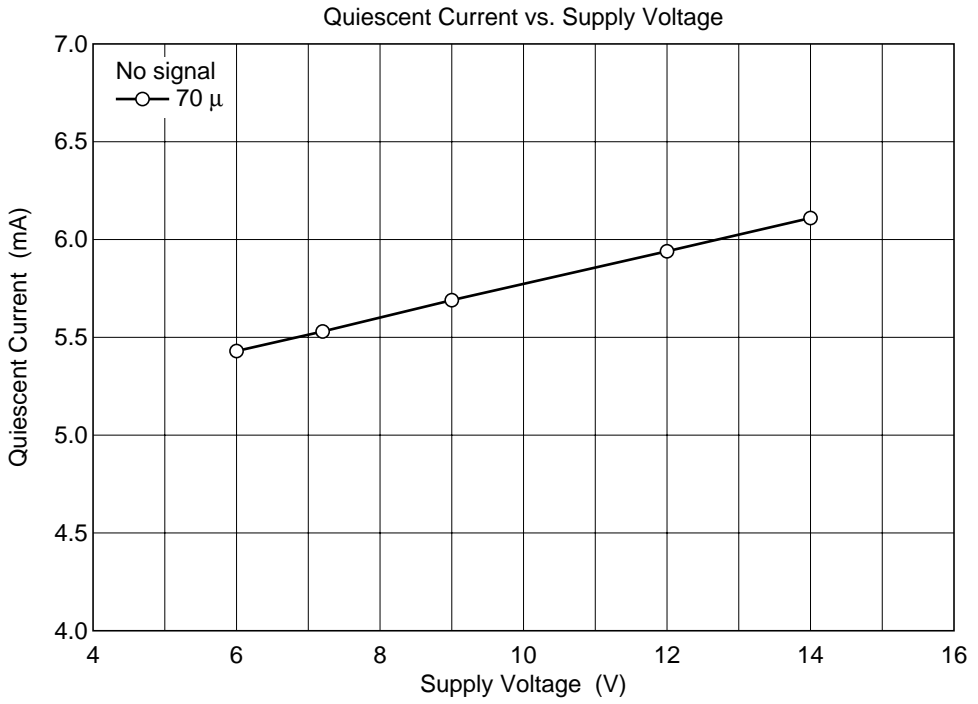

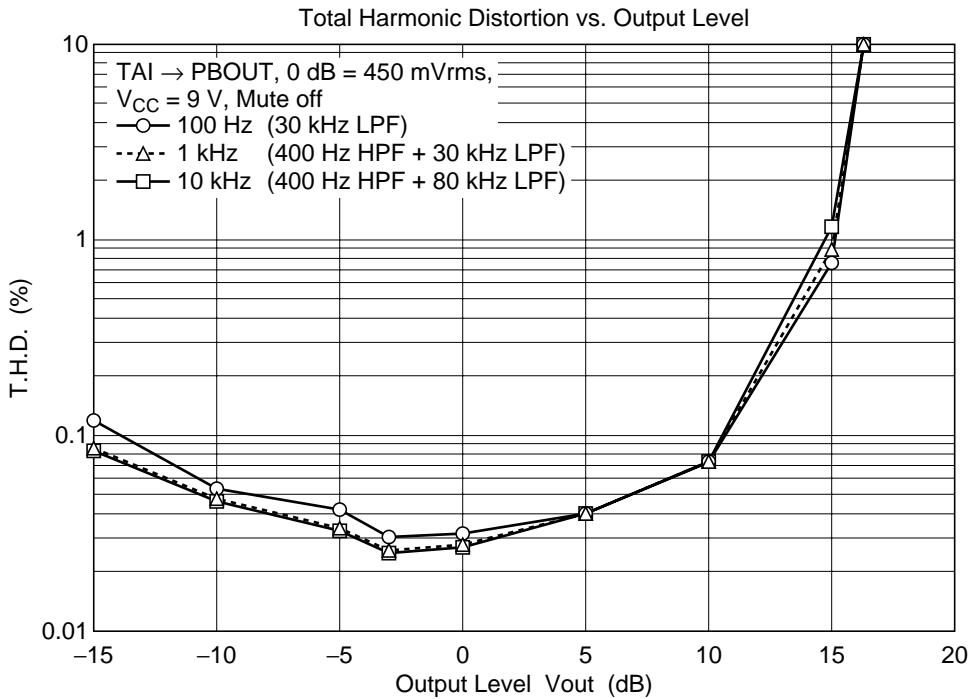
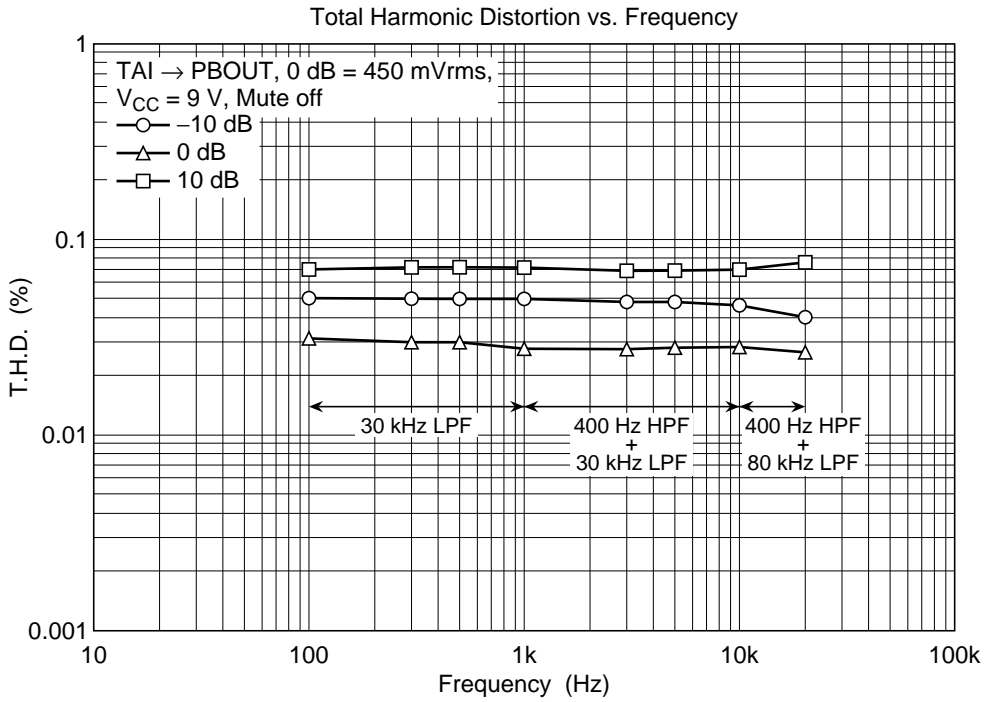

Total Harmonic Distortion vs. Supply Voltage

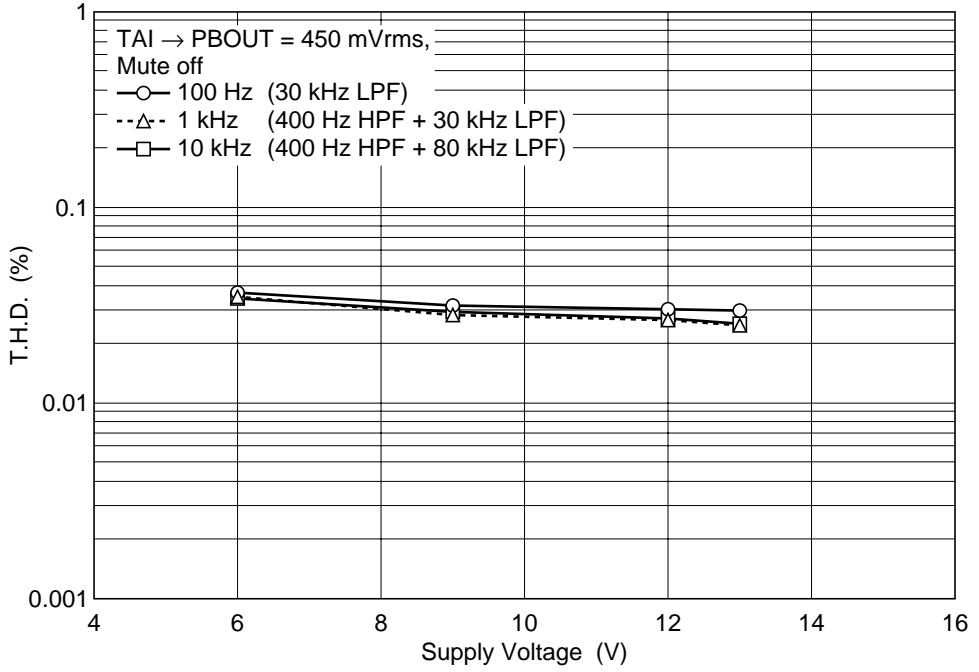

Signal Handling

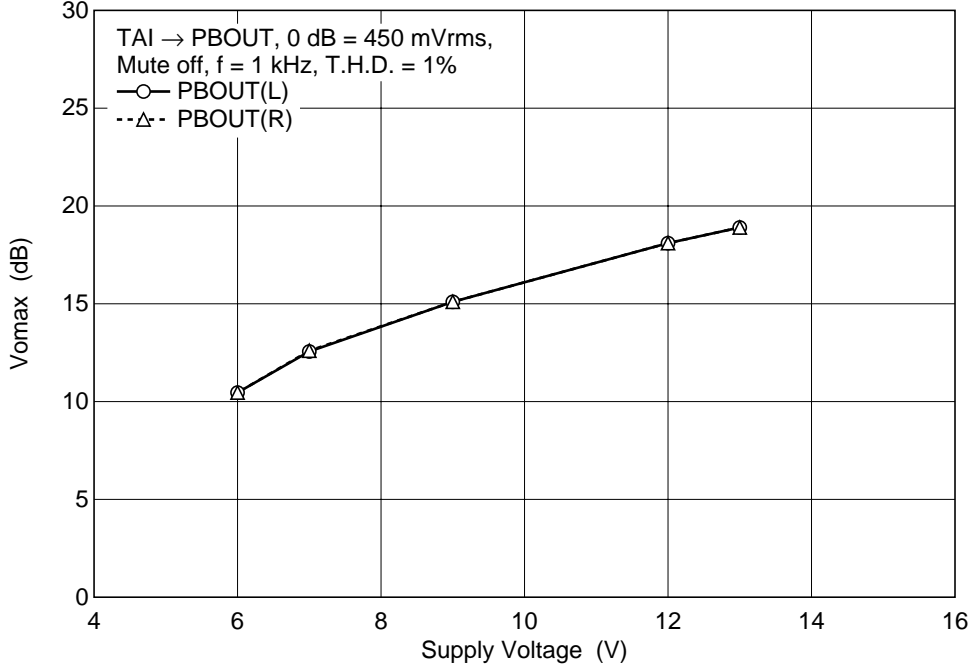

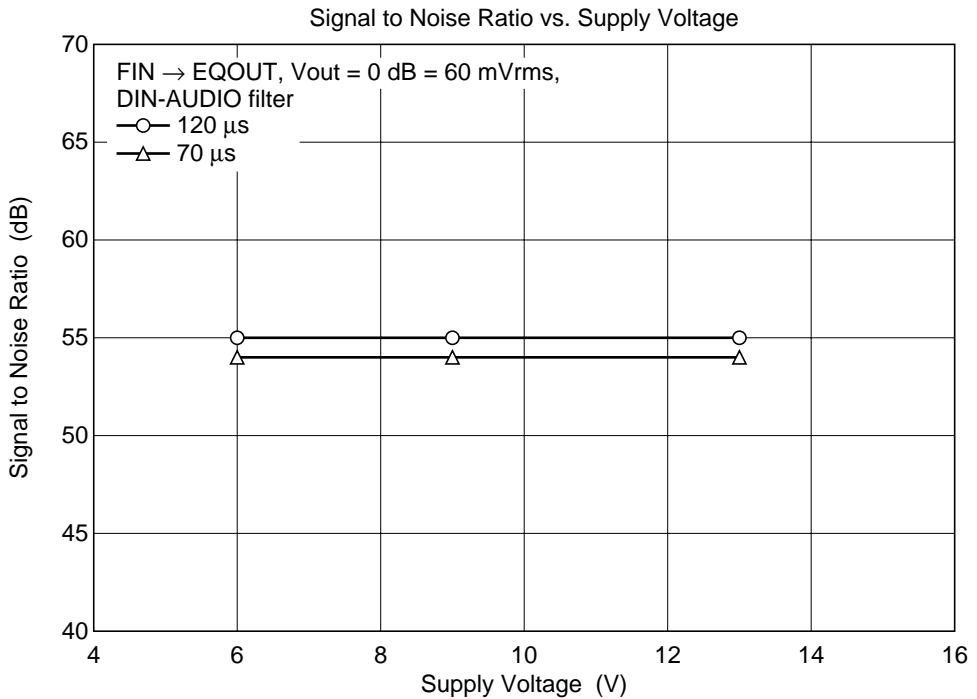
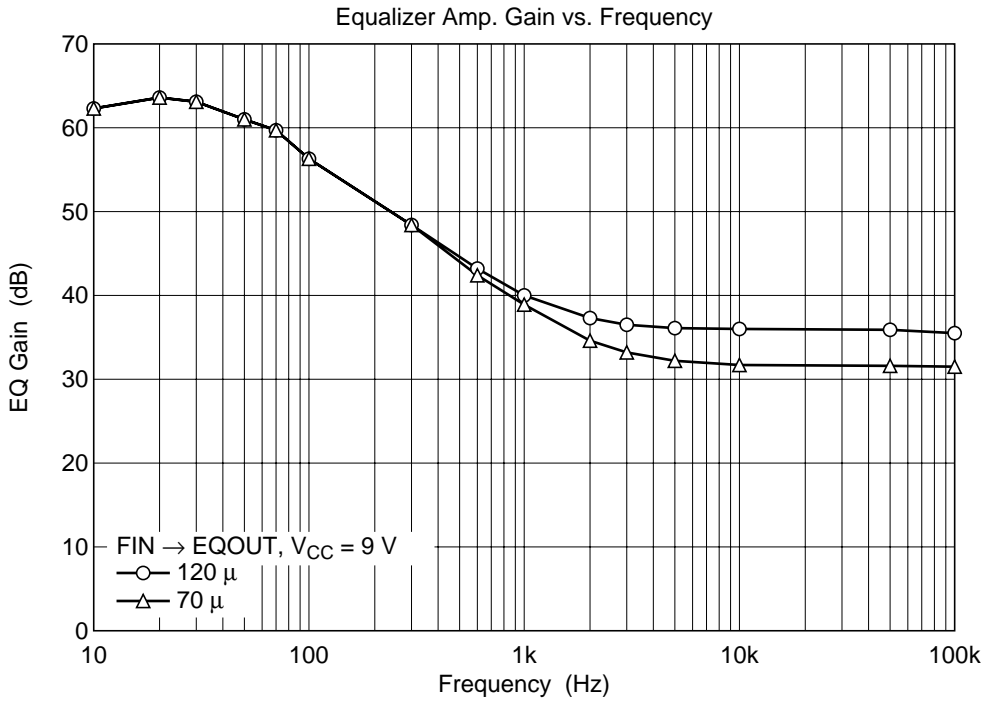

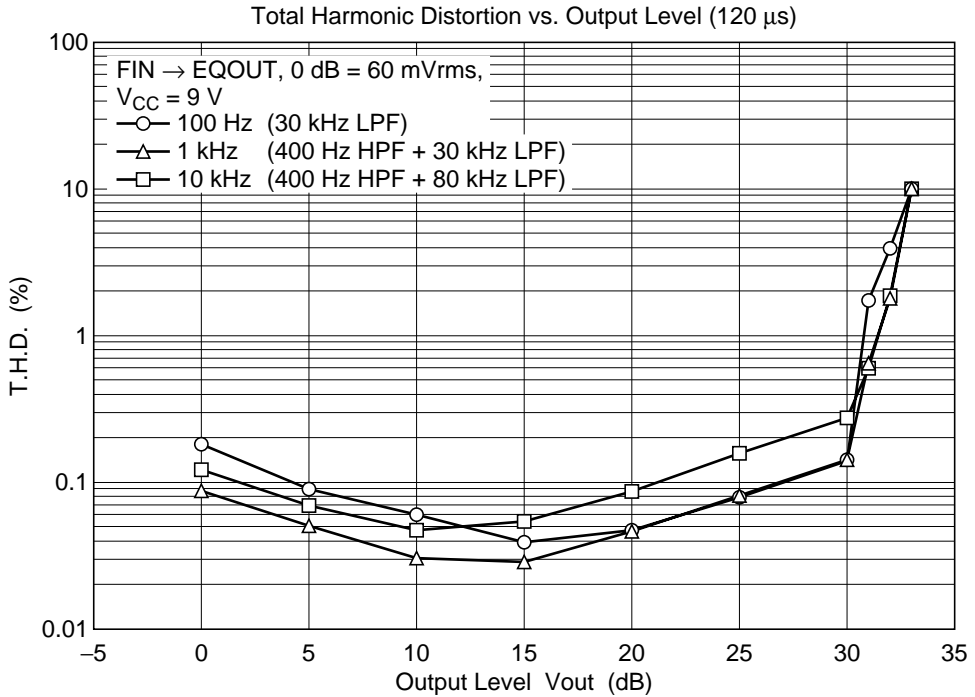
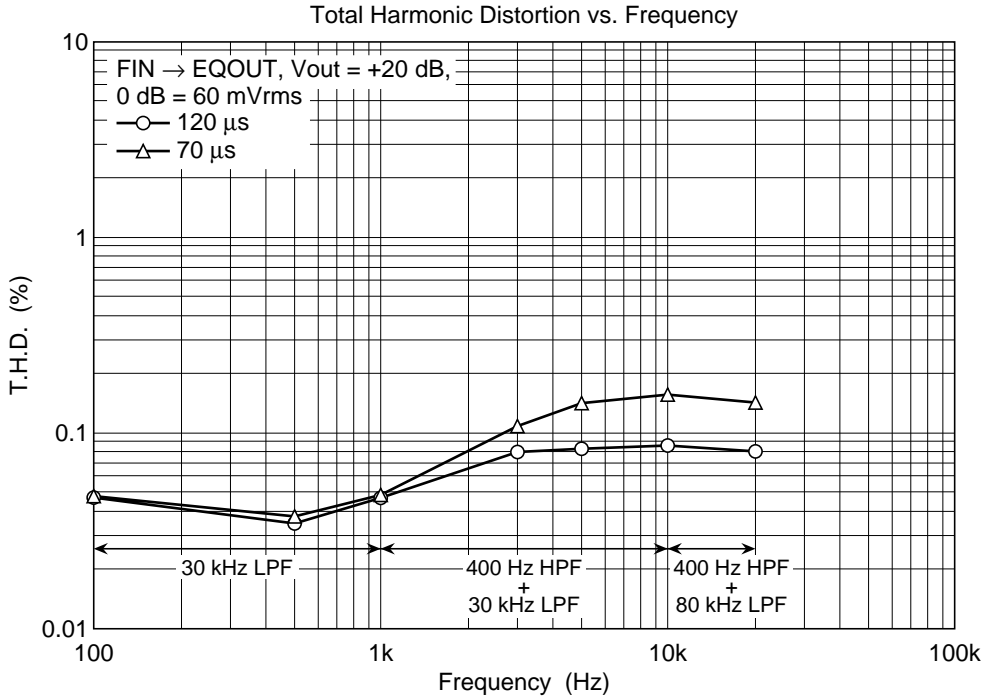

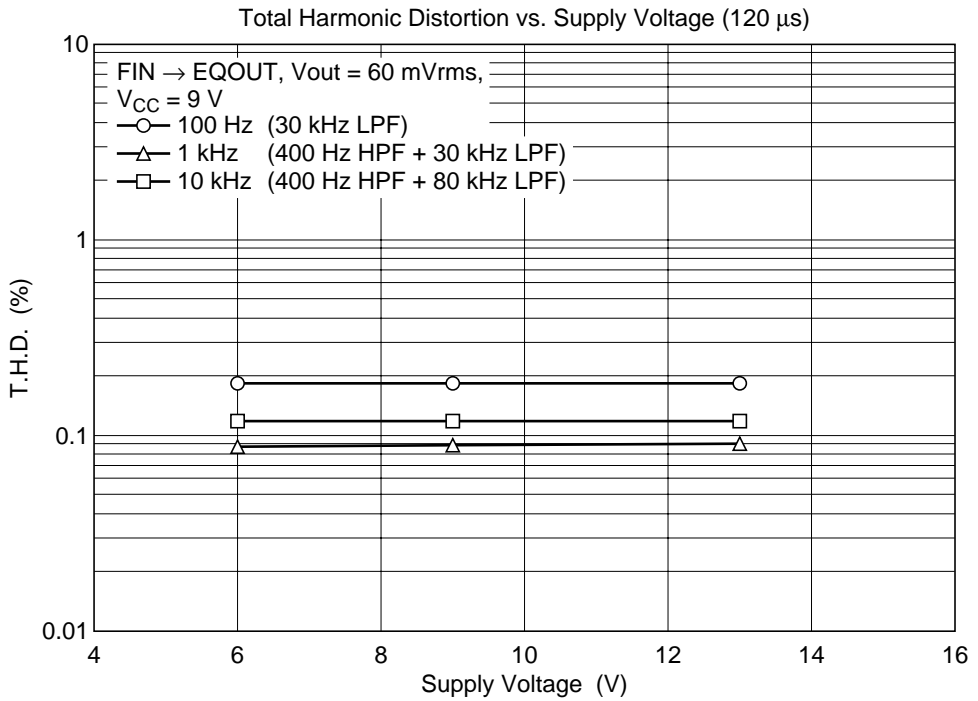
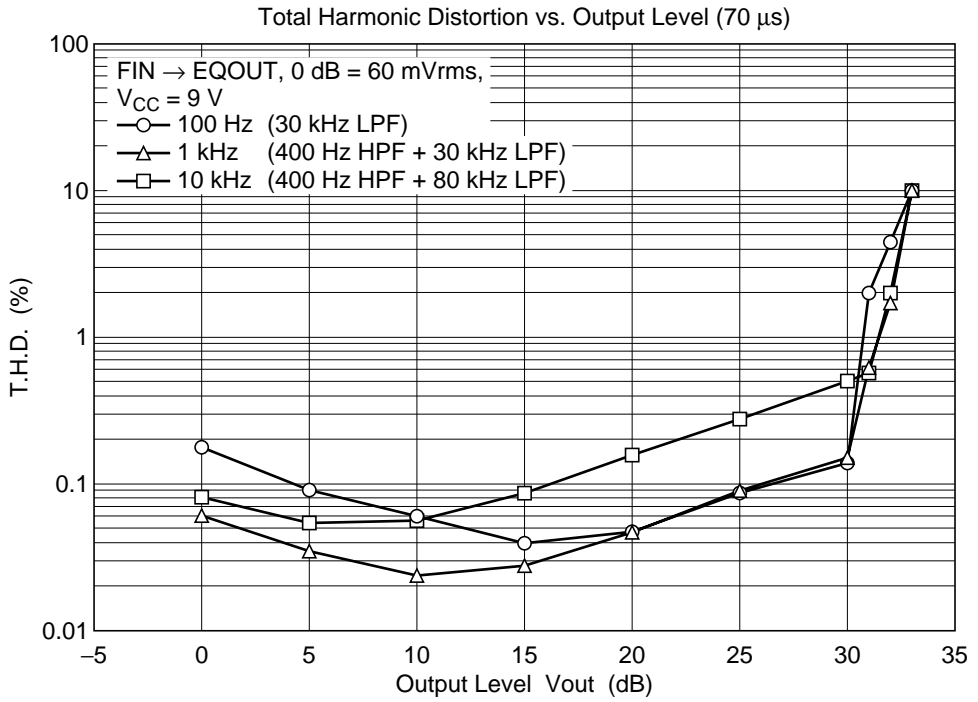

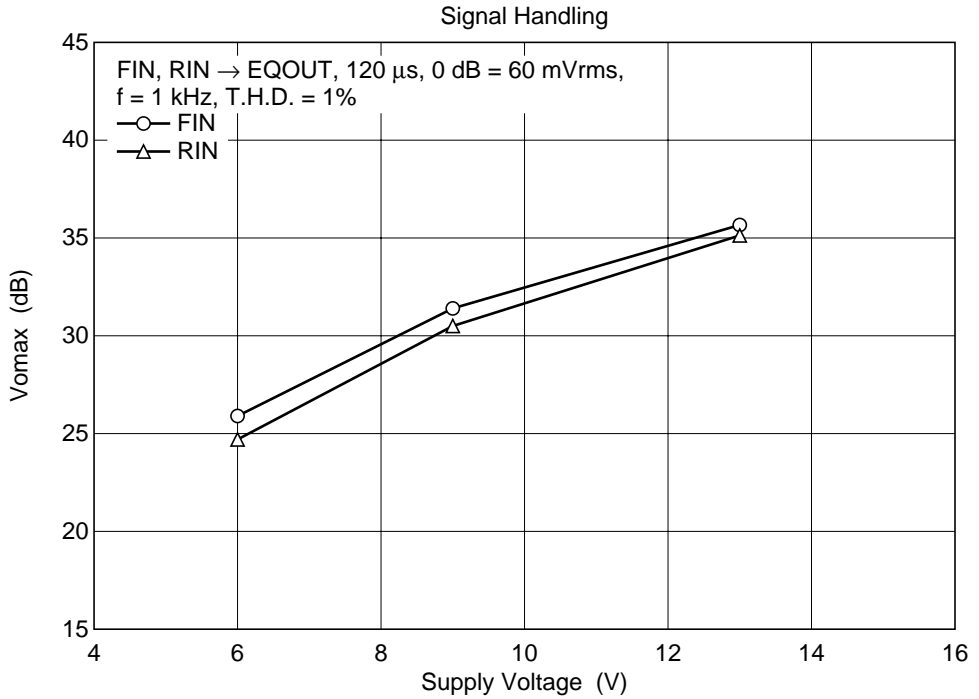
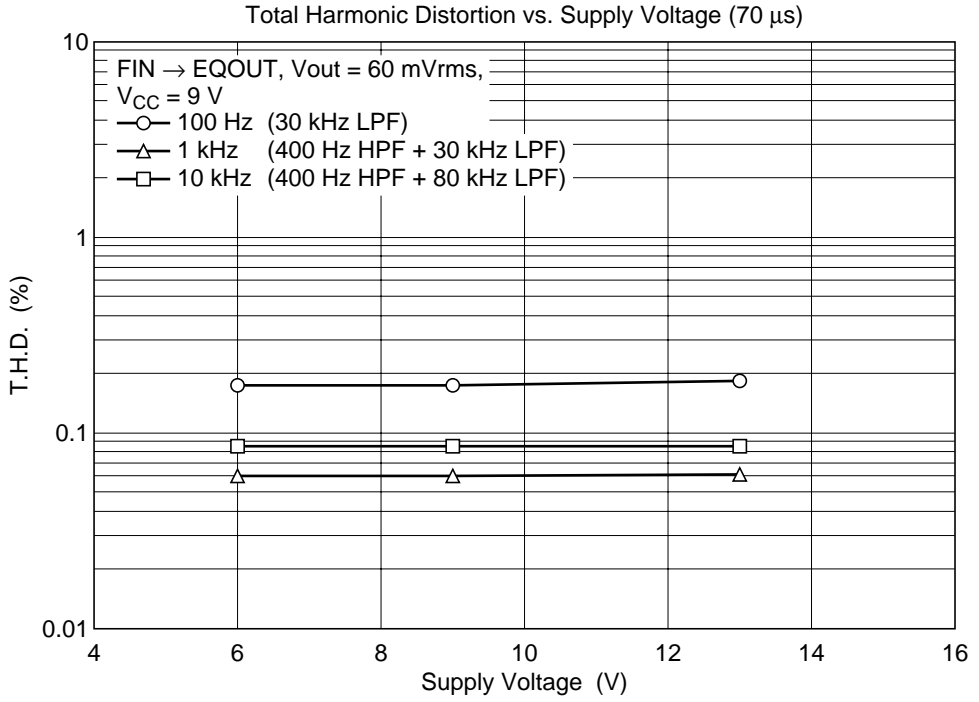

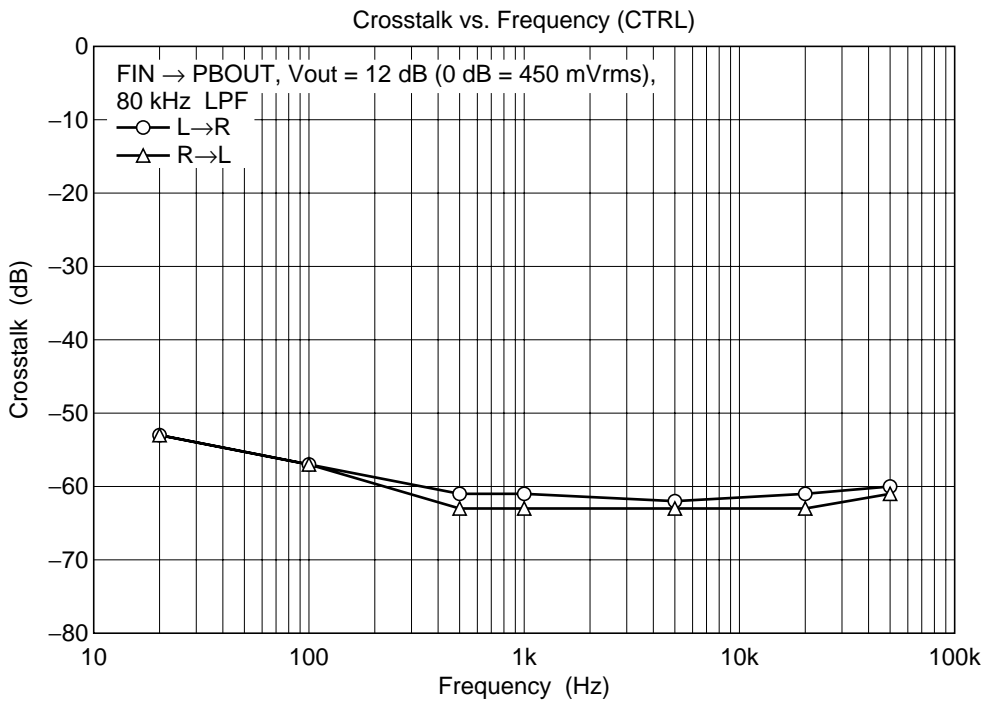
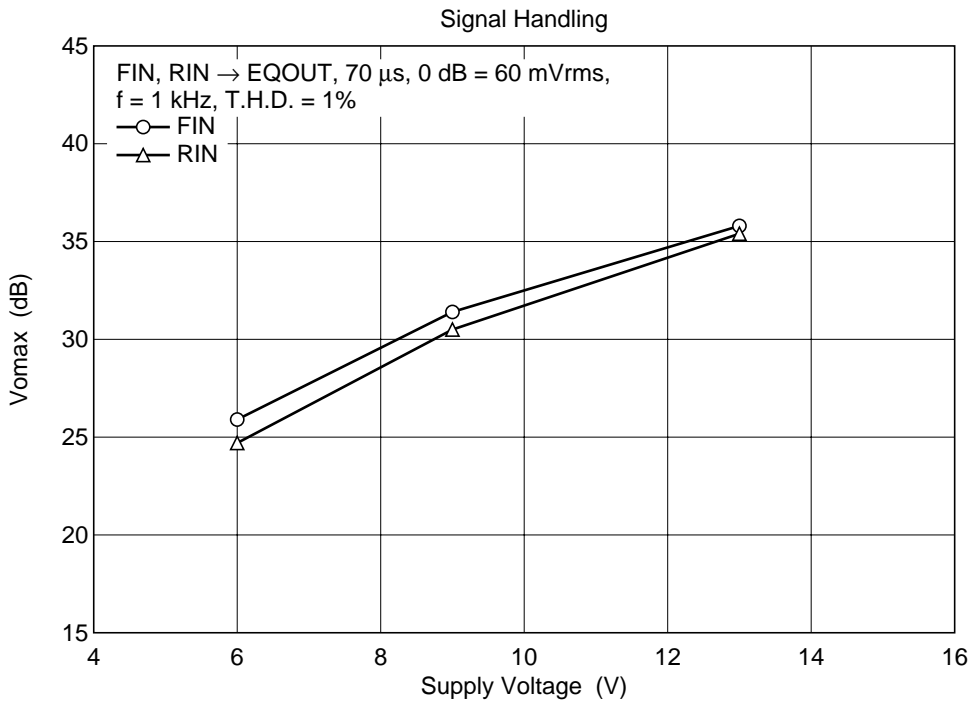

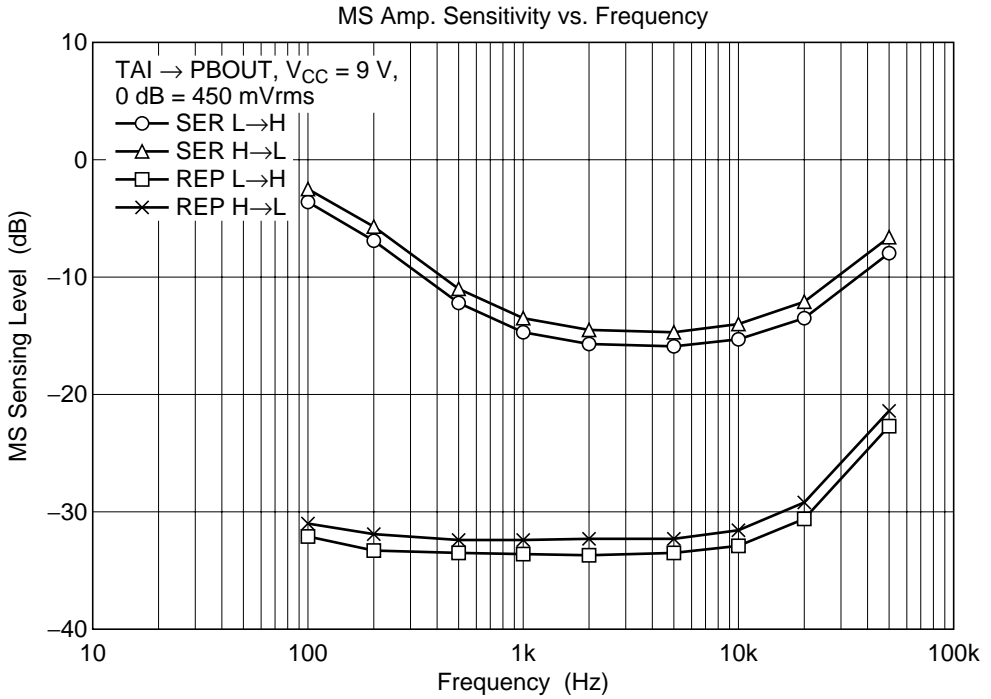
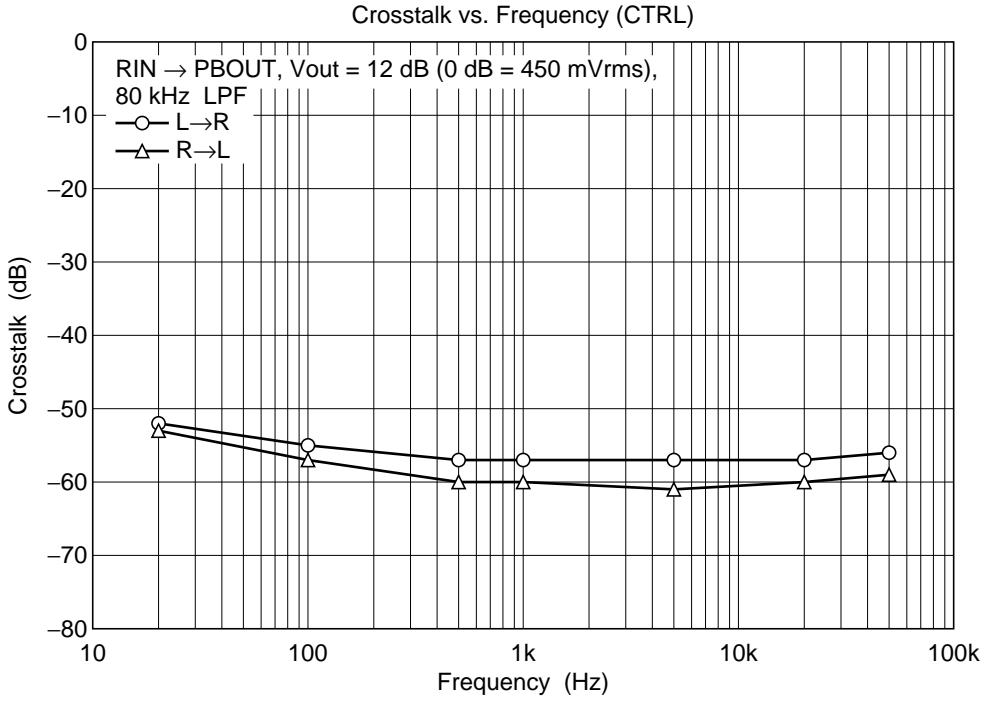

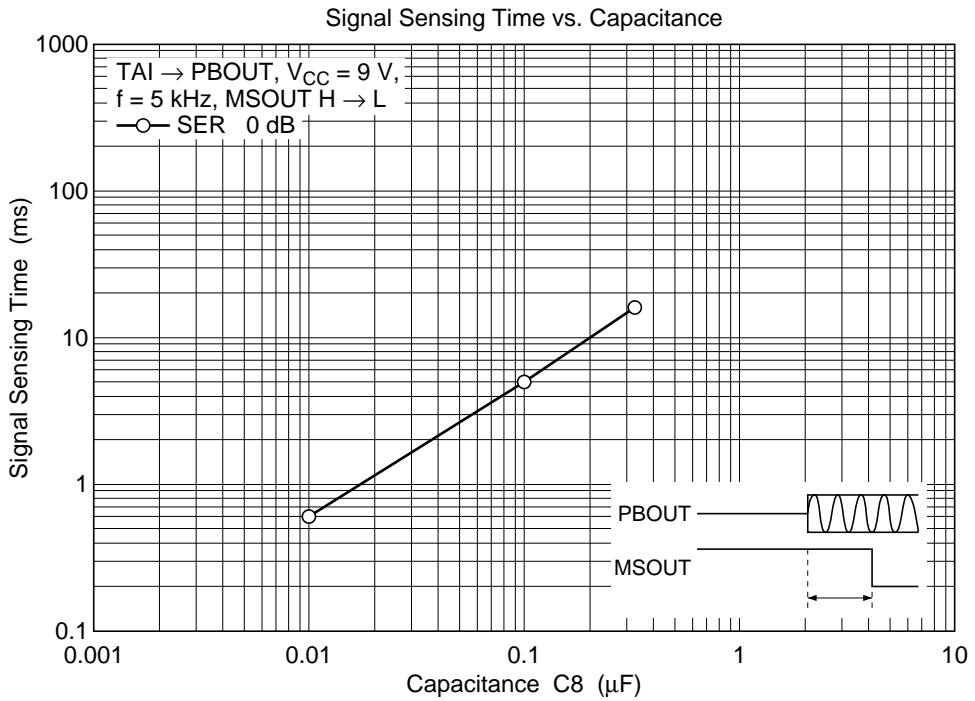
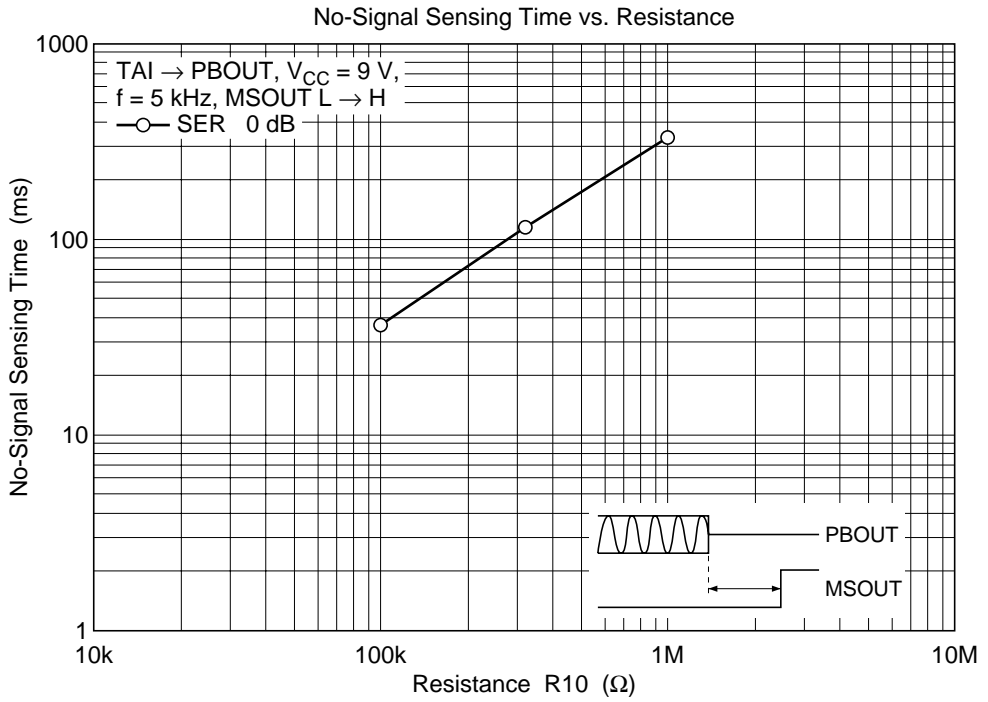

Package Dimensions

Unit: mm

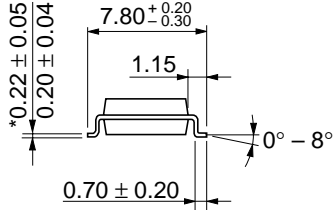
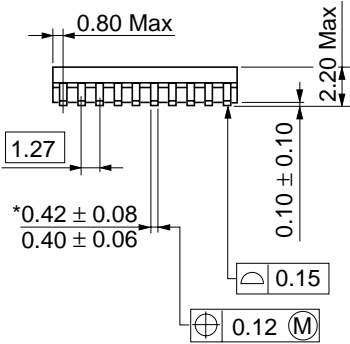
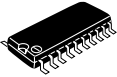
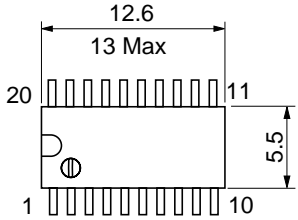

*Dimension including the plating thickness
Base material dimension

Hitachi Code	FP-20DA
JEDEC	—
EIAJ	Conforms
Mass (reference value)	0.31 g

Cautions

1. Hitachi neither warrants nor grants licenses of any rights of Hitachi's or any third party's patent, copyright, trademark, or other intellectual property rights for information contained in this document. Hitachi bears no responsibility for problems that may arise with third party's rights, including intellectual property rights, in connection with use of the information contained in this document.
2. Products and product specifications may be subject to change without notice. Confirm that you have received the latest product standards or specifications before final design, purchase or use.
3. Hitachi makes every attempt to ensure that its products are of high quality and reliability. However, contact Hitachi's sales office before using the product in an application that demands especially high quality and reliability or where its failure or malfunction may directly threaten human life or cause risk of bodily injury, such as aerospace, aeronautics, nuclear power, combustion control, transportation, traffic, safety equipment or medical equipment for life support.
4. Design your application so that the product is used within the ranges guaranteed by Hitachi particularly for maximum rating, operating supply voltage range, heat radiation characteristics, installation conditions and other characteristics. Hitachi bears no responsibility for failure or damage when used beyond the guaranteed ranges. Even within the guaranteed ranges, consider normally foreseeable failure rates or failure modes in semiconductor devices and employ systemic measures such as fail-safes, so that the equipment incorporating Hitachi product does not cause bodily injury, fire or other consequential damage due to operation of the Hitachi product.
5. This product is not designed to be radiation resistant.
6. No one is permitted to reproduce or duplicate, in any form, the whole or part of this document without written approval from Hitachi.
7. Contact Hitachi's sales office for any questions regarding this document or Hitachi semiconductor products.

HITACHI

Hitachi, Ltd.

Semiconductor & Integrated Circuits.

Nippon Bldg., 2-6-2, Ohte-machi, Chiyoda-ku, Tokyo 100-0004, Japan

Tel: Tokyo (03) 3270-2111 Fax: (03) 3270-5109

URL	NorthAmerica	: http://semiconductor.hitachi.com/
	Europe	: http://www.hitachi-eu.com/hel/ecg
	Asia	: http://sicapac.hitachi-asia.com
	Japan	: http://www.hitachi.co.jp/Sicd/indx.htm

For further information write to:

Hitachi Semiconductor
(America) Inc.
179 East Tasman Drive,
San Jose, CA 95134
Tel: <1> (408) 433-1990
Fax: <1> (408) 433-0223

Hitachi Europe GmbH
Electronic Components Group
Dornacher StraÙe 3
D-85622 Feldkirchen, Munich
Germany
Tel: <49> (89) 9 9180-0
Fax: <49> (89) 9 29 30 00

Hitachi Europe Ltd.
Electronic Components Group.
Whitebrook Park
Lower Cookham Road
Maidenhead
Berkshire SL6 8YA, United Kingdom
Tel: <44> (1628) 585000
Fax: <44> (1628) 585160

Hitachi Asia Ltd.
Hitachi Tower
16 Collyer Quay #20-00,
Singapore 049318
Tel: <65>-538-6533/538-8577
Fax : <65>-538-6933/538-3877
URL : <http://www.hitachi.com.sg>

Hitachi Asia Ltd.
(Taipei Branch Office)
4/F, No. 167, Tun Hwa North Road,
Hung-Kuo Building,
Taipei (105), Taiwan
Tel: <886>-(2)-2718-3666
Fax : <886>-(2)-2718-8180
Telex : 23222 HAS-TP
URL : <http://www.hitachi.com.tw>

Hitachi Asia (Hong Kong) Ltd.
Group III (Electronic Components)
7/F., North Tower,
World Finance Centre,
Harbour City, Canton Road
Tsim Sha Tsui, Kowloon,
Hong Kong
Tel : <852>-(2)-735-9218
Fax : <852>-(2)-730-0281
URL : <http://www.hitachi.com.hk>

Copyright © Hitachi, Ltd., 2001. All rights reserved. Printed in Japan.
Colophon 2.0

HITACHI