

HA1374

Dual 2 to 3W Audio Power Amplifiers

The HA1374 is a monolithic dual power amplifier designed especially for economical type stereo phonographs encapsulated in a 10-lead single-in-line plastic package.

The HA1374 provides an output power of 3 watts per channel with 8 ohm load at 10 percent distortion at 15 volt power supply.

FEATURES

- Dual power amplifier: 2 to 3 watts per channel.
- Less number of external components:
(Capacitor: 9, Resistor: 2 per 2 channel)
- Wide Supply Voltage Range: from 8 to 22V.
- Internal thermal protection.
- Internal phase compensation included.
- High cross-talk: typ. 56 dB

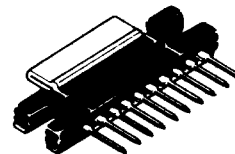

(SP-10TA)

Handwritten note: 14V #210

TYPICAL APPLICATION

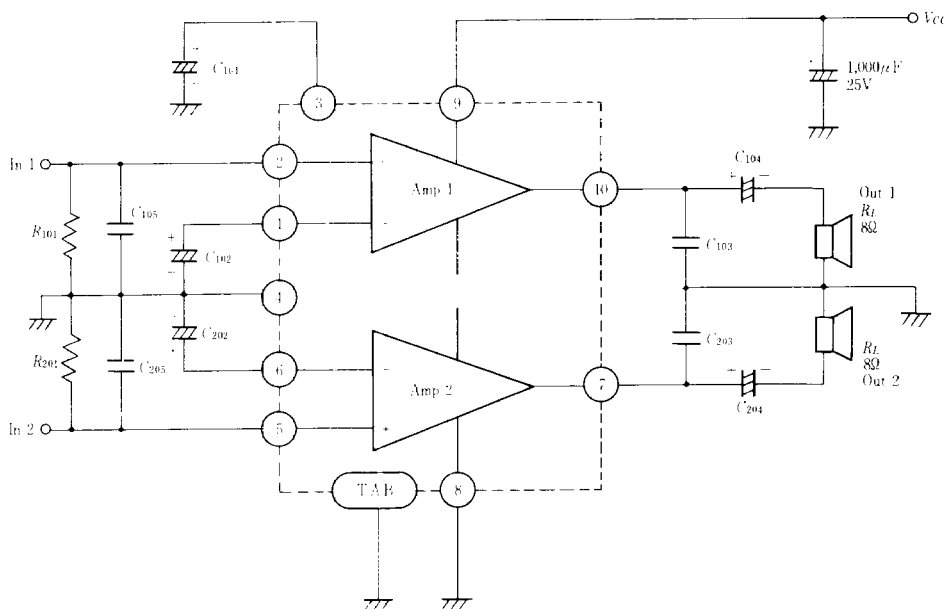

External Parts	Recommended Value
C ₁₀₁	100μF (10V)
C ₁₀₂ , C ₂₀₂	100μF (6.3V)
C ₁₀₃ , C ₂₀₃	0.1μF
C ₁₀₄ , C ₂₀₄	470μF (10V)
C ₁₀₅ , C ₂₀₅	220pF
R ₁₀₁ , R ₂₀₁	100kΩ

ABSOLUTE MAXIMUM RATINGS (Ta = 25°C)

Item	Symbol	Rating	Unit
Supply Voltage	V _{CC}	22	V
Output Current per Channel	I _O	2.8	A
Power Dissipation*	P _T	7.2	W
Thermal Resistance (Junction-Case)	θ _{J-C}	10	°C/W
Junction Temperature	T _J	150	°C
Operating Temperature	T _{opr}	-20 to +70	°C
Storage Temperature	T _{stg}	-55 to +125	°C

* Value at T = 78°C

■ **ELECTRICAL CHARACTERISTICS** ($T_a=25^{\circ}\text{C}$, $V_{CC}=15\text{V}$, $R_L=8\Omega$, One-half Operation of Dual Amplifier)

Item	Symbol	Test Condition	min.	typ.	max.	Unit
Quiescent Current	I_Q	$V_{in}=0$ (Dual total)	18	36	70	mA
Voltage Gain	G_V	$f=1\text{kHz}$	—	46	—	dB
Difference of Voltage Gain	ΔG_V	$f=1\text{kHz}$	—	—	1.5	dB
Output Power per Channel	P_o	$R_L=8\Omega$, $THD=10\%$	2.0	3.0	—	W
Total Harmonic Distortion	THD	$P_o=0.5\text{W}$	—	0.1	1.0	%
Noise Output	WBN	$R_s=10\text{k}\Omega$, $BW=20\text{Hz}$ to 20kHz	—	0.5	1.5	mV
Input Resistance	R_{in}	$f=1\text{kHz}$	—	100	—	$\text{k}\Omega$
Cross-Talk	$C.T$	$f=1\text{kHz}$, $R_s=10\text{k}\Omega$	40	56	—	dB
Supply Voltage Rejection Ratio	SVR	$f=100\text{Hz}$, $R_s=600\Omega$	—	40	—	dB
Roll-off Frequency	f_L	$G_V=-3\text{dB}$ from	Low	—	45	Hz
	f_H	$f=1\text{kHz}$ Ref.	High	—	30k	

■ **PC-BOARD LAYOUT PATTERN**

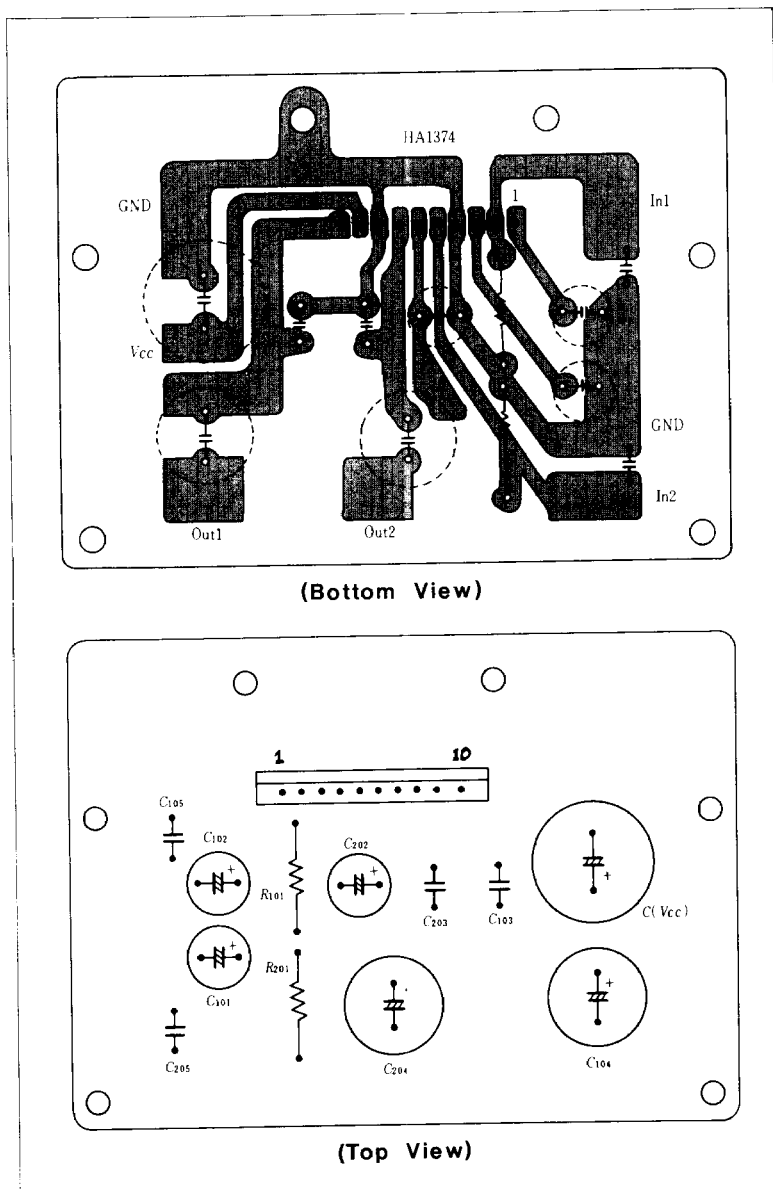

■ **HEAT SINK**

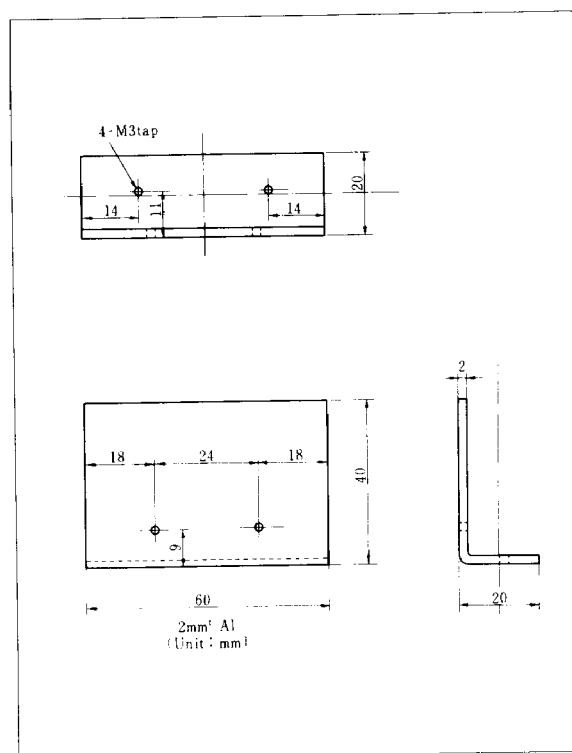

OUTPUT POWER vs. SUPPLY VOLTAGE

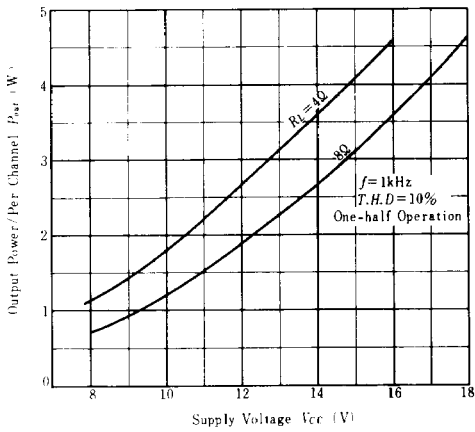

TOTAL HARMONIC DISTORTION vs. OUTPUT POWER

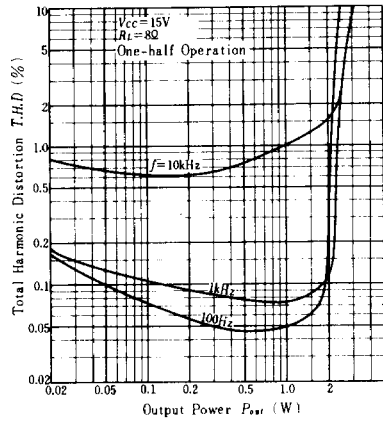

TOTAL HARMONIC DISTORTION vs. FREQUENCY

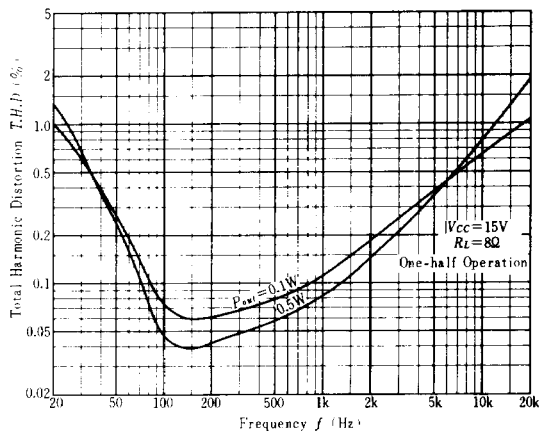

OUTPUT POWER vs. FREQUENCY

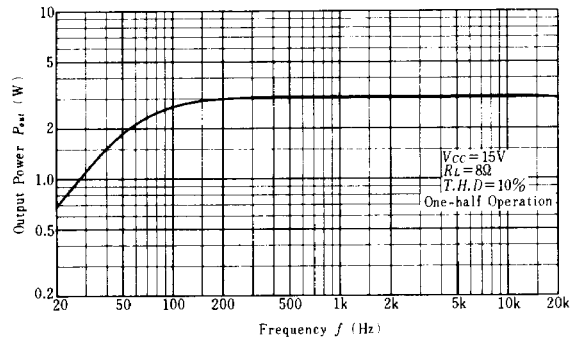

VOLTAGE GAIN vs. FREQUENCY

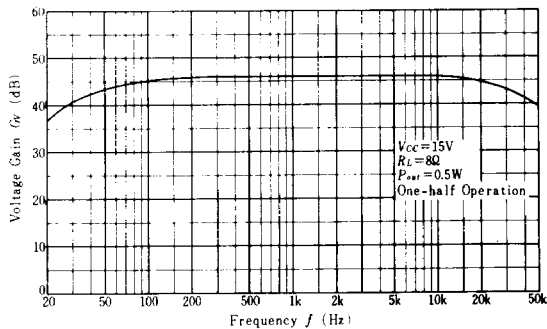

WIDE BAND NOISE vs. SIGNAL SOURCE RESISTANCE

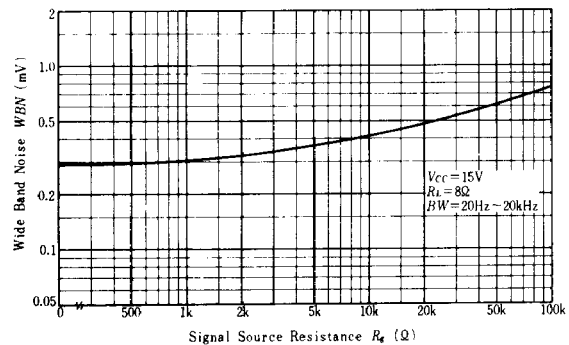

HA1374

CROSS-TALK vs. FREQUENCY

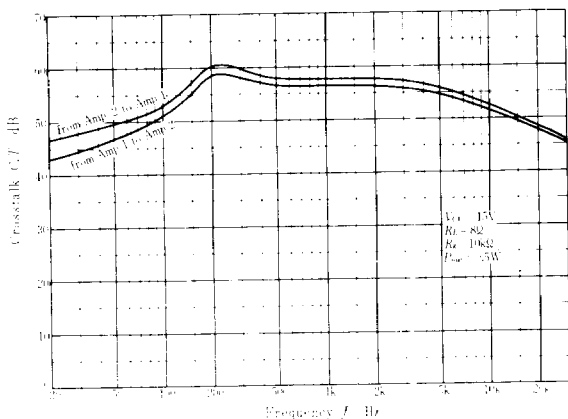

QUIESCENT CURRENT vs. SUPPLY VOLTAGE

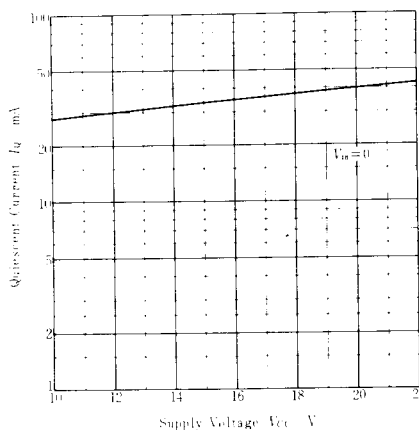

SUPPLY VOLTAGE REJECTION RATIO vs. FREQUENCY

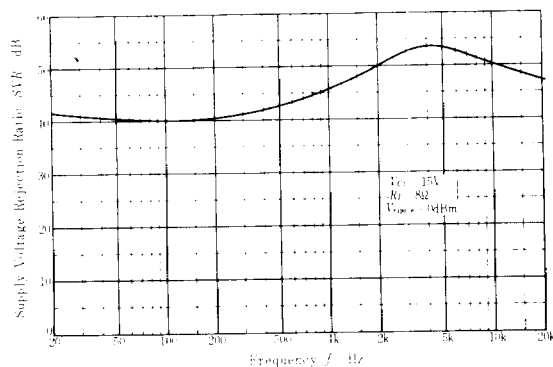

POWER DISSIPATION vs. OUTPUT POWER

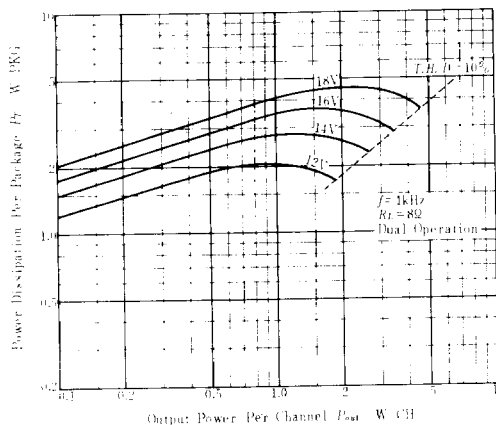

METHOD OF CHANGING THE VOLTAGE GAIN

The HA1374's voltage gain, as shown in Fig. 1, depends on the internal feedback resistors.

$$\text{The voltage gain, } G_v = \frac{R_1 + R_2}{R_2}$$

The HA1374 is designed to get $R_1 = 16k\Omega$ typ. and $R_2 = 80\Omega$ typ., therefore, in the case of typical external applications,

$$G_v = \frac{16000 + 80}{80} \approx 200 \text{ Times} = 46\text{dB}$$

Since the HA1374 has no inverted input terminal, which makes it possible to change G_v externally, the method of changing G_v is restricted. Two methods shown in Fig. 2, (A) (B) can be used to change G_v .

(A): The external resistor is connected in series with the internal resistor, $R_2 = 80\Omega$

$$G_v = \frac{R_1 + R_2 + R_3}{R_2 + R_3} = \frac{16080 + R_3 (\Omega)}{80 + R_3 (\Omega)}$$

where R_3 = the external resistor

(B): The external feedback resistor is connected in parallel with the internal feedback resistor. Fixing the value of the external feedback resistor at a sufficiently low compared with the internal resistor.

$$G_v \approx \frac{1}{\frac{R_2}{R_1 + R_2} + \frac{R_3}{R_3 + R_4}} \approx \frac{1}{\frac{1}{200} + \frac{R_3}{R_3 + R_4}}$$

where R_3 and R_4 = the external feedback resistors.

By either method, G_v can be determined.

Note : G_V must not be decreased under 40dB; G_V less than 40dB may cause oscillating, because the phase compensation is done internally and cannot be changed externally.

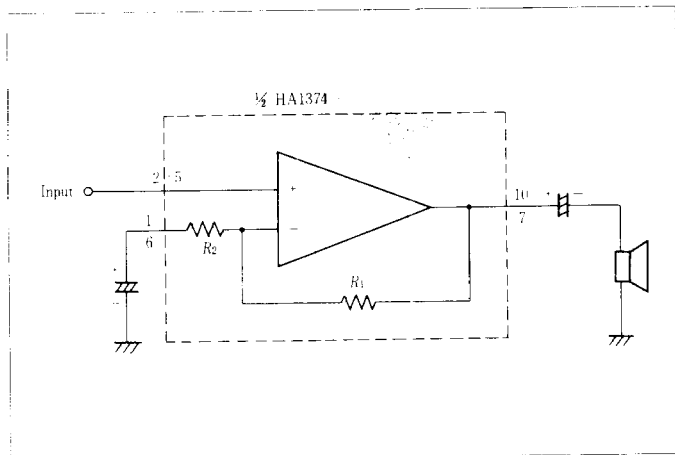

Fig. 1

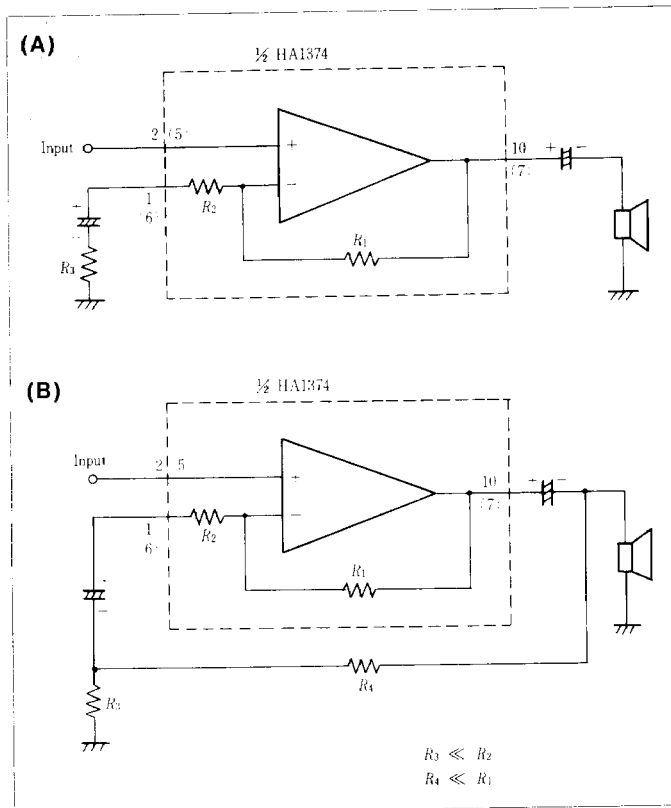
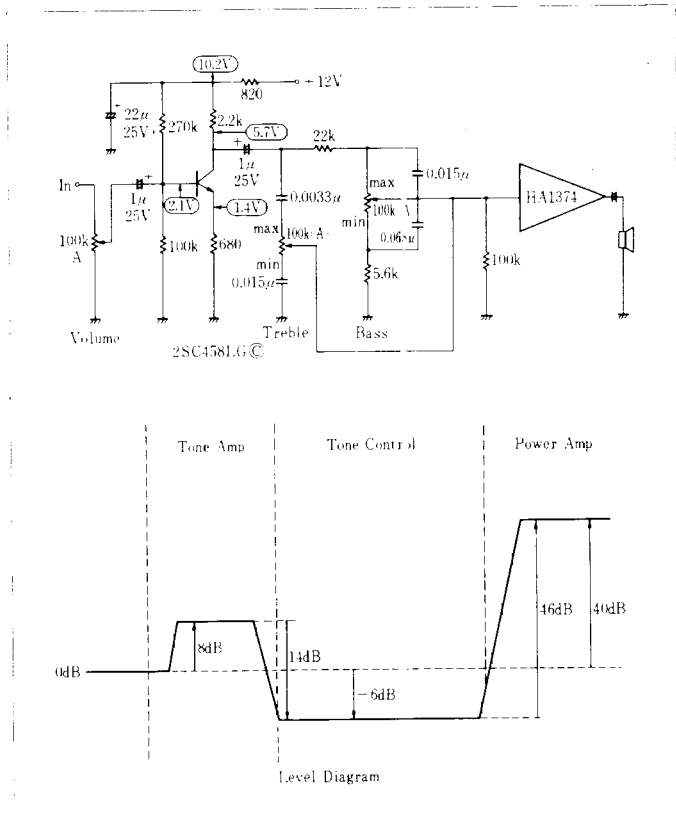

Fig. 2

CIRCUIT EXAMPLES

● Tone Control Circuit for HA1374



VOLTAGE GAIN vs. FREQUENCY

