HA22033

GaAs MMIC Low Noise Amplifier for Micro Wave Application

HITACHI

ADE-207-266 (Z)
1st. Edition
October 1998

Features

- Suitable for low noise amplifier of Micro Wave Application(1.5 to 1.9GHz)
- Low voltage and low current operation (2.7V, 1.7mA typ.)
- Low noise (1.4 dB typ. @1.5GHz)
- High power gain (14 dB typ. @1.5GHz)
- Built-in matching circuits (50Ω)
- Small surface mount package (MPAK-5)

Outline

MPAK-5

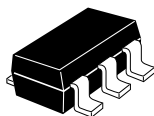

This document may, wholly or partially, be subject to change without notice.

This Device is sensitive to Electro Static Discharge.
An Adequate handling procedure is requested.

CAUTION

This product uses GaAs. Since dust or fume of GaAs is highly poisonous to human body, please do not treat them mechanically in the manner which might expose to the Air. And it should never be thrown

HA22033

Absolute Maximum Ratings (Ta = 25°C)

Item	Symbol	Ratings	Unit
Supply voltage	Vdd	5	V
Maximum current	Idd	6	mA
Power dissipation	Pd	100	mW
Channel temperature	Tch	150	°C
Storage temperature	Tstg	-55 to +125	°C
Operation temperature	Topr	-20 to +70	°C
Maximum input power	Pin max	+15	dBm

Electrical Characteristics (Ta = 25°C, Vdd = 2.7V)

Item	Symbol	Min	Typ	Max	Unit	Test Conditions	Pin
Quiescent current	Idd	—	1.7	2.5	mA	No signal	
Power gain	PG	12	14	—	dB	f = 1.5 GHz	
Noise figure	NF	—	1.4	2	dB	f = 1.5 GHz	

Typical Performance (Ta = 25°C, Vdd = 2.7V)

Item	Symbol	Typ	Unit	Test Conditions	Pin
VSWR (input)	VSWR in	1.5	—	f = 1.5 GHz	4
VSWR (output)	VSWR out	2.2	—	f = 1.5 GHz	1
3rd order intermodulation distortion	IM3	50	dB	f = 1.5 GHz, Pin = -30 dBm	

Block Diagram

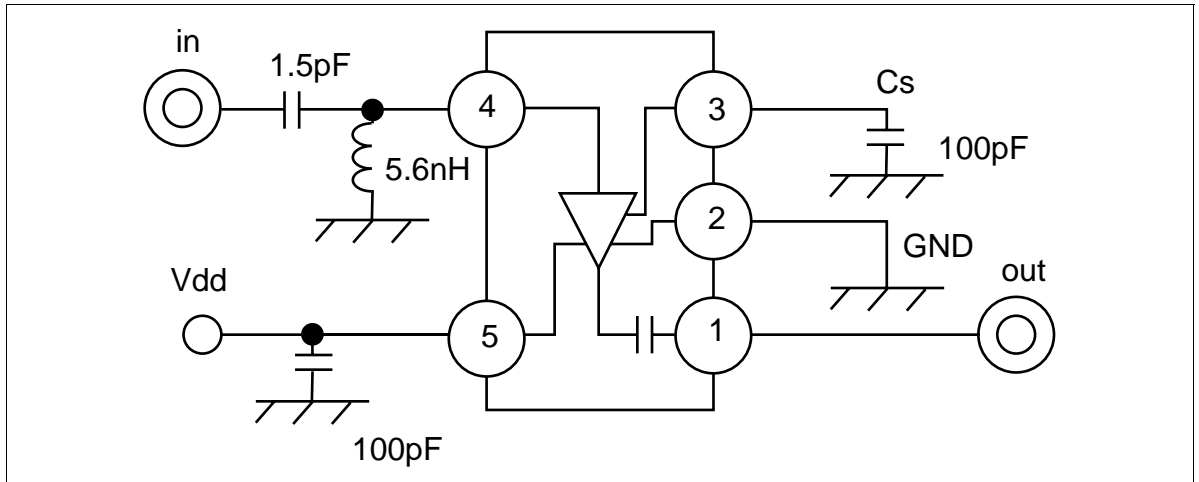

HA22033

Pin Arrangement

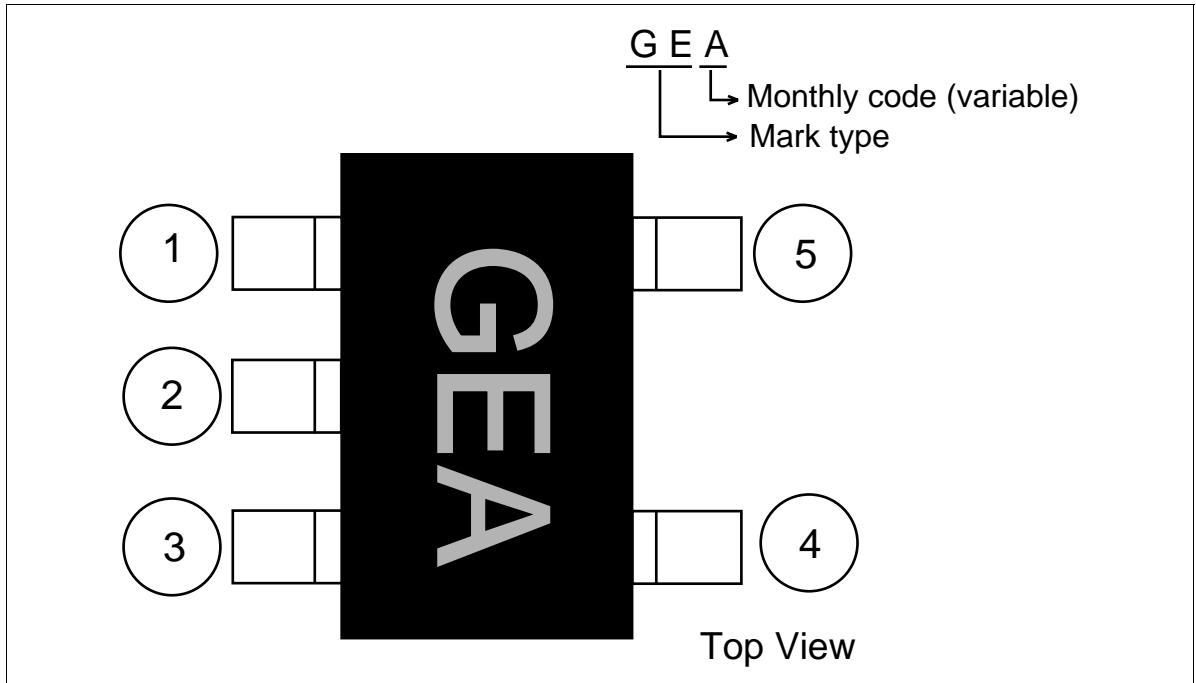

Pin No.	Pin name	Function
1	RF out	RF output
2	GND	Ground
3	Cs	Bypass capacitor (>100 pF)
4	RF in	RF input
5	Vdd	Power supply

Pattern Layout

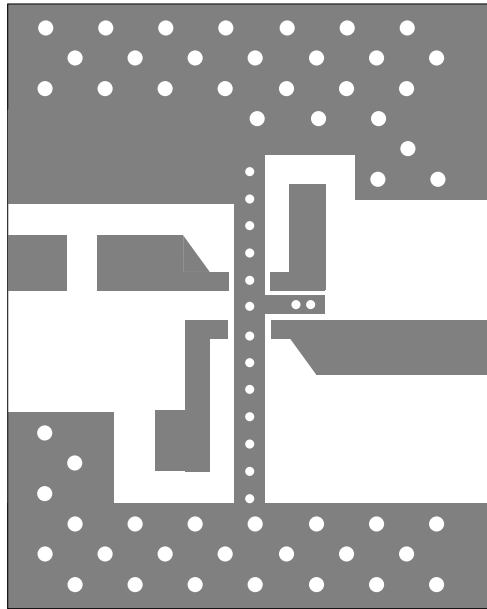

Front Side view of PCB Pattern

scale 4/1

- : $\phi 0.5\text{mm}$
- : $\phi 0.3\text{mm}$

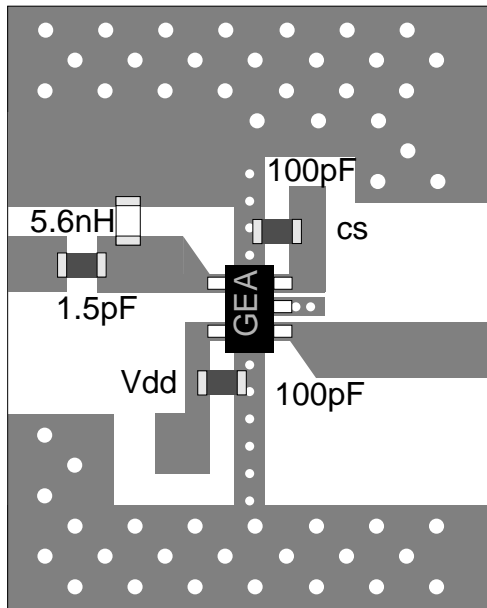

Front Side view of Part Layout(1.5GHz)

scale 4/1

■ : Capacitor

□ : Inductor

ER=4.8

H=1mm

Main Characteristics

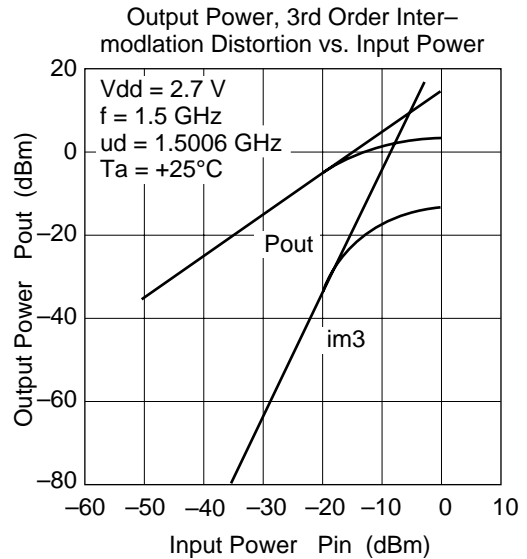
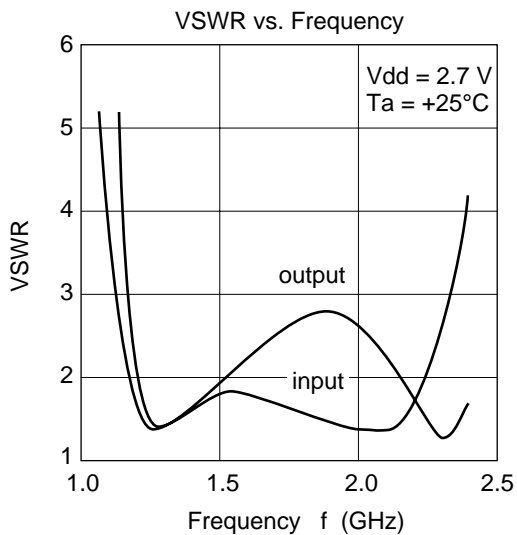
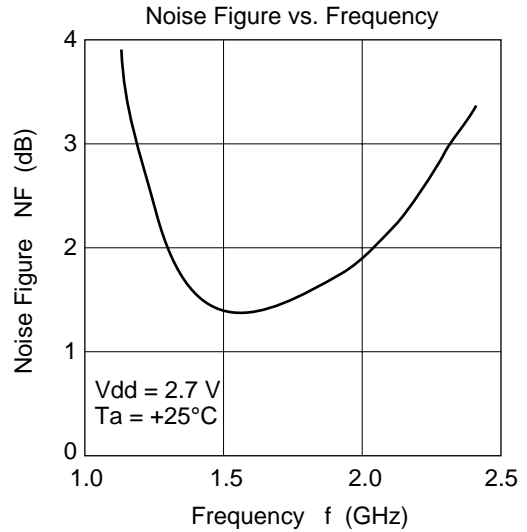
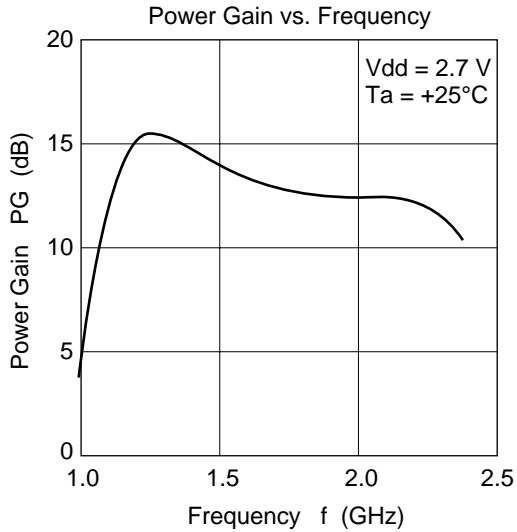

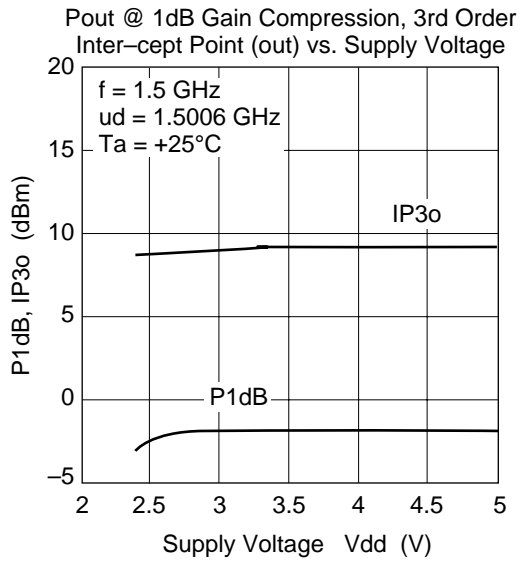
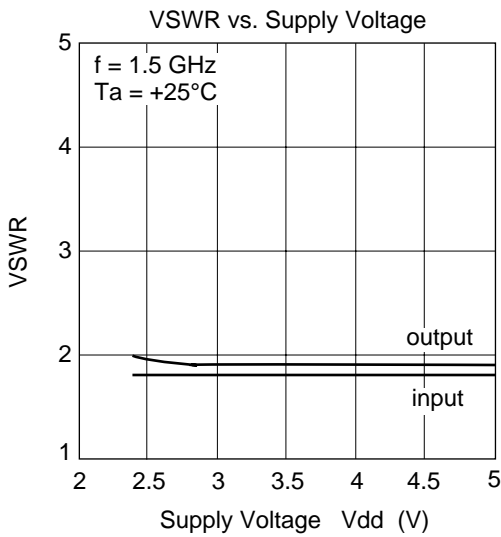
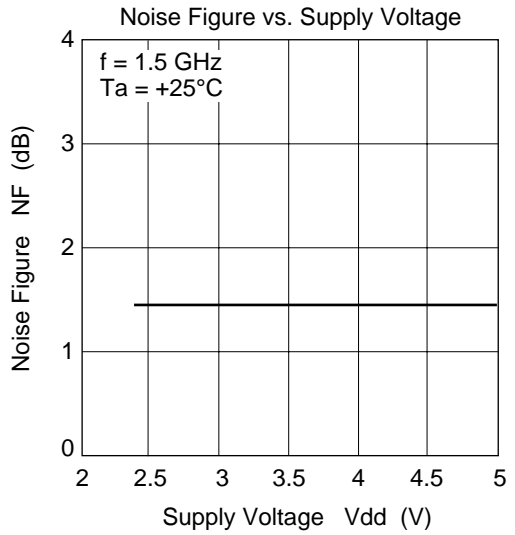
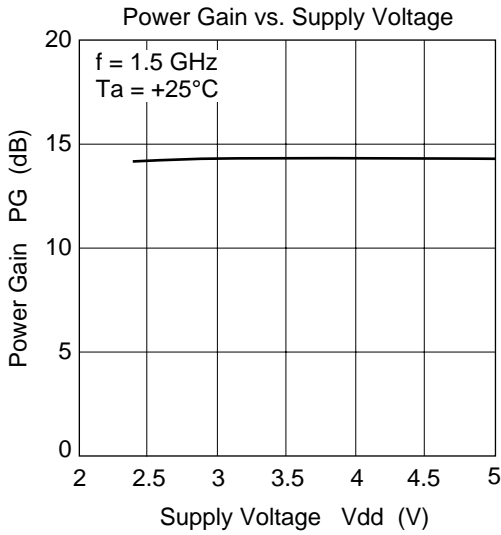

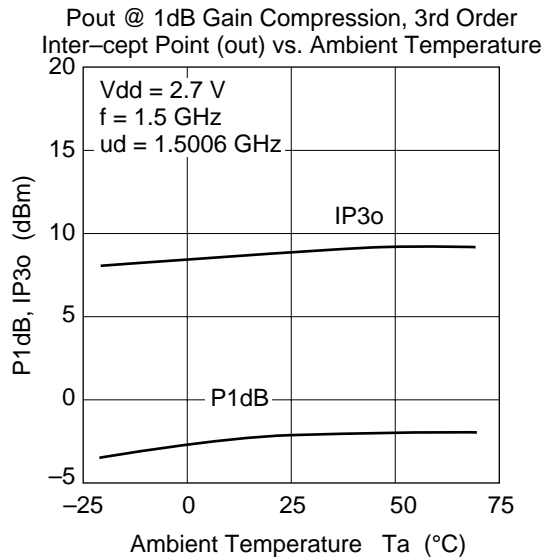
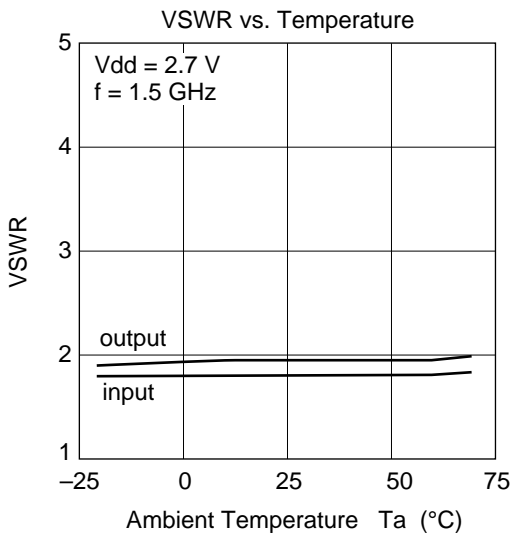
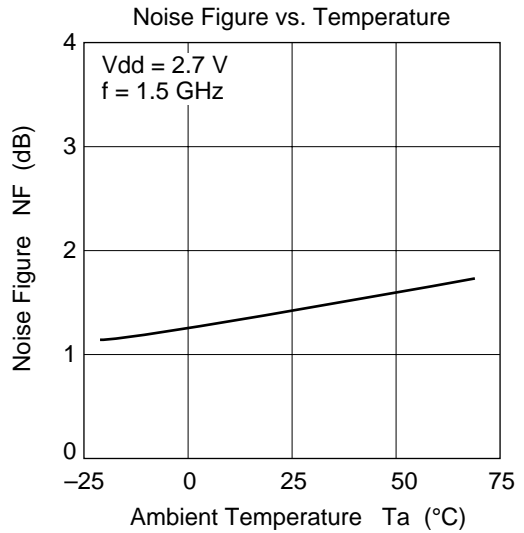
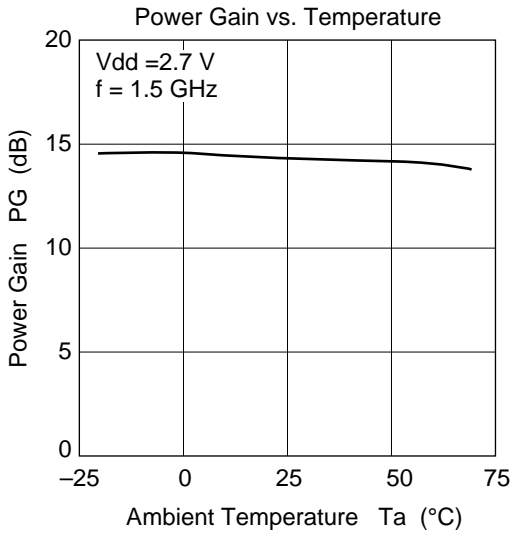

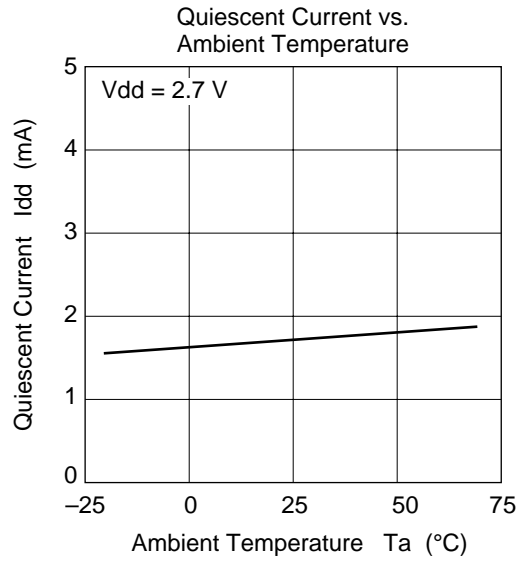
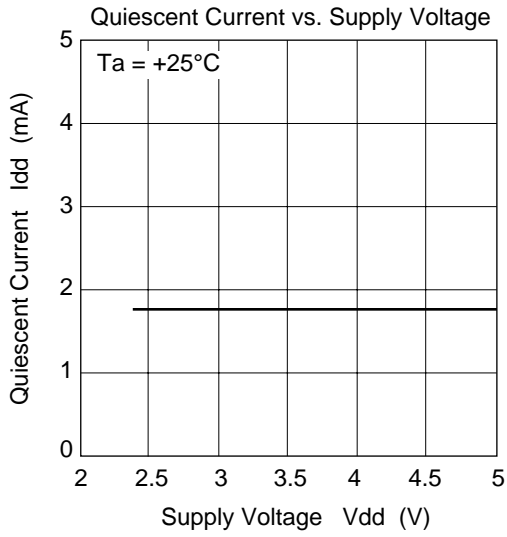

HA22033

Package Dimentions

Unit: mm

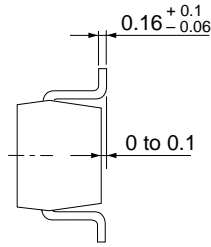
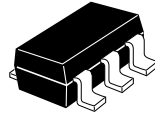
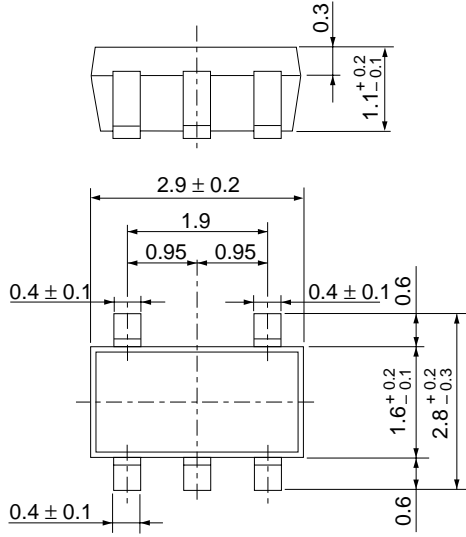

Hitachi code	MPAK-5
EIAJ	—
JEDEC	—

Cautions

1. Hitachi neither warrants nor grants licenses of any rights of Hitachi's or any third party's patent, copyright, trademark, or other intellectual property rights for information contained in this document. Hitachi bears no responsibility for problems that may arise with third party's rights, including intellectual property rights, in connection with use of the information contained in this document.
2. Products and product specifications may be subject to change without notice. Confirm that you have received the latest product standards or specifications before final design, purchase or use.
3. Hitachi makes every attempt to ensure that its products are of high quality and reliability. However, contact Hitachi's sales office before using the product in an application that demands especially high quality and reliability or where its failure or malfunction may directly threaten human life or cause risk of bodily injury, such as aerospace, aeronautics, nuclear power, combustion control, transportation, traffic, safety equipment or medical equipment for life support.
4. Design your application so that the product is used within the ranges guaranteed by Hitachi particularly for maximum rating, operating supply voltage range, heat radiation characteristics, installation conditions and other characteristics. Hitachi bears no responsibility for failure or damage when used beyond the guaranteed ranges. Even within the guaranteed ranges, consider normally foreseeable failure rates or failure modes in semiconductor devices and employ systemic measures such as fail-safes, so that the equipment incorporating Hitachi product does not cause bodily injury, fire or other consequential damage due to operation of the Hitachi product.
5. This product is not designed to be radiation resistant.
6. No one is permitted to reproduce or duplicate, in any form, the whole or part of this document without written approval from Hitachi.
7. Contact Hitachi's sales office for any questions regarding this document or Hitachi semiconductor products.

1. This product must not be placed in the mouth, as it contains toxic substances that may cause poisoning. If by chance the product is placed in the mouth, take emergency action such as inducing vomiting, then consult a physician without delay.
2. Disposal of this product must be handled, separately from other general refuse, by a specialist processing contractor in the same way as dangerous items.

HITACHI

Hitachi, Ltd.

Semiconductor & IC Div.
Nippon Bldg., 2-6-2, Ohte-machi, Chiyoda-ku, Tokyo 100-0004, Japan
Tel: Tokyo (03) 3270-2111 Fax: (03) 3270-5109

URL NorthAmerica : <http://semiconductor.hitachi.com/>
 Europe : <http://www.hitachi-eu.com/hel/ecg>
 Asia (Singapore) : <http://www.has.hitachi.com.sg/grp3/sicd/index.htm>
 Asia (Taiwan) : http://www.hitachi.com.tw/E/Product/SICD_Frame.htm
 Asia (HongKong) : <http://www.hitachi.com.hk/eng/bo/grp3/index.htm>
 Japan : <http://www.hitachi.co.jp/Sicd/indx.htm>

For further information write to:

Hitachi Semiconductor
(America) Inc.
2000 Sierra Point Parkway
Brisbane, CA 94005-1897
Tel: <1> (800) 285-1601
Fax: <1> (303) 297-0447

Hitachi Europe GmbH
Electronic components Group
Dornacher Straße 3
D-85622 Feldkirchen, Munich
Germany
Tel: <49> (89) 9 9180-0
Fax: <49> (89) 9 29 30 00

Hitachi Europe Ltd.
Electronic Components Group.
Whitebrook Park
Lower Cookham Road
Maidenhead
Berkshire SL6 8YA, United Kingdom
Tel: <44> (1628) 585000
Fax: <44> (1628) 778322

Hitachi Asia Pte. Ltd.
16 Collyer Quay #20-00
Hitachi Tower
Singapore 049318
Tel: 535-2100
Fax: 535-1533

Hitachi Asia Ltd.
Taipei Branch Office
3F, Hung Kuo Building, No.167,
Tun-Hwa North Road, Taipei (105)
Tel: <886> (2) 2718-3666
Fax: <886> (2) 2718-8180

Hitachi Asia (Hong Kong) Ltd.
Group III (Electronic Components)
7/F., North Tower, World Finance Centre,
Harbour City, Canton Road, Tsim Sha Tsui,
Kowloon, Hong Kong
Tel: <852> (2) 735 9218
Fax: <852> (2) 730 0281
Telex: 40815 HITEC HX