

Power Inductors

Model HA72L-1250 series



Features:

- Operating Temperature Range -55°C to $+155^{\circ}\text{C}$
- Ambient Temperature, Maximum $+115^{\circ}\text{C}$
- Temperature Rise, 40°C
- RoHS Compliant
- AEC-Q200 Certified

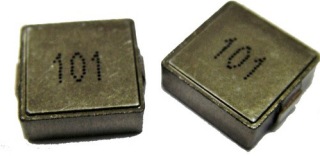

Schematic

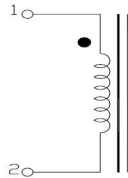

Specifications @ 25°C

Part Number	Inductance ($\mu\text{H} \pm 20\%$ @0A)	DCR (m Ω) Typ	DCR (m Ω) Max	I _{rms} (A)	Isat (A)	Part Number	Inductance ($\mu\text{H} \pm 20\%$ @0A)	DCR (m Ω) Typ.	DCR (m Ω) Max	I _{rms} (A)	Isat (A)
HA72L-1250R10LFTR	0.10	0.53	0.60	55.0	80	HA72L-12502R7LFTR	2.70	5.70	6.80	18.0	32.0
HA72L-1250R22LFTR	0.22	0.64	0.80	51.0	80	HA72L-12503R3LFTR	3.30	7.70	9.20	15.0	32.0
HA72L-1250R33LFTR	0.33	0.85	1.20	42.0	80	HA72L-12504R7LFTR	4.70	12.80	15.00	12.0	27.0
HA72L-1250R47LFTR	0.47	1.10	1.30	38.0	65.0	HA72L-12505R6LFTR	5.60	14.00	16.50	11.5	22.0
HA72L-1250R56LFTR	0.56	1.30	1.60	36.0	55.0	HA72L-12506R8LFTR	6.80	15.40	18.50	11.0	21.0
HA72L-1250R68LFTR	0.68	1.50	1.70	34.0	54.0	HA72L-12507R8LFTR	7.80	17.20	20.50	10.0	18.0
HA72L-1250R82LFTR	0.82	2.00	2.30	31.0	53.0	HA72L-12508R2LFTR	8.20	18.90	22.50	9.5	18.0
HA72L-12501R0LFTR	1.00	2.10	2.50	29.0	50.0	HA72L-1250100LFTR	10.0	21.40	25.50	9.0	16.0
HA72L-12501R2LFTR	1.20	2.80	3.50	25.0	49.0	HA72L-1250150LFTR	15.0	44.00	48.00	6.0	9.0
HA72L-12501R5LFTR	1.50	3.40	4.10	23.0	38.0	HA72L-1250220LFTR	22.0	50.00	58.00	5.5	8.0
HA72L-12501R8LFTR	1.80	4.20	4.90	19.0	35.0	HA72L-1250330LFTR	33.0	75.00	84.00	3.5	6.0
HA72L-12502R2LFTR	2.20	4.60	5.50	20.0	32.0	HA72L-1250470LFTR	47.0	138.00	152.00	2.0	4.0

- Notes: (1) Isat is the saturation current at which inductance rolls off approximately 30% from its initial (zero DC)
 (2) I_{rms} is the approximate current at which $\Delta T = 40^{\circ}\text{C}$
 (3) Operating Temperature Range -55°C to $+155^{\circ}\text{C}$
 (4) Test condition for all case sizes is 100kHz @ 1V

General Note

TT Electronics reserves the right to make changes in product specification without notice or liability. All information is subject to TT Electronics' own data and is considered accurate at time of going to print.

TT Electronics | BI Technologies
 A-1445, Jalan Tanjung Api

25050 Kuantan Pahang Darul Makmur, Malaysia | Ph: +60 9 565 8888
www.ttelectronicsmagnetics.com/customer-service-enquiry

Electrical Specifications @ 25°C

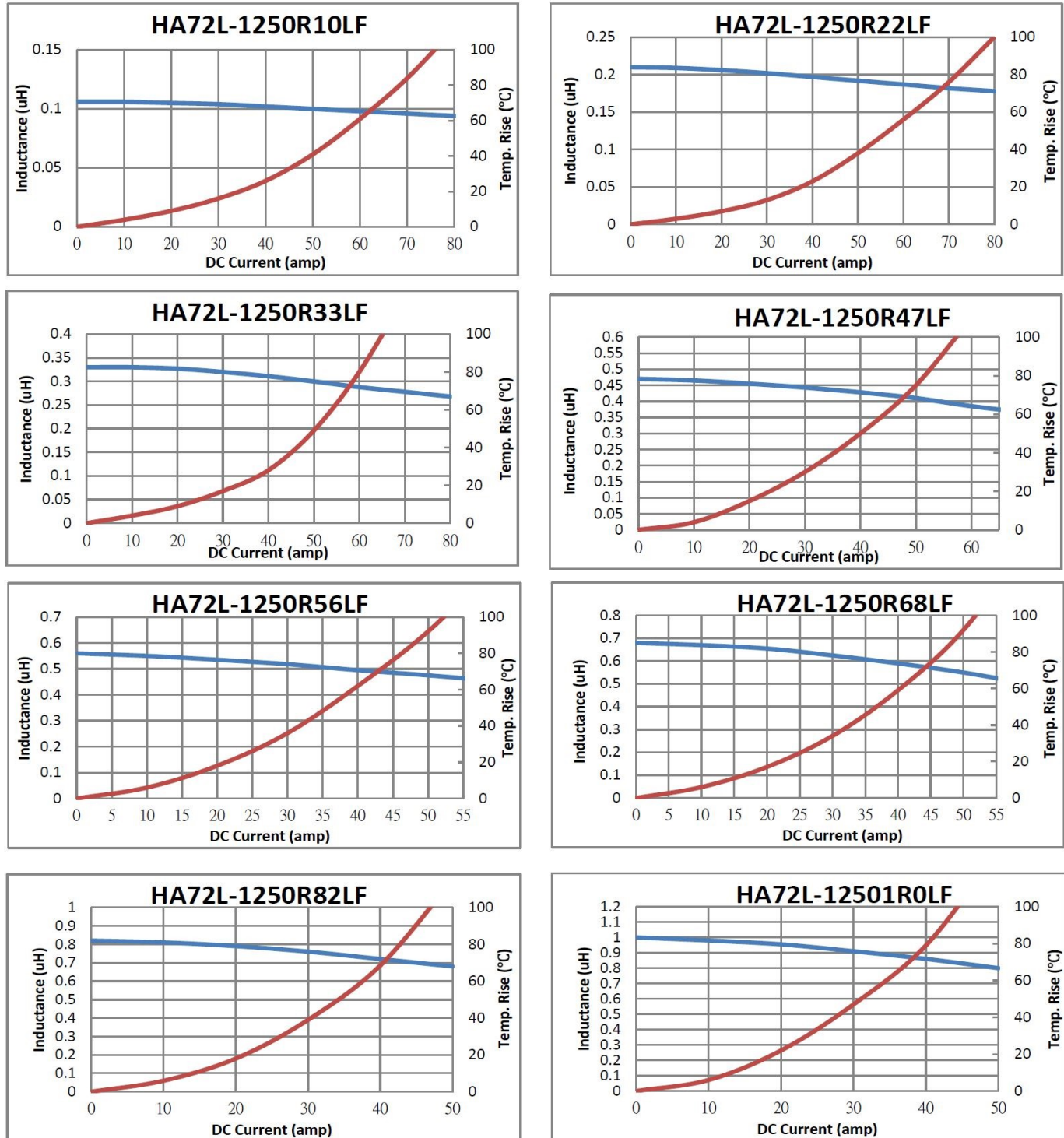

General Note
 TT Electronics reserves the right to make changes in product specification without notice or liability. All information is subject to TT Electronics' own data and is considered accurate at time of going to print.

TT Electronics | BI Technologies
 A-1445, Jalan Tanjung Api
 25050 Kuantan Pahang Darul Makmur, Malaysia | Ph: +60 9 565 8888
www.ttelectronicsmagnetics.com/customer-service-enquiry

Electrical Characteristics

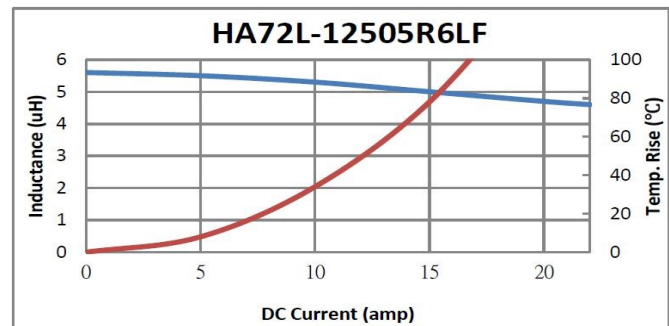
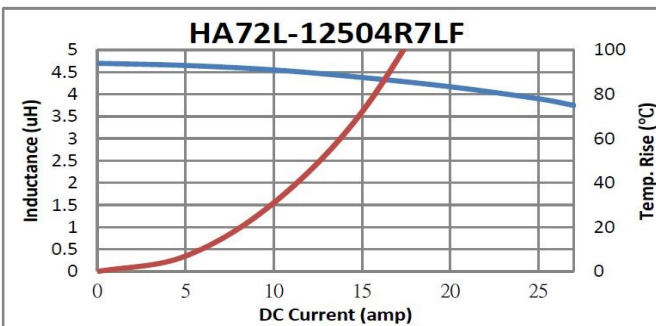
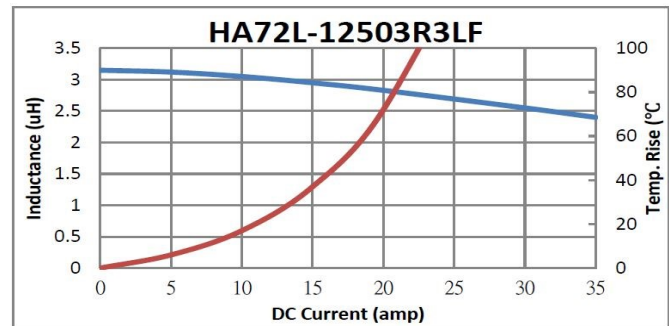
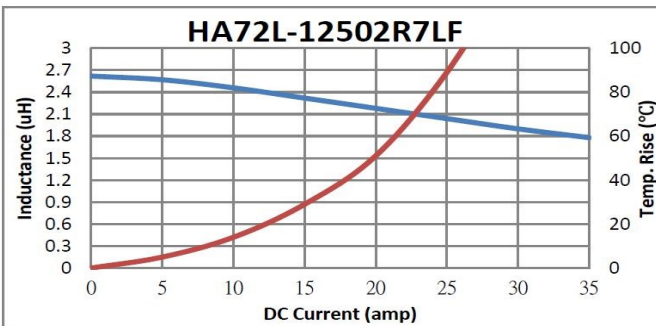
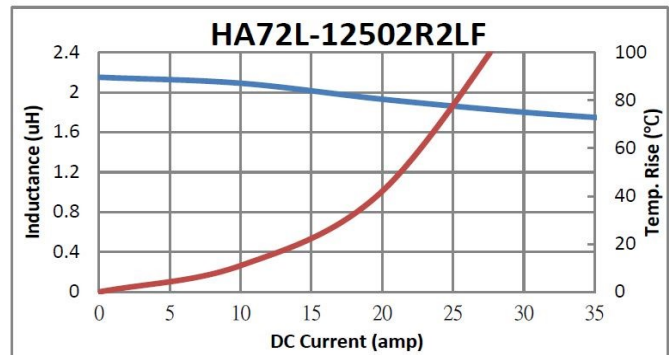
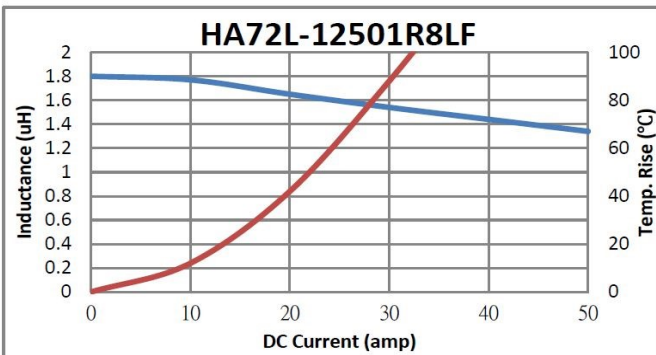
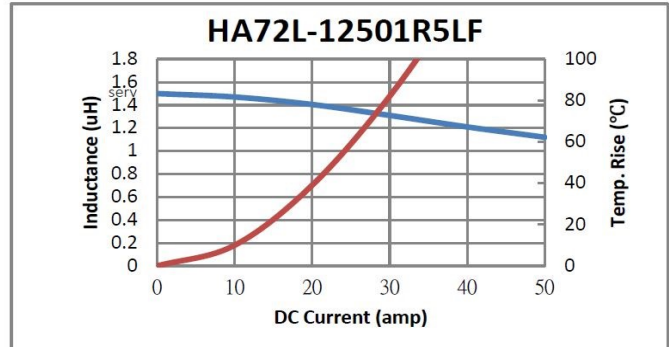
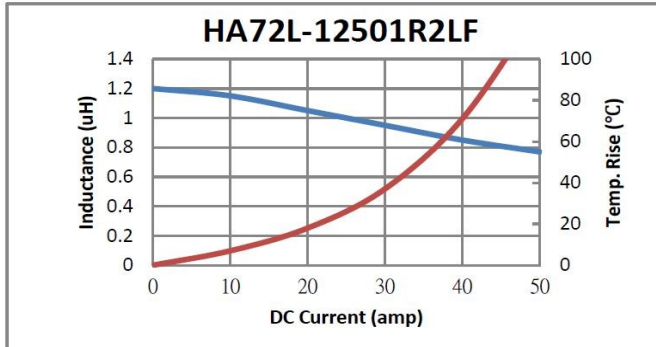

General Note
 TT Electronics reserves the right to make changes in product specification without notice or liability. All information is subject to TT Electronics' own data and is considered accurate at time of going to print.

TT Electronics | BI Technologies
 A-1445, Jalan Tanjung Api
 25050 Kuantan Pahang Darul Makmur, Malaysia | Ph: +60 9 565 8888
www.ttelectronicsmagnetics.com/customer-service-enquiry

Electrical Characteristics

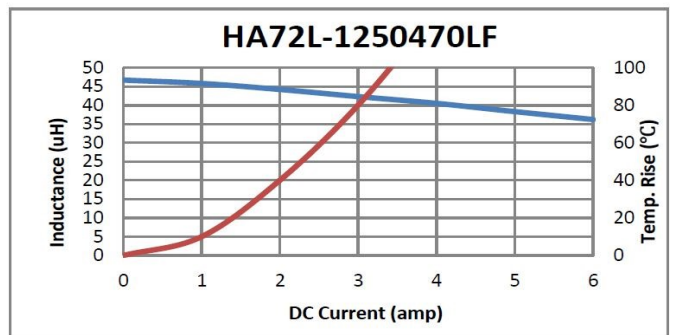
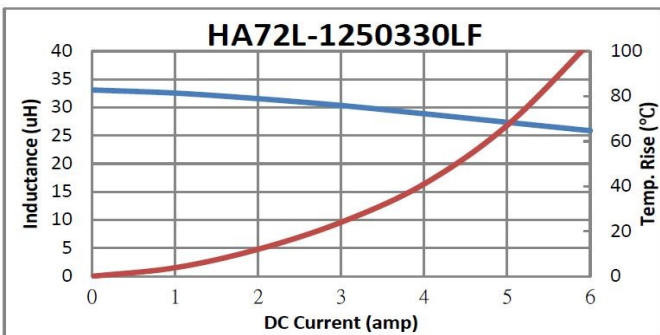
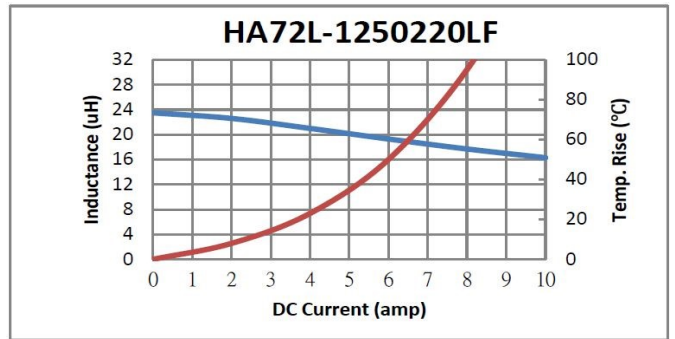
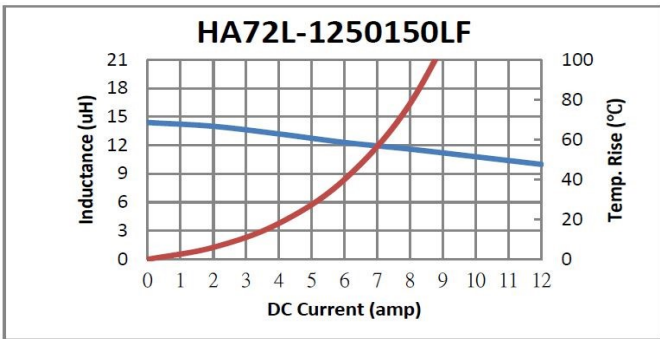
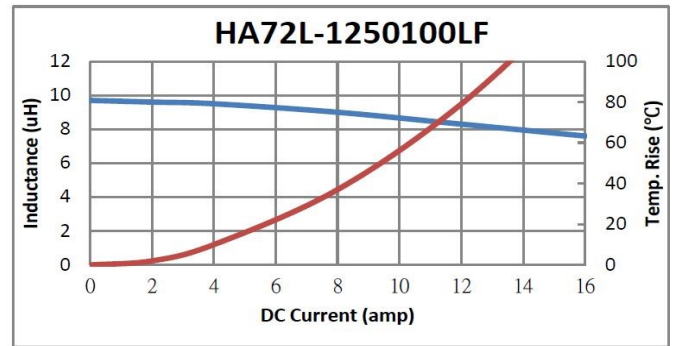
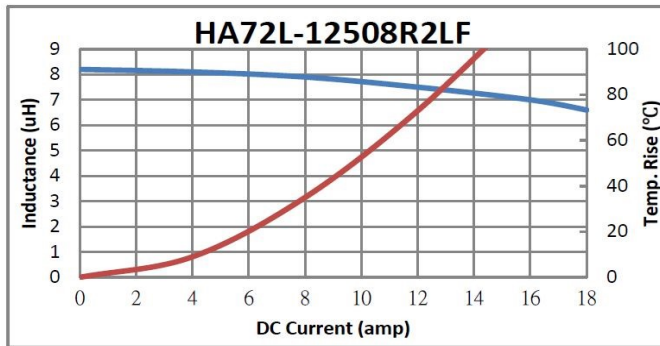
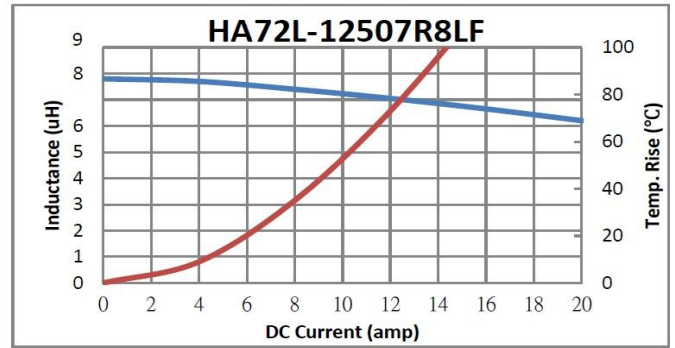
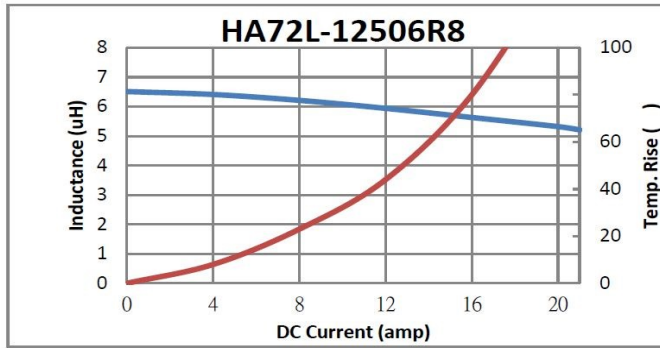

General Note
 TT Electronics reserves the right to make changes in product specification without notice or liability. All information is subject to TT Electronics' own data and is considered accurate at time of going to print.

TT Electronics | BI Technologies
 A-1445, Jalan Tanjung Api
 25050 Kuantan Pahang Darul Makmur, Malaysia | Ph: +60 9 565 8888
www.ttelectronicsmagnetics.com/customer-service-enquiry

Outline Dimensions (mm)

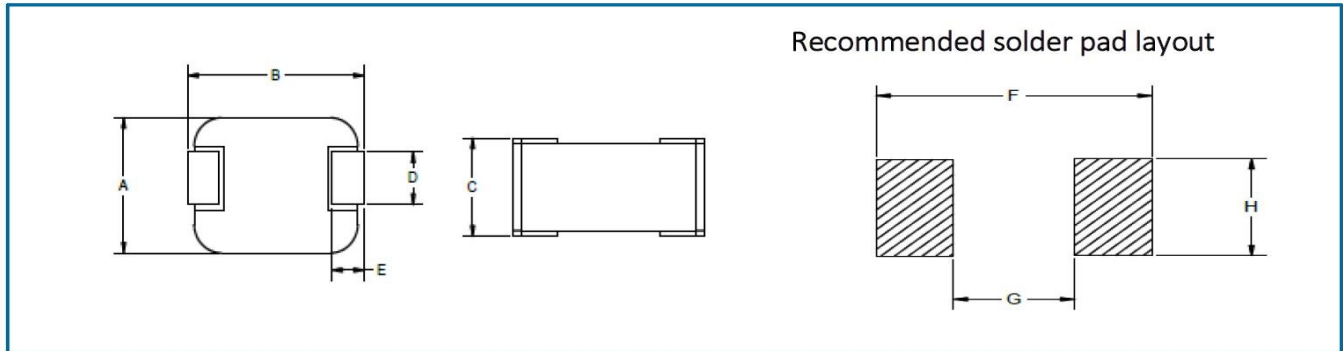

CASE SIZE	A(mm)	B(mm)	C(mm)	D(mm)	E(mm)	F(mm)	G(mm)	H(mm)
1250 series	12.8 ± 0.3	13.5 ± 0.5	5	3.5 ± 0.5	2.5 ± 0.5	15	6	5

Packaging

Standard:	Embossed Tape and Reel		
	Reel:	Diameter	All case size = 13" (330mm)
		Capacity	Case size 1250 = 500 units

Ordering Information

HA72L – XXXX XXX LF TR XX

