



AB类/D类切换, 2种防破音模式可选, 10W输出功率, 单通道音频功率放大器

概要

HAA9202是一款FM无干扰、带防破音AB/D类可切换、高效率、无滤波器的10W单声道音频功率放大器。超低的EMI非常适合应用于带FM功能的便携式设备中。

HAA9202的单端输入架构和极高的PSRR有效地提高了HAA9202对RF噪声的抑制能力。无需滤波器的PWM调制结构及增益内置方式减少了外部元件、PCB面积和系统成本,并简化了设计。高达90%的效率,快速地启动时间和纤小的封装尺寸使得HAA9202成为便携式音频产品的最佳选择。

HAA9202具有极低的关断电流,极大的延长系统的待机时间。OCP、OTP、UVLO保护功能增强系统的可靠性。开启、关闭POP-click抑制功能改善了系统的听觉感受,同时简化系统调试。

HAA9202提供带散热片的ESOP8封装

特性

- AB类、D类切换功能
- 2种防破音模式可选, 防破音压缩范围-10dB
- D类输出功率:
 - 10.5W (VDD=6.6V, RL =2Ω, THD+N=10%)
 - 5.5W (VDD=6.6V, RL =4Ω, THD+N=10%)
- AB类输出功率:
 - 10.4W (VDD=6.6V, RL =2Ω, THD+N=10%)
 - 5.4W (VDD=6.6V, RL =4Ω, THD+N=10%)
- 工作电压: 2.5V to 6.6V
- 低失真和低噪声
- 开启、关闭POP-click抑制功能
- 关断电流 (<1uA)
- OCP、OTP、UVLO保护功能

应用

- 扩音器
- 便携式音箱 / 插卡音箱
- 蓝牙音箱 / USB音箱

典型应用电路图

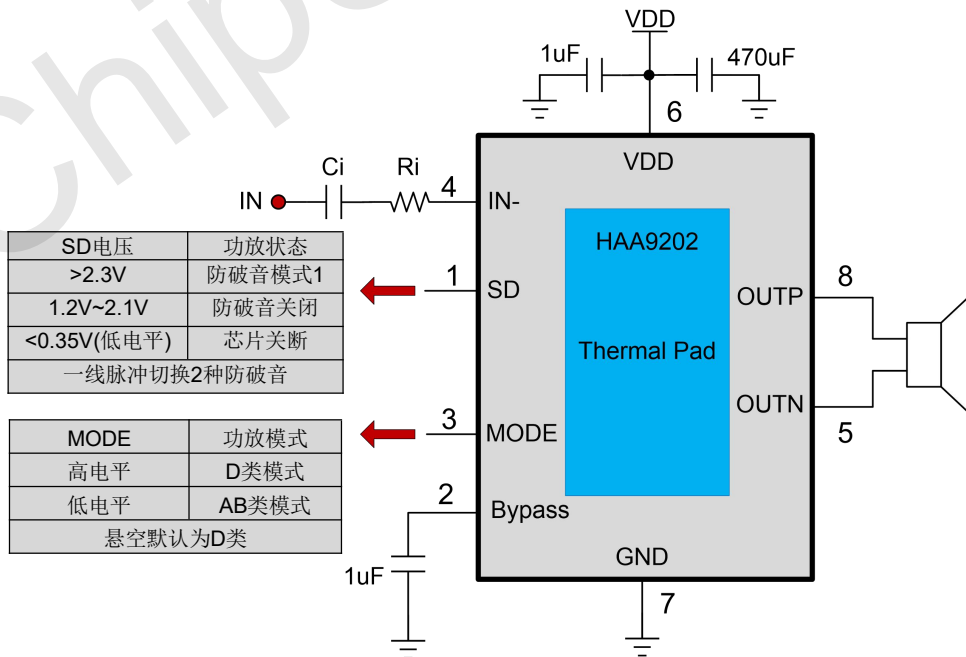



AB 类/D 类切换,2 种防破音模式可选,10W 输出功率,单通道音频功率放大器

引脚排列

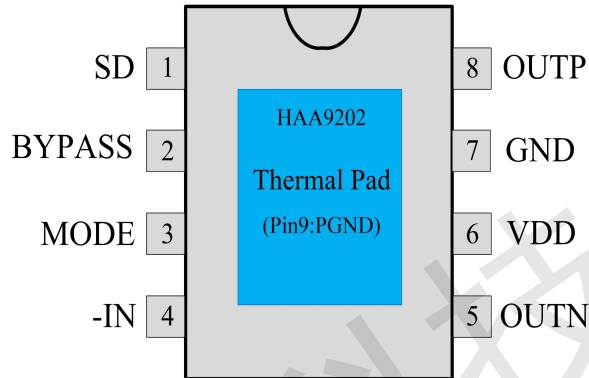

管脚描述

管脚	符号	I/O	描述
1	SD	I	系统关断控制 (SD 电压大于 2.3V 工作在防破音模式 1, SD 电压在 1.2V~2.1V 防破音关闭, SD 电压小于 0.35V, 芯片关断, 同时具有一线脉冲切换 2 种防破音模式的功能)
2	BYPASS	I	参考电压
3	MODE	I/O	D 类, AB 类选择, 悬空默认为 D 类
4	-IN	I	音频负输入端
5	OUTN	O	音频负输出端
6	VDD		电源
7	GND		地
8	OUTP	O	音频正输出端
9(Thermal Pad)	GND		芯片底部散热片接地



AB类/D类切换, 2种防破音模式可选, 10W输出功率, 单通道音频功率放大器

订购信息

料号	封装	表面印字	包装
HAA9202	ESOP8	HAA9202 (A) PST XXXXXXX	100颗/管 (管装)
HAA9202	ESOP8	HAA9202 (A) PST XXXXXXX	4000颗/盘 (卷带)

极限参数表

参数	描述	数值	单位
VIN	无信号输入时供电电源	7.5	V
VI	输入电压	-0.3 to VIN+0.3	V
TA	工作温度	-40°C to 85°C	°C
TJ	结温	-40°C to 150°C	°C
TSTG	储存温度	-65°C to 150°C	°C
TSLD	焊接温度	300°C, 10sec	°C

推荐的工作条件

Symbol	Parameter	Test Conditions	MIN	MAX	UNIT
VDD	供电电压	VDD	2.5	6.6	V
VIH	SD高电平 (防破音模式1)	VDD=2.5V to 6.6V	2.3	6.6	V
	SD高电平 (防破音模式关)		1.2	2.1	V
	MODE高电平		2		V
VIL	SD低电平	VDD=2.5V to 6.6V		0.35	V
	MODE低电平			0.35	V

热效应参数

Parameter	Symbol	Package	MAX	UNIT
热阻 (Junction to Ambient)	θ_{JA}	ESOP8	40	°C/W
热阻 (Junction to Case)	θ_{JC}	ESOP8	11	°C/W



AB类/D类切换, 2种防破音模式可选, 10W输出功率, 单通道音频功率放大器

D类 电气特性 (Gain=23dB, $R_L=4\Omega$, $T=25^\circ\text{C}$, 防破音关闭, 除非特殊说明.)

Symbol	Parameter	Test Conditions	MIN	TYP	MAX	UNIT
P _o		THD+N=10%, f=1KHZ, R _L =4Ω	V _{DD} =6.6V	5.5		W
			V _{DD} =5.0V	3.2		
			V _{DD} =3.7V	1.7		
		THD+N=1%, f=1KHZ, R _L =4Ω	V _{DD} =6.6V	4.6		W
			V _{DD} =5.0V	2.7		
			V _{DD} =3.6V	1.4		
		THD+N=10%, f=1KHZ, R _L =2Ω	V _{DD} =6.6V	10.5		W
			V _{DD} =5.0V	5.3		
			V _{DD} =3.7V	2.8		
		THD+N=1%, f=1KHZ, R _L =2Ω	V _{DD} =6.6V	8.7		W
			V _{DD} =5.0V	4.3		
			V _{DD} =3.7V	2.2		
THD+N	D类防破音模式关闭输出功率	V _{DD} =6.6V, P _o =2W, R _L =4Ω	f=1KHz	0.04		%
		V _{DD} =5.0V, P _o =1W, R _L =4Ω		0.1		
		V _{DD} =3.7V, P _o =1W, R _L =4Ω		0.28		
		V _{DD} =6.6V, P _o =1W, R _L =2Ω	f=1KHz	0.07		%
		V _{DD} =5.0V, P _o =2W, R _L =2Ω		0.21		
		V _{DD} =3.7V, P _o =2W, R _L =2Ω		1.1		
G _v		R _i = 22K		23		dB
PSRR	电源纹波抑制比	V _{DD} =5V ±200mVp-p	f=217Hz	72		dB
SNR	信噪比	V _{DD} =5.0V, V _{rms} =1V, G _v =23dB	f=1KHz	-90		dB
V _n	残余噪声	V _{DD} =5.0V, Input floating with C _{IN} =0.1μF	A-weighting	75		μV
			No A-weighting	110		
Dyn	动态范围	V _{DD} =5.0V, THD=1%	f=1KHz	-90		dB
I _q	静态电流	V _{DD} =5.0V	No Load	4		mA
		V _{DD} =3.0V		3.6		
η	效率	V _{DD} =5V, R _L =4Ω, P _o =3W	f=1KHz	90		%
		V _{DD} =5V, R _L =2Ω, P _o =5W	f=1KHz	85		
Fosc	D类调制频率	V _{IN} =2.5V to 5.0V		600		kHz
R _{in}	内置输入电阻			5		KΩ
R _f	内置反馈电阻			400		KΩ
I _{SD}	关断电流	V _{IN} =0V, V _{DD} =5V		0.1	1	μA
V _{os}	失调电压	V _{IN} =0V, V _{DD} =5V		0	40	mV
T _{st}	启动时间	Bypass capacitor =1uF	V _{DD} =5V	160		mS
OTP	—	No Load, Junction Temperature	V _{DD} =5.0V	165		°C
OTH	—			35		



AB类/D类切换,2种防破音模式可选,10W输出功率,单通道音频功率放大器

AB类 电气特性(Gain=23dB, $R_L=4\Omega$, $T=25^\circ\text{C}$, 除非特殊说明.)

Symbol	Parameter	Test Conditions	MIN	TYP	MAX	UNIT	
P_o	AB类模式输出功率	THD+N=10%, f=1KHZ, $R_L=4\Omega$	$V_{DD}=6.6\text{V}$		5.4		W
			$V_{DD}=5.0\text{V}$		3.1		
			$V_{DD}=3.7\text{V}$		1.65		
		THD+N=1%, f=1KHZ, $R_L=4\Omega$	$V_{DD}=6.6\text{V}$		4.4		W
			$V_{DD}=5.0\text{V}$		2.65		
			$V_{DD}=3.6\text{V}$		1.4		
		THD+N=10%, f=1KHZ, $R_L=2\Omega$	$V_{DD}=6.6\text{V}$		10.4		W
			$V_{DD}=5.0\text{V}$		5.2		
			$V_{DD}=3.7\text{V}$		2.78		
		THD+N=1%, f=1KHZ, $R_L=2\Omega$	$V_{DD}=6.6\text{V}$		6.5		W
			$V_{DD}=5.0\text{V}$		4.15		
			$V_{DD}=3.6\text{V}$		2.2		
THD+N	总谐波失真+噪声	$V_{DD}=6.6\text{V}$, $P_o=2\text{W}$, $R_L=4\Omega$	f=1KHZ		0.1	%	
					0.09		
					0.23		
		$V_{DD}=6.6\text{V}$, $P_o=2\text{W}$, $R_L=2\Omega$	f=1KHZ		0.16	%	
					0.2		
					1.05		
G_v	D类模式增益	$R_i = 22\text{K}$		23		dB	
PSRR	电源纹波抑制比	$V_{DD}=5\text{V} \pm 200\text{mVp-p}$	f=217Hz	70		dB	
SNR	信噪比	$V_{DD}=6.6\text{V}$, $V_{\text{orms}}=1\text{V}$, $G_v=23\text{dB}$	f=1KHZ	-89		dB	
V_n	残余噪声	$V_{DD}=5.0\text{V}$, Input floating with $C_{IN}=0.1\mu\text{F}$	A-weighting	70		μV	
			No	105			
			A-weighting				
Dyn	动态范围	$V_{DD}=6.6\text{V}$, THD=1%	f=1KHZ	-89		dB	
I_q	静态电流	$V_{DD}=5.0\text{V}$	No Load		4.2	mA	
		$V_{DD}=3.0\text{V}$			3.8		
R_{in}	内置输入电阻			5		K Ω	
R_f	内置反馈电阻			400		K Ω	
I_{SD}	关断电流	$V_{IN}=0\text{V}$, $V_{DD}=5\text{V}$		0.1	1	μA	
V_{os}	失调电压	$V_{IN}=0\text{V}$, $V_{DD}=5\text{V}$		0	40	mV	
Tst	启动时间	Bypass capacitor = 1uF	$V_{DD}=5\text{V}$	160		mS	
OTP	—	No Load, Junction Temperature	$V_{DD}=5.0\text{V}$		165	$^\circ\text{C}$	
OTH	—				35		



AB类/D类切换,2种防破音模式可选,10W输出功率,单通道音频功率放大器

电气特性($R_i=22K\Omega$, $C_i=0.1\mu F$, $R_L=4\Omega$, $f=1KHZ$ $T=25^\circ C$, 防破音模式1, 除非特殊说明.)

Symbol	Parameter	Test Conditions	MIN	TYP	MAX	UNIT
P _o	防破音模式1 输出功率	VIN=6.6V,V _{po} =330mV, ,R _L =4 Ω,NCN MODE1		4.3		W
		VIN=5V,V _{po} =250mV, ,R _L =4 Ω,NCN MODE1		2.5		
THD+N	总谐波失真+噪声	VIN=6.6V,V _{po} =330mV, ,R _L =4 Ω,NCN MODE1		0.92		%
		VIN=5V,V _{po} =250mV, ,R _L =4 Ω,NCN MODE1		0.89		
Tat	防破音启动时间			95		mS
Trl	防破音释放时间			525		mS

电气特性($R_i=22K\Omega$, $C_i=0.1\mu F$, $R_L=4\Omega$, $f=1KHZ$ $T=25^\circ C$, 防破音模式2, 除非特殊说明.)

Symbol	Parameter	Test Conditions	MIN	TYP	MAX	UNIT
P _o	防破音模式2 输出功率	VIN=6.6V,V _{po} =330mV, ,R _L =4 Ω,NCN MODE2		4.35		W
		VIN=5V,V _{po} =250mV, ,R _L =4 Ω,NCN MODE2		2.53		
THD+N	总谐波失真+噪声	VIN=6.6V,V _{po} =330mV, ,R _L =4 Ω,NCN MODE2		0.9		%
		VIN=5V,V _{po} =250mV, ,R _L =4 Ω,NCN MODE2		0.88		
Tat	防破音启动时间			60		mS
Trl	防破音释放时间			350		mS



AB类/D类切换, 2种防破音模式可选, 10W输出功率, 单通道音频功率放大器

典型特征曲线 (D类工作模式, Gain=23dB, $R_L=4\Omega$, $T=25^\circ\text{C}$, 除非特殊说明.)

THD+N vs Output Power

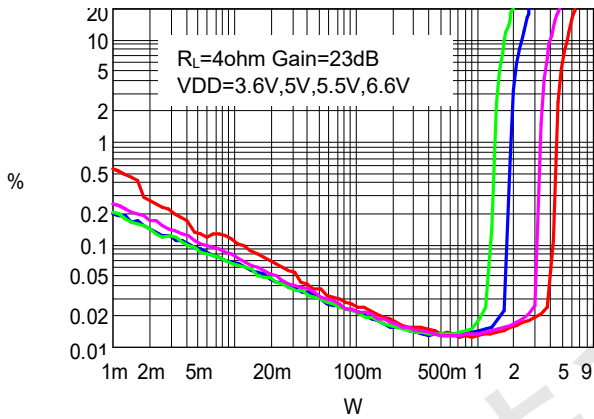

THD+N vs Output Power

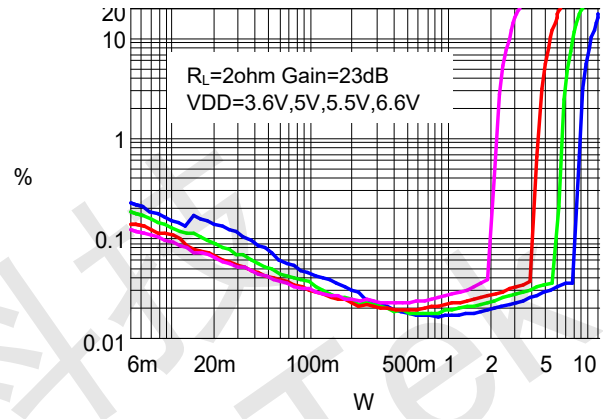

THD+N VS Frequency

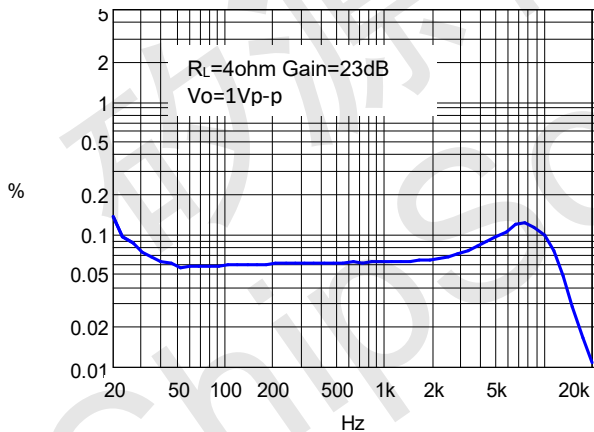

Frequency Response

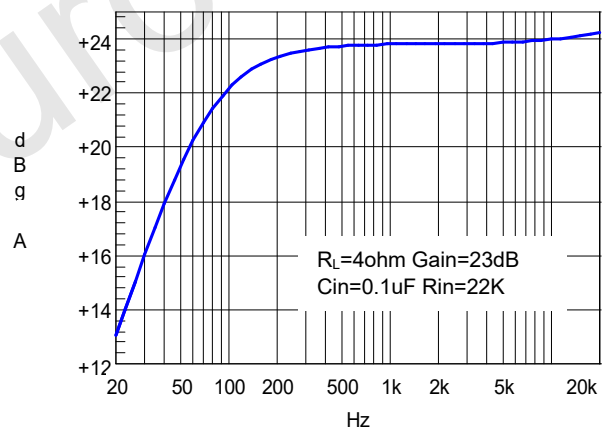

NOISE FLOOR FF

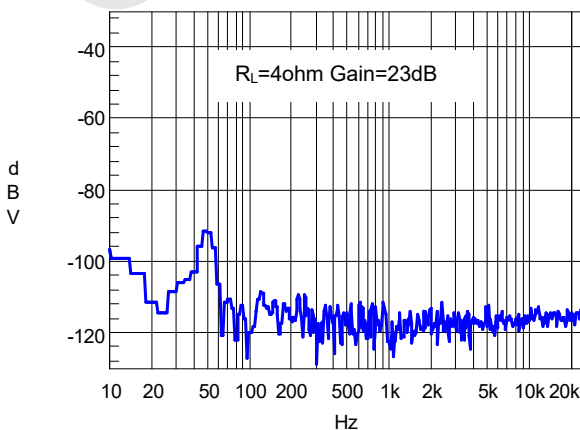



AB类/D类切换,2种防破音模式可选,10W输出功率,单通道音频功率放大器

典型特征曲线(AB类工作模式, Gain=23dB, $R_L=4\Omega$, $T=25^\circ\text{C}$, 除非特殊说明.)

THD+N vs Output Power

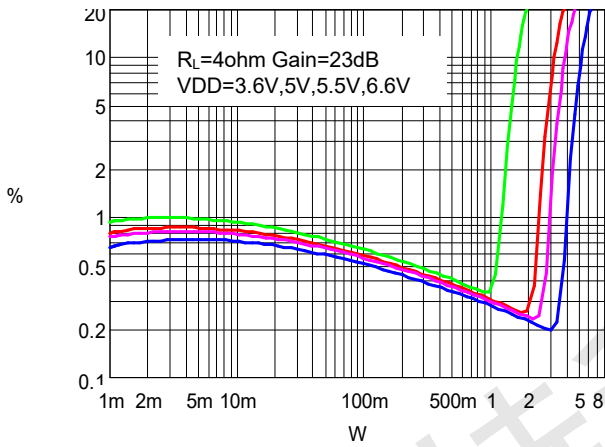

THD+N vs Output Power

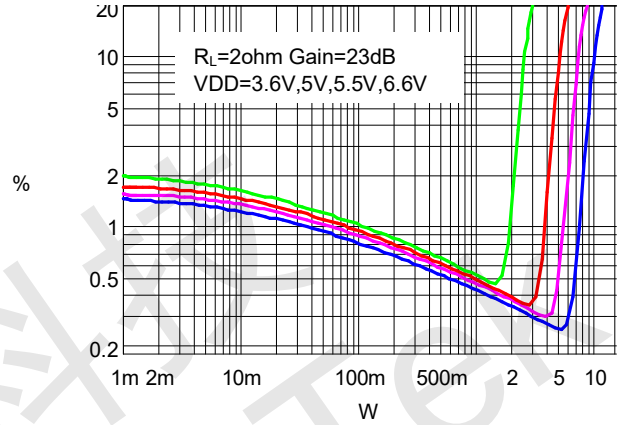

THD+N VS FREQUENCY

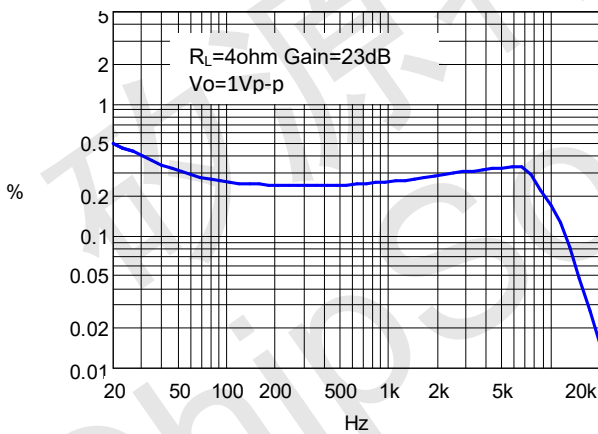

Frequency Response

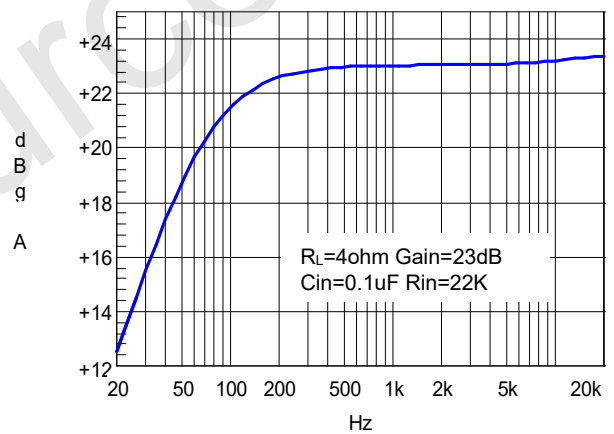

NOISE FLOOR FFT

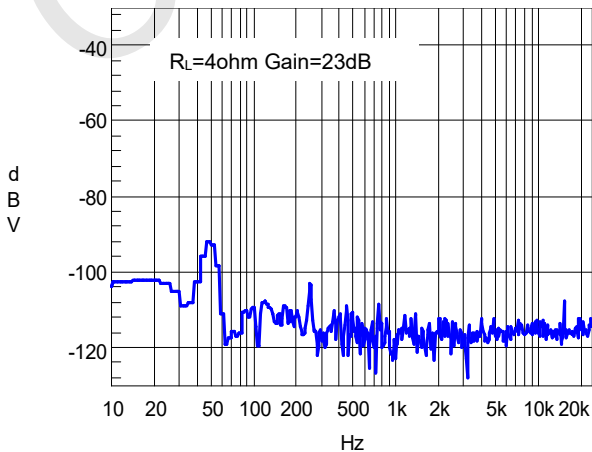



AB类/D类切换,2种防破音模式可选,10W输出功率,单通道音频功率放大器

应用信息

MODE管脚控制

AB类, D类切换控制功能使用功放的第3管脚来控制。MODE管脚置高电平时HAA9202工作在D类的模式; MODE管脚置低电平时HAA9202工作在AB类的模式。

输入电阻(Ri)

HAA9202的增益由音量调节控制的输入电阻(RI)和反馈电阻(RF)控制。增益计算公式:

$$A_v = \frac{R_f}{R_i + 5} \left(\frac{V}{V} \right)$$

其中, 输入电阻RI为外部的输入电阻 (HAA9202内部集成输入电阻为5KΩ), 反馈电阻Rf为400KΩ (反馈电阻为内部固定, 不可外部调节)。例如, 外部输入电阻为22K, 则放大倍数为:

$$A_v = 400 / (22+5) = 14.8 \text{ 倍} = 23.4 \text{ dB}$$

输入电容 (Ci)

输入电容与输入电阻构成一个高通滤波器, 其截止频率可由下式得出:

$$f_c = \frac{1}{(2\pi R_i C_i)}$$

Ci的值不仅会影响到电路的低频响应, 而且也会影响到电路启动和关断时所产生的POP声, 输入电容越大, 则到达其稳定工作点所需的电荷越多, 在同等条件下, 小的输入电容所产生的POP声比较小。

偏置电容CBYP

偏置电容是最关键的电容, 它与几个重要性能相关, 当电路启动时, 偏置电容决定了放大器的开启速度, 偏置电容同时会影响到电路的噪声, 电源抑制比以及开关机的POP声。

为避免启动时的POP声, 偏置电压的上升速度应该比输入偏置电压的上升速度慢。

SD管脚控制

为了减少在关断模式下的功率损耗, HAA9202带有关闭放大器偏置的关断电路。当SD管脚电压小于0.35V, 芯片关断, 工作电流达到最小。当SD管脚电压在1.2V~2.1V则HAA9202进入D类防破音关闭的模式。当SD管脚直接拉高且电压大于2.3V, 不输入一线脉冲信号, HAA9202默认进入到D类防破音模式1。如果SD管脚输入一线脉冲信号, 则HAA9202进入到相对应的工作模式。

一线脉冲控制方式如下:

1. 切换到D类防破音模式1的波形



2. 切换到D类防破音模式2的波形

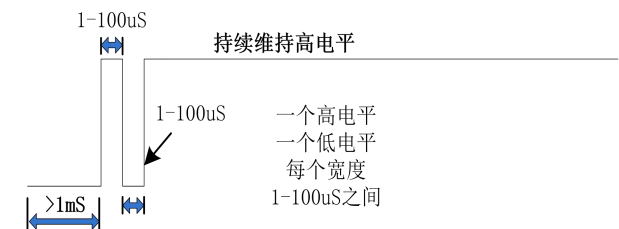

过温保护

HAA9202 有过温保护电路以防止内部温度超过165°C时器件损坏。在不同器件之间, 这个值有25°C的差异。当内部电路超过设置的保护温度时, 器件进入关断状态, 输出被截止。当温度下降 30°C后, 器件重新正常工作。



AB类/D类切换, 2种防破音模式可选, 10W输出功率, 单通道音频功率放大器

封装图 (ESOP8)

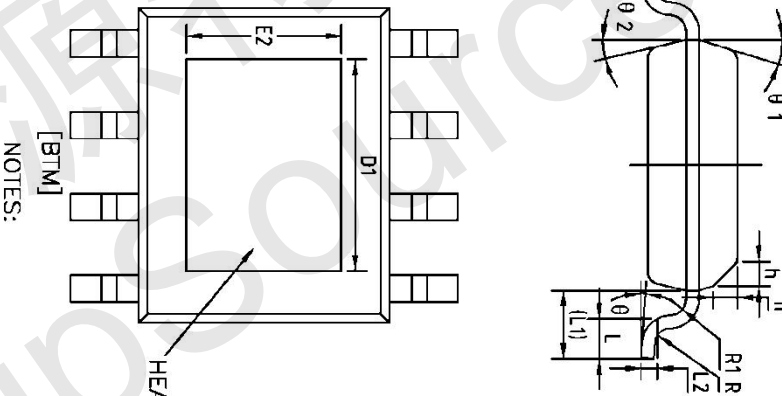
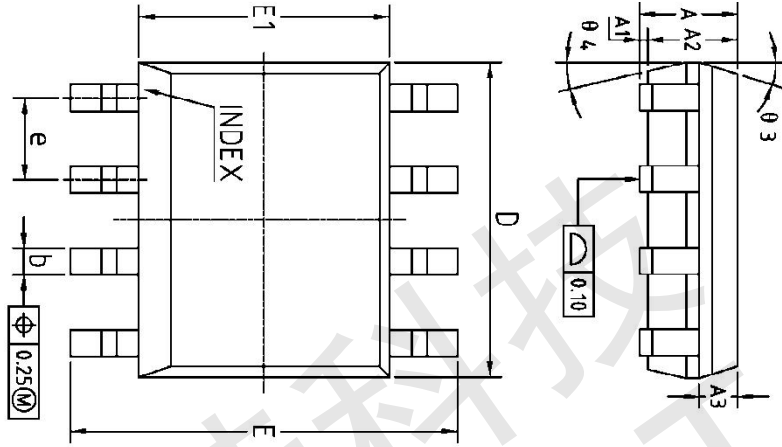

NOTES:
ALL DIMENSIONS REFER TO JEDEC STANDARD MS-012 AA
DO NOT INCLUDE MOLD FLASH OR PROTRUSIONS.

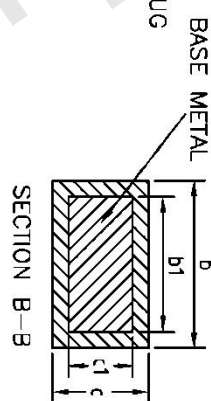

COMMON DIMENSIONS
(UNITS OF MEASURE=MILLIMETER)

SYMBOL	MIN	NOM	MAX
A	1.35	1.55	1.75
A1	0	0.10	0.15
A2	1.25	1.40	1.65
A3	0.50	0.60	0.70
b	0.38	-	0.51
b1	0.37	0.42	0.47
c	0.17	0.20	0.25
c1	0.17	0.20	0.23
D	4.80	4.90	5.00
D1	3.10	3.50	3.50
E	5.80	6.00	6.20
E1	3.80	3.90	4.00
E2	2.20	2.40	2.60
e	1.27/BSG	-	-
e	0.45	0.60	0.80
L1	1.04REF	-	-
L2	0.25BSC	-	-
R	0.07	-	-
R1	0.07	-	-
h	0.30	0.40	0.50
h	0	-	8°
h	0.1	15°	17°
h	0.2	11°	15°
h	0.3	15°	17°
h	0.4	11°	15°