

## Data Sheet

# HAL<sup>®</sup> 573...HAL 576, 579 HAL 581...HAL 584

Two-Wire Hall-Effect Sensor Family

---

**Copyright, Warranty, and Limitation of Liability**

The information and data contained in this document are believed to be accurate and reliable. The software and proprietary information contained therein may be protected by copyright, patent, trademark and/or other intellectual property rights of Micronas. All rights not expressly granted remain reserved by Micronas.

Micronas assumes no liability for errors and gives no warranty representation or guarantee regarding the suitability of its products for any particular purpose due to these specifications.

By this publication, Micronas does not assume responsibility for patent infringements or other rights of third parties which may result from its use. Commercial conditions, product availability and delivery are exclusively subject to the respective order confirmation.

Any information and data which may be provided in the document can and do vary in different applications, and actual performance may vary over time.

All operating parameters must be validated for each customer application by customers' technical experts. Any new issue of this document invalidates previous issues. Micronas reserves the right to review this document and to make changes to the document's content at any time without obligation to notify any person or entity of such revision or changes. For further advice please contact us directly.

Do not use our products in life-supporting systems, aviation and aerospace applications! Unless explicitly agreed to otherwise in writing between the parties, Micronas' products are not designed, intended or authorized for use as components in systems intended for surgical implants into the body, or other applications intended to support or sustain life, or for any other application in which the failure of the product could create a situation where personal injury or death could occur.

No part of this publication may be reproduced, photocopied, stored on a retrieval system or transmitted without the express written consent of Micronas.

**Micronas Trademarks**

– HAL

**Micronas Patents**

Choppered Offset Compensation protected by Micronas patents no. US5260614, US5406202, EP0525235 and EP0548391.

**Third-Party Trademarks**

All other brand and product names or company names may be trademarks of their respective companies.

---

**Contents**

<b>Page</b>	<b>Section</b>	<b>Title</b>
<b>4</b>	<b>1.</b>	<b>Introduction</b>
4	1.1.	Features
4	1.2.	Family Overview
5	1.3.	Marking Code
5	1.4.	Operating Junction Temperature Range (T <sub>J</sub> )
6	1.5.	Hall Sensor Package Codes
6	1.6.	Solderability and Welding
<b>7</b>	<b>2.</b>	<b>Functional Description</b>
<b>8</b>	<b>3.</b>	<b>Specifications</b>
8	3.1.	Outline Dimensions
13	3.2.	Dimensions of Sensitive Area
13	3.3.	Positions of Sensitive Areas
13	3.4.	Absolute Maximum Ratings
13	3.4.1.	Storage and Shelf Life
14	3.5.	Recommended Operating Conditions
15	3.6.	Characteristics
16	3.7.	Magnetic Characteristics Overview
<b>19</b>	<b>4.</b>	<b>Type Descriptions</b>
19	4.1.	HAL573
21	4.2.	HAL574
23	4.3.	HAL575
25	4.4.	HAL576
27	4.5.	HAL579
29	4.6.	HAL581
31	4.7.	HAL584
<b>33</b>	<b>5.</b>	<b>Application Notes</b>
33	5.1.	Application Circuit
33	5.2.	Extended Operating Conditions
33	5.3.	Start-Up Behavior
34	5.4.	Ambient Temperature
34	5.5.	EMC and ESD
<b>36</b>	<b>6.</b>	<b>Data Sheet History</b>

## Two-Wire Hall-Effect Sensor Family in CMOS technology

**Release Note: Revision bars indicate significant changes to the previous edition.**

### 1. Introduction

This sensor family consists of different two-wire Hall switches produced in CMOS technology. All sensors change the current consumption depending on the external magnetic field and require only two wires between sensor and evaluation circuit. The sensors of this family differ in the magnetic switching behavior and switching points.

The sensors include a temperature-compensated Hall plate with active offset compensation, a comparator, and a current source. The comparator compares the actual magnetic flux through the Hall plate (Hall voltage) with the fixed reference values (switching points). Accordingly, the current source is switched on (high current consumption) or off (low current consumption).

The active offset compensation leads to constant magnetic characteristics in the full supply voltage and temperature range. In addition, the magnetic parameters are robust against mechanical stress effects.

The sensors are designed for industrial and automotive applications and operate with supply voltages from 3.75 V to 24 V in the junction temperature range from -40 °C up to 140 °C. All sensors are available in the SMD package SOT89B-1 and in the leaded versions TO92UA-1 and TO92UA-2.

#### 1.1. Features

- current output for two-wire applications
- low current consumption: 5 mA...6.9 mA
- high current consumption: 12 mA...17 mA
- junction temperature range from -40 °C up to 140 °C.
- operates from 3.75 V to 24 V supply voltage
- operates with static magnetic fields and dynamic magnetic fields up to 10 kHz
- switching offset compensation at typically 145 kHz
- overvoltage and reverse-voltage protection
- magnetic characteristics are robust against mechanical stress effects
- constant magnetic switching points over a wide supply voltage range

- the decrease of magnetic flux density caused by rising temperature in the sensor system is compensated by a built-in negative temperature coefficient of the magnetic characteristics
- ideal sensor for applications in extreme automotive and industrial environments
- EMC corresponding to ISO 7637

### 1.2. Family Overview

Type	Switching Behavior	Sensitivity	see Page
573	unipolar	low	19
574	unipolar	medium	21
575	latching	medium	23
576	unipolar	medium	25
579	latching	medium	27
581	unipolar inverted	medium	29
584	unipolar inverted	medium	31

#### Unipolar Switching Sensors:

The sensor turns to high current consumption with the magnetic south pole on the branded side of the package and turns to low consumption if the magnetic field is removed. The sensor does not respond to the magnetic north pole on the branded side.

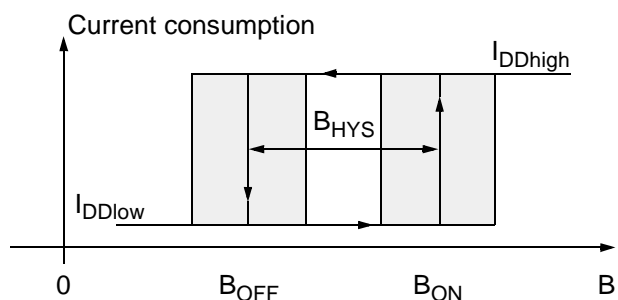
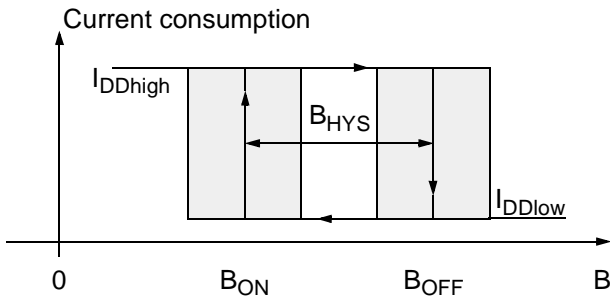


Fig. 1-1: Unipolar Switching Sensor

**Unipolar Inverted Switching Sensors:**

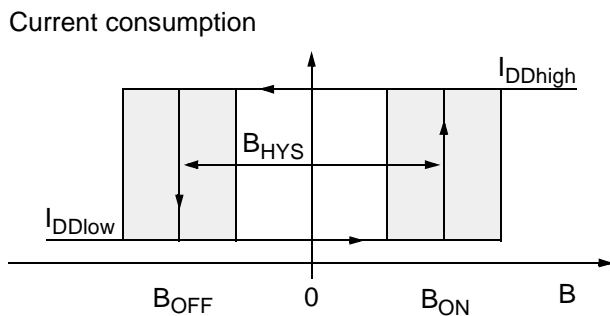
The sensor turns to low current consumption with the magnetic south pole on the branded side of the package and turns to high consumption if the magnetic field is removed. The sensor does not respond to the magnetic north pole on the branded side.



**Fig. 1–2:** Unipolar Inverted Switching Sensor

**Latching Sensor:**

The sensor turns to high current consumption with the magnetic south pole on the branded side of the package and turns to low consumption with the magnetic north pole on the branded side. The current consumption does not change if the magnetic field is removed. For changing the current consumption, the opposite magnetic field polarity must be applied.



**Fig. 1–3:** Latching Sensor

**1.3. Marking Code**

All Hall sensors have a marking on the package surface (branded side). This marking includes the name of the sensor and the temperature range.

Type	Temperature Range	
	K	E
HAL573	573K	573E
HAL574	574K	574E
HAL575	575K	575E
HAL576	576K	576E
HAL579	579K	579E
HAL581	581K	581E
HAL584	584K	584E

**1.4. Operating Junction Temperature Range (T<sub>J</sub>)**

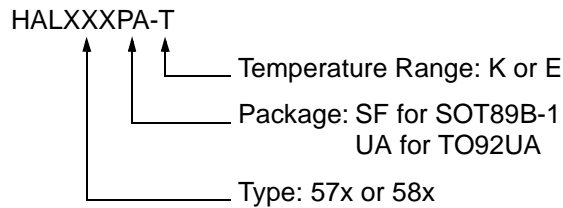
The Hall sensors from Micronas are specified to the chip temperature (junction temperature T<sub>J</sub>).

**K:** T<sub>J</sub> = -40 °C to +140 °C

**E:** T<sub>J</sub> = -40 °C to +100 °C

**Note:** Due to the high power dissipation at high current consumption, there is a difference between the ambient temperature (T<sub>A</sub>) and junction temperature. Please refer to Section 5.4. on page 34 for details.

## 1.5. Hall Sensor Package Codes



Example: **HAL581UA-E**

- Type: 581
- Package: TO92UA
- Temperature Range:  $T_J = -40\text{ °C to }+100\text{ °C}$

Hall sensors are available in a wide variety of packaging versions and quantities. For more detailed information, please refer to the brochure: “Hall Sensors: Ordering Codes, Packaging, Handling”.

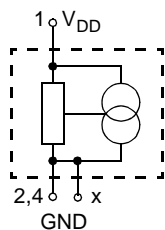
## 1.6. Solderability and Welding

### Solderability

During soldering reflow processing and manual reworking, a component body temperature of 260 °C should not be exceeded.

### Welding

Device terminals should be compatible with laser and resistance welding. Please note that the success of the welding process is subject to different welding parameters which will vary according to the welding technique used. A very close control of the welding parameters is absolutely necessary in order to reach satisfying results. Micronas, therefore, does not give any implied or express warranty as to the ability to weld the component.



x = pin 3 for TO92UA-1/-2 package  
 x = pin 4 for SOT89B-1 package

**Fig. 1–4:** Pin configuration

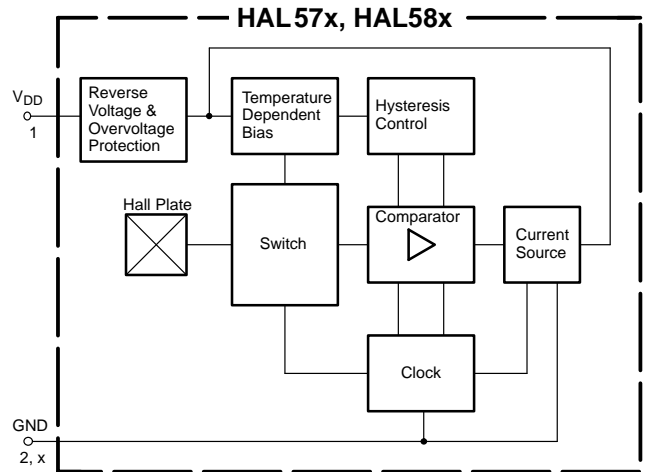
**2. Functional Description**

The HAL57x, HAL58x two-wire sensors are monolithic integrated circuits which switch in response to magnetic fields. If a magnetic field with flux lines perpendicular to the sensitive area is applied to the sensor, the biased Hall plate forces a Hall voltage proportional to this field. The Hall voltage is compared with the actual threshold level in the comparator. The temperature-dependent bias increases the supply voltage of the Hall plates and adjusts the switching points to the decreasing induction of magnets at higher temperatures.

If the magnetic field exceeds the threshold levels, the current source switches to the corresponding state. In the low current consumption state, the current source is switched off and the current consumption is caused only by the current through the Hall sensor. In the high current consumption state, the current source is switched on and the current consumption is caused by the current through the Hall sensor and the current source. The built-in hysteresis eliminates oscillation and provides switching behavior of the output signal without bouncing.

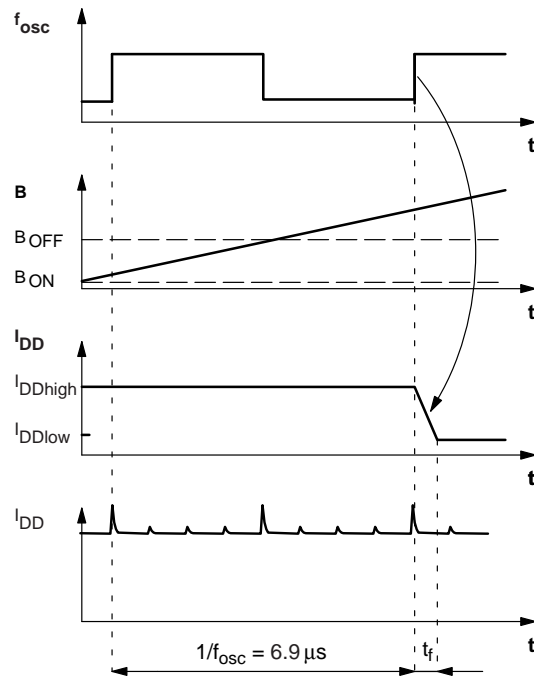
Magnetic offset caused by mechanical stress is compensated for by using the "switching offset compensation technique". An internal oscillator provides a two-phase clock. In each phase, the current is forced through the Hall plate in a different direction, and the Hall voltage is measured. At the end of the two phases, the Hall voltages are averaged and thereby the offset voltages are eliminated. The average value is compared with the fixed switching points. Subsequently, the current consumption switches to the corresponding state. The amount of time elapsed from crossing the magnetic switching level to switching of the current level can vary between zero and  $1/f_{osc}$ .

Shunt protection devices clamp voltage peaks at the  $V_{DD}$ -pin together with external series resistors. Reverse current is limited at the  $V_{DD}$ -pin by an internal series resistor up to  $-15$  V. No external protection diode is needed for reverse voltages ranging from  $0$  V to  $-15$  V.



x = pin 3 for TO92UA-1/-2 package  
 x = pin 4 for SOT89B-1 package

**Fig. 2-1:** HAL57x, HAL58x block diagram



**Fig. 2-2:** Timing diagram (example: HAL581)

3. Specifications

3.1. Outline Dimensions

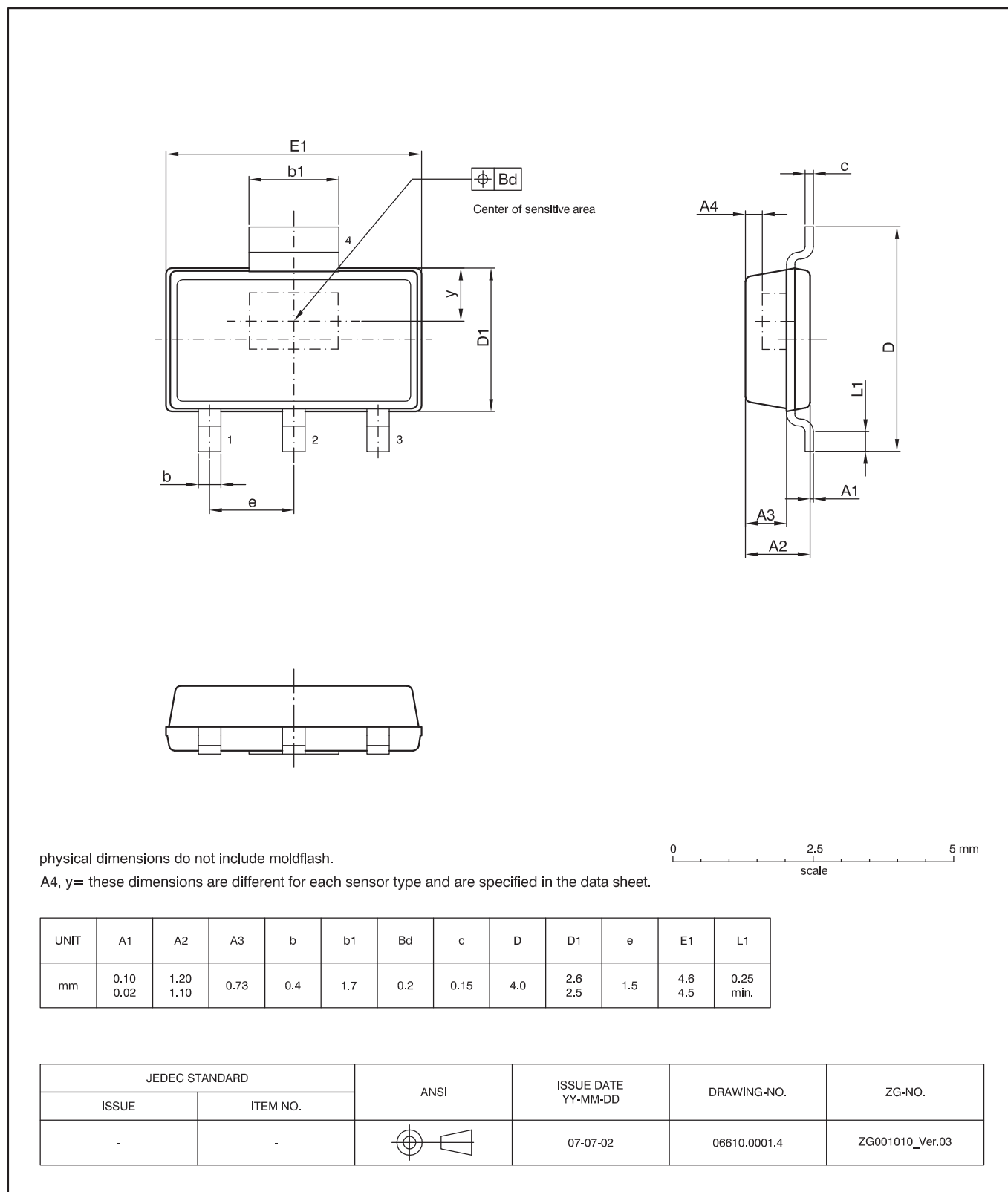
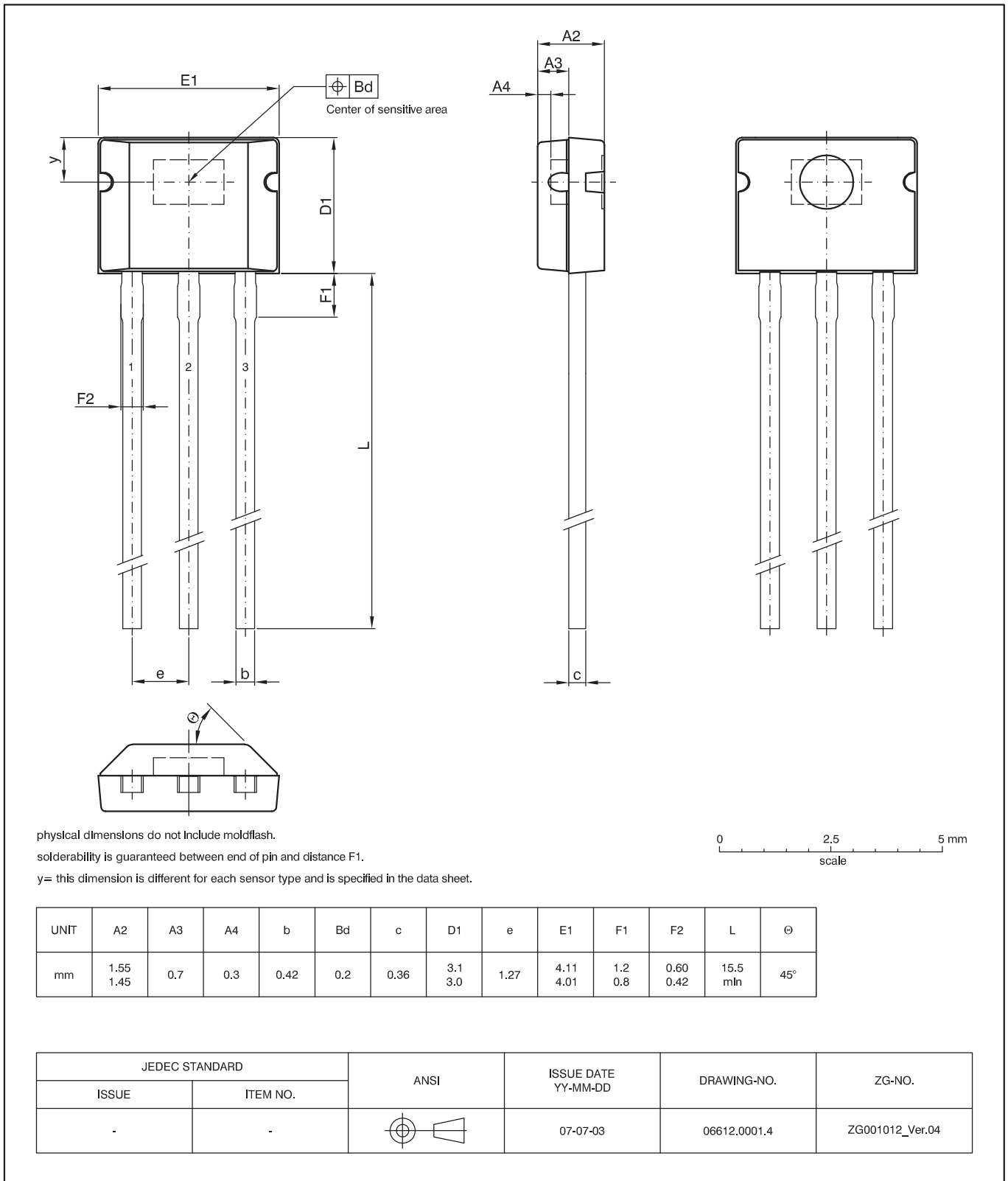
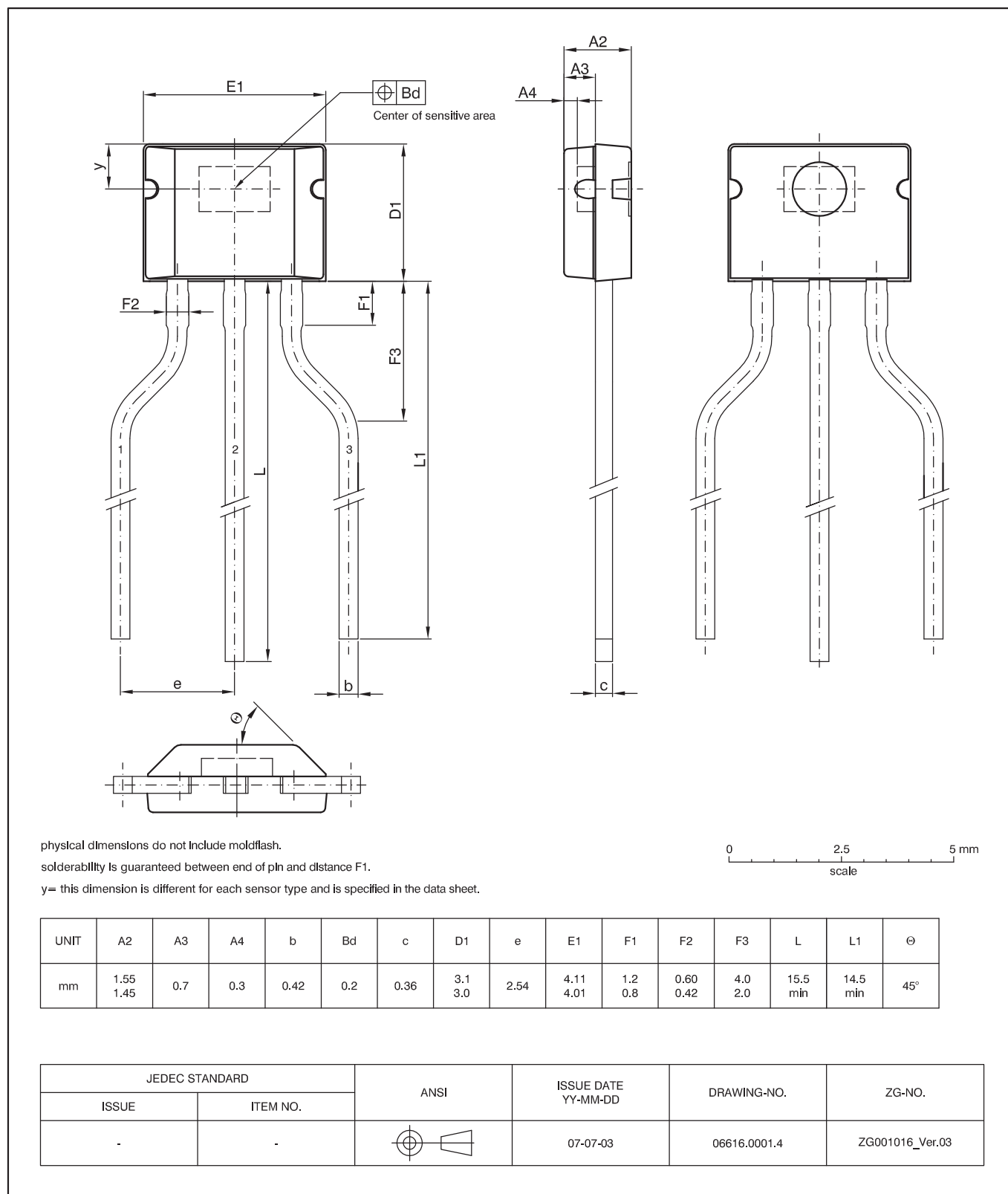


Fig. 3-1:  
**SOT89B-1: Plastic Small Outline Transistor package, 4 leads**  
 Weight approximately 0.034 g

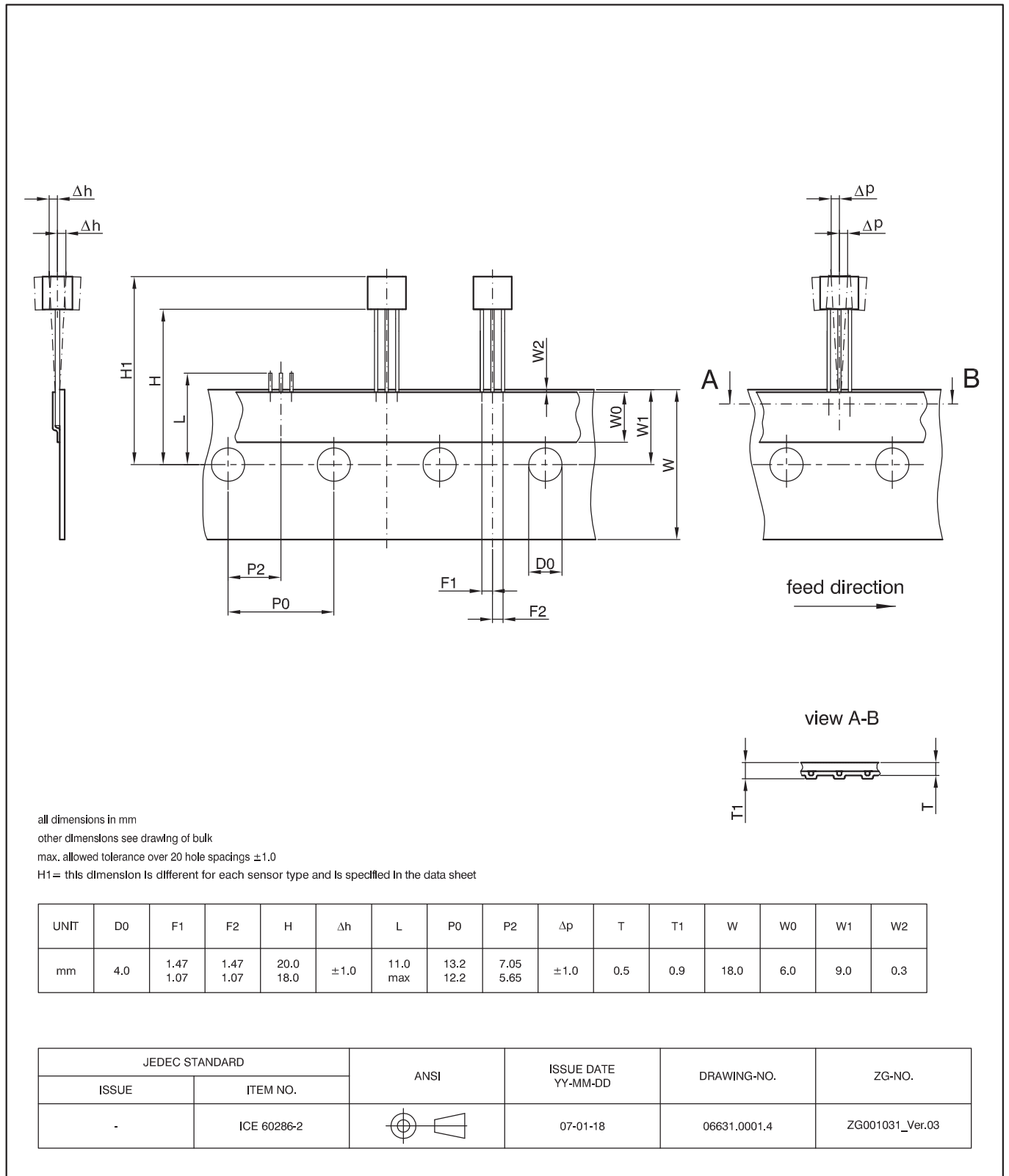




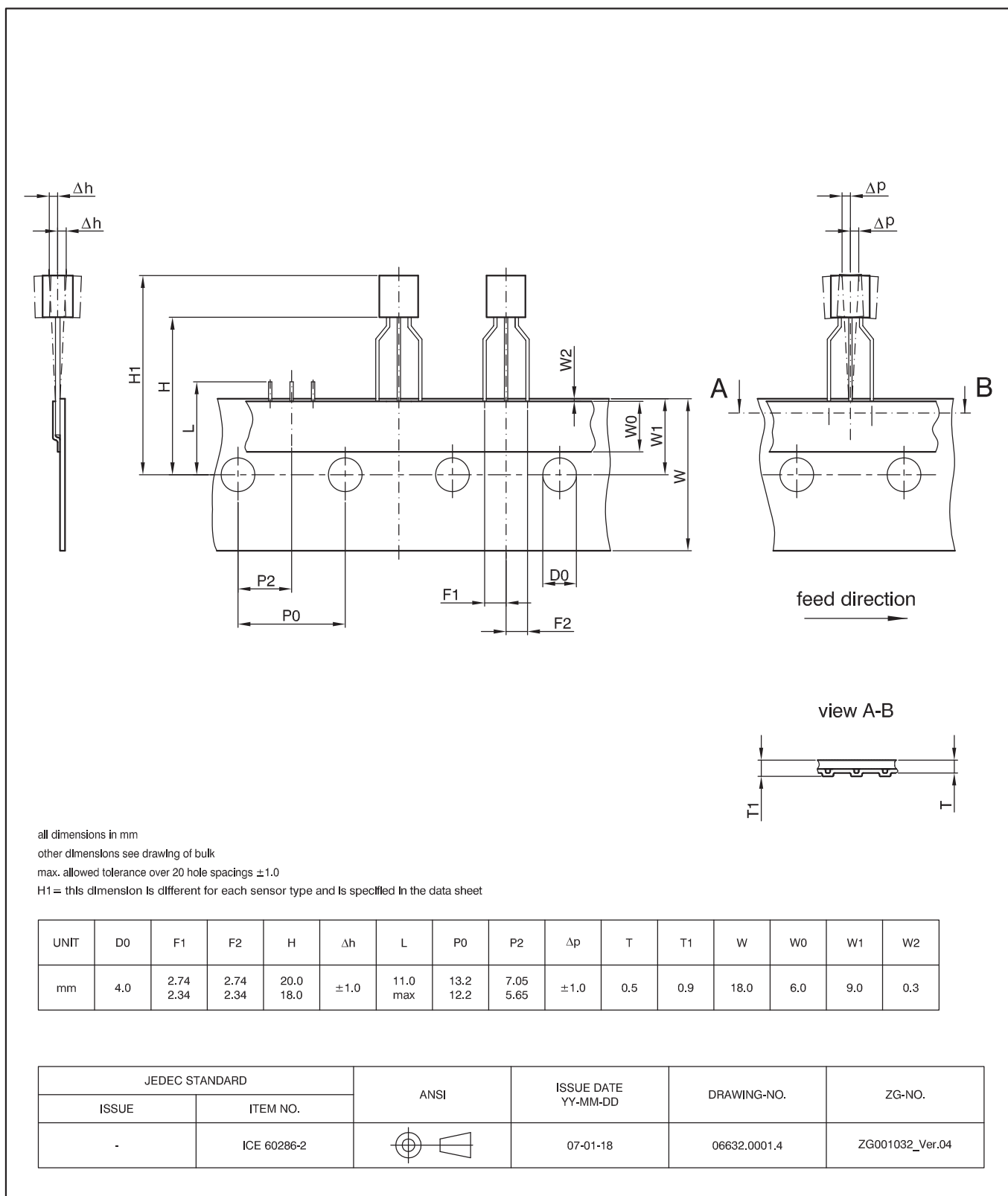
**Fig. 3-2:**  
**TO92UA-2:** Plastic Transistor Standard UA package, 3 leads, not spread  
 Weight approximately 0.106 g



**Fig. 3-3:**  
**TO92UA-1:** Plastic Transistor Standard UA package, 3 leads, spread  
 Weight approximately 0.106 g



**Fig. 3-4:**  
**TO92UA-2: Dimensions ammpack inline, not spread**



**Fig. 3-5:**  
**T092UA-1: Dimensions ammpack inline, spread**

### 3.2. Dimensions of Sensitive Area

0.25 mm x 0.12 mm

### 3.3. Positions of Sensitive Areas

	SOT89B-1	TO92UA-1/-2
y	0.85 mm nominal	0.9 mm nominal
A4	0.3 mm nominal	

### 3.4. Absolute Maximum Ratings

Stresses beyond those listed in the "Absolute Maximum Ratings" may cause permanent damage to the device. This is a stress rating only. Functional operation of the device at these conditions is not implied. Exposure to absolute maximum rating conditions for extended periods will affect device reliability.

This device contains circuitry to protect the inputs and outputs against damage due to high static voltages or electric fields; however, it is advised that normal precautions be taken to avoid application of any voltage higher than absolute maximum-rated voltages to this circuit.

All voltages listed are referenced to ground (GND).

Symbol	Parameter	Pin Name	Min.	Max.	Unit
V <sub>DD</sub>	Supply Voltage	1	-15 <sup>1)2)</sup>	28 <sup>2)</sup>	V
T <sub>J</sub>	Junction Temperature Range		-40	170	°C
<sup>1)</sup> -18 V with a 100 Ω series resistor at pin 1 (-16 V with a 30 Ω series resistor) <sup>2)</sup> as long as T <sub>Jmax</sub> is not exceeded					

#### 3.4.1. Storage and Shelf Life

The permissible storage time (shelf life) of the sensors is unlimited, provided the sensors are stored at a maximum of 30 °C and a maximum of 85% relative humidity. At these conditions, no Dry Pack is required.

Solderability is guaranteed for one year from the date code on the package.

### 3.5. Recommended Operating Conditions

Functional operation of the device beyond those indicated in the “Recommended Operating Conditions/Characteristics” is not implied and may result in unpredictable behavior, reduce reliability and lifetime of the device.

All voltages listed are referenced to ground (GND).

Symbol	Parameter	Pin No.	Min.	Typ.	Max.	Unit
$V_{DD}$	Supply Voltage	1	3.75		24	V
$T_A$	Ambient Temperature for Continuous Operation		-40		85 <sup>1)</sup>	°C
$t_{on}$	Supply Time for Pulsed Mode		-	30	-	μs
<sup>1)</sup> when using the “K” type and $V_{DD} \leq 16$ V						

**Note:** Due to the high power dissipation at high current consumption, there is a difference between the ambient temperature ( $T_A$ ) and junction temperature. The power dissipation can be reduced by repeatedly switching the supply voltage on and off (pulse mode). Please refer to Section 5.4. on page 34 for details.

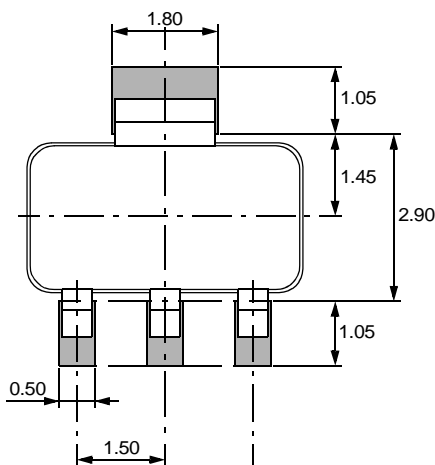
**3.6. Characteristics**

at  $T_J = -40\text{ }^\circ\text{C}$  to  $+140\text{ }^\circ\text{C}$ ,  $V_{DD} = 3.75\text{ V}$  to  $24\text{ V}$

at Recommended Operation Conditions if not otherwise specified in the column "Conditions".

Typical Characteristics for  $T_J = 25\text{ }^\circ\text{C}$  and  $V_{DD} = 12\text{ V}$ .

Symbol	Parameter	Pin No.	Min.	Typ.	Max.	Unit	Test Conditions
$I_{DDlow}$	Low Current Consumption over Temperature Range	1	5	6	6.9	mA	
			4.5	6	6.9	mA	for HAL579 only
$I_{DDhigh}$	High Current Consumption over Temperature Range	1	12	14.3	17	mA	
$V_{DDZ}$	Overshoot Protection at Supply	1	–	28.5	32	V	$I_{DD} = 25\text{ mA}$ , $T_J = 25\text{ }^\circ\text{C}$ , $t = 20\text{ ms}$
$f_{osc}$	Internal Oscillator Chopper Frequency over Temperature Range	–	–	145	–	kHz	
$t_{en(O)}$	Enable Time of Output after Setting of $V_{DD}$	1	–	30	–	$\mu\text{s}$	1)
$t_r$	Output Rise Time	1	–	0.4	1.6	$\mu\text{s}$	$V_{DD} = 12\text{ V}$ , $R_S = 30\ \Omega$
$t_f$	Output Fall Time	1	–	0.4	1.6	$\mu\text{s}$	$V_{DD} = 12\text{ V}$ , $R_S = 30\ \Omega$
<b>SOT89B Package</b>							
$R_{thja}$	Thermal Resistance Junction to Ambient	–	–	–	209 <sup>2)</sup>	K/W	30 mm x 10 mm x 1.5 mm, pad size (see Fig. 3–6)
$R_{thjc}$	Junction to Case	–	–	–	56 <sup>2)</sup>	K/W	
$R_{thjs}$	Junction to Solder Point	–	–	–	82 <sup>3)</sup>	K/W	
<b>TO92UA Package</b>							
$R_{thja}$	Thermal Resistance Junction to Ambient	–	–	–	246 <sup>2)</sup>	K/W	
$R_{thjc}$	Junction to Case	–	–	–	70 <sup>2)</sup>	K/W	
$R_{thjs}$	Junction to Solder Point	–	–	–	127 <sup>3)</sup>	K/W	
1) $B > B_{ON} + 2\text{ mT}$ or $B < B_{OFF} - 2\text{ mT}$ for HAL57x, $B > B_{OFF} + 2\text{ mT}$ or $B < B_{ON} - 2\text{ mT}$ for HAL58x 2) Measured with a 1s0p board 3) Measured with a 1s1p board							



**Fig. 3–6:** Recommend pad size SOT89B-1  
Dimensions in mm

### 3.7. Magnetic Characteristics Overview

at  $T_J = -40\text{ °C}$  to  $+140\text{ °C}$ ,  $V_{DD} = 3.75\text{ V}$  to  $24\text{ V}$ ,  
 Typical Characteristics for  $T_J = 25\text{ °C}$  and  $V_{DD} = 12\text{ V}$ .

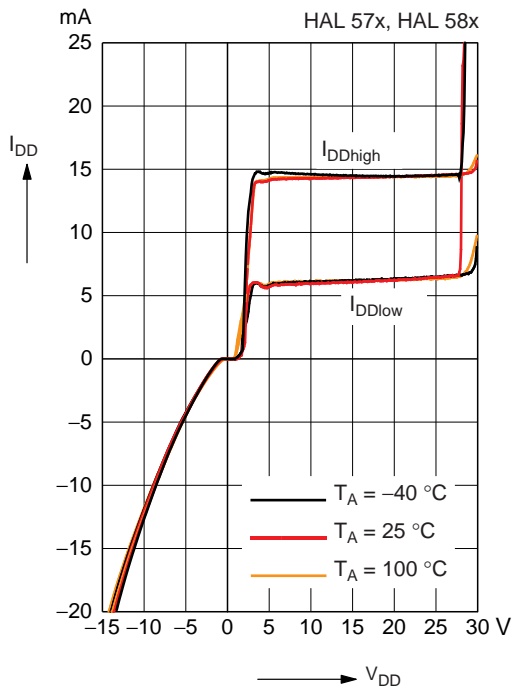
Magnetic flux density values of switching points.

Positive flux density values refer to the magnetic south pole at the branded side of the package.

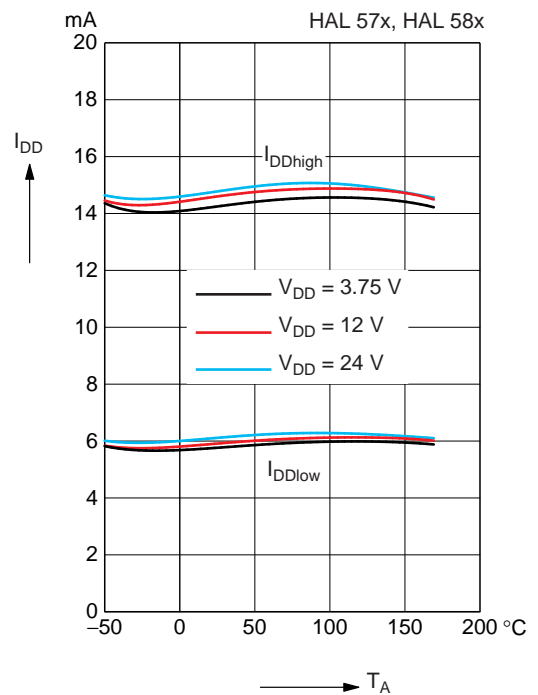
Sensor Switching Type	Parameter $T_J$	On point $B_{ON}$			Off point $B_{OFF}$			Hysteresis $B_{HYS}$			Unit
		Min.	Typ.	Max.	Min.	Typ.	Max.	Min.	Typ.	Max.	
HAL573 unipolar	-40 °C	37	44.2	49	34	42	48	0.5	2.2	5	mT
	25 °C	37	43.5	49	34	41.5	47	0.5	2	5	mT
	100 °C	34	40	46	32	38	44	0.5	2	5	mT
	140 °C	34	38	46	32	36	44	0.2	2	5	mT
HAL574 unipolar	-40 °C	5.5	9.2	12	5	7.2	11.5	0.5	2	3	mT
	25 °C	5.5	9.2	12	5	7.2	11.5	0.5	2	3	mT
	100 °C	5.5	9.2	12	5	7.2	11.5	0.5	2	3	mT
	140 °C	5	8.8	12.5	3.5	7.5	11.5	0.2	1.9	3.5	mT
HAL575 latching	-40 °C	0.5	4	8	-8	-4	-0.5	5	8	11	mT
	25 °C	0.5	4	8	-8	-4	-0.5	5	8	11	mT
	100 °C	0.5	4	8	-8	-4	-0.5	5	8	11	mT
	140 °C	0.5	4	8	-8	-4	-0.5	5	8	11	mT
HAL576 unipolar	-40 °C	3.3	5.7	8.2	1.8	4.2	6.7	0.3	1.9	3.5	mT
	25 °C	3.3	5.7	8.2	1.8	4.2	6.7	0.3	1.9	3.5	mT
	100 °C	2.8	5.5	8.3	1.3	4	6.8	0.3	1.9	3.5	mT
	140 °C	2	5.2	8.3	0.3	3.7	7	0.3	1.9	3.5	mT
HAL579 latching	-40 °C	5.5	12.0	18.5	-18.5	-12.0	-5.5	16.0	22.0	28.0	mT
	25 °C	5.5	12.0	18.5	-18.5	-12.0	-5.5	16.0	22.0	28.0	mT
	100 °C	5.5	12.0	18.5	-18.5	-12.0	-5.5	16.0	22.0	28.0	mT
	140 °C	5.5	12.0	18.5	-18.5	-12.0	-5.5	16.0	22.0	28.0	mT
HAL581 unipolar inverted	-40 °C	6.5	10	13.8	8	12	15.5	0.5	2	3.5	mT
	25 °C	6.5	10	13.8	8	12	15.5	0.5	2	3.5	mT
	100 °C	6.5	10	13.8	8	12	15.5	0.5	2	3.5	mT
	140 °C	6.5	10.4	14.3	8	12	16	0.5	2	3.5	mT
HAL584 unipolar inverted	-40 °C	5	7.2	11.5	5.5	9.2	12	0.5	2	3.0	mT
	25 °C	5	7.2	11.5	5.5	9.2	12	0.5	2	3.0	mT
	100 °C	5	7.2	11.5	5.5	9.2	12	0.5	2	3.0	mT
	140 °C	4.5	8	11.5	5.5	9	12.5	0.2	1.9	3.5	mT

**Note:** For detailed descriptions of the individual types, see pages 19 and following.

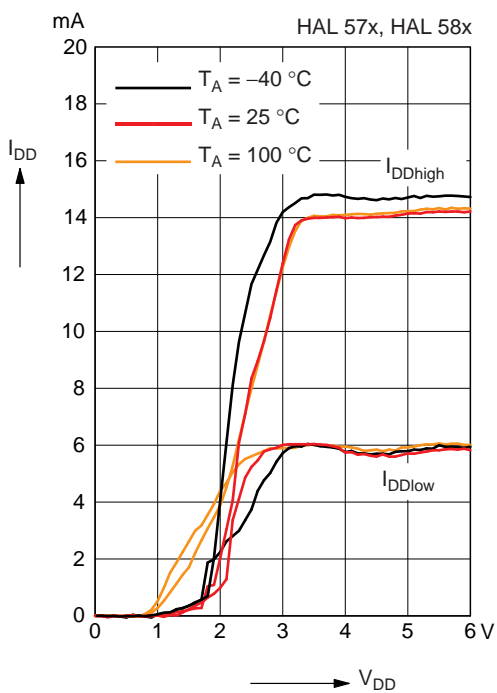




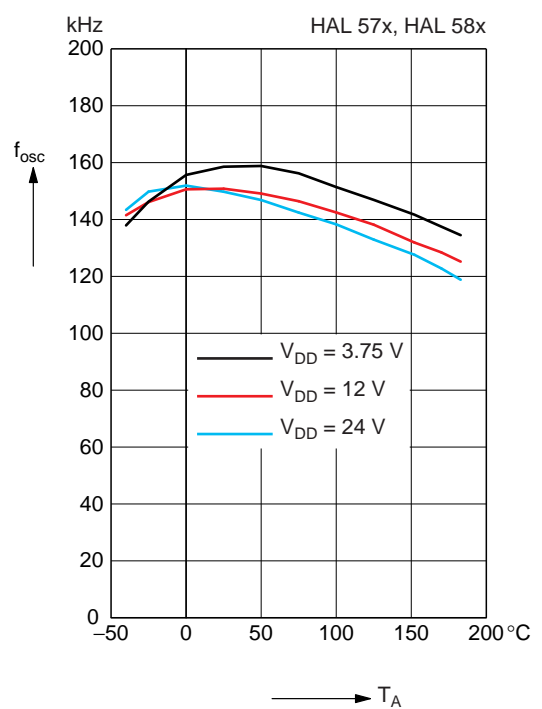
**Fig. 3-7:** Typical supply current versus supply voltage



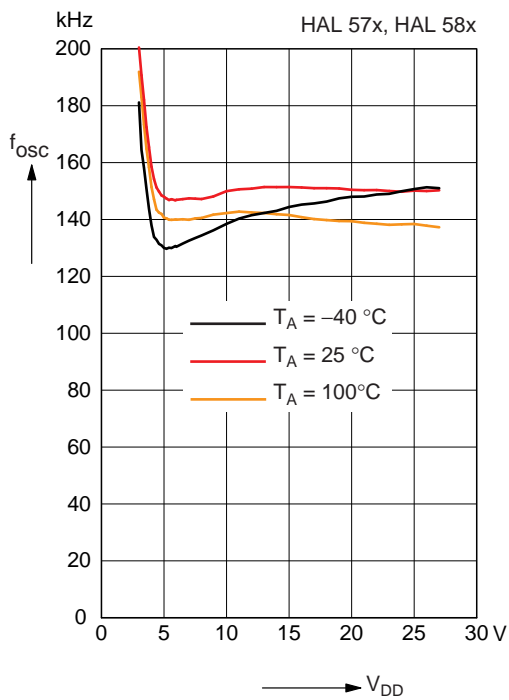
**Fig. 3-9:** Typical current consumption versus ambient temperature



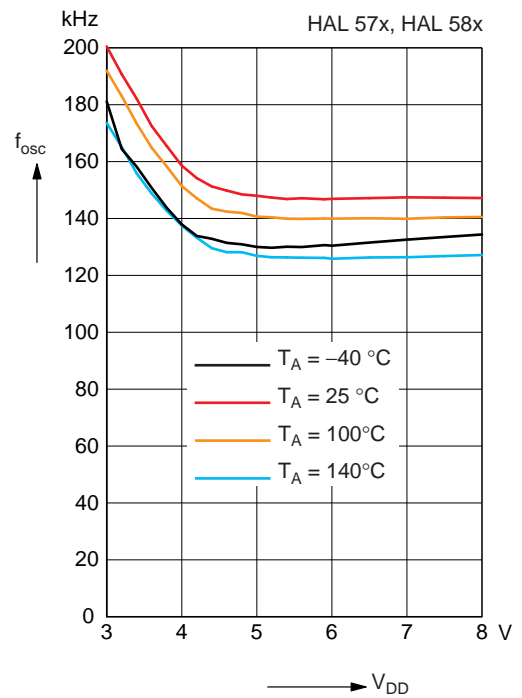
**Fig. 3-8:** Typical supply current versus supply voltage



**Fig. 3-10:** Typ. internal chopper frequency versus ambient temperature



**Fig. 3-11:** Typ. internal chopper frequency versus supply voltage



**Fig. 3-12:** Typ. internal chopper frequency versus supply voltage

**4. Type Descriptions**

**4.1. HAL573**

The HAL573 is a unipolar switching sensor with low sensitivity (see Fig. 4–1).

The sensor turns to high current consumption with the magnetic south pole on the branded side of the package and turns to low current consumption if the magnetic field is removed. It does not respond to the magnetic north pole on the branded side.

For correct functioning in the application, the sensor requires only the magnetic south pole on the branded side of the package.

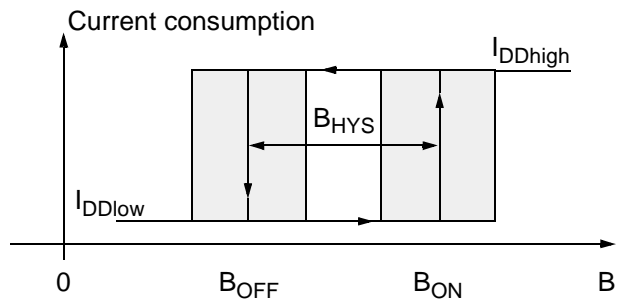
**Magnetic Features:**

- switching type: unipolar
- low sensitivity
- typical  $B_{ON}$ : 43.5 mT at room temperature
- typical  $B_{OFF}$ : 41.5 mT at room temperature
- typical temperature coefficient of magnetic switching points is  $-1100$  ppm/K
- operates with static magnetic fields and dynamic magnetic fields up to 10 kHz

**Applications**

The HAL573 is designed for applications with one magnetic polarity and weak magnetic amplitudes at the sensor position such as:

- solid state switches,
- contactless solutions to replace micro switches,
- position and end point detection, and
- rotating speed measurement.



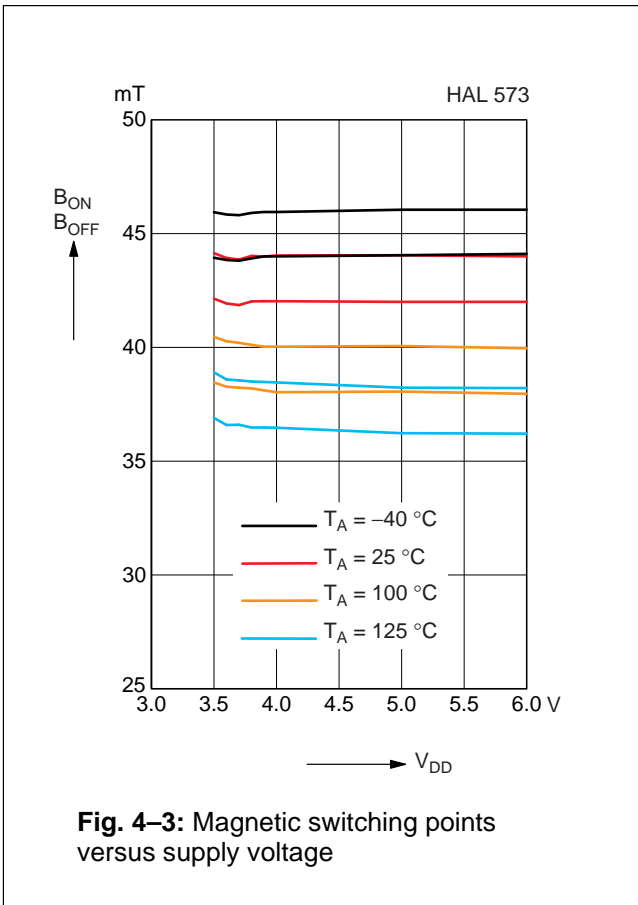
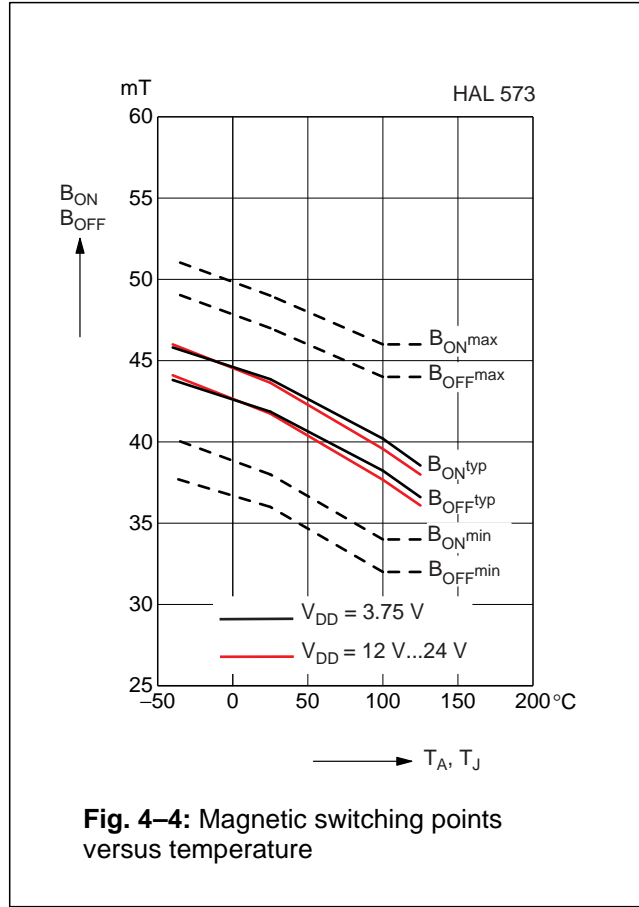
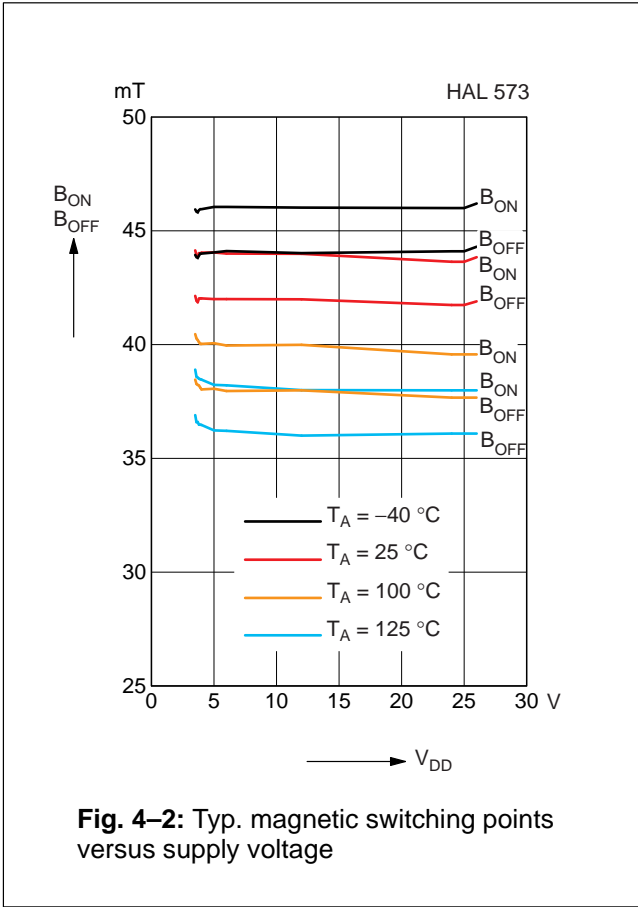
**Fig. 4–1:** Definition of magnetic switching points for the HAL573

**Magnetic Characteristics** at  $T_J = -40$  °C° to  $+140$  °C,  $V_{DD} = 3.75$  V to 24 V, Typical Characteristics for  $V_{DD} = 12$  V

Magnetic flux density values of switching points. Positive flux density values refer to the magnetic south pole at the branded side of the package.

Parameter	On point $B_{ON}$			Off point $B_{OFF}$			Hysteresis $B_{HYS}$			Magnetic Offset			Unit
	Min.	Typ.	Max.	Min.	Typ.	Max.	Min.	Typ.	Max.	Min.	Typ.	Max.	
$T_J$ -40 °C	37	44.2	49	34	42	48	0.5	2.2	5		44.6		mT
25 °C	37	43.5	49	34	41.5	47	0.5	2	5		42.5		mT
100 °C	34	40	46	32	38	44	0.5	2	5		39		mT
140 °C	34	38	46	32	36	44	0.2	2	5		39		mT

The hysteresis is the difference between the switching points  $B_{HYS} = B_{ON} - B_{OFF}$   
 The magnetic offset is the mean value of the switching points  $B_{OFFSET} = (B_{ON} + B_{OFF}) / 2$



**Note:** In the diagram “Magnetic switching points versus temperature” the curves for  $B_{ONmin}$ ,  $B_{ONmax}$ ,  $B_{OFFmin}$ , and  $B_{OFFmax}$  refer to junction temperature, whereas typical curves refer to ambient temperature.

**4.2. HAL574**

The HAL574 is a medium sensitive unipolar switching sensor (see Fig. 4–5).

The sensor turns to high current consumption with the magnetic south pole on the branded side of the package and turns to low current consumption if the magnetic field is removed. It does not respond to the magnetic north pole on the branded side.

For correct functioning in the application, the sensor requires only the magnetic south pole on the branded side of the package.

In this two-wire sensor family, the HAL584 is a sensor with the same magnetic characteristics but with an inverted output characteristic.

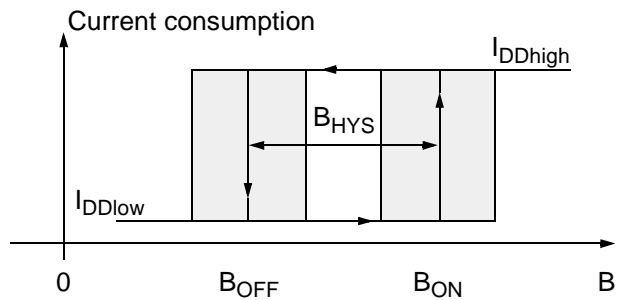
**Magnetic Features:**

- switching type: unipolar
- medium sensitivity
- typical  $B_{ON}$ : 9.2 mT at room temperature
- typical  $B_{OFF}$ : 7.2 mT at room temperature
- typical temperature coefficient of magnetic switching points is 0 ppm/K
- operates with static magnetic fields and dynamic magnetic fields up to 10 kHz

**Applications**

The HAL574 is designed for applications with one magnetic polarity and weak magnetic amplitudes at the sensor position such as:

- applications with large airgap or weak magnets,
- solid state switches,
- contactless solutions to replace micro switches,
- position and end point detection, and
- rotating speed measurement.



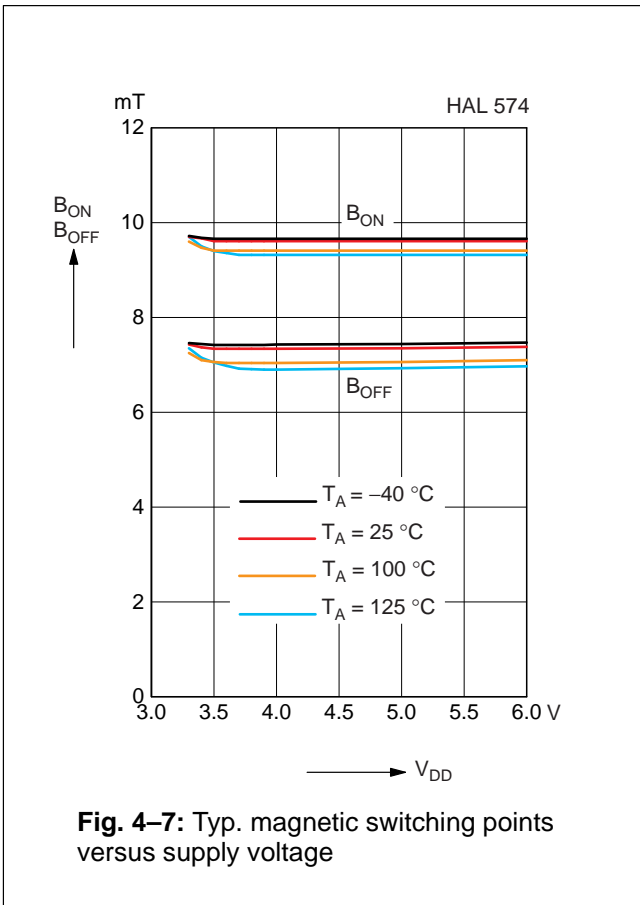
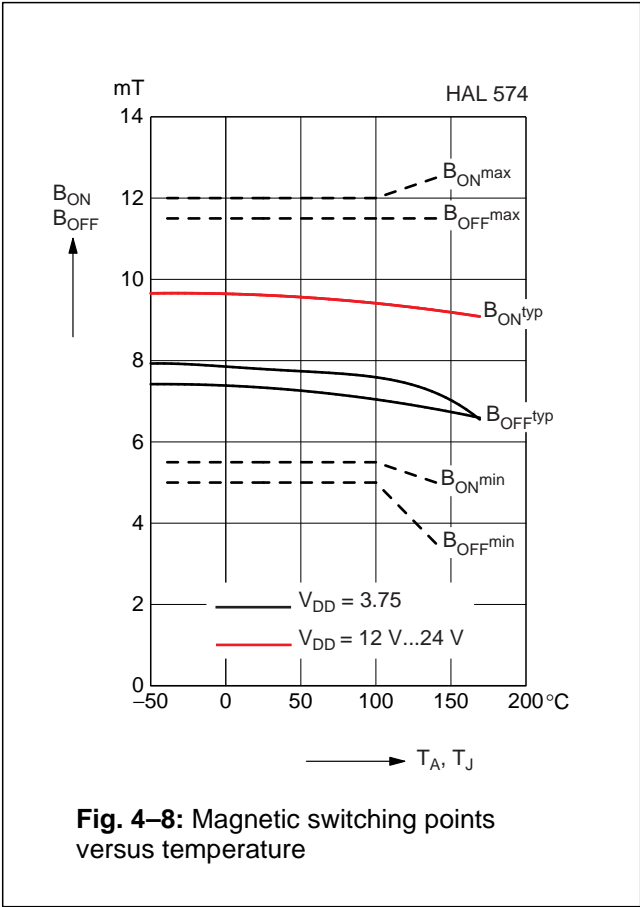
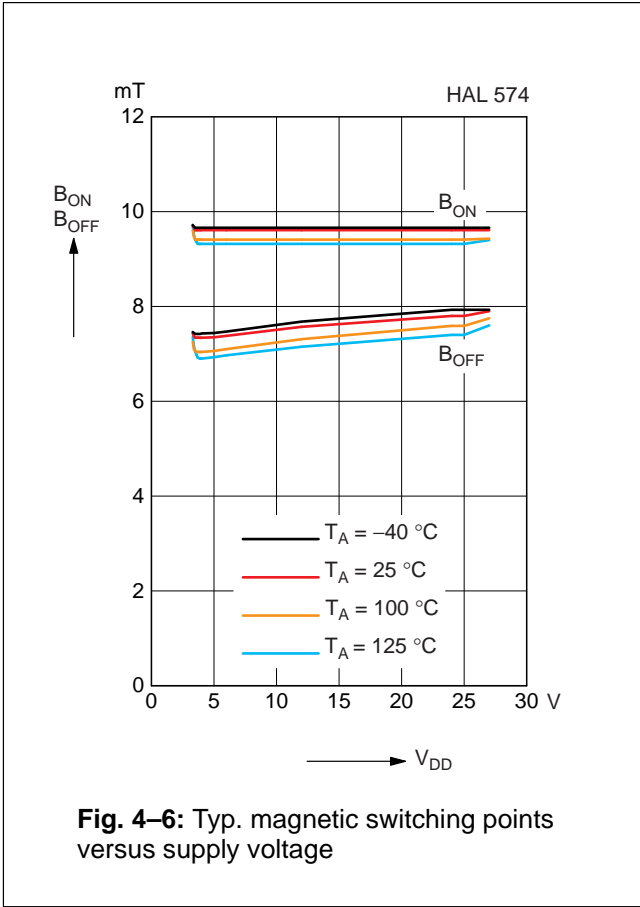
**Fig. 4–5:** Definition of magnetic switching points for the HAL574

**Magnetic Characteristics** at  $T_J = -40\text{ °C}$  to  $+140\text{ °C}$ ,  $V_{DD} = 4.3\text{ V}$  to  $24\text{ V}$ , Typical Characteristics for  $V_{DD} = 12\text{ V}$

Magnetic flux density values of switching points. Positive flux density values refer to the magnetic south pole at the branded side of the package.

Parameter $T_J$	On point $B_{ON}$			Off point $B_{OFF}$			Hysteresis $B_{HYS}$			Magnetic Offset			Unit
	Min.	Typ.	Max.	Min.	Typ.	Max.	Min.	Typ.	Max.	Min.	Typ.	Max.	
-40 °C	5.5	9.2	12	5	7.2	11.5	0.5	2	3		8.2		mT
25 °C	5.5	9.2	12	5	7.2	11.5	0.5	2	3		8.2		mT
100 °C	5.5	9.2	12	5	7.2	11.5	0.5	2	3		8.2		mT
140 °C	5	8.8	12.5	3.5	7.5	11.5	0.2	1.9	3.5		8.2		mT

The hysteresis is the difference between the switching points  $B_{HYS} = B_{ON} - B_{OFF}$   
 The magnetic offset is the mean value of the switching points  $B_{OFFSET} = (B_{ON} + B_{OFF}) / 2$



**Note:** In the diagram “Magnetic switching points versus temperature”, the curves for  $B_{ONmin}$ ,  $B_{ONmax}$ ,  $B_{OFFmin}$ , and  $B_{OFFmax}$  refer to junction temperature, whereas typical curves refer to ambient temperature.

**4.3. HAL575**

The HAL575 is a medium sensitive latching switching sensor (see Fig. 4–9).

The sensor turns to high current consumption with the magnetic south pole on the branded side of the package and turns to low consumption with the magnetic north pole on the branded side. The current consumption does not change if the magnetic field is removed. For changing the current consumption, the opposite magnetic field polarity must be applied.

For correct functioning in the application, the sensor requires both magnetic polarities on the branded side of the package.

**Magnetic Features:**

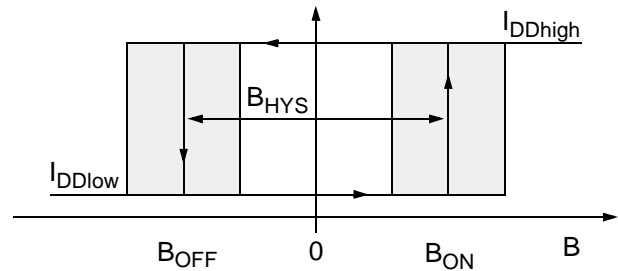
- switching type: latching
- medium sensitivity
- typical  $B_{ON}$ : 4 mT at room temperature
- typical  $B_{OFF}$ : -4 mT at room temperature
- typical temperature coefficient of magnetic switching points is 0 ppm/K
- operates with static magnetic fields and dynamic magnetic fields up to 10 kHz

**Applications**

The HAL575 is designed for applications with both magnetic polarities and weak magnetic amplitudes at the sensor position such as:

- applications with large airgap or weak magnets,
- multipole magnet applications,
- contactless solutions to replace micro switches,
- rotating speed measurement.

Current consumption



**Fig. 4–9:** Definition of magnetic switching points for the HAL575

**Magnetic Characteristics** at  $T_J = -40\text{ °C}$  to  $+140\text{ °C}$ ,  $V_{DD} = 3.75\text{ V}$  to  $24\text{ V}$ , Typical Characteristics for  $V_{DD} = 12\text{ V}$

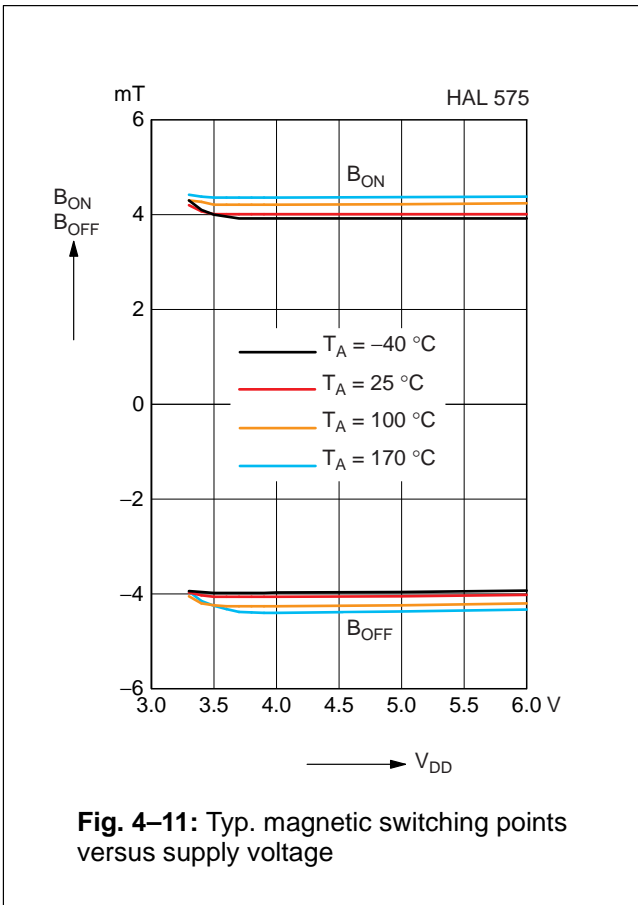
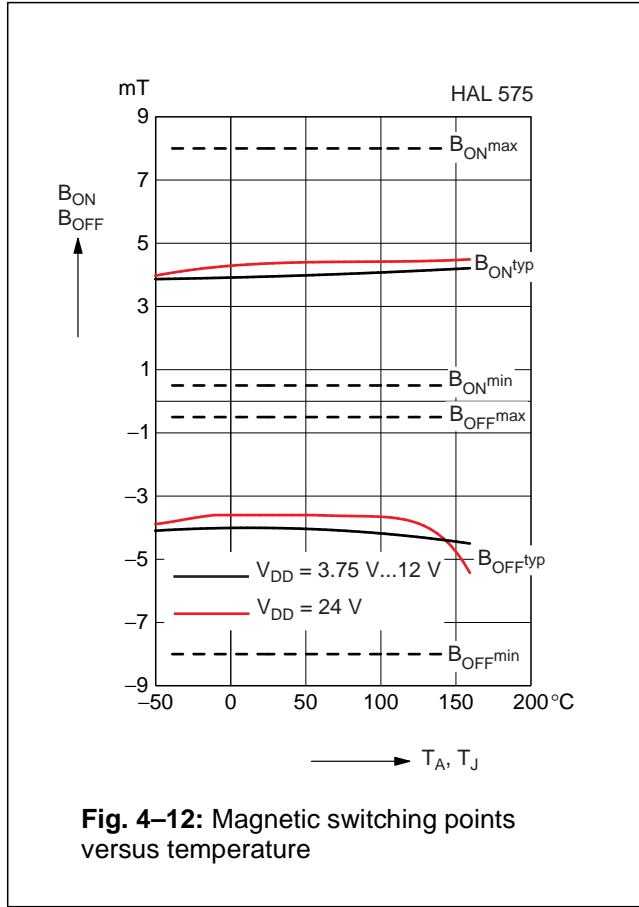
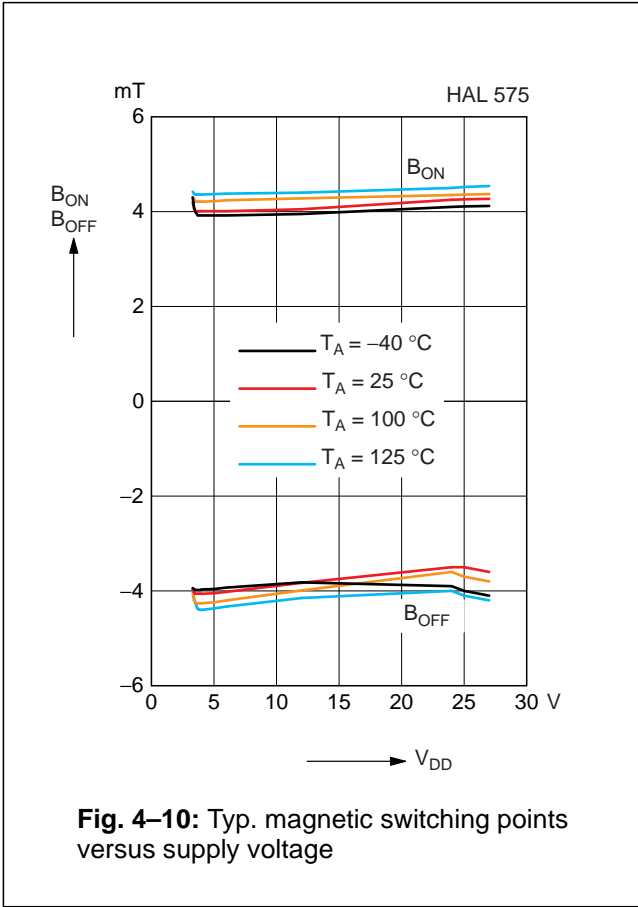
Magnetic flux density values of switching points.

Positive flux density values refer to the magnetic south pole at the branded side of the package.

Parameter	On point $B_{ON}$			Off point $B_{OFF}$			Hysteresis $B_{HYS}$			Magnetic Offset			Unit
	Min.	Typ.	Max.	Min.	Typ.	Max.	Min.	Typ.	Max.	Min.	Typ.	Max.	
$T_J$													
-40 °C	0.5	4	8	-8	-4	-0.5	5	8	11		0		mT
25 °C	0.5	4	8	-8	-4	-0.5	5	8	11		0		mT
100 °C	0.5	4	8	-8	-4	-0.5	5	8	11		0		mT
140 °C	0.5	4	8	-8	-4	-0.5	5	8	11		0		mT

The hysteresis is the difference between the switching points  $B_{HYS} = B_{ON} - B_{OFF}$

The magnetic offset is the mean value of the switching points  $B_{OFFSET} = (B_{ON} + B_{OFF}) / 2$



**Note:** In the diagram “Magnetic switching points versus temperature”, the curves for  $B_{ONmin}$ ,  $B_{ONmax}$ ,  $B_{OFFmin}$ , and  $B_{OFFmax}$  refer to junction temperature, whereas typical curves refer to ambient temperature.



**4.4. HAL576**

The HAL576 is a medium sensitive unipolar switching sensor (see Fig. 4–13).

The sensor turns to high current consumption with the magnetic south pole on the branded side of the package and turns to low current consumption if the magnetic field is removed. It does not respond to the magnetic north pole on the branded side.

For correct functioning in the application, the sensor requires only the magnetic south pole on the branded side of the package.

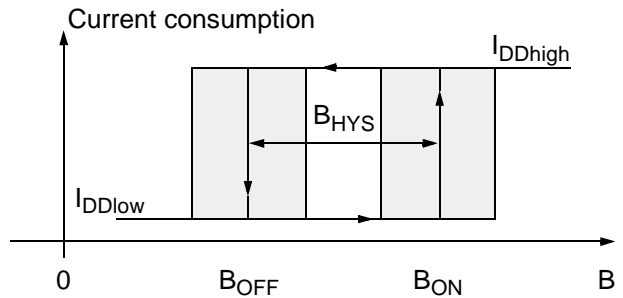
**Magnetic Features:**

- switching type: unipolar
- medium sensitivity
- typical  $B_{ON}$ : 5.7 mT at room temperature
- typical  $B_{OFF}$ : 4.2 mT at room temperature
- operates with static magnetic fields and dynamic magnetic fields up to 10 kHz

**Applications**

The HAL576 is designed for applications with one magnetic polarity and weak magnetic amplitudes at the sensor position such as:

- applications with large airgap or weak magnets,
- solid state switches,
- contactless solutions to replace micro switches,
- position and end point detection, and
- rotating speed measurement.



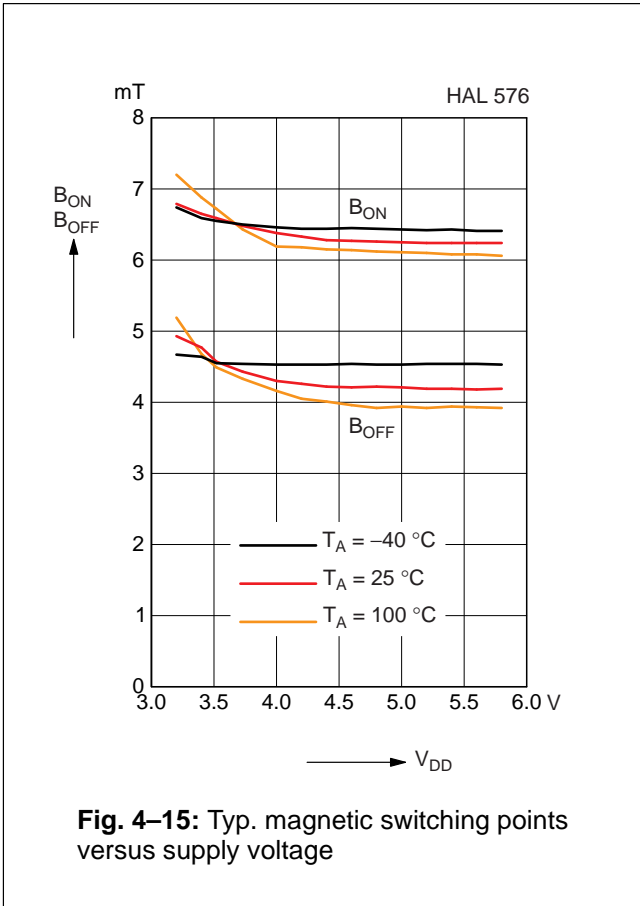
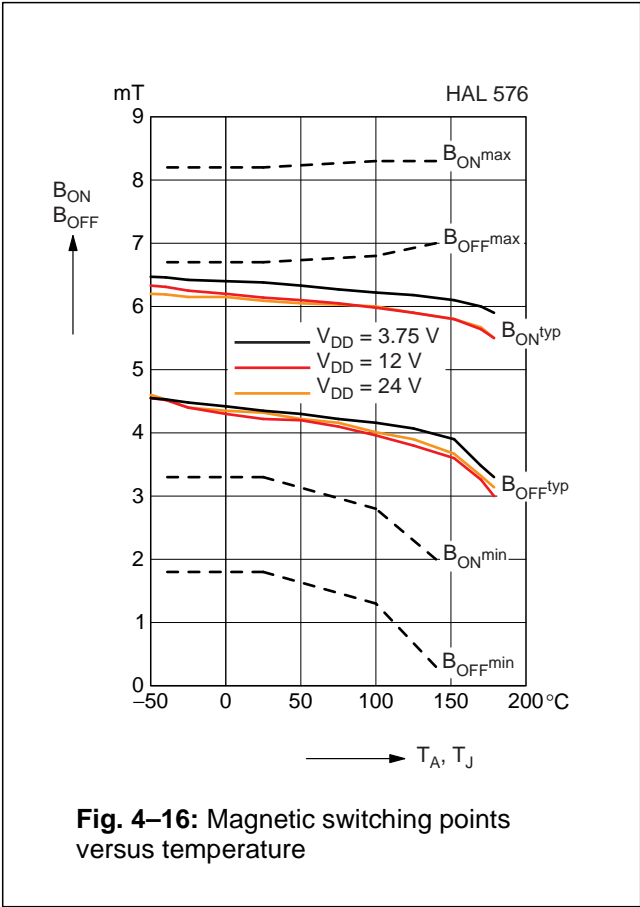
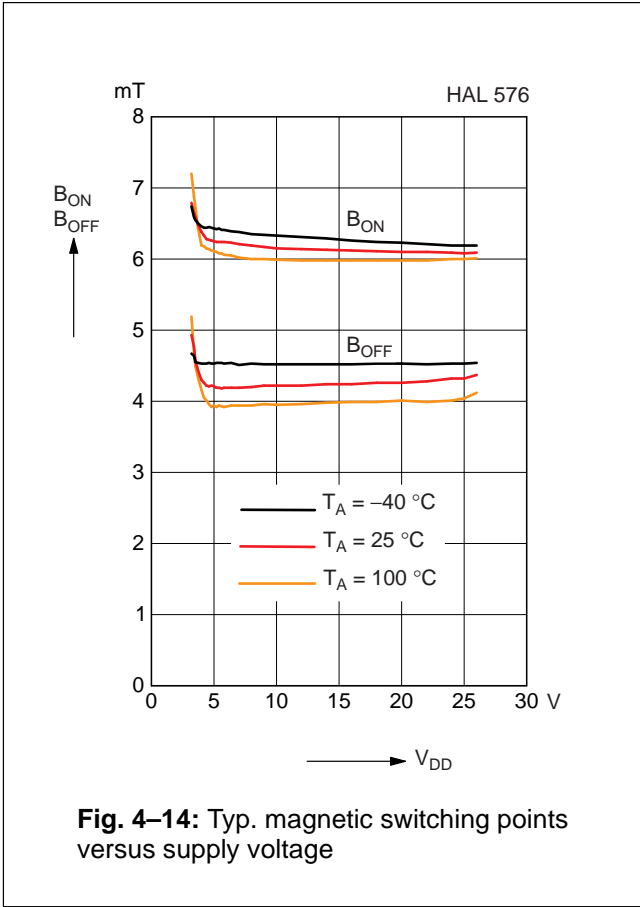
**Fig. 4–13:** Definition of magnetic switching points for the HAL576

**Magnetic Characteristics** at  $T_J = -40\text{ °C}$  to  $+140\text{ °C}$ ,  $V_{DD} = 3.75\text{ V}$  to  $24\text{ V}$ , Typical Characteristics for  $V_{DD} = 12\text{ V}$

Magnetic flux density values of switching points. Positive flux density values refer to the magnetic south pole at the branded side of the package.

Parameter $T_J$	On point $B_{ON}$			Off point $B_{OFF}$			Hysteresis $B_{HYS}$			Magnetic Offset			Unit
	Min.	Typ.	Max.	Min.	Typ.	Max.	Min.	Typ.	Max.	Min.	Typ.	Max.	
-40 °C	3.3	5.7	8.2	1.8	4.2	6.7	0.3	1.9	3.5		5		mT
25 °C	3.3	5.7	8.2	1.8	4.2	6.7	0.3	1.9	3.5		5		mT
100 °C	2.8	5.5	8.3	1.3	4	6.8	0.3	1.9	3.5		5		mT
140 °C	2	5.2	8.3	0.3	3.7	7	0.3	1.9	3.5		4.5		mT

The hysteresis is the difference between the switching points  $B_{HYS} = B_{ON} - B_{OFF}$   
 The magnetic offset is the mean value of the switching points  $B_{OFFSET} = (B_{ON} + B_{OFF}) / 2$



**Note:** In the diagram “Magnetic switching points versus temperature”, the curves for  $B_{ONmin}$ ,  $B_{ONmax}$ ,  $B_{OFFmin}$ , and  $B_{OFFmax}$  refer to junction temperature, whereas typical curves refer to ambient temperature.

**4.5. HAL579**

The HAL579 is a unipolar switching sensor with low sensitivity (see Fig. 4–17).

The sensor turns to high current consumption with the magnetic south pole on the branded side of the package and turns to low consumption with the magnetic north pole on the branded side. The current consumption does not change if the magnetic field is removed. For changing the current consumption, the opposite magnetic field polarity must be applied.

For correct functioning in the application, the sensor requires both magnetic polarities on the branded side of the package.

**Magnetic Features:**

- switching type: latching
- medium sensitivity
- typical  $B_{ON}$ : 12.0 mT at room temperature
- typical  $B_{OFF}$ : -12.0 mT at room temperature
- typical temperature coefficient of magnetic switching points is 0 ppm/K
- operates with static magnetic fields and dynamic magnetic fields up to 10 kHz

**Magnetic Characteristics** at  $T_J = -40\text{ °C}$  to  $+140\text{ °C}$ ,  $V_{DD} = 3.75\text{ V}$  to  $24\text{ V}$ , Typical Characteristics for  $V_{DD} = 12\text{ V}$

Magnetic flux density values of switching points. Positive flux density values refer to the magnetic south pole at the branded side of the package.

Parameter	On point $B_{ON}$			Off point $B_{OFF}$			Hysteresis $B_{HYS}$			Magnetic Offset			Unit
	Min.	Typ.	Max.	Min.	Typ.	Max.	Min.	Typ.	Max.	Min.	Typ.	Max.	
$T_J$ -40 °C	5.5	12.0	18.5	-18.5	-12.0	-5.5	16.0	22.0	28.0	-7.0	0.0	7.0	mT
25 °C	5.5	12.0	18.5	-18.5	-12.0	-5.5	16.0	22.0	28.0	-7.0	0.0	7.0	mT
100 °C	5.5	12.0	18.5	-18.5	-12.0	-5.5	16.0	22.0	28.0	-7.0	0.0	7.0	mT
140 °C	5.5	12.0	18.5	-18.5	-12.0	-5.5	16.0	22.0	28.0	-7.0	0.0	7.0	mT

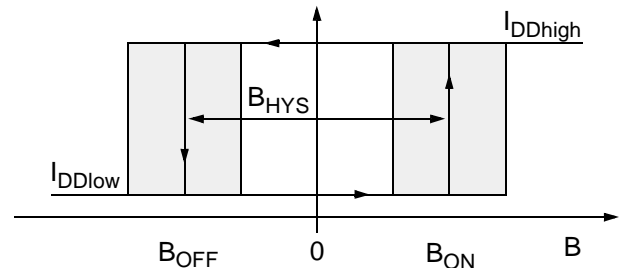
The hysteresis is the difference between the switching points  $B_{HYS} = B_{ON} - B_{OFF}$   
 The magnetic offset is the mean value of the switching points  $B_{OFFSET} = (B_{ON} + B_{OFF}) / 2$

**Applications**

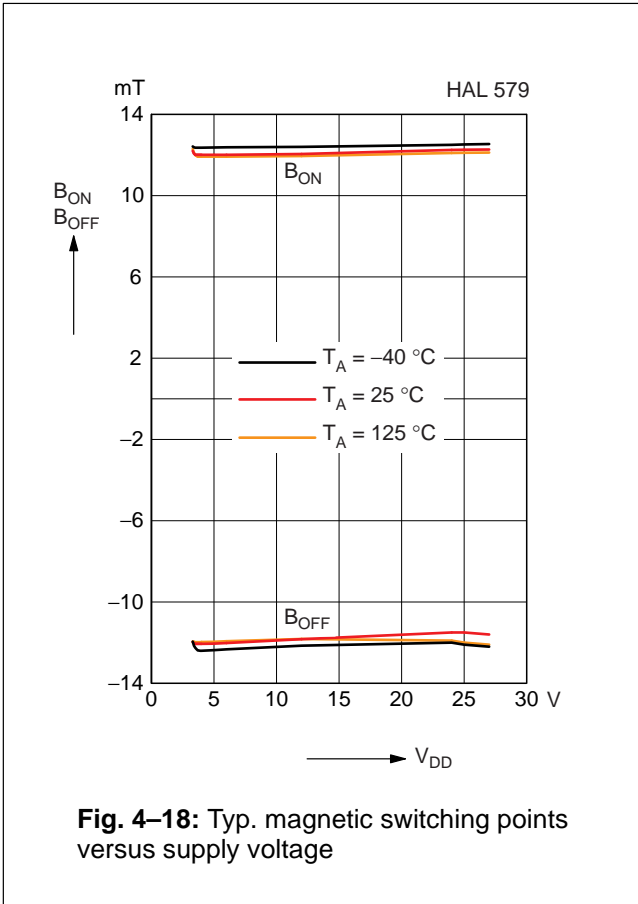
The HAL579 is designed for applications with both magnetic polarities and weak magnetic amplitudes at the sensor position such as:

- solid state switches,
- contactless solutions to replace micro switches,
- position and end point detection, and
- rotating speed measurement.

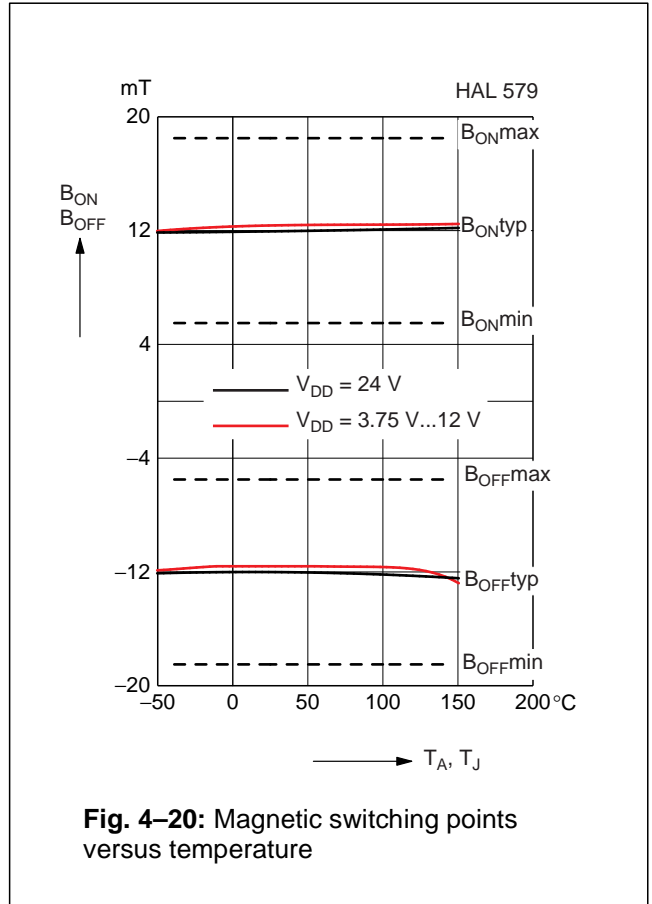
Current consumption



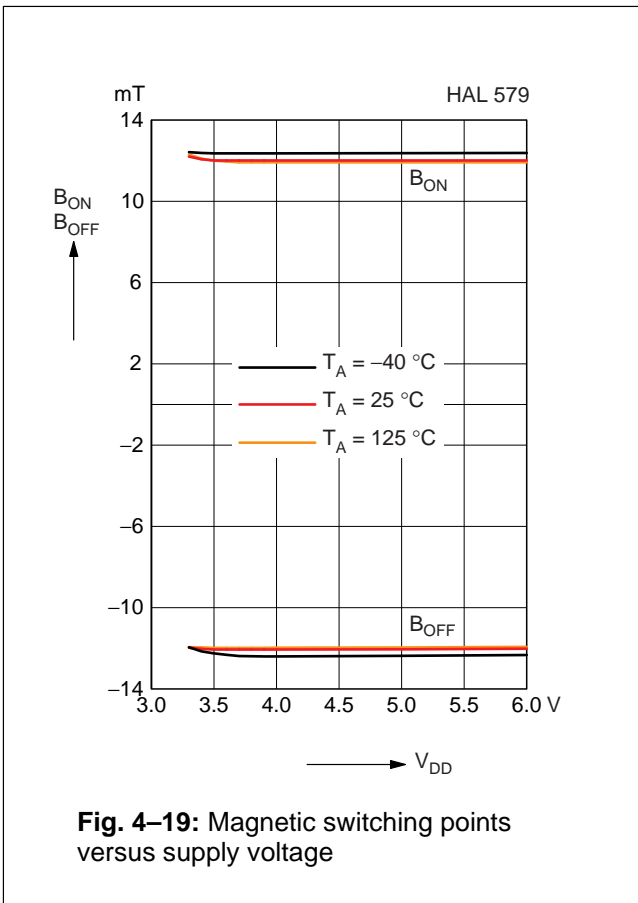
**Fig. 4–17:** Definition of magnetic switching points for the HAL579



**Fig. 4-18:** Typ. magnetic switching points versus supply voltage



**Fig. 4-20:** Magnetic switching points versus temperature



**Fig. 4-19:** Magnetic switching points versus supply voltage

**Note:** In the diagram “Magnetic switching points versus temperature” the curves for  $B_{ONmin}$ ,  $B_{ONmax}$ ,  $B_{OFFmin}$ , and  $B_{OFFmax}$  refer to junction temperature, whereas typical curves refer to ambient temperature.

**4.6. HAL581**

The HAL581 is a medium sensitive unipolar switching sensor with an inverted output (see Fig. 4–21).

The sensor turns to low current consumption with the magnetic south pole on the branded side of the package and turns to high current consumption if the magnetic field is removed. It does not respond to the magnetic north pole on the branded side.

For correct functioning in the application, the sensor requires only the magnetic south pole on the branded side of the package.

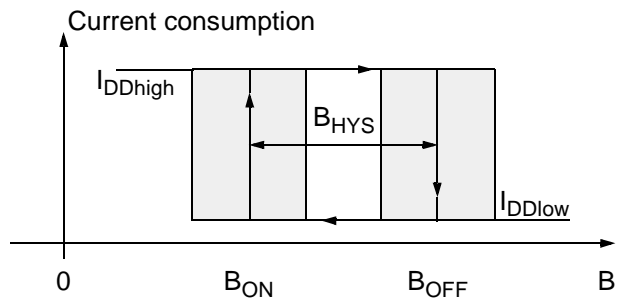
**Magnetic Features:**

- switching type: unipolar inverted
- medium sensitivity
- typical  $B_{ON}$ : 10 mT at room temperature
- typical  $B_{OFF}$ : 12 mT at room temperature
- typical temperature coefficient of magnetic switching points is 0 ppm/K
- operates with static magnetic fields and dynamic magnetic fields up to 10 kHz

**Applications**

The HAL581 is designed for applications with one magnetic polarity and weak magnetic amplitudes at the sensor position where an inverted output signal is required such as:

- applications with large airgap or weak magnets,
- solid state switches,
- contactless solutions to replace micro switches,
- position and end point detection, and
- rotating speed measurement.



**Fig. 4–21:** Definition of magnetic switching points for the HAL581

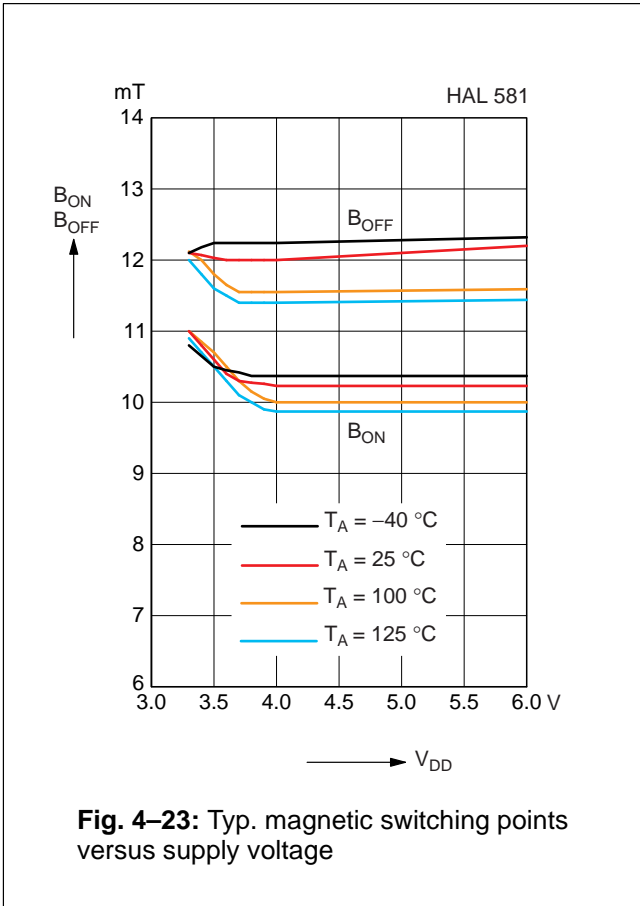
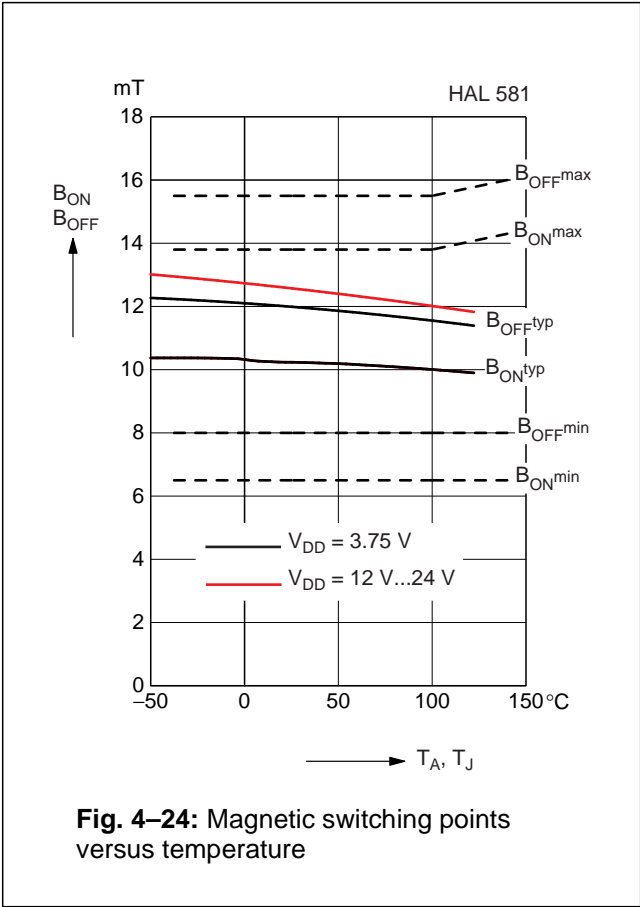
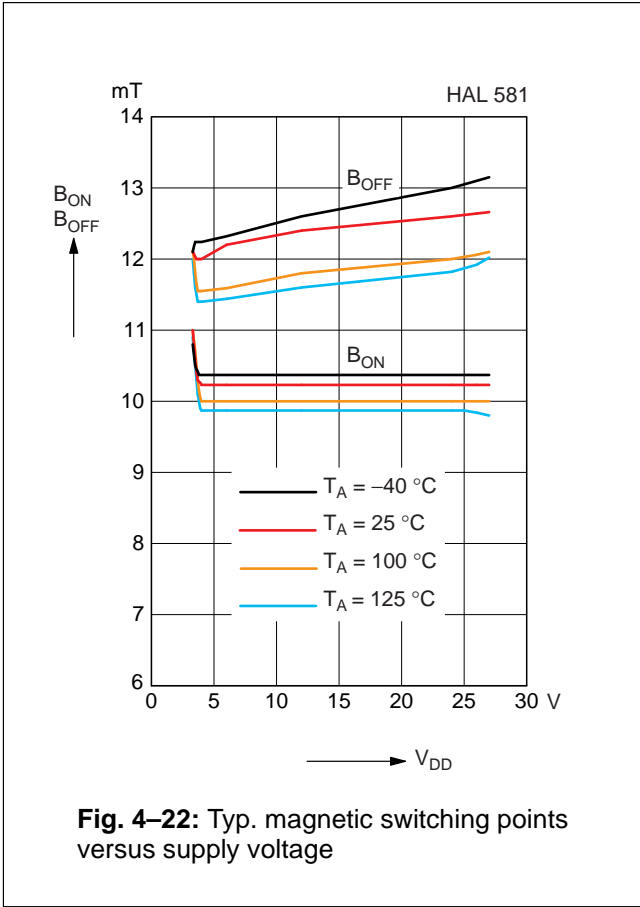
**Magnetic Characteristics** at  $T_J = -40\text{ °C}$  to  $+140\text{ °C}$ ,  $V_{DD} = 3.75\text{ V}$  to  $24\text{ V}$ ,  
 Typical Characteristics for  $V_{DD} = 12\text{ V}$

Magnetic flux density values of switching points.

Positive flux density values refer to the magnetic south pole at the branded side of the package.

Parameter	On point $B_{ON}$			Off point $B_{OFF}$			Hysteresis $B_{HYS}$			Magnetic Offset			Unit
	Min.	Typ.	Max.	Min.	Typ.	Max.	Min.	Typ.	Max.	Min.	Typ.	Max.	
$T_J$													
-40 °C	6.5	10	13.8	8	12	15.5	0.5	2	3.5		11		mT
25 °C	6.5	10	13.8	8	12	15.5	0.5	2	3.5		11		mT
100 °C	6.5	10	13.8	8	12	15.5	0.5	2	3.5		11		mT
140 °C	6.5	10.4	14.3	8	12	16	0.5	2	3.5		11		mT

The hysteresis is the difference between the switching points  $B_{HYS} = B_{ON} - B_{OFF}$   
 The magnetic offset is the mean value of the switching points  $B_{OFFSET} = (B_{ON} + B_{OFF}) / 2$



**Note:** In the diagram “Magnetic switching points versus temperature”, the curves for  $B_{ONmin}$ ,  $B_{ONmax}$ ,  $B_{OFFmin}$ , and  $B_{OFFmax}$  refer to junction temperature, whereas typical curves refer to ambient temperature.

**4.7. HAL584**

The HAL584 is a medium sensitive unipolar switching sensor with an inverted output (see Fig. 4–25).

The sensor turns to low current consumption with the magnetic south pole on the branded side of the package and turns to high current consumption if the magnetic field is removed. It does not respond to the magnetic north pole on the branded side.

For correct functioning in the application, the sensor requires only the magnetic south pole on the branded side of the package.

In this two-wire sensor family, the HAL574 is a sensor with the same magnetic characteristics but with a normal output characteristic.

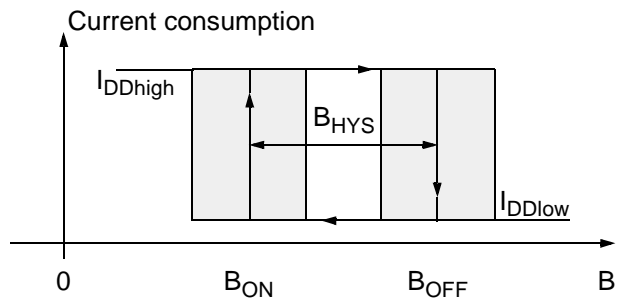
**Magnetic Features:**

- switching type: unipolar inverted
- medium sensitivity
- typical  $B_{ON}$ : 7.2 mT at room temperature
- typical  $B_{OFF}$ : 9.2 mT at room temperature
- typical temperature coefficient of magnetic switching points is 0 ppm/K
- operates with static magnetic fields and dynamic magnetic fields up to 10 kHz

**Applications**

The HAL584 is designed for applications with one magnetic polarity and weak magnetic amplitudes at the sensor position where an inverted output signal is required such as:

- applications with large airgap or weak magnets,
- solid state switches,
- contactless solutions to replace micro switches,
- position and end point detection, and
- rotating speed measurement.



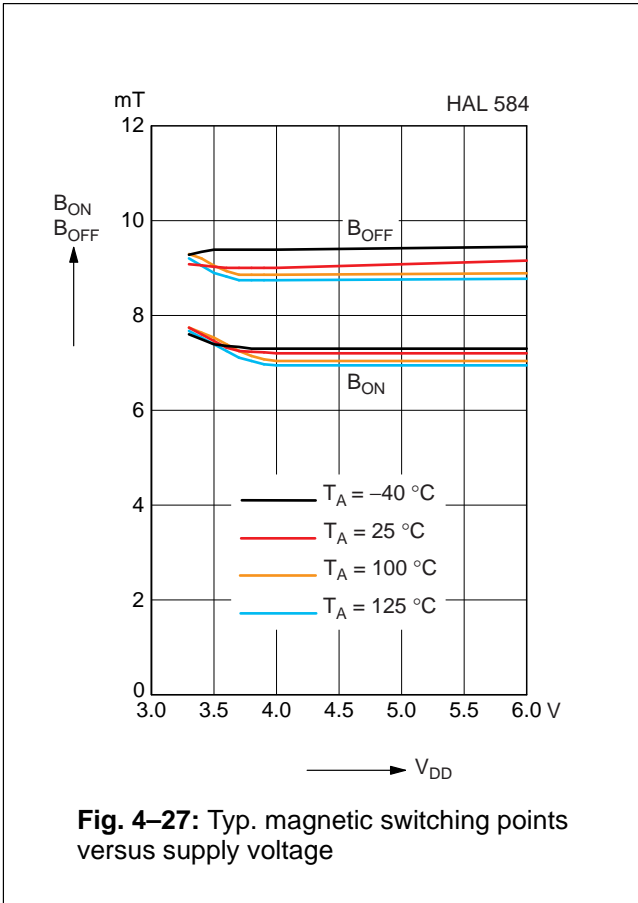
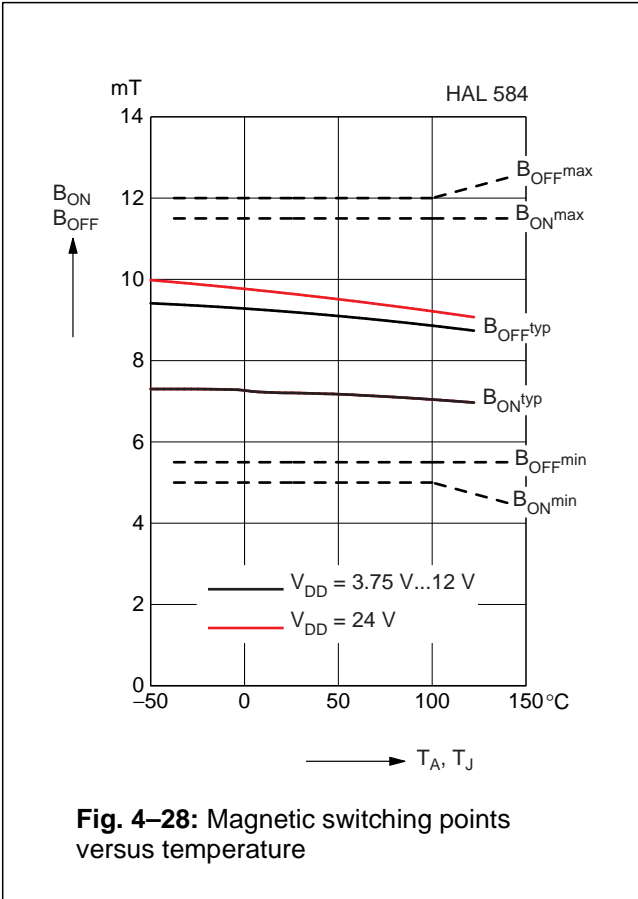
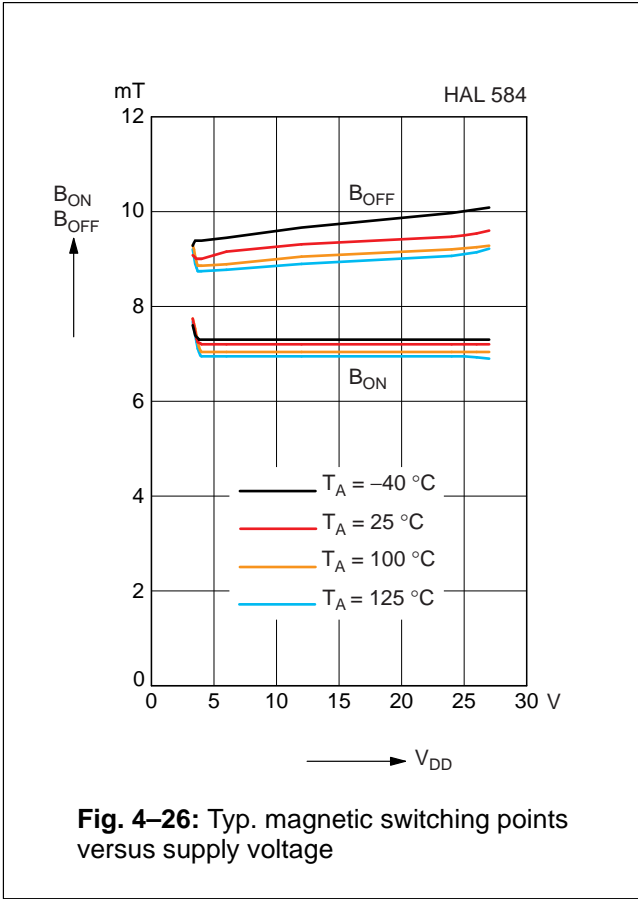
**Fig. 4–25:** Definition of magnetic switching points for the HAL584

**Magnetic Characteristics** at  $T_J = -40\text{ °C}$  to  $+140\text{ °C}$ ,  $V_{DD} = 3.75\text{ V}$  to  $24\text{ V}$ , Typical Characteristics for  $V_{DD} = 12\text{ V}$

Magnetic flux density values of switching points. Positive flux density values refer to the magnetic south pole at the branded side of the package.

Parameter	On point $B_{ON}$			Off point $B_{OFF}$			Hysteresis $B_{HYS}$			Magnetic Offset			Unit
	Min.	Typ.	Max.	Min.	Typ.	Max.	Min.	Typ.	Max.	Min.	Typ.	Max.	
$T_J$													
-40 °C	5	7.2	11.5	5.5	9.2	12	0.5	2	3.0		8.2		mT
25 °C	5	7.2	11.5	5.5	9.2	12	0.5	2	3.0		8.2		mT
100 °C	5	7.2	11.5	5.5	9.2	12	0.5	2	3.0		8.2		mT
140 °C	4.5	8	11.5	5.5	9	12.5	0.2	1.9	3.5		8.2		mT

The hysteresis is the difference between the switching points  $B_{HYS} = B_{ON} - B_{OFF}$   
 The magnetic offset is the mean value of the switching points  $B_{OFFSET} = (B_{ON} + B_{OFF}) / 2$



**Note:** In the diagram “Magnetic switching points versus temperature”, the curves for  $B_{ONmin}$ ,  $B_{ONmax}$ ,  $B_{OFFmin}$ , and  $B_{OFFmax}$  refer to junction temperature, whereas typical curves refer to ambient temperature.

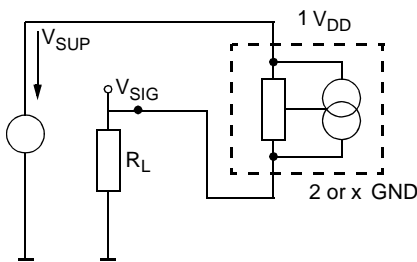


5. Application Notes

5.1. Application Circuit

Fig. 5–1 shows a simple application with a two-wire sensor. The current consumption can be detected by measuring the voltage over  $R_L$ . For correct functioning of the sensor, the voltage between pin 1 and 2 ( $V_{DD}$ ) must be a minimum of 3.75 V. With the maximum current consumption of 17 mA, the maximum  $R_L$  can be calculated as:

$$R_{Lmax} = \frac{V_{SUPmin} - 3.75 \text{ V}}{17 \text{ mA}}$$

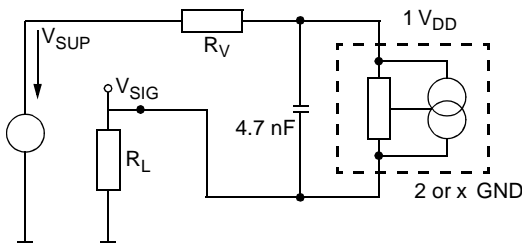


x = pin 3 for TO92UA-1/-2 package  
 x = pin 4 for SOT89B-1 package

Fig. 5–1: Application circuit 1

For applications with disturbances on the supply line or radiated disturbances, a series resistor  $R_V$  (ranging from 10  $\Omega$  to 30  $\Omega$ ) and a capacitor both placed close to the sensor are recommended (see Fig. 5–2). In this case, the maximum  $R_L$  can be calculated as:

$$R_{Lmax} = \frac{V_{SUPmin} - 3.75 \text{ V}}{17 \text{ mA}} - R_V$$



x = pin 3 for TO92UA-1/-2 package  
 x = pin 4 for SOT89B-1 package

Fig. 5–2: Application circuit 2

5.2. Extended Operating Conditions

All sensors fulfill the electrical and magnetic characteristics when operated within the Recommended Operating Conditions (see page 14).

Typically, the sensors operate with supply voltages above 3 V. However, below 3.75 V, the current consumption and the magnetic characteristics may be outside the specification.

**Note:** The functionality of the sensor below 3.75 V is not tested on a regular base. For special test conditions, please contact Micronas.

5.3. Start-Up Behavior

Due to the active offset compensation, the sensors have an initialization time (enable time  $t_{en(O)}$ ) after applying the supply voltage. The parameter  $t_{en(O)}$  is specified in the Electrical Characteristics (see page 15). During the initialization time, the current consumption is not defined and can toggle between low and high.

HAL57x

After  $t_{en(O)}$ , the current consumption will be high if the applied magnetic field  $B$  is above  $B_{ON}$ . The current consumption will be low if  $B$  is below  $B_{OFF}$ .

HAL58x

In case of sensors with an inverted switching behavior, the current consumption will be low if  $B > B_{OFF}$  and high if  $B < B_{ON}$ .

**Note:** For magnetic fields between  $B_{OFF}$  and  $B_{ON}$ , the current consumption of the HAL sensor will be either low or high after applying  $V_{DD}$ . In order to achieve a defined current consumption, the applied magnetic field must be above  $B_{ON}$ , respectively, below  $B_{OFF}$ .

**5.4. Ambient Temperature**

Due to internal power dissipation, the temperature on the silicon chip (junction temperature  $T_J$ ) is higher than the temperature outside the package (ambient temperature  $T_A$ ).

$$T_J = T_A + \Delta T$$

At static conditions and continuous operation, the following equation applies:

$$\Delta T = I_{DD} \times V_{DD} \times R_{th}$$

For all sensors, the junction temperature range  $T_J$  is specified. The maximum ambient temperature  $T_{Amax}$  can be calculated as:

$$T_{Amax} = T_{Jmax} - \Delta T$$

For typical values, use the typical parameters. For worst case calculation, use the max. parameters for  $I_{DD}$  and  $R_{th}$ , and the max. value for  $V_{DD}$  from the application.

Due to the range of  $I_{DDhigh}$ , self-heating can be critical. The junction temperature can be reduced with pulsed supply voltage. For supply times ( $t_{on}$ ) ranging from 30  $\mu s$  to 1 ms, the following equation can be used:

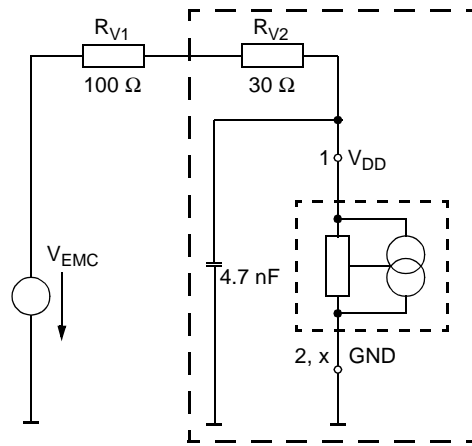
$$T = I_{DD} \times V_{DD} \times R_{th} \times \frac{t_{on}}{t_{off} + t_{on}}$$

**5.5. EMC and ESD**

For applications with disturbances on the supply line or radiated disturbances, a series resistor and a capacitor are recommended (see Fig. 5–3). The series resistor and the capacitor should be placed as closely as possible to the HAL sensor.

Applications with this arrangement passed the EMC tests according to the product standards ISO 7637.

Please contact Micronas for detailed information and first EMC and ESD results.



x = pin 3 for TO92UA-1/-2 package  
 x = pin 4 for SOT89B-1 package

**Fig. 5–3:** Recommended EMC test circuit

**intentionally left vacant**

---

## 6. Data Sheet History

1. Data sheet: "HAL574...HAL576, 581, 584 Two-wire Hall Effect Sensor Family", April 11, 2002 6251-538-1DS. First release of the data sheet. Major changes:
  - "K" temperature range specified
  - HAL571 and HAL573 deleted
  - HAL576 added
2. Data Sheet: "HAL573...HAL576, HAL581...HAL584 Two-Wire Hall Effect Sensor Family", Nov. 27, 2003, 6251-538-2DS. Second release of the data sheet. Major changes:
  - specification for HAL573 added
  - new package diagrams for SOT89B-1 and TO92UA-1
  - package diagram for TO92UA-2 added
  - ammpack diagrams for TO92UA-1/-2 added
3. Data Sheet: "HAL573...HAL576, HAL579 HAL581...HAL584 Two-Wire Hall-Effect Sensor Family", Nov. 5, 2007, DSH000145\_001EN. Third release of the data sheet. Major changes:
  - specification for HAL579 added
  - specification for HAL573 updated
  - package diagrams for SOT89B-1, TO92UA-1, and TO92UA-2 updated
4. Data Sheet: "HAL573...HAL576, HAL579 HAL581...HAL584 Two-Wire Hall-Effect Sensor Family", March 7, 2008, DSH000145\_002EN. Fourth release of the data sheet. Minor changes:
  - specification for HAL579 updated
  - ammpack diagrams for TO92UA-1 and TO92UA-2 updated
5. Data Sheet: "HAL573...HAL576, HAL579 HAL581...HAL584 Two-Wire Hall-Effect Sensor Family", Dec. 22, 2008, DSH000145\_003EN. Fifth release of the data sheet. Major changes:
  - Section 1.6. Solderability and Welding updated
  - Section 3.5. Recommended Operating Conditions updated