

HAT2024R

Silicon N Channel Power MOS FET
High Speed Power Switching

HITACHI

ADE-208-494 C (Z)
4th. Edition
July 1997

Features

- Low on-resistance
- Capable of 4 V gate drive
- Low drive current
- High density mounting

Outline

SOP-8

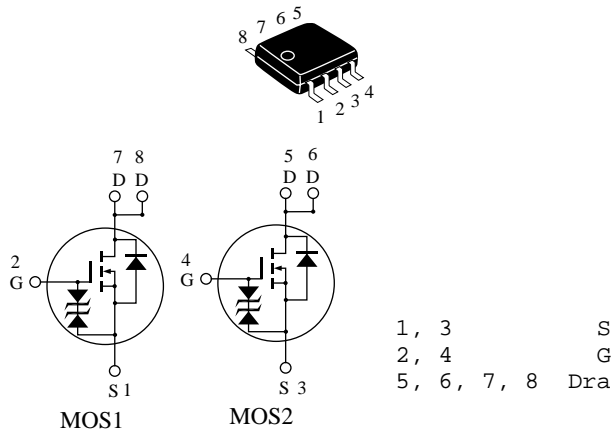

Absolute Maximum Ratings (Ta = 25°C)

| Item | Symbol | Ratings | Unit |
|---|---------------------|-------------|------|
| Drain to source voltage | V_{DSS} | 30 | V |
| Gate to source voltage | V_{GSS} | ±20 | V |
| Drain current | I_D | 5.5 | A |
| Drain peak current | $I_{D(pulse)}^{*1}$ | 44 | A |
| Body to drain diode reverse drain current | I_{DR} | 5.5 | A |
| Channel dissipation | Pch^{*2} | 2 | W |
| Channel dissipation | Pch^{*3} | 3 | W |
| Channel temperature | Tch | 150 | °C |
| Storage temperature | $Tstg$ | -55 to +150 | °C |

Notes: 1. $PW \leq 10\mu s$, duty cycle $\leq 1\%$

2. 1 Drive operation : When using the glass epoxy board (FR4 40 x 40 x 1.6 mm), $PW \leq 10s$

3. 2 Drive operation : When using the glass epoxy board (FR4 40 x 40 x 1.6 mm), $PW \leq 10s$

Electrical Characteristics (Ta = 25°C)

| Item | Symbol | Min | Typ | Max | Unit | Test Conditions |
|--|---------------|----------|-------|----------|---------------|--|
| Drain to source breakdown voltage | $V_{(BR)DSS}$ | 30 | — | — | V | $I_D = 10\text{mA}, V_{GS} = 0$ |
| Gate to source breakdown voltage | $V_{(BR)GSS}$ | ± 20 | — | — | V | $I_G = \pm 100\mu\text{A}, V_{DS} = 0$ |
| Gate to source leak current | I_{GSS} | — | — | ± 10 | μA | $V_{GS} = \pm 16\text{V}, V_{DS} = 0$ |
| Zero gate voltage drain current | I_{DSS} | — | — | 10 | μA | $V_{DS} = 30\text{V}, V_{GS} = 0$ |
| Gate to source cutoff voltage | $V_{GS(off)}$ | 1.0 | — | 2.0 | V | $V_{DS} = 10\text{V}, I_D = 1\text{mA}$ |
| Static drain to source on state resistance | $R_{DS(on)}$ | — | 0.05 | 0.065 | Ω | $I_D = 3\text{A}, V_{GS} = 10\text{V}^{*1}$ |
| | $R_{DS(on)}$ | — | 0.078 | 0.11 | Ω | $I_D = 3\text{A}, V_{GS} = 4\text{V}^{*1}$ |
| Forward transfer admittance | $ y_{fs} $ | 3.5 | 5.5 | — | S | $I_D = 3\text{A}, V_{DS} = 10\text{V}^{*1}$ |
| Input capacitance | C_{iss} | — | 310 | — | pF | $V_{DS} = 10\text{V}$ |
| Output capacitance | C_{oss} | — | 220 | — | pF | $V_{GS} = 0$ |
| Reverse transfer capacitance | C_{rss} | — | 100 | — | pF | $f = 1\text{MHz}$ |
| Turn-on delay time | $t_{d(on)}$ | — | 17 | — | ns | $V_{GS} = 4\text{V}, I_D = 3\text{A}$ |
| Rise time | t_r | — | 190 | — | ns | $V_{DD} \cong 10\text{V}$ |
| Turn-off delay time | $t_{d(off)}$ | — | 25 | — | ns | |
| Fall time | t_f | — | 60 | — | ns | |
| Body to drain diode forward voltage | V_{DF} | — | 0.9 | 1.4 | V | $I_F = 5.5\text{A}, V_{GS} = 0^{*1}$ |
| Body to drain diode reverse recovery time | t_{rr} | — | 50 | — | ns | $I_F = 5.5\text{A}, V_{GS} = 0$ $diF/dt = 20\text{A}/\mu\text{s}$ |

Note: 1. Pulse test

Main Characteristics

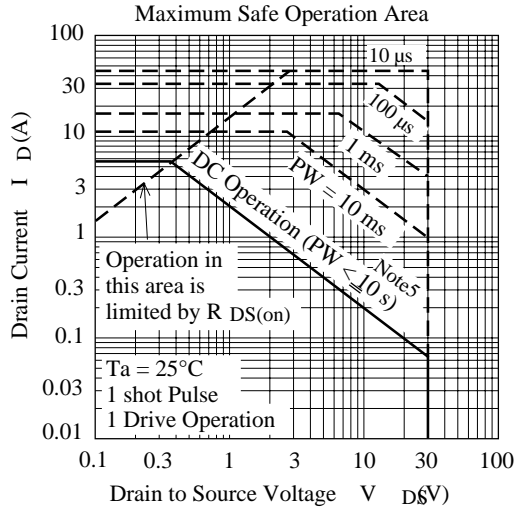
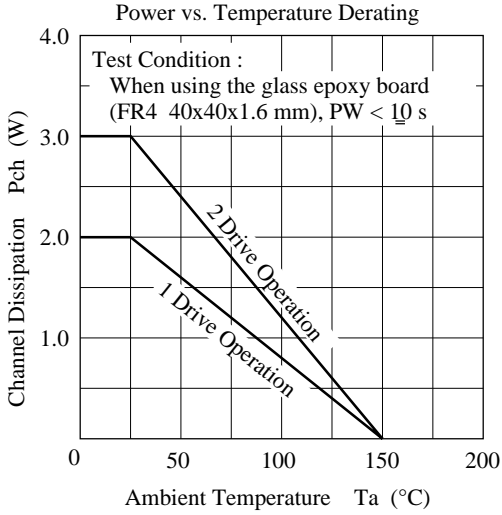

Note 5 :
When using the glass epoxy board
(FR4 40x40x1.6 mm)

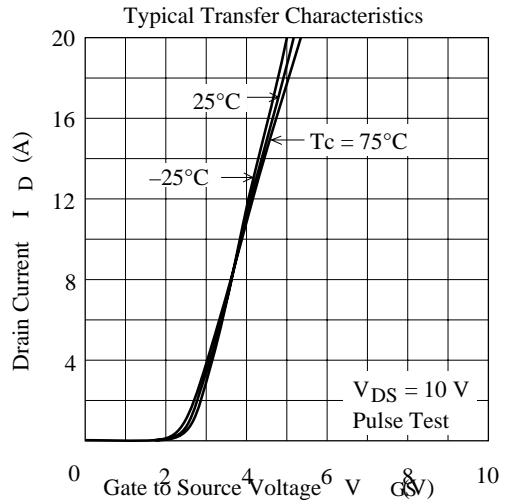
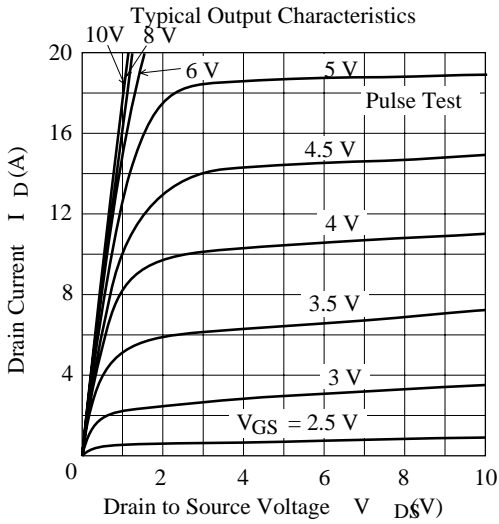

Drain to Source Saturation Voltage vs. Gate to Source Voltage

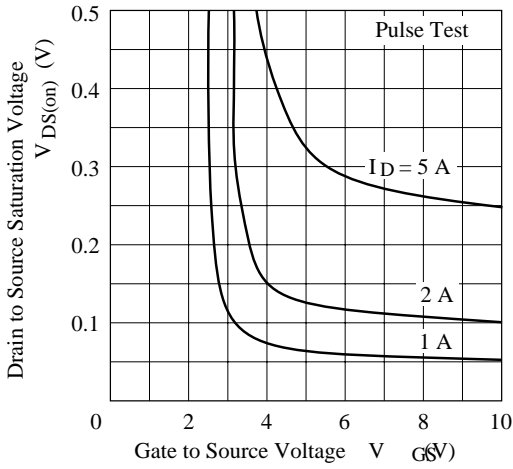

Static Drain to Source on State Resistance vs. Drain Current

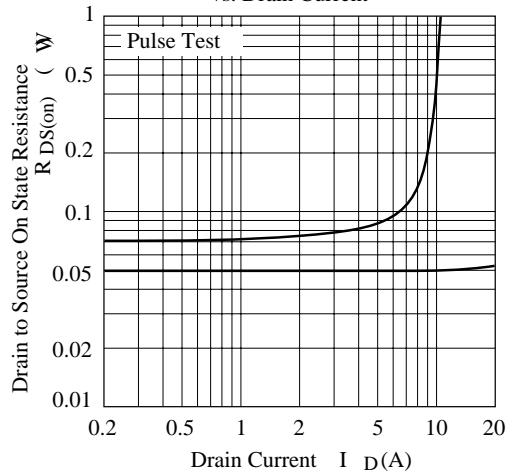

Static Drain to Source on State Resistance vs. Temperature

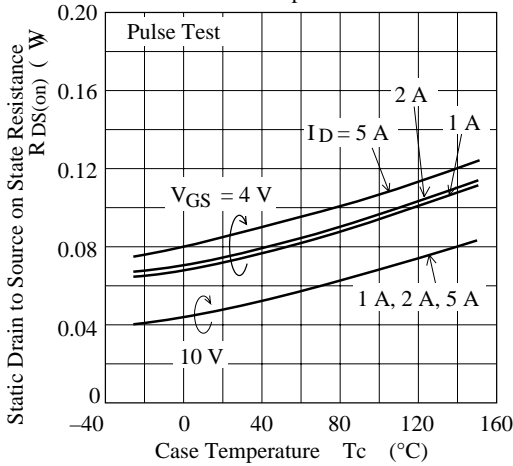

Forward Transfer Admittance vs. Drain Current

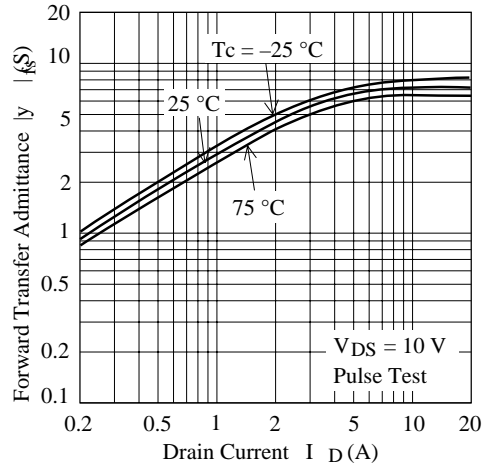

Body-Drain Diode Reverse Recovery Time

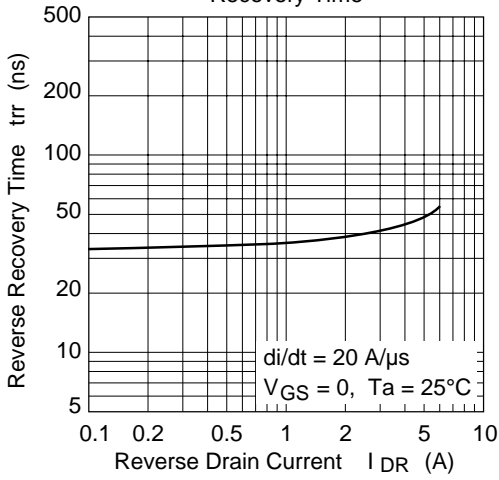

Typical Capacitance vs. Drain to Source Voltage

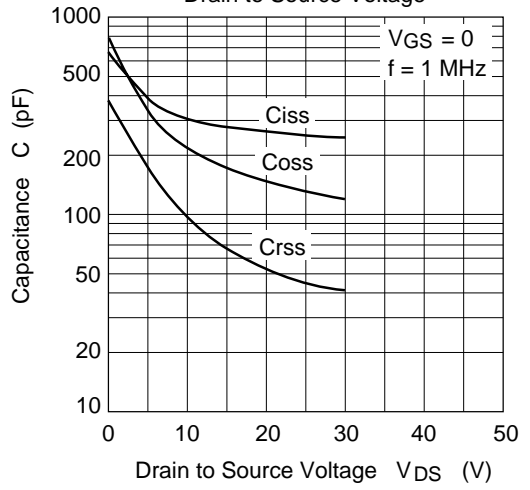

Dynamic Input Characteristics

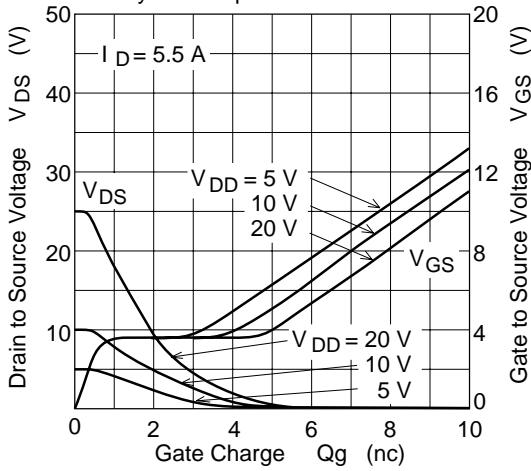

Reverse Drain Current vs. Source to Drain Voltage

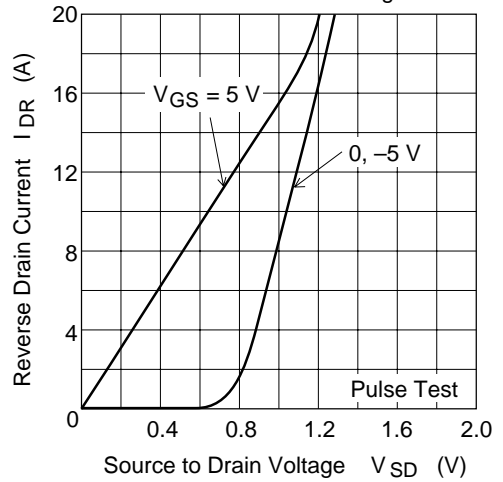

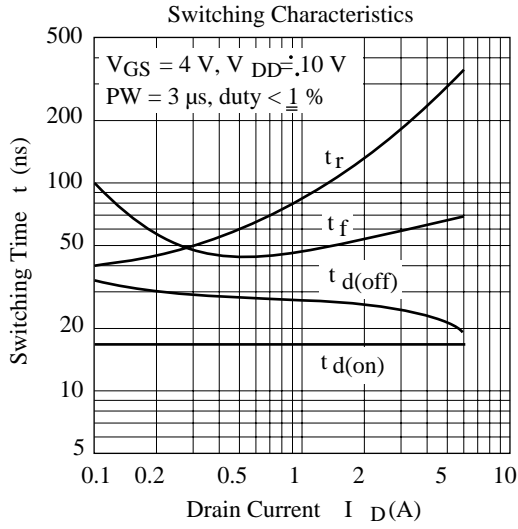

Switching Time Test Circuit

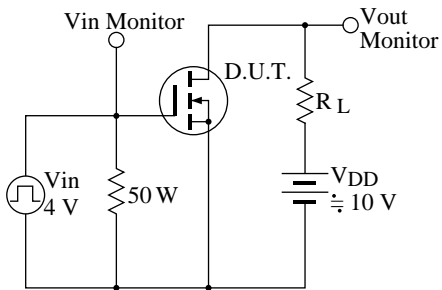

Switching Time Waveform

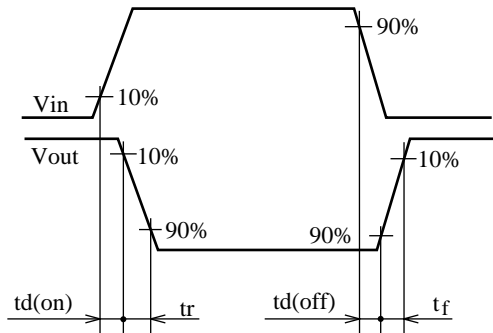

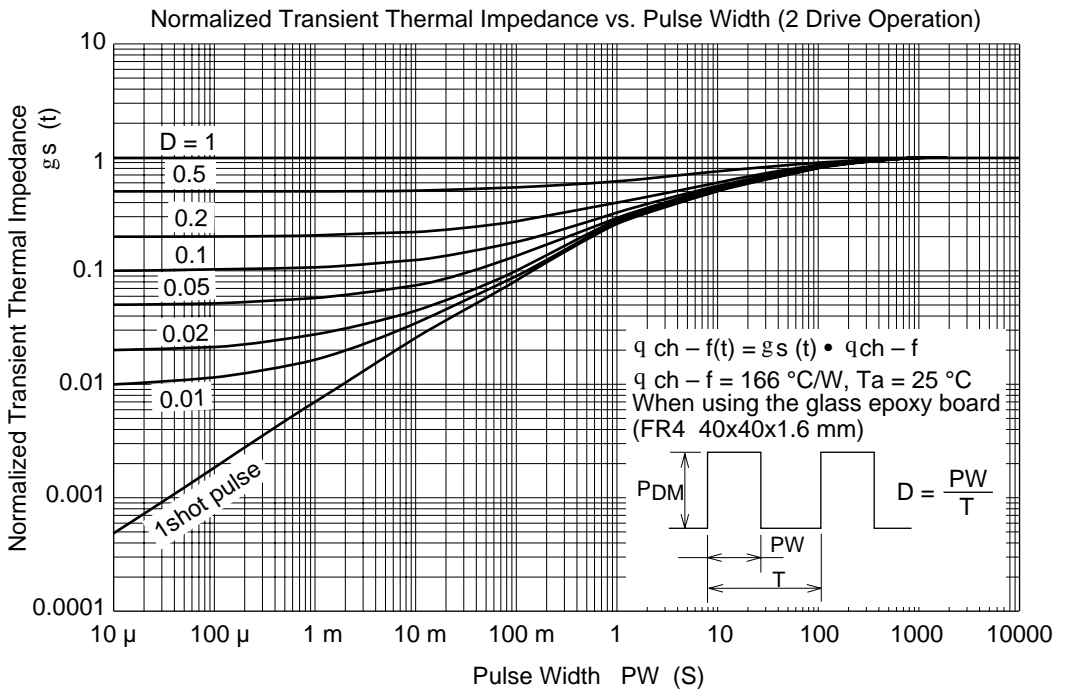
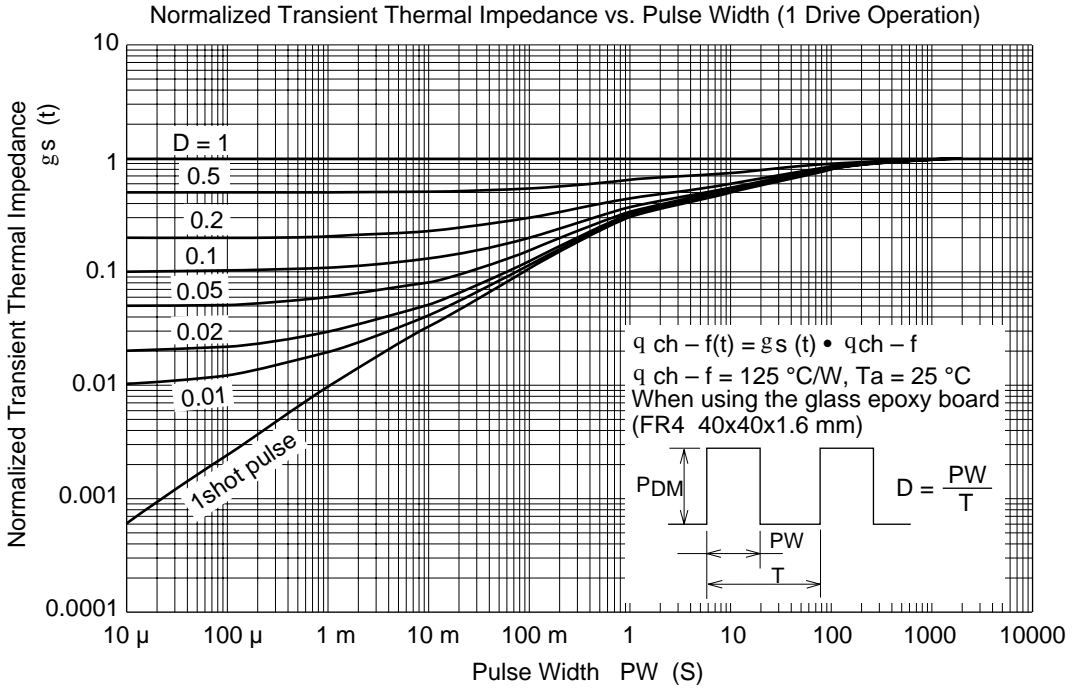

Package Dimensions

Unit: mm

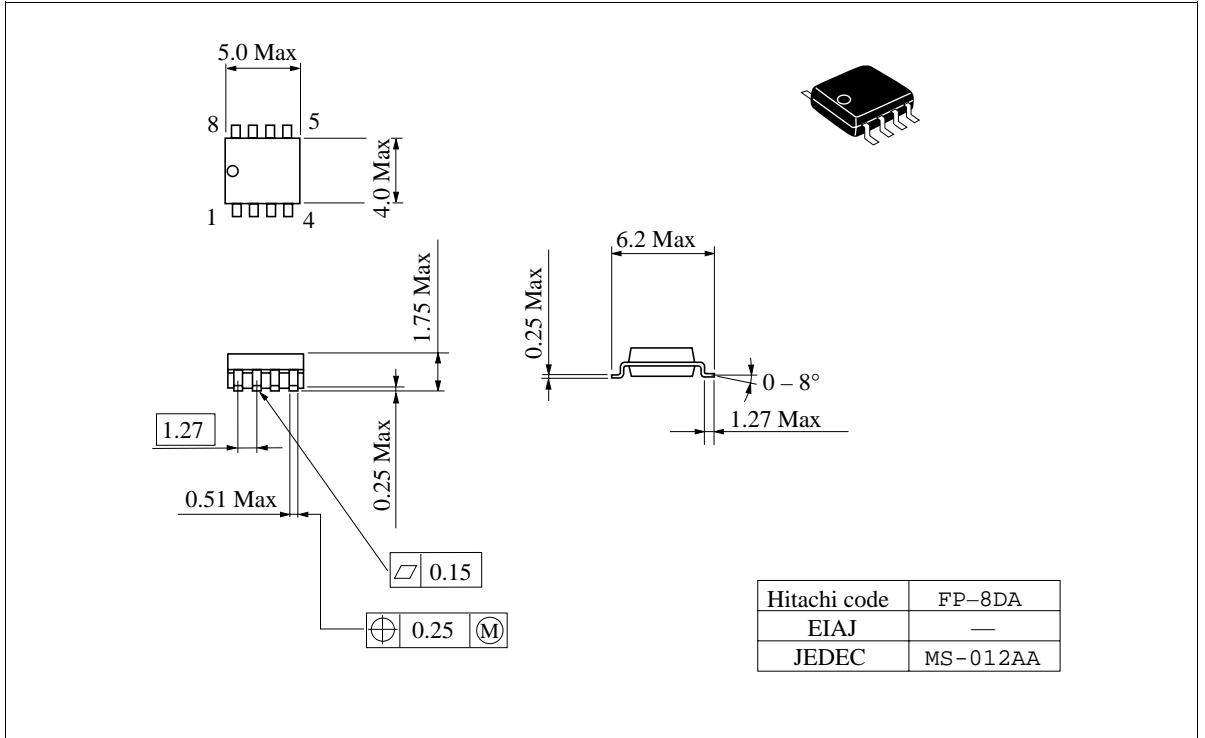

Cautions

1. Hitachi neither warrants nor grants licenses of any rights of Hitachi's or any third party's patent, copyright, trademark, or other intellectual property rights for information contained in this document. Hitachi bears no responsibility for problems that may arise with third party's rights, including intellectual property rights, in connection with use of the information contained in this document.
2. Products and product specifications may be subject to change without notice. Confirm that you have received the latest product standards or specifications before final design, purchase or use.
3. Hitachi makes every attempt to ensure that its products are of high quality and reliability. However, contact Hitachi's sales office before using the product in an application that demands especially high quality and reliability or where its failure or malfunction may directly threaten human life or cause risk of bodily injury, such as aerospace, aeronautics, nuclear power, combustion control, transportation, traffic, safety equipment or medical equipment for life support.
4. Design your application so that the product is used within the ranges guaranteed by Hitachi particularly for maximum rating, operating supply voltage range, heat radiation characteristics, installation conditions and other characteristics. Hitachi bears no responsibility for failure or damage when used beyond the guaranteed ranges. Even within the guaranteed ranges, consider normally foreseeable failure rates or failure modes in semiconductor devices and employ systemic measures such as fail-safes, so that the equipment incorporating Hitachi product does not cause bodily injury, fire or other consequential damage due to operation of the Hitachi product.
5. This product is not designed to be radiation resistant.
6. No one is permitted to reproduce or duplicate, in any form, the whole or part of this document without written approval from Hitachi.
7. Contact Hitachi's sales office for any questions regarding this document or Hitachi semiconductor products.

HITACHI

Hitachi, Ltd.

Semiconductor & IC Div.
Nippon Bldg., 2-6-2, Ohte-machi, Chiyoda-ku, Tokyo 100-0004, Japan
Tel: Tokyo (03) 3270-2111 Fax: (03) 3270-5109

URL North America : <http://semiconductor.hitachi.com/>
Europe : <http://www.hitachi-eu.com/hel/ecg>
Asia (Singapore) : <http://www.has.hitachi.com.sg/grp3/sicd/index.htm>
Asia (Taiwan) : http://www.hitachi.com.tw/E/Product/SICD_Frame.htm
Asia (HongKong) : <http://www.hitachi.com.hk/eng/bo/grp3/index.htm>
Japan : <http://www.hitachi.co.jp/Sicd/indx.htm>

For further information write to:

Hitachi Semiconductor
(America) Inc.
2000 Sierra Point Parkway
Brisbane, CA 94005-1897
Tel: <1> (800) 285-1601
Fax: <1> (303) 297-0447

Hitachi Europe GmbH
Electronic components Group
Dornacher Straße 3
D-85622 Feldkirchen, Munich
Germany
Tel: <49> (89) 9 9180-0
Fax: <49> (89) 9 29 30 00
Hitachi Europe Ltd.
Electronic Components Group.
Whitebrook Park
Lower Cookham Road
Maidenhead
Berkshire SL6 8YA, United Kingdom
Tel: <44> (1628) 585000
Fax: <44> (1628) 778322

Hitachi Asia Pte. Ltd.
16 Collyer Quay #20-00
Hitachi Tower
Singapore 049318
Tel: 535-2100
Fax: 535-1533

Hitachi Asia Ltd.
Taipei Branch Office
3F, Hung Kuo Building, No.167,
Tun-Hwa North Road, Taipei (105)
Tel: <886> (2) 2718-3666
Fax: <886> (2) 2718-8180

Hitachi Asia (Hong Kong) Ltd.
Group III (Electronic Components)
7/F., North Tower, World Finance Centre,
Harbour City, Canton Road, Tsim Sha Tsui,
Kowloon, Hong Kong
Tel: <852> (2) 735 9218
Fax: <852> (2) 730 0281
Telex: 40815 HITEC HX

Copyright © Hitachi, Ltd., 1998. All rights reserved. Printed in Japan.

HITACHI