

PNP and NPN Dual Digital Transistors

HBCA114YS6R

Features

- Built-in bias resistors enable the configuration of an inverter circuit without connecting external input resistors (see equivalent circuit).
- The bias resistors consist of thin-film resistors with complete isolation to allow positive biasing of the input for PNP transistor, and negative biasing of the input for NPN transistor. They also have the advantage of almost completely eliminating parasitic effects.
- Only the on/off conditions need to be set for operation, making device design easy.
- One DTA114Y chip and one DTC114Y chip in a SOT-363 package.
- Mounting by SOT-323 automatic mounting machines is possible.
- Mounting cost and area can be cut in half.
- Transistor elements are independent, eliminating interference.
- Pb-free lead plating and halogen-free package.

Equivalent Circuit

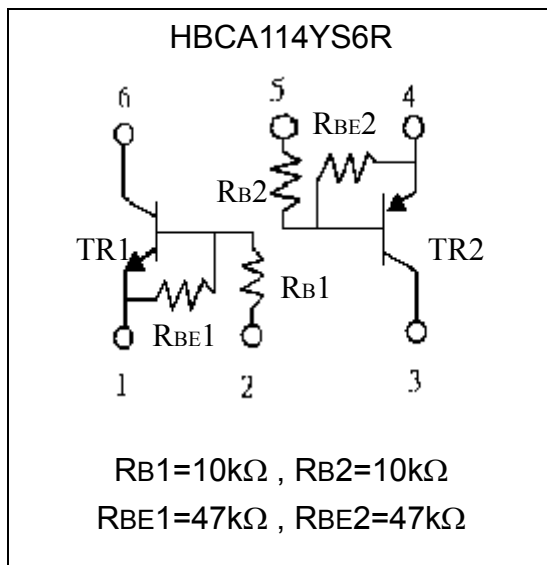

Outline

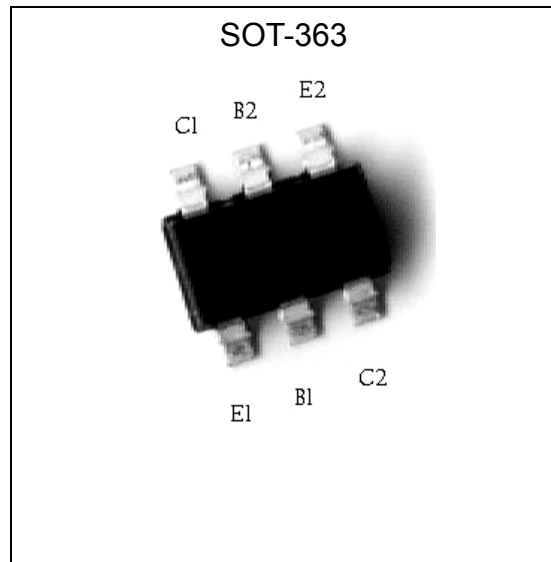



Ordering Information

Device	Package	Shipping
HBCA114YS6R-0-T1-G	SOT-363 (Pb-free lead plating and halogen-free package)	3000 pcs / Tape & Reel

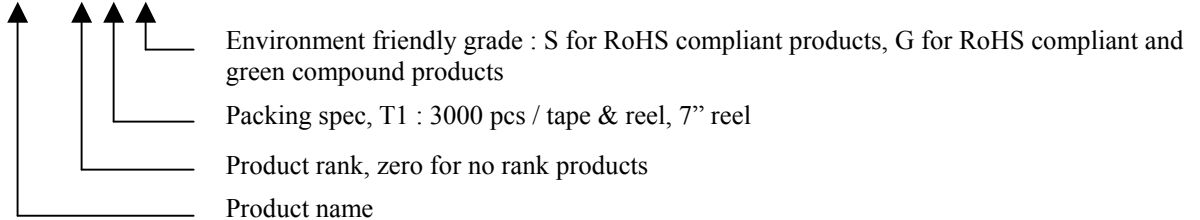

Absolute Maximum Ratings (Ta=25°C)

Parameter	Symbol	Limits		Unit
		Tr1(NPN)	Tr2(PNP)	
Supply Voltage	V _{CC}	50	-50	V
Input Voltage	V _{IN}	-6~+40	-40~+6	V
Output Current	I _O	70	-70	mA
	I _{O(max.)}	100	-100	mA
Total Power Dissipation	P _d	150 (Note)		mW
Junction Temperature	T _j	150		°C
Storage Temperature	T _{stg}	-55~+150		°C

Note : 120mW per element must not be exceeded.

Characteristics (Ta=25°C)

•Tr1(NPN)

Parameter	Symbol	Min.	Typ.	Max.	Unit	Test Conditions
Input Voltage	V _{I(off)}	-	-	0.3	V	V _{CC} =5V, I _O =100μA
	V _{I(on)}	3	-	-	V	V _O =0.3V, I _O =1mA
Output Voltage	V _{O(on)}	-	0.1	0.3	V	I _O /I _I =5mA/0.25mA
Input Current	I _I	-	-	0.88	mA	V _I =5V
Output Current	I _{O(off)}	-	-	0.5	μA	V _{CC} =50V, V _I =0V
DC Current Gain	G _I	68	-	-	-	V _O =5V, I _O =5mA
Input Resistance	R _I	7	10	13	kΩ	-
Resistance Ratio	R ₂ /R ₁	3.7	4.7	5.7	-	-
Transition Frequency	f _T	-	250	-	MHz	V _{CE} =10V, I _C =5mA, f=100MHz *

* Transition frequency of the device

•Tr2(PNP)

Parameter	Symbol	Min.	Typ.	Max.	Unit	Test Conditions
Input Voltage	$V_{I(off)}$	-	-	-0.3	V	$V_{CC}=-5V, I_o=-100\mu A$
	$V_{I(on)}$	-1.4	-	-	V	$V_o=-0.3V, I_o=-1mA$
Output Voltage	$V_{O(on)}$	-	-	-0.3	V	$I_o/I_i=-5mA/-0.25mA$
Input Current	I_i	-	-	-0.88	mA	$V_i=-5V$
Output Current	$I_{O(off)}$	-	-	-0.5	μA	$V_{CC}=-50V, V_i=0V$
DC Current Gain	G_i	68	-	-	-	$V_o=-5V, I_o=-5mA$
Input Resistance	R_i	7	10	13	k Ω	-
Resistance Ratio	R_2/R_1	3.7	4.7	5.7	-	-
Transition Frequency	f_r	-	250	-	MHz	$V_{CE}=-10V, I_c=-5mA, f=100MHz$ *

* Transition frequency of the device

Recommended Soldering Footprint

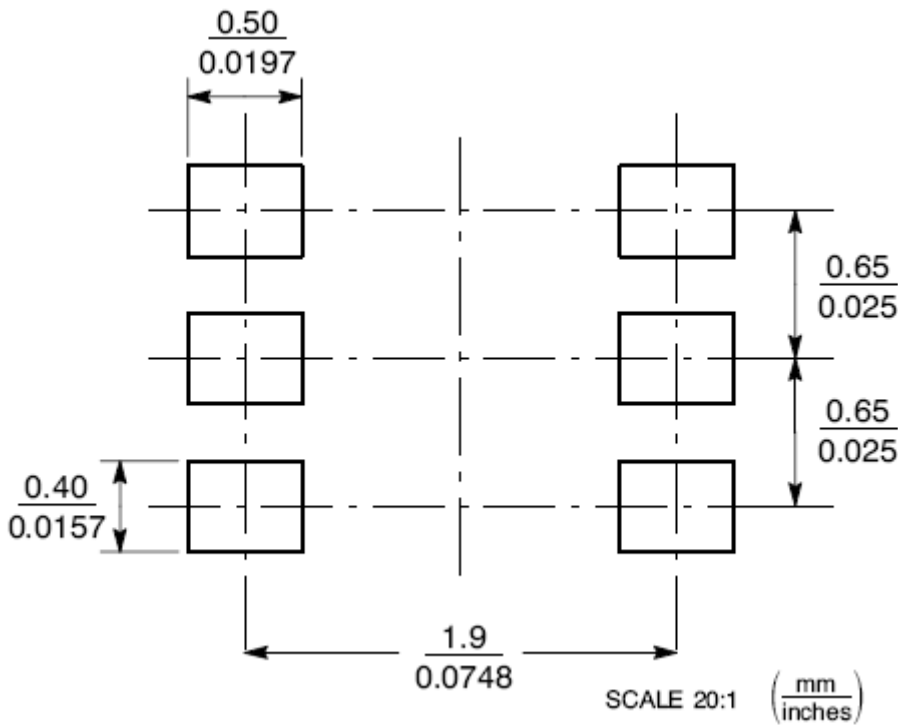



Typical Characteristics

•Tr1(NPN)

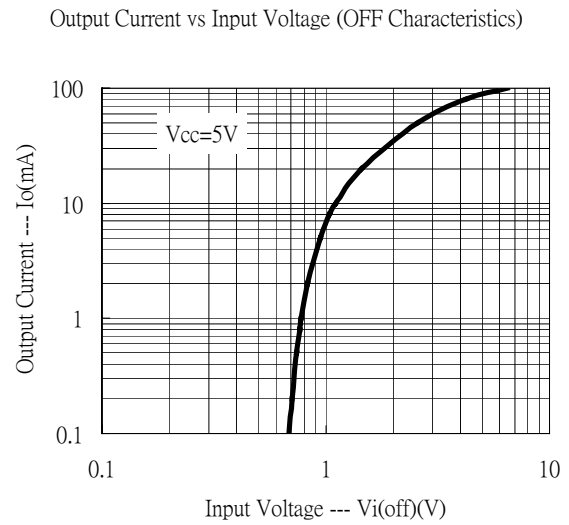
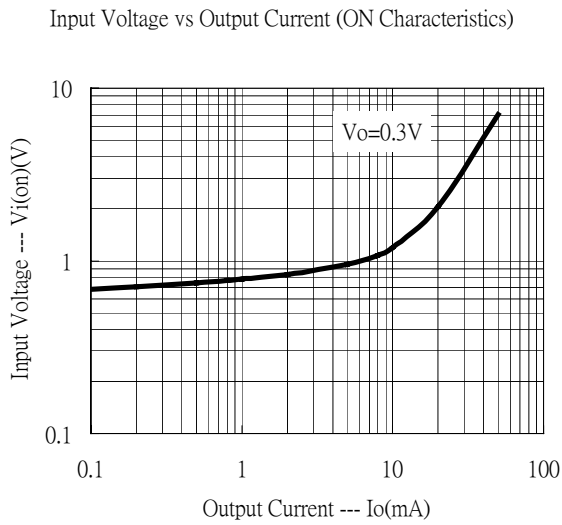
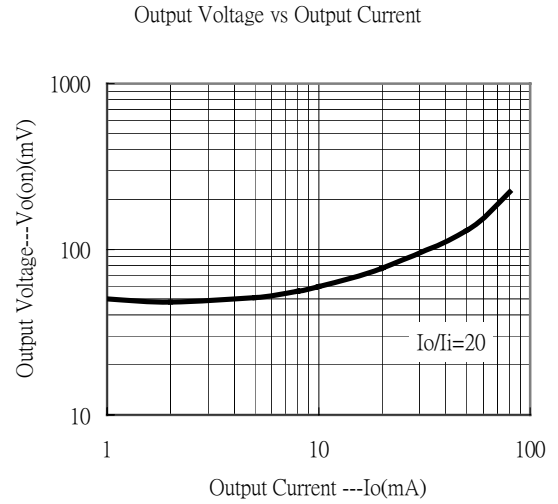
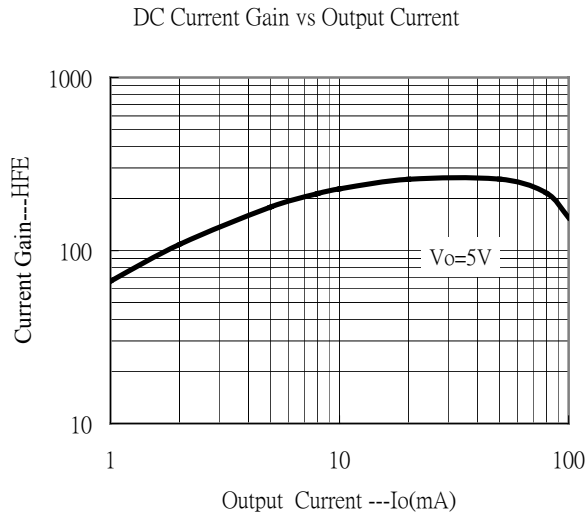

Typical Characteristics(Cont.)

•Tr2(PNP)

Current Gain vs Output Current

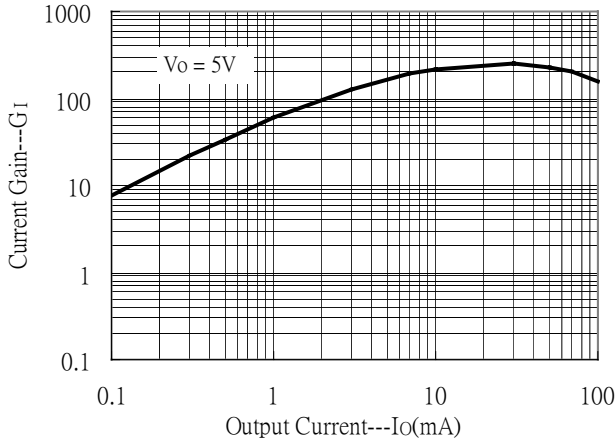

Output Voltage vs Output Current

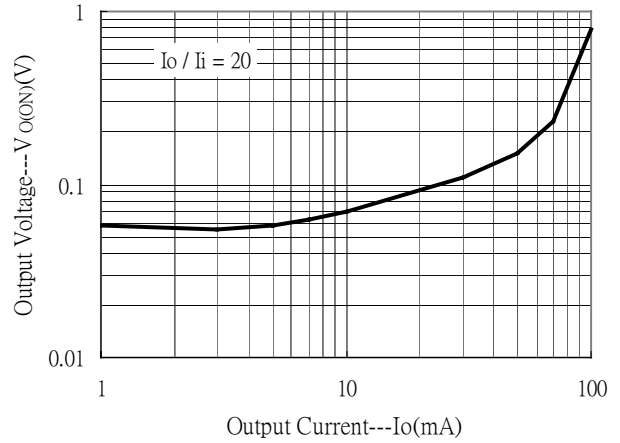

Input Voltage vs Output Current(ON characteristics)

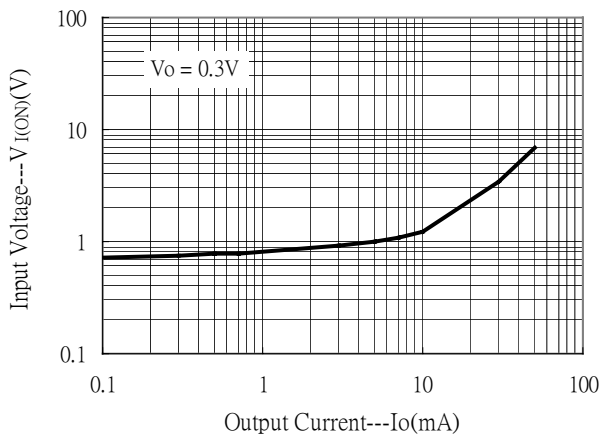

Output Current vs Input Voltage(OFF characteristics)

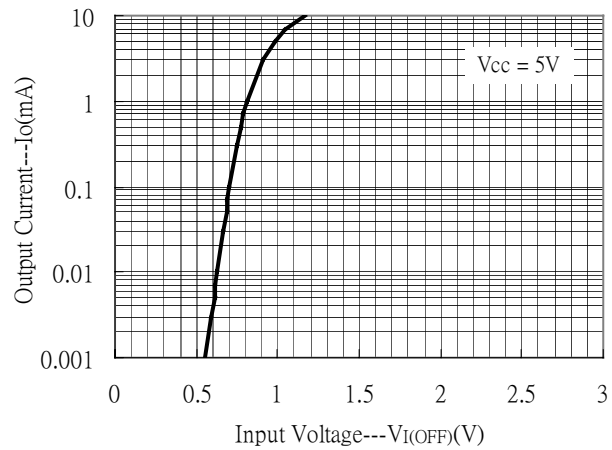

Power Derating Curve

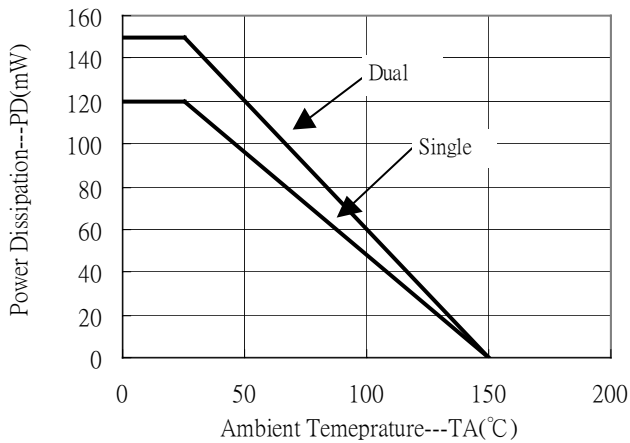

Reel Dimension

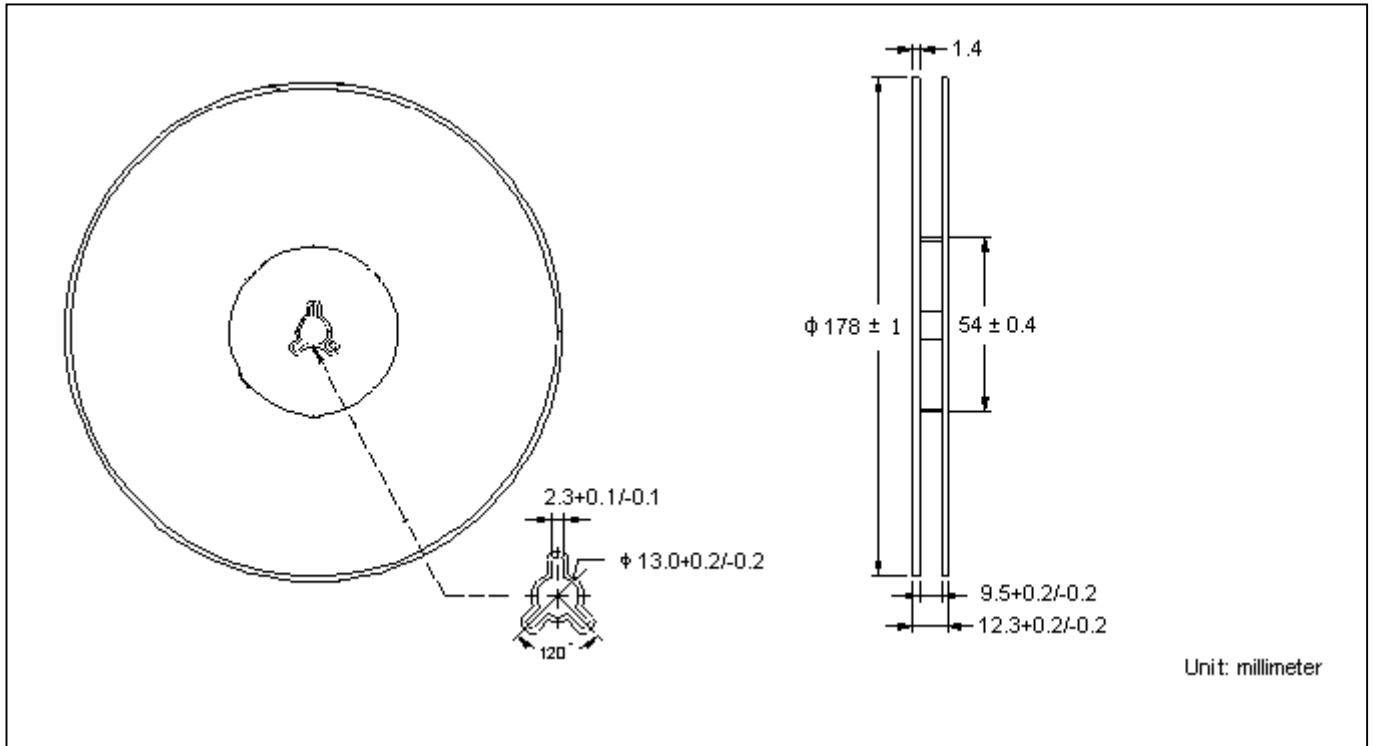

Carrier Tape Dimension

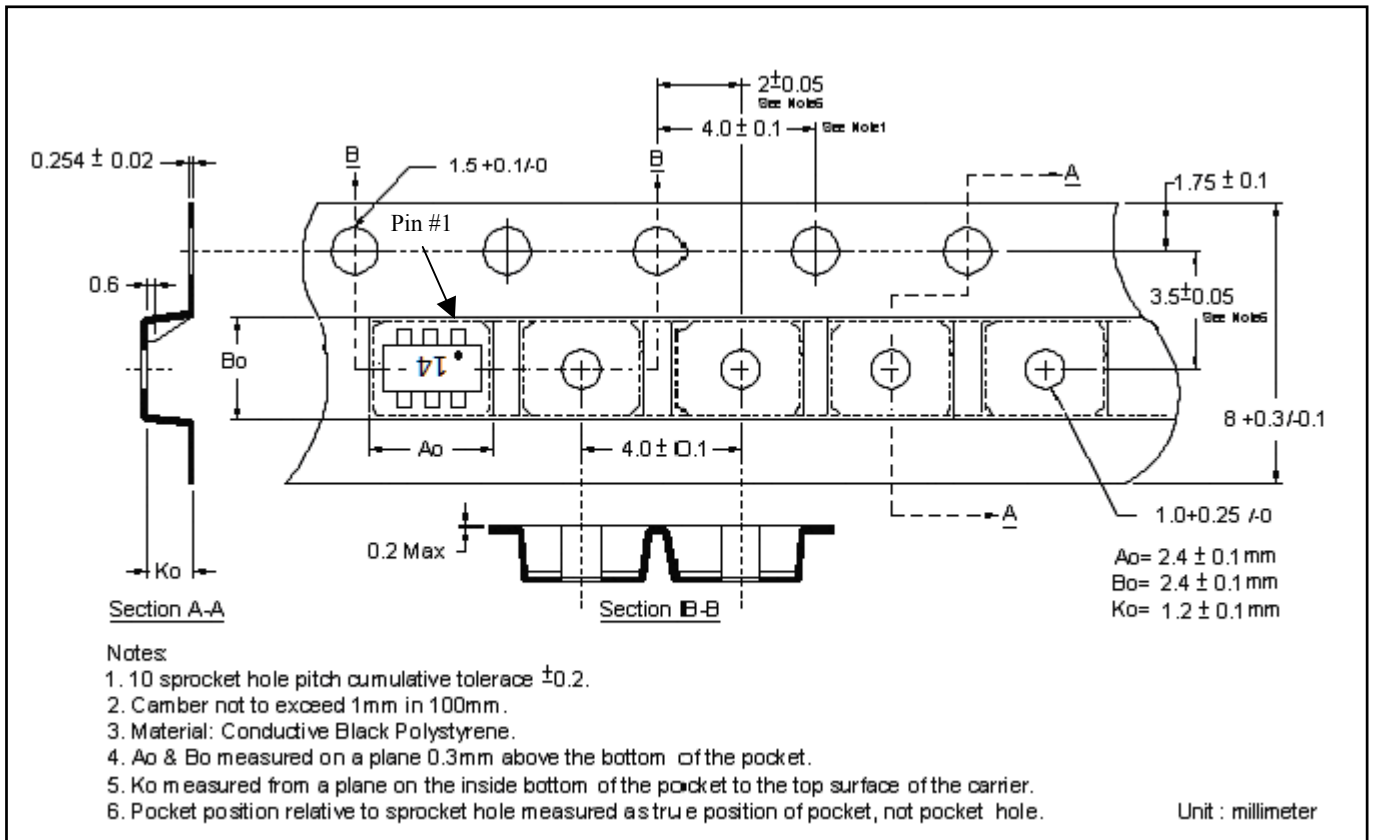

Recommended wave soldering condition

Product	Peak Temperature	Soldering Time
Pb-free devices	260 +0/-5 °C	5 +1/-1 seconds

Recommended temperature profile for IR reflow

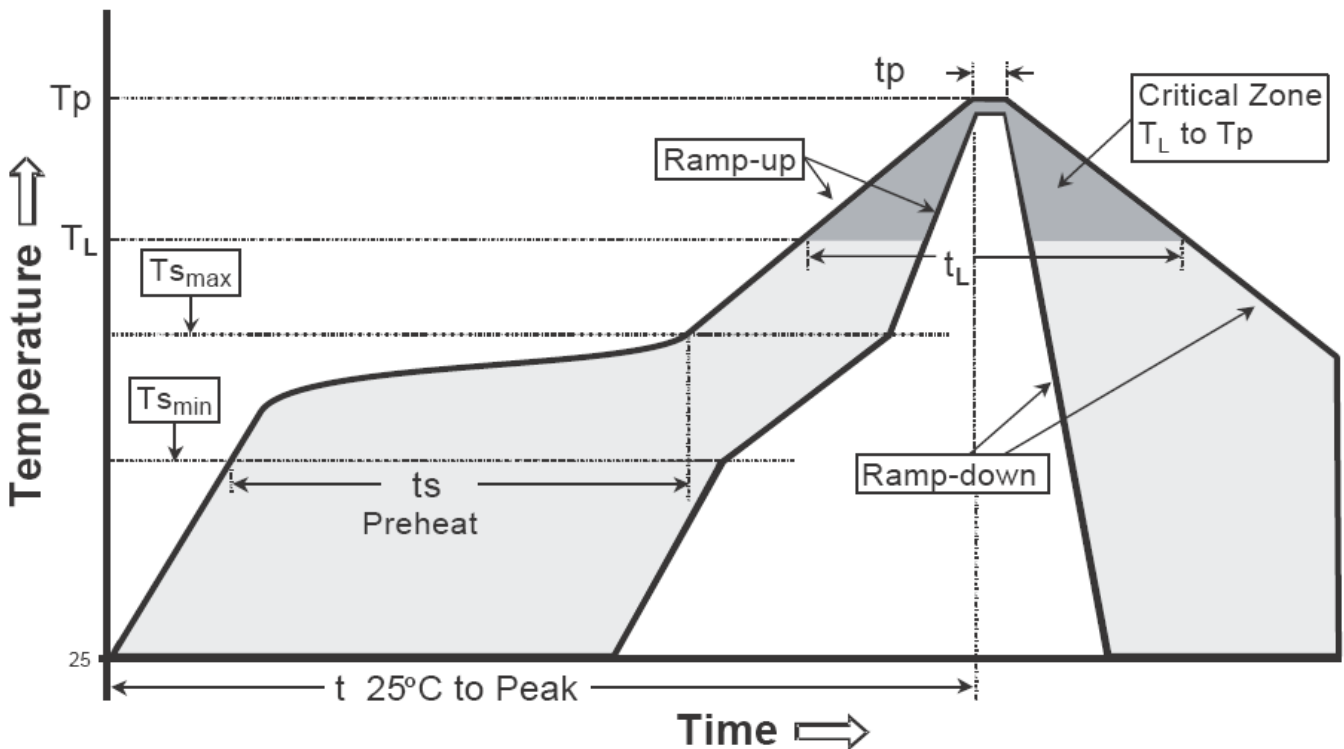

Profile feature	Sn-Pb eutectic Assembly	Pb-free Assembly
Average ramp-up rate (Tsmax to Tp)	3°C/second max.	3°C/second max.
Preheat		
-Temperature Min(T_s min)	100°C	150°C
-Temperature Max(T_s max)	150°C	200°C
-Time($t_{s\min}$ to $t_{s\max}$)	60-120 seconds	60-180 seconds
Time maintained above:		
-Temperature (T_L)	183°C	217°C
- Time (t_L)	60-150 seconds	60-150 seconds
Peak Temperature(T_p)	240 +0/-5 °C	260 +0/-5 °C
Time within 5°C of actual peak temperature(t_p)	10-30 seconds	20-40 seconds
Ramp down rate	6°C/second max.	6°C/second max.
Time 25 °C to peak temperature	6 minutes max.	8 minutes max.

Note : All temperatures refer to topside of the package, measured on the package body surface.

SOT-363 Dimension

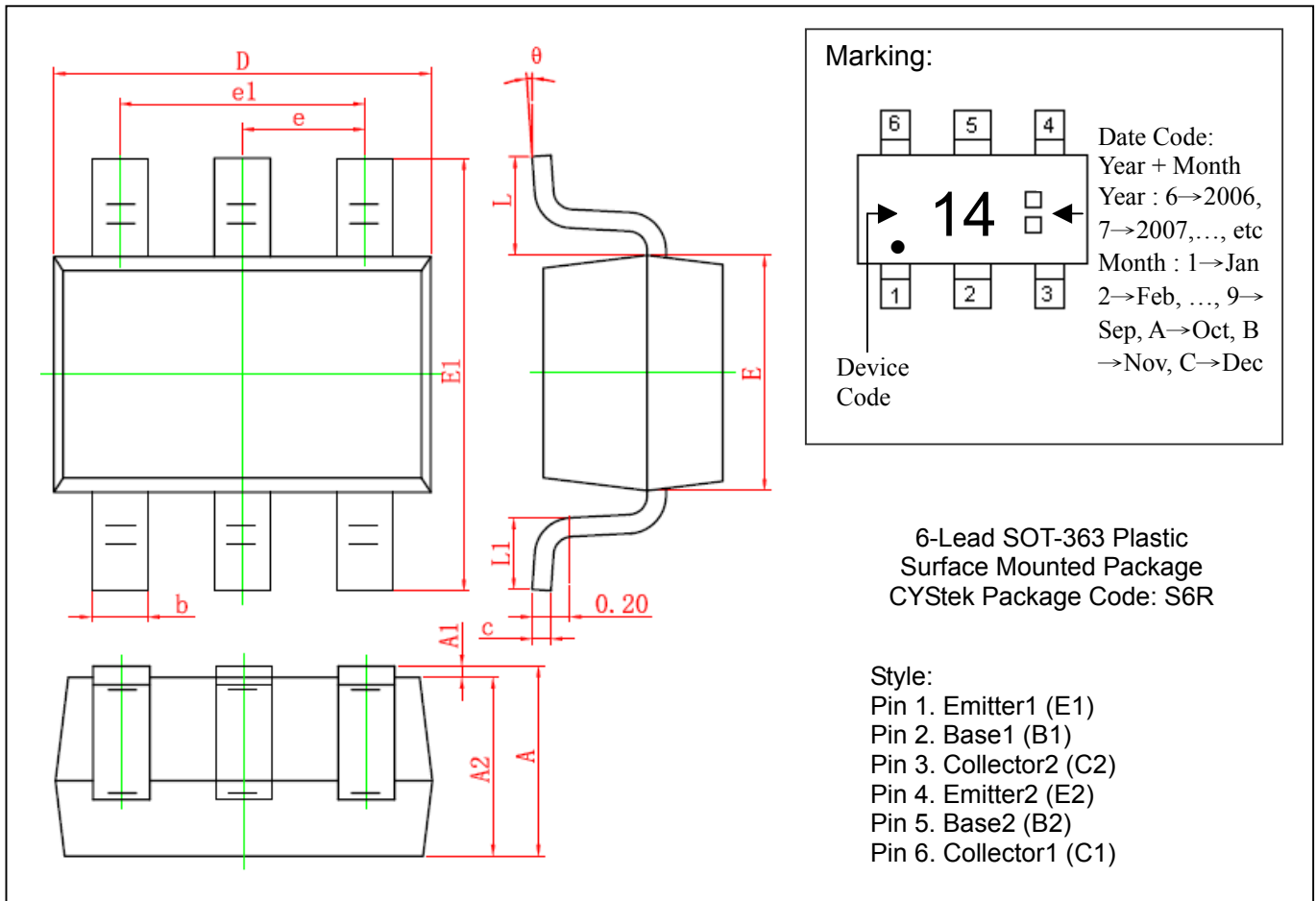

DIM	Millimeters		Inches		DIM	Millimeters		Inches	
	Min.	Max.	Min.	Max.		Min.	Max.	Min.	Max.
A	0.900	1.100	0.035	0.043	E1	2.150	2.450	0.085	0.096
A1	0.000	0.100	0.000	0.004	e	0.650	TYP	0.026	TYP
A2	0.900	1.000	0.035	0.039	e1	1.200	1.400	0.047	0.055
b	0.150	0.350	0.006	0.014	L	0.525	REF	0.021	REF
c	0.080	0.150	0.003	0.006	L1	0.260	0.460	0.010	0.018
D	2.000	2.200	0.079	0.087	θ	0°	8°	0°	8°
E	1.150	1.350	0.045	0.053					

Notes : 1.Controlling dimension : millimeters.
 2.Maximum lead thickness includes lead finish thickness, and minimum lead thickness is the minimum thickness of base material.
 3.If there is any question with packing specification or packing method, please contact your local CYStek sales office.

Material :

- Lead : Pure tin plated.
- Mold Compound : Epoxy resin family, flammability solid burning class:UL94V-0.

Important Notice:

- All rights are reserved. Reproduction in whole or in part is prohibited without the prior written approval of CYStek.
- CYStek reserves the right to make changes to its products without notice.
- CYStek **semiconductor products are not warranted to be suitable for use in Life-Support Applications, or systems.**
- CYStek assumes no liability for any consequence of customer product design, infringement of patents, or application assistance.