

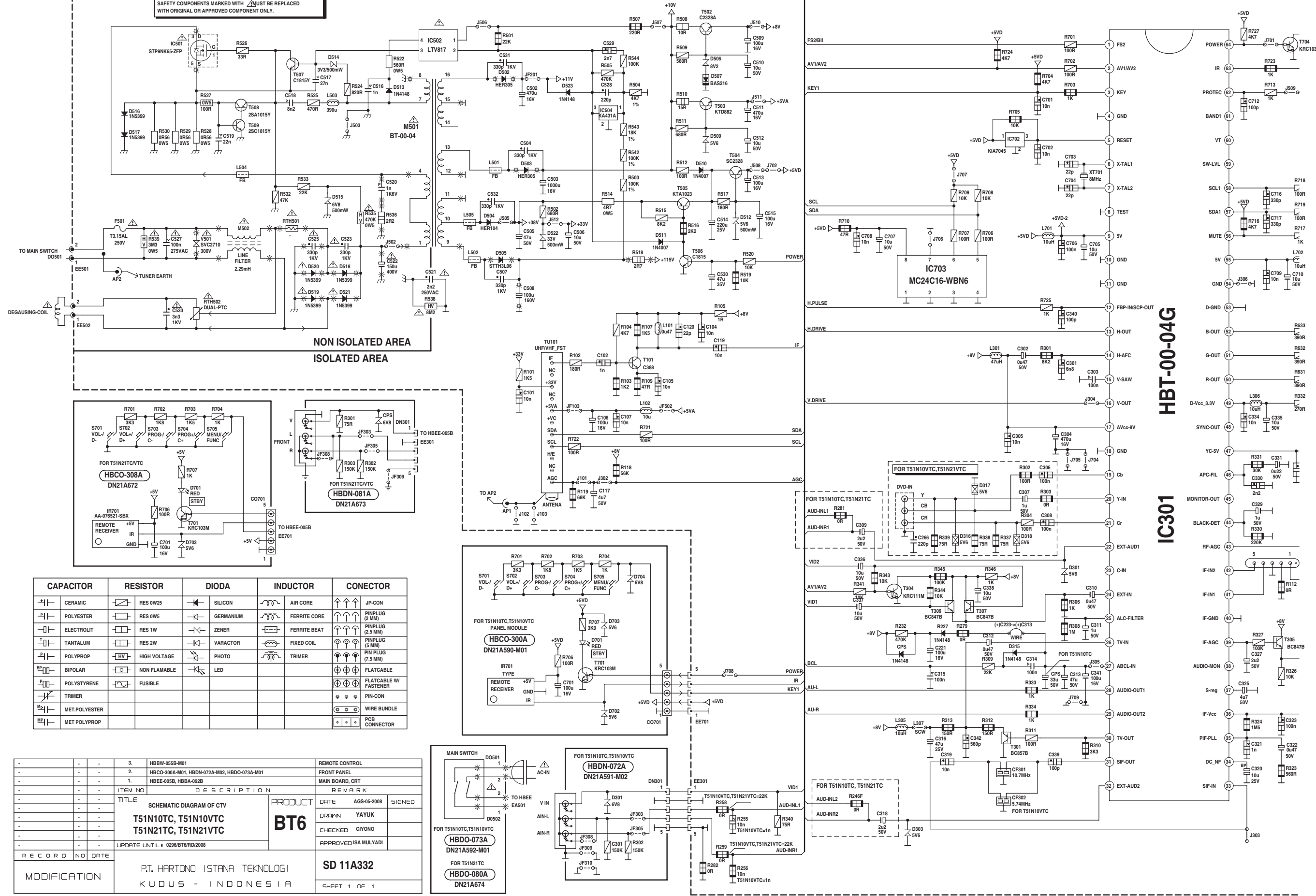



































WARNING!
SAFETY COMPONENTS MARKED WITH  MUST BE REPLACED WITH ORIGINAL OR APPROVED COMPONENT ONLY.



CAPACITOR	RESISTOR	DIODA	INDUCTOR	CONECTOR
				
CERAMIC	RES 0W25	SILICON	AIR CORE	JP-CON
				
POLYESTER	RES 0W5	GERMANIUM	FERRITE CORE	PINPLUG (2 MM)
				
ELECTROLIT	RES 1W	ZENER	FERRITE BEAD	PINPLUG (5 MM)
				
TANTALUM	RES 2W	VARACTOR	FIXED COIL	PINPLUG (7.5 MM)
				
POLYPROP	HIGH VOLTAGE	PHOTO	TRIMMER	FLATCABLE
				
BIPOLAR	NON FLAMABLE	LED		FLATCABLE W/ FASTENER
				
POLYSTYRENE	FUSIBLE			WIRE BUNDLE
				
TRIMMER				PCB CONNECTOR
				
MET POLYESTER				
				
MET POLYPROP				

3.	HBBW-055B-M01	REMOTE CONTROL
2.	HBCO-300A-M01, HBDN-072A-M02, HBD0-073A-M01	FRONT PANEL
1.	HBEE-005B, HBBA-092B	MAIN BOARD, CRT
ITEM NO	DESCRIPTION	REMARK
TITLE	SCHEMATIC DIAGRAM OF CTV	DATE
	T51N10TC, T51N10VTC	AGS-05-2008
	T51N21TC, T51N21VTC	SIGNED
		YAYUK
		GIYONO
		ISA MULYADI
UPDATE UNTIL	0296/BT6/RD/2008	APPROVED
RECORD NO	DATE	SD 11A332
MODIFICATION	P.T. HARTONO ISTANA TEKNOLOGI KUDUS - INDONESIA	SHEET 1 OF 1

HBT-00-04G

IC301

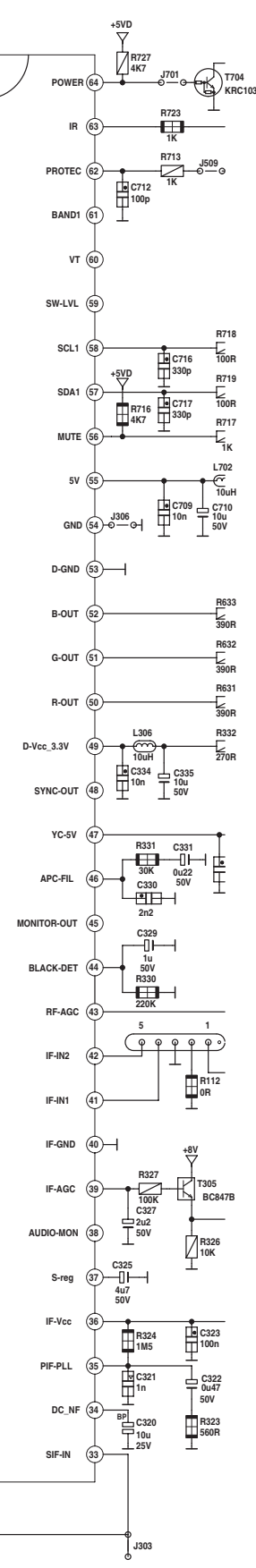

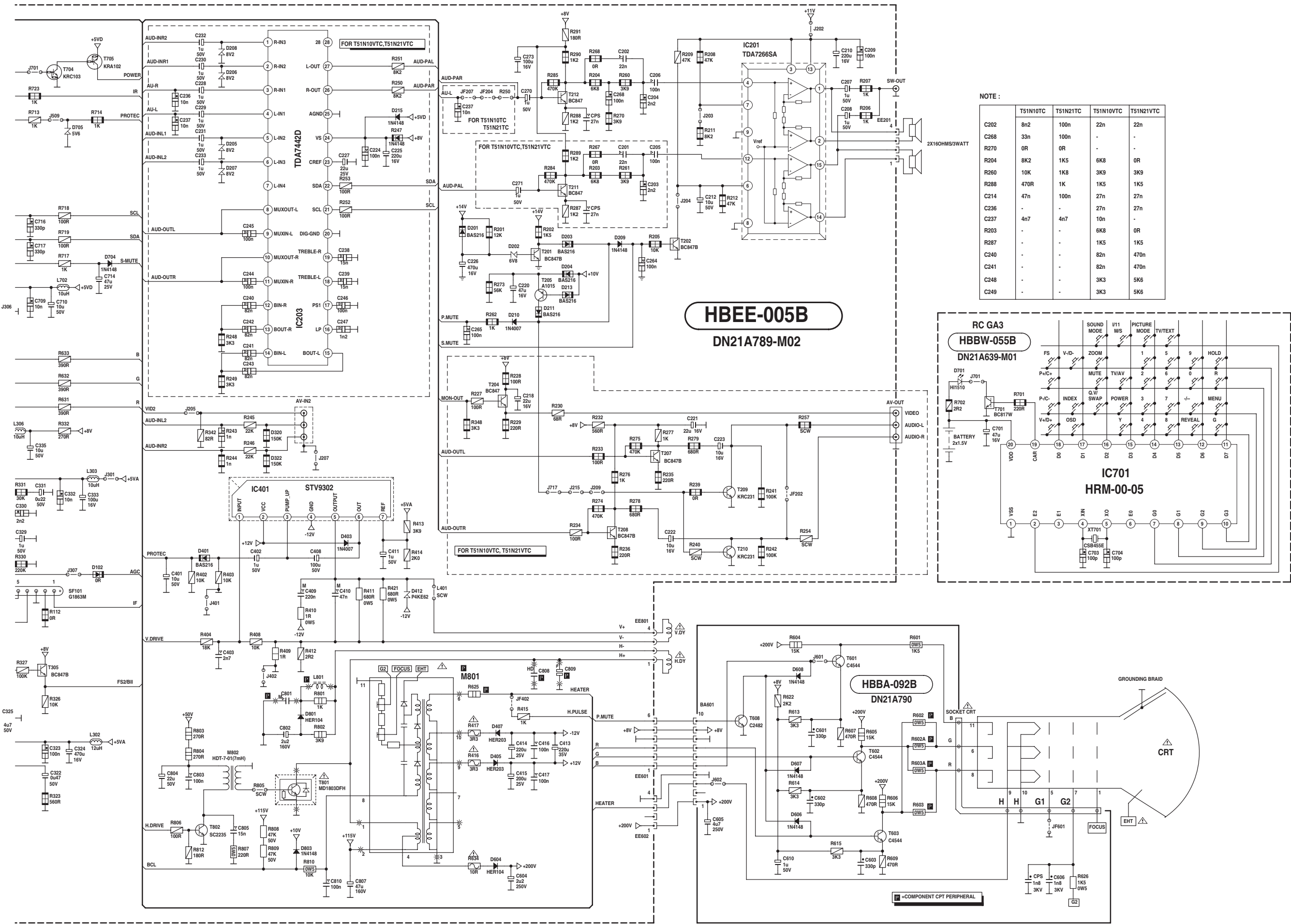

NOTE :

	T51N10TC	T51N21TC	T51N10VTC	T51N21VTC
C202	8n2	100n	22n	22n
C268	33n	100n	-	-
R270	0R	0R	-	-
R204	8K2	1K5	6K8	0R
R260	10K	1K8	3K9	3K9
R288	470R	1K	1K5	1K5
C214	47n	100n	27n	27n
C236	-	-	27n	27n
C237	4n7	4n7	10n	-
R203	-	-	6K8	0R
R287	-	-	1K5	1K5
C240	-	-	82n	470n
C241	-	-	82n	470n
C248	-	-	3K3	5K6
C249	-	-	3K3	5K6

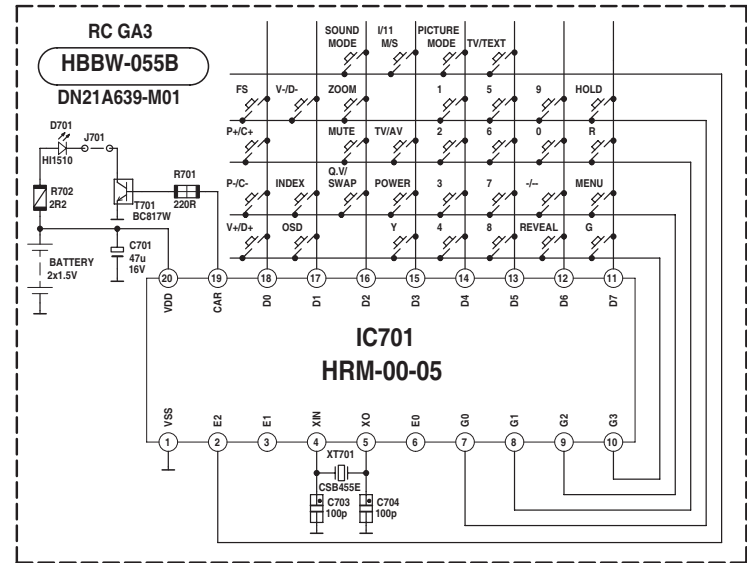

HBE-005B
DN21A789-M02

HBBW-055B
DN21A790

□ = COMPONENT CPT PERIPHERAL