

## Description

The HC3500P03 is a low profile, high performance 3dB hybrid coupler in a new easy to use, manufacturing friendly surface mount package. The HC3500P03 is particularly for balanced power and low noise amplifiers, plus signal designed distribution and other applications where low insertion loss and tight amplitude and phase balance is required. It can be used in power applications up to 25 Watts.

Parts have been subjected to rigorous qualification testing and they are manufactured using materials with coefficients of thermal expansion (CTE) compatible with common substrates such as FR4, G-10, RF-35, RO4350 and polyimide.

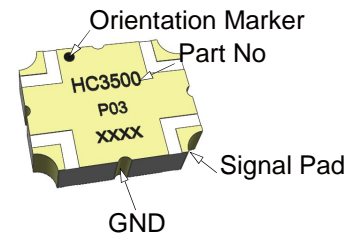

## Features:

- 3300-3800 MHz
- Low Insertion Loss
- Tight Amplitude Balance
- High Isolation
- Low VSWR
- Good Repeatability
- CTE compatible with FR4, G-10, RF-35, RO4350B and polyimide
- Immersion gold, prevent surface oxidation & scratch
- RoHS Compliant
- Tape & Reel Package available

## Electrical Specifications

Frequency	Isolation	Insertion Loss	VSWR	Amplitude Balance
<i>MHz</i>	<i>dB Min</i>	<i>dB Max</i>	<i>Max : 1</i>	<i>dB Max</i>
3300 - 3800	20	0.30	1.28	± 0.45
<b>Phase Balance</b>	<b>Power</b>	<b>Operating Temp.</b>		
<i>Degrees</i>	<i>Avg. CW Watts</i>	<i>°C</i>		
90 ± 4.0	25	-55 to +85		

### Notes:

1. All the above data are based on specified demo board.
2. Insertion loss: Thru board loss has been removed.

## Mechanical Outline

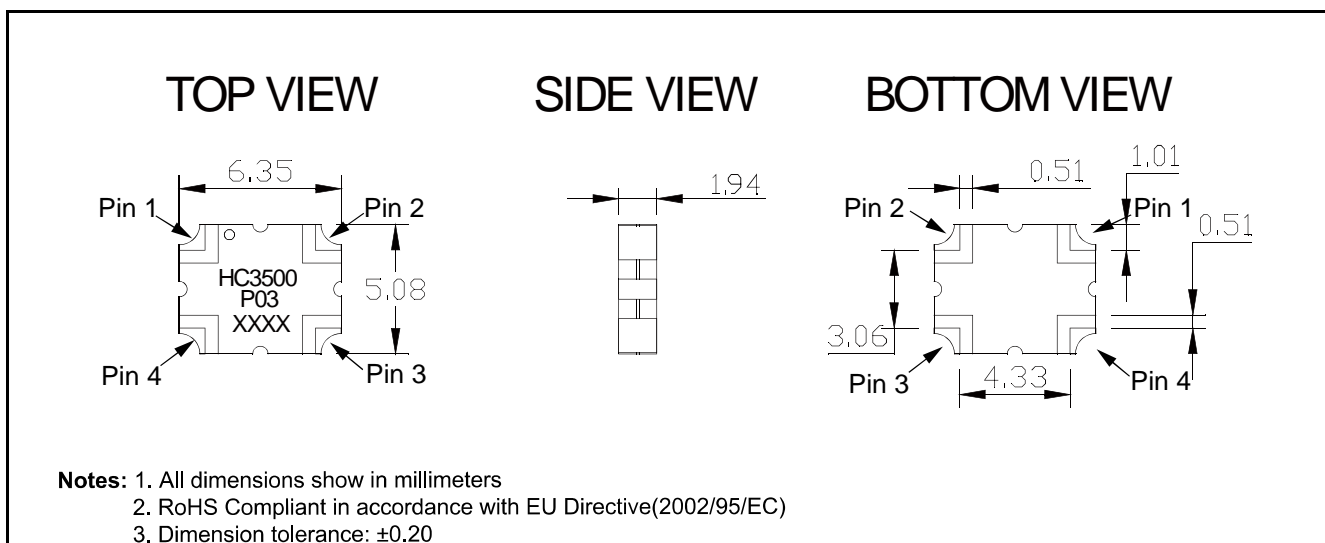

## Yantel Corporation

Add: Floor 2, Building 2, Gaofa Technology Park, Longjing, Nanshan, Shenzhen, China  
 Tel: 86-755-8355-1886 Fax: 86-755-8355-2533  
 For detailed performance specs & shopping online see Yantel web site : [www.yantel-corp.com](http://www.yantel-corp.com)

## Hybrid Coupler Pin Configuration

The HC3500P03 has an orientation marker to denote Pin 1. Once port one has been identified the other ports are known automatically. Please see the chart below for clarification:

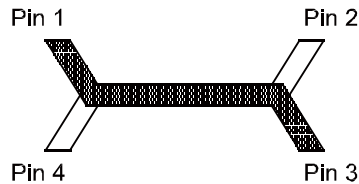

Configuration	Pin 1	Pin 2	Pin 3	Pin 4
Splitter	Input	Isolated	-3dB $\angle\theta - 90$	-3dB $\angle\theta$
Splitter	Isolated	Input	-3dB $\angle\theta$	-3dB $\angle\theta - 90$
Splitter	-3dB $\angle\theta - 90$	-3dB $\angle\theta$	Input	Isolated
Splitter	-3dB $\angle\theta$	-3dB $\angle\theta - 90$	Isolated	Input
*Combiner	A $\angle\theta - 90$	A $\angle\theta$	Isolated	Output
*Combiner	A $\angle\theta$	A $\angle\theta - 90$	Output	Isolated
*Combiner	Isolated	Output	A $\angle\theta - 90$	A $\angle\theta$
*Combiner	Output	Isolated	A $\angle\theta$	A $\angle\theta - 90$

\*Note: "A" is the amplitude of the applied signals. When two quadrature signals with equal amplitudes are applied to the coupler as described in the table, they will combine at the output port. If the amplitudes are not equal, some of the applied energy will be directed to the isolated port.

## Typical Performance Data (@25°C)

Frequency (MHz)	Coupling (dB)	Transmission (dB)	Insertion Loss (dB)	Isolation (dB)	Amplitude Balance (dB)	Phase (degree)	Return Loss(dB)			
							S11	S22	S33	S44
3300	-3.02	-3.03	-0.01	-51.10	0.01	88.42	-29.37	-31.23	-33.20	-31.81
3325	-3.01	-3.14	-0.06	-52.68	0.13	88.29	-27.57	-30.72	-31.72	-32.61
3350	-3.05	-3.17	-0.10	-47.23	0.12	88.00	-26.92	-30.99	-31.13	-32.43
3375	-3.04	-3.13	-0.07	-42.50	0.09	88.00	-26.26	-31.57	-30.58	-32.68
3400	-3.03	-3.18	-0.09	-41.44	0.15	88.25	-26.02	-31.42	-29.58	-32.40
3425	-3.01	-3.23	-0.11	-38.29	0.22	88.00	-25.50	-31.27	-28.04	-32.12
3450	-3.03	-3.25	-0.13	-37.02	0.22	87.95	-24.82	-30.60	-27.12	-31.87
3475	-2.94	-3.19	-0.05	-35.25	0.25	88.19	-24.43	-30.62	-26.74	-32.09
3500	-2.88	-3.17	-0.01	-33.80	0.29	87.92	-23.87	-30.70	-26.02	-31.93
3525	-2.91	-3.19	-0.04	-32.37	0.28	87.76	-23.20	-30.16	-25.01	-31.05
3550	-3.00	-3.32	-0.15	-31.18	0.32	87.82	-22.76	-29.01	-24.47	-31.08
3575	-3.01	-3.37	-0.18	-30.16	0.36	87.66	-22.40	-28.13	-23.86	-30.72
3600	-2.98	-3.28	-0.12	-29.17	0.30	87.68	-22.27	-27.89	-23.19	-29.84
3625	-3.00	-3.35	-0.16	-28.40	0.35	87.89	-21.70	-27.43	-22.32	-29.32
3650	-3.00	-3.40	-0.19	-27.75	0.40	87.38	-21.29	-26.67	-21.97	-28.94
3675	-2.99	-3.35	-0.16	-26.93	0.36	87.07	-20.97	-25.76	-21.77	-28.93
3700	-2.95	-3.32	-0.12	-26.26	0.37	87.42	-20.86	-25.20	-21.36	-28.29
3725	-3.01	-3.42	-0.20	-25.71	0.41	87.39	-20.41	-24.63	-20.92	-27.61
3750	-3.00	-3.39	-0.18	-25.04	0.39	86.90	-20.03	-23.95	-20.65	-27.05
3775	-2.99	-3.32	-0.14	-24.39	0.33	87.04	-19.84	-23.23	-20.38	-26.54
3800	-3.00	-3.36	-0.17	-23.95	0.36	87.13	-19.53	-22.69	-19.92	-26.20

## Yantel Corporation

Add: Floor 2, Building 2, Gaofa Technology Park, Longjing, Nanshan, Shenzhen, China

Tel: 86-755-8355-1886 Fax: 86-755-8355-2533

For detailed performance specs & shopping online see Yantel web site : [www.yantel-corp.com](http://www.yantel-corp.com)

**Typical Performance (-55°C,25°C,85°C: 3300-3800 MHz)**

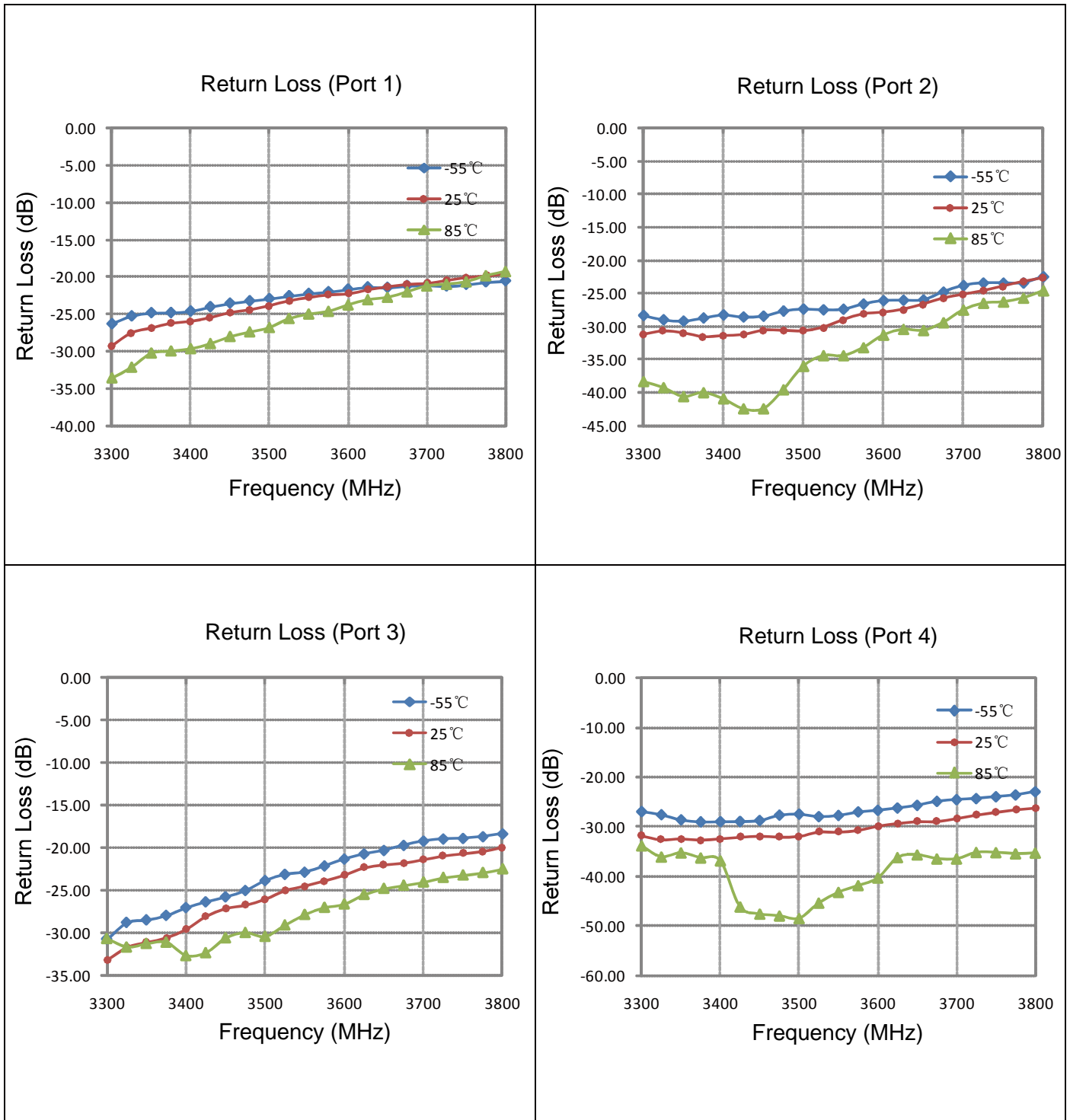

**Yantel Corporation**

**Typical Performance (-55°C,25°C,85°C: 2300-2800 MHz)**

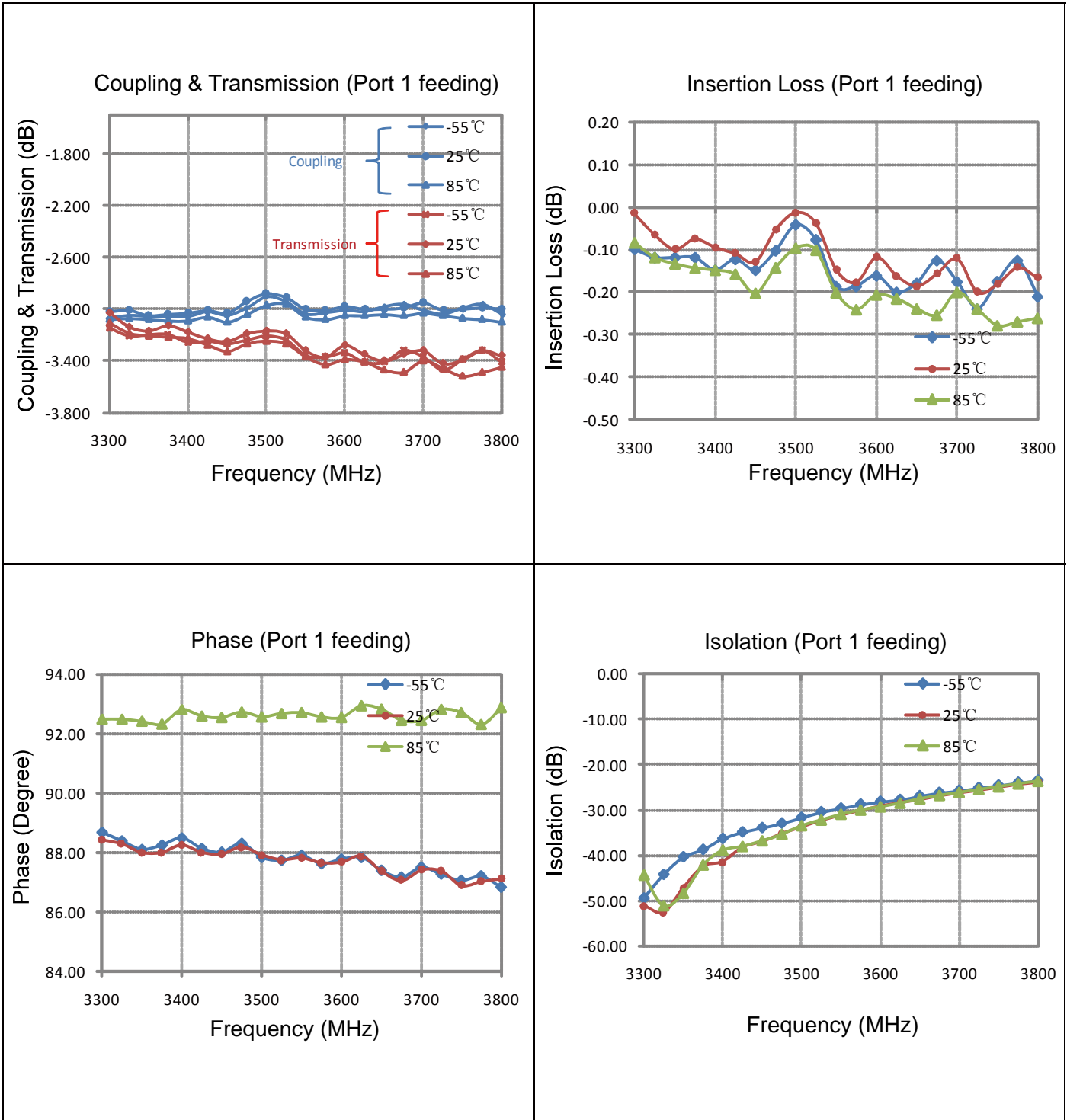

**Yantel Corporation**

### Definition of Measured Specifications

Parameter	Definition	Mathematical Representation
<b>VSWR</b> (Voltage Standing Wave Ratio)	The impedance match of the coupler to a 50Ω system. A VSWR of 1:1 is optimal.	$VSWR = \frac{V_{max}}{V_{min}}$ Vmax = voltage maxima of a standing wave Vmin = voltage minima of a standing wave
<b>Return Loss</b>	The impedance match of the coupler to a 50Ω system. Return Loss is an alternate means to express VSWR.	$\text{Return Loss (dB)} = 20 \log \frac{VSWR + 1}{VSWR - 1}$
<b>Insertion Loss</b>	The input power divided by the sum of the power at the two output ports.	$\text{Insertion Loss (dB)} = 10 \log \frac{P_{in}}{P_{cpl} + P_{transmission}}$
<b>Isolation</b>	The input power divided by the power at the isolated port.	$\text{Isolation (dB)} = 10 \log \frac{P_{in}}{P_{iso}}$
<b>Phase Balance</b>	The difference in phase angle between the two output ports.	Phase at coupled port – Phase at transmission port
<b>Amplitude Balance</b>	The power at each output divided by the average power of the two outputs.	$10 \log \left( \frac{P_{cpl}}{P_{cpl} + P_{transmission}} \right) \text{ and } 10 \log \left( \frac{P_{transmission}}{P_{cpl} + P_{transmission}} \right)$

### Test Method

1. Calibrating your vector network analyzer.
2. Connect the VNA 4 Port to DUT respectively.
3. Measure the data of coupling through port 1 to port 4(S41).
4. Measure the data of transmission through port 1 to port 3(S31).
5. Measure the data of isolation through port 1 to port 2(S21).
6. Measure the data of phase port 4 & port 3(port 1 feeding).
7. Measure the data of return loss port 1, port 2, port 3 & port 4.
8. According to the above data to calculate insertion loss, amplitude balance & phase.

### Note:

1. When calculating insertion loss at room temperature, demo board loss should be removed from both coupling & transmission data.

Please refer to the below table for demo board loss :

Frequency Range(MHz)	Demo Board Loss (dB) @25°C
<b>470-860</b>	0.07
<b>800-1000</b>	0.10
<b>1200-1700</b>	0.15
<b>1700-2000</b>	0.15
<b>2000-2300</b>	0.20
<b>2300-2700</b>	0.25

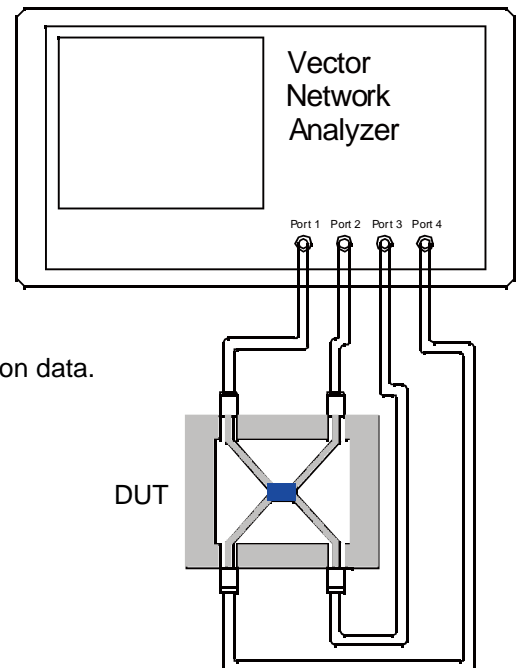

### Yantel Corporation

## Recommended PCB Layout

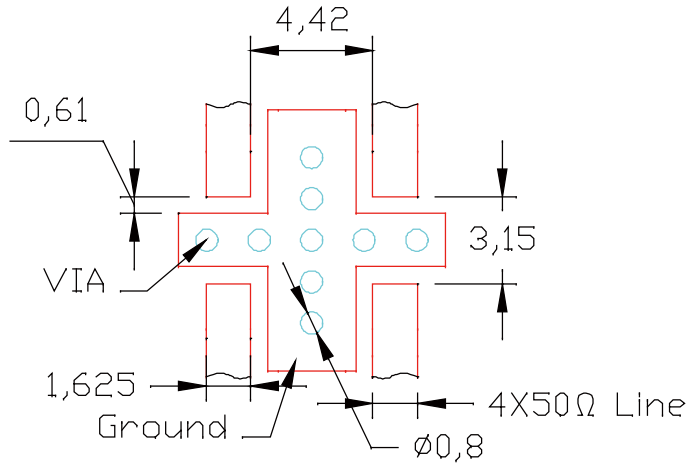

### NOTE:

1. 50Ω line width is shown above designing from RO4350B dielectric thickness 0.762mm; copper 1 OZ
2. Bottom side of the PCB is continuous ground plane.
3. All dimensions shown in mm.

## Reflow Profile

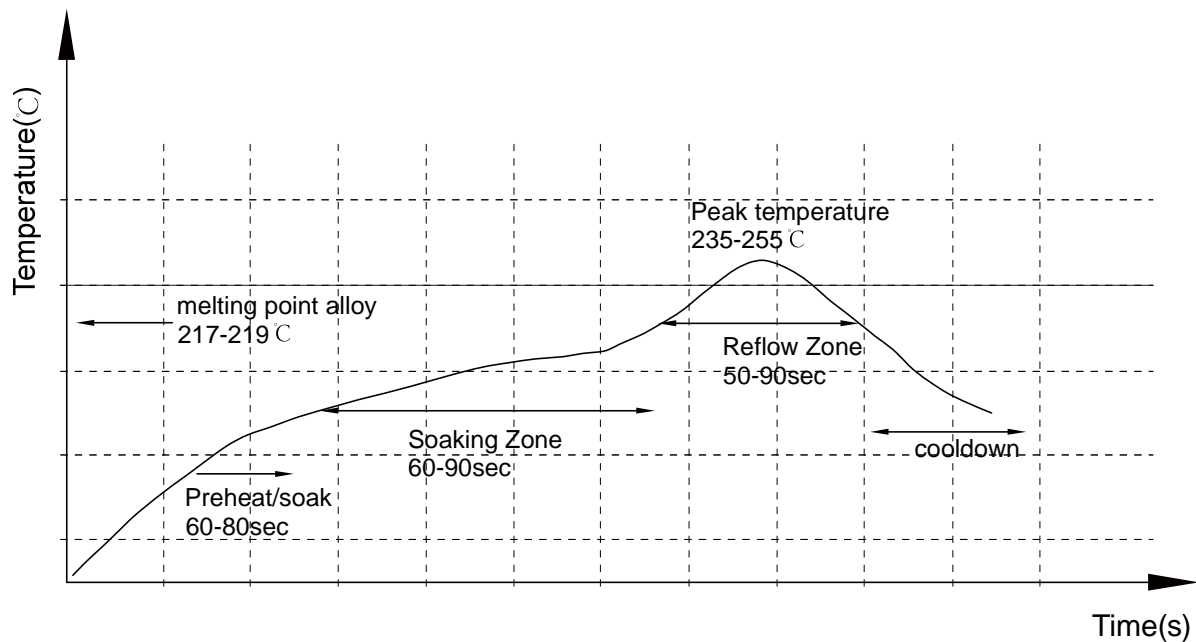

## Yantel Corporation

Add: Floor 2, Building 2, Gaofa Technology Park, Longjing, Nanshan, Shenzhen, China  
 Tel: 86-755-8355-1886 Fax: 86-755-8355-2533  
 For detailed performance specs & shopping online see Yantel web site : [www.yantel-corp.com](http://www.yantel-corp.com)

## Reliability Test Flow

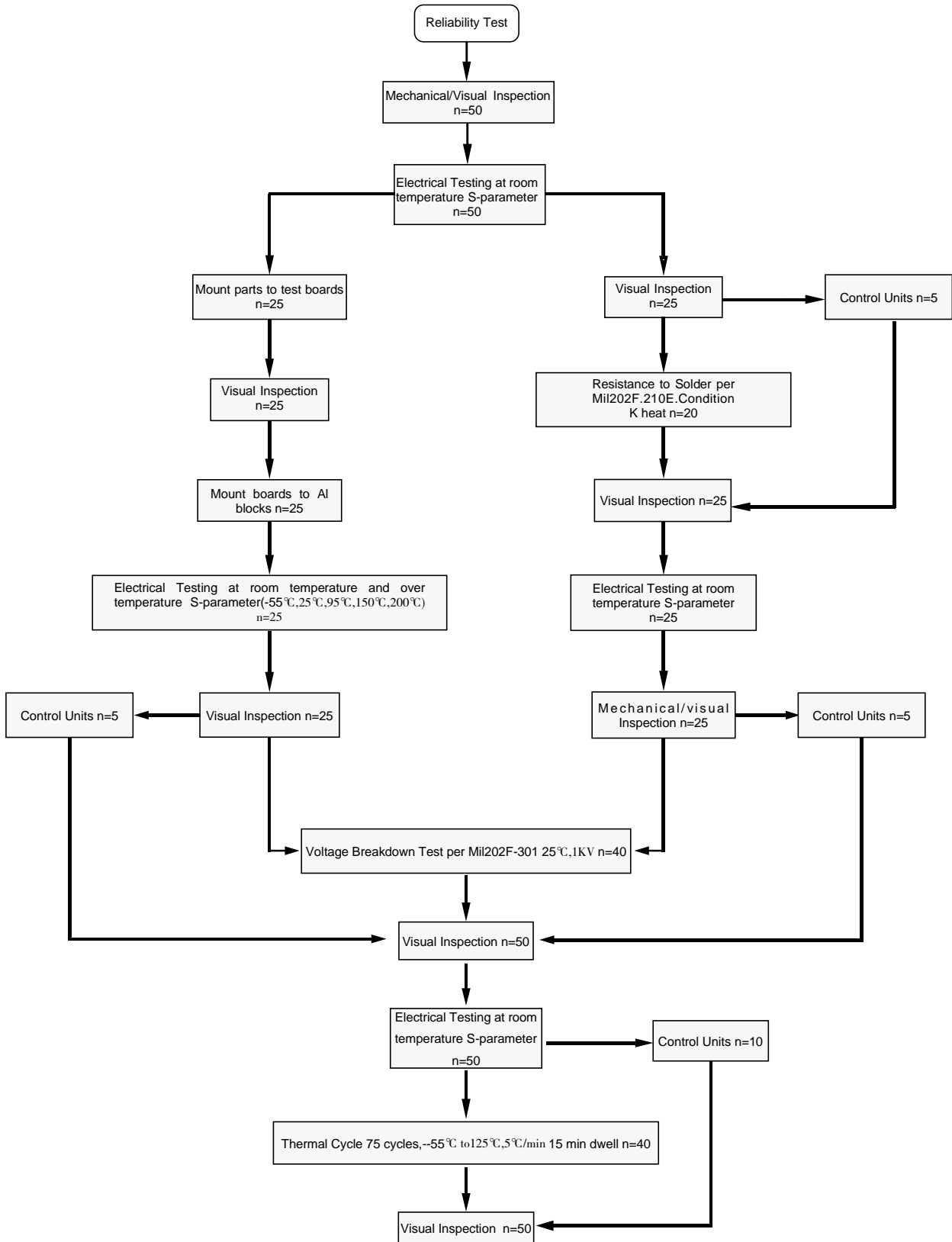

### Yantel Corporation

## Reliability Test Flow

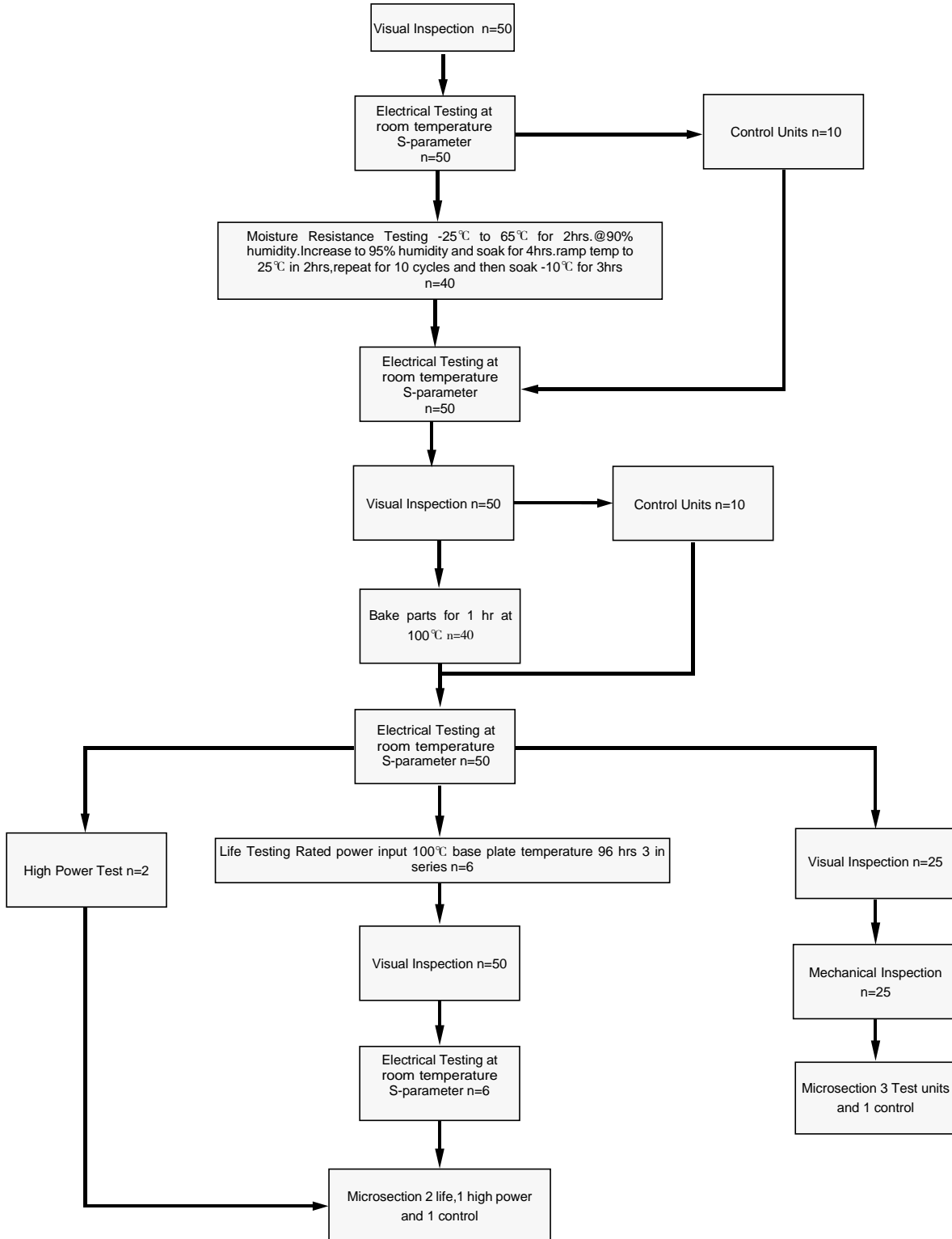



### Tape and Reel Drawing

Feeding Direction  
→

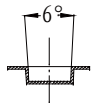
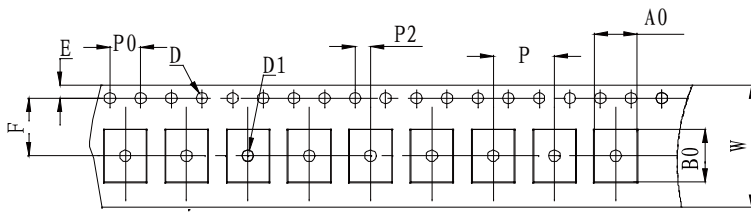

SECTION A-A

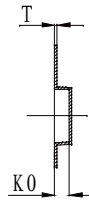

SECTION B-B

Notice:

- A. 10 Sprocket hole pitch cumulative tolerance is 0.2mm.
- B. Carrier camber shall be not more than 1mm per 100mm through a length of 250mm.
- C. All dimensions meet EIA-418-B requirements.
- D. A0 & B0 measured as indicated.
- E. K0 measured from a place on the inside bottom of the pocket to top surface of carrier.
- F. Material: PE 100
- G. Thickness: 0.30±0.05mm
- H. 4000 units (maximum) / T&R

ITEM	W	A0	B0	K0	P	F	E	D	D1	P0	P2	T	13"	
DIM(mm)	16.0	5.50	6.80	2.30	8.00	7.50	1.75	1.50	1.50	4.00	2.00	0.30	M/R	P/R
TOLE	+0.30 -0.30	+0.10 -0.10	+0.10 -0.10	+0.10 -0.10	+0.10 -0.10	+0.10 -0.10	+0.10 -0.10	+0.10 -0.00	+0.10 -0.00	+0.10 -0.10	+0.10 -0.10	+0.05 -0.05	32.8MR	4000pcs

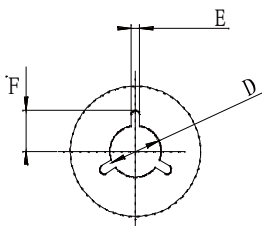

DETAIL 2:1

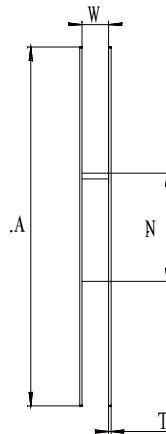
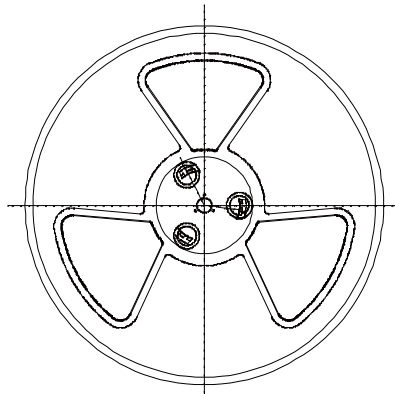

Symbol	Dimensions(mm)
W	16.5±0.4
A	330±0.5
N	100±0.3
T	1.8±0.3
E	2.1±0.2
F	10.75±0.3
D	13.5+0.5/-0.2

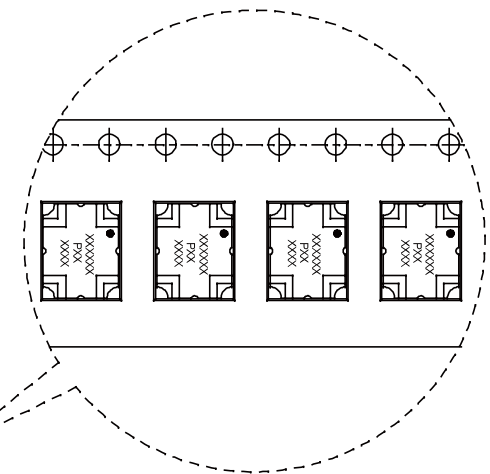
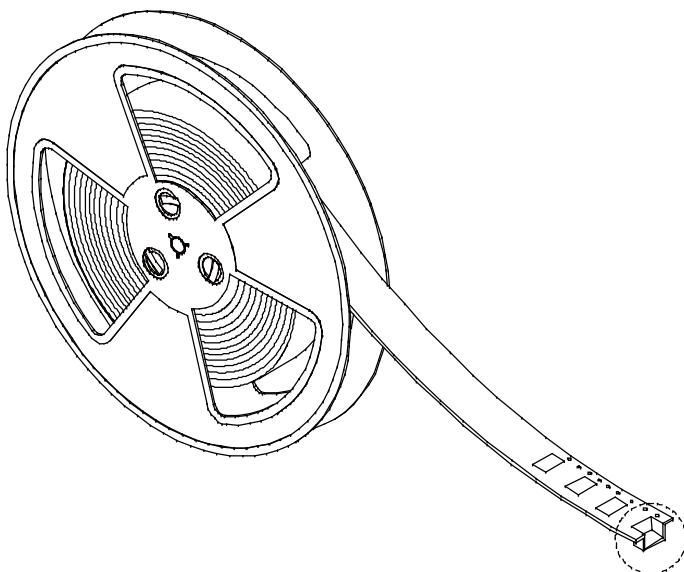

### Yantel Corporation

Add: Floor 2, Building 2, Gaofa Technology Park, Longjing, Nanshan, Shenzhen, China  
 Tel: 86-755-8355-1886 Fax: 86-755-8355-2533  
 For detailed performance specs & shopping online see Yantel web site : [www.yantel-corp.com](http://www.yantel-corp.com)