

Power Bipolar Transistor Base Drive Optocoupler

Technical Data

HCPL-3000

Features

- **High Output Current**
 I_{O2} (2.0 A Peak, 0.6 A Continuous)
 I_{O1} (1.0 A Peak, 0.5 A Continuous)
- **1.5 kV/ μ s Minimum Common Mode Rejection (CMR) at $V_{CM} = 600$ V**
- **Wide V_{CC} Range (5.4 to 13 Volts)**
- **2 μ s Typical Propagation Delay**
- **Recognized under UL 1577 for Dielectric Withstand Proof Test Voltage of 5000 Vac, 1 Minute**

Applications

- **Isolated Bipolar Transistor Base Drive**
- **AC and DC Motor Drives**
- **General Purpose Industrial Inverters**
- **Uninterruptable Power Supply**

Description

The HCPL-3000 consists of a Silicon-doped GaAs LED optically coupled to an integrated circuit with a power output stage. This optocoupler is suited for driving power bipolar transistors and power Darlington devices used in motor control inverter applications. The high peak and steady state current capabilities of the output stage allow for direct interfacing to the power device without the need for an intermediate amplifier stage. With a CMR

rating of 1.5 kV/ μ s this optocoupler readily rejects transients found in inverter applications.

The LED controls the state of the output stage. Transistor Q2 in the output stage is on with the LED off, allowing the base of the power device to be held low. Turning on the LED turns off transistor Q2 and switches on transistor Q1 in the output stage which provides current to drive the base of a power bipolar device.

Functional Diagram

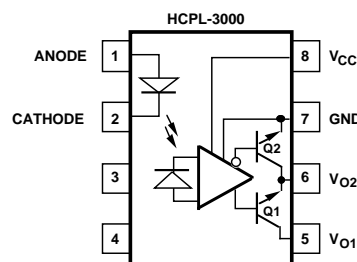

TRUTH TABLE

LED	OUTPUT	Q1	Q2
ON	HIGH LEVEL	ON	OFF
OFF	LOW LEVEL	OFF	ON

THE USE OF A 0.1 μ F BYPASS CAPACITOR CONNECTED BETWEEN PINS 8 AND 7 IS RECOMMENDED. ALSO, CURRENT LIMITING RESISTORS ARE RECOMMENDED (SEE FIGURE 1, NOTE 2, AND NOTE 7).

CAUTION: It is advised that normal static precautions be taken in handling and assembly of this component to prevent damage and/or degradation which may be induced by ESD.

Schematic

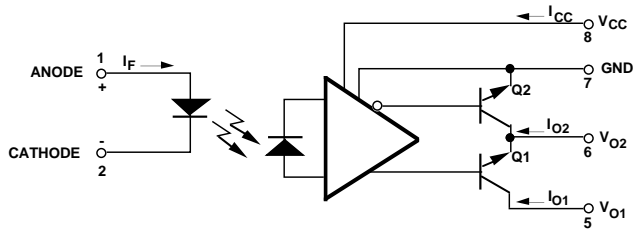

Outline Drawing

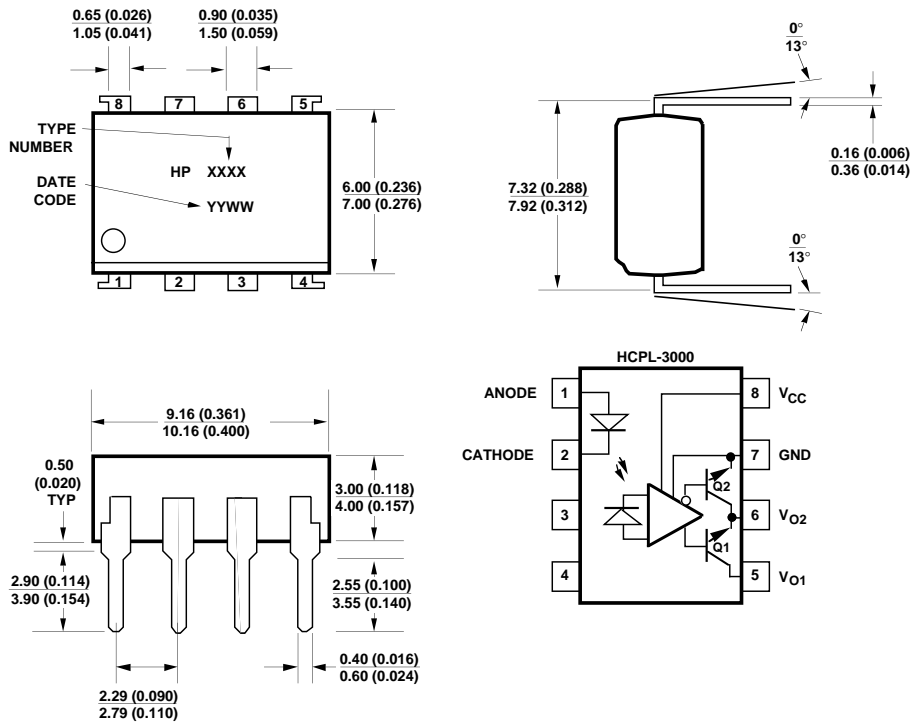

Regulatory Information

The HCPL-3000 has been approved by the following organizations:

UL

Recognized under UL 1577, Component Recognition Program, File E55361.

Demonstrated ESD Performance

Human Body Model: MIL-STD-883 Method 3015.7: Class 2

Machine Model: EIAJ IC-121-1988 (1988.3.28 Version 2), Test Method 20, Condition C: 1200 V

Insulation and Safety Related Specifications

Parameter	Symbol	Value	Units	Conditions
Min. External Air Gap (External Clearance)	L(IO1)	6.0	mm	Shortest distance measured through air, between two conductive leads, input to output
Min. External Tracking Path (External Creepage)	L(IO2)	6.0	mm	Shortest distance path measured along outside surface of optocoupler body between the input and output leads
Min. Internal Plastic Gap (Internal Clearance)		0.15	mm	Through insulation distance conductor to conductor inside the optocoupler cavity

Absolute Maximum Ratings

Parameter	Symbol	Min.	Max.	Unit	Conditions	Fig.	Note	
Storage Temperature	T_S	-55	125	°C				
Operating Temperature	T_A	-20	80	°C				
Input	Continuous Current	I_F		25	mA	9	1	
	Reverse Voltage	V_R		6	V	$T_A = 25^\circ\text{C}$		
Supply Voltage	V_{CC}		18	V				
Output 1	Continuous Current	I_{O1}		0.5	A	10, 11	1	
	Peak Current			1.0	A	Pulse Width < 5 μs , Duty cycle = 1%	1	
	Voltage	V_{O1}		18	V			
Output 2	Continuous Current	I_{O2}		0.6	A	10, 11, 12	1	
	Peak Current			2.0	A	Pulse Width < 5 μs , Duty cycle = 1%	12	1
Output Power Dissipation	P_O		500	mW		10	1	
Total Power Dissipation	P_T		550	mW		11	1	
Lead Solder Temperature	260°C for 10 s, 1.0 mm below seating plane							

Recommended Operating Conditions

Parameter	Symbol	Min.	Max.	Units
Power Supply Voltage	V_{CC}	5.4	13	V
Input Current (ON)	$I_{F(ON)}$	8*	20	mA
Input Current (OFF)	$I_{F(OFF)}$	-	0.2	mA
Operating Temperature	T_A	-20	80	°C

*The initial switching threshold is 5 mA or less.

Recommended Protection for Output Transistors

During switching transitions, the output transistors Q1 and Q2 of the HCPL-3000 can conduct large

amounts of current. Figure 1 describes a recommended circuit design showing current limiting resistors R_1 and R_2 which are necessary in order to prevent

damage to the output transistors Q1 and Q2 (see Note 7). A bypass capacitor C_1 is also recommended to reduce power supply noise.

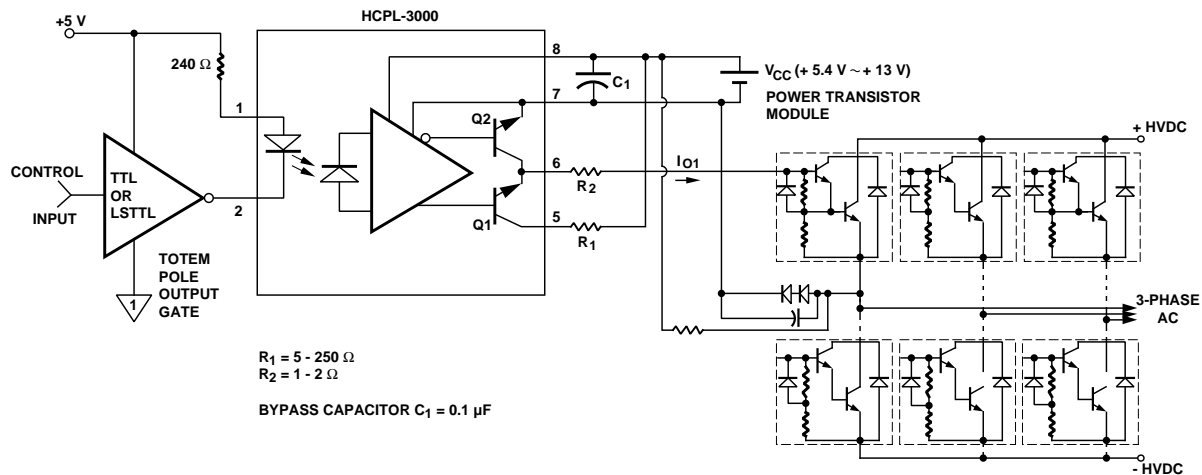

Figure 1. Recommended Output Transistor Protection and Typical Application Circuit.

Electrical Specifications

Over recommended temperature ($T_A = -20^\circ\text{C}$ to $+80^\circ\text{C}$) unless otherwise specified.

Parameter	Sym.	Min.	Typ.	Max.	Units	Test Conditions	Fig.	Note	
Input Forward Voltage	V_F	-	1.1	1.4	V	$I_F = 5 \text{ mA}$, $T_A = 25^\circ\text{C}$	13		
		0.6	0.9	-	V	$I_F = 0.2 \text{ mA}$, $T_A = 25^\circ\text{C}$			
Input Reverse Current	I_R	-	-	10	μA	$V_R = 3 \text{ V}$, $T_A = 25^\circ\text{C}$			
Input Capacitance	C_{IN}	-	30	250	pF	$V_F = 0 \text{ V}$, $f = 1 \text{ kHz}$, $T_A = 25^\circ\text{C}$			
Output 1	Low Level Voltage	V_{O1L}	-	0.2	0.4	V	$V_{CC} = 6 \text{ V}$, $I_{O1} = 0.4 \text{ A}$, $R_{L2} = 10 \Omega$, $I_F = 5 \text{ mA}$	2, 16, 17	2
	Leakage Current	I_{O1L}	-	-	200	μA	$V_{CC} = V_{O1} = 13 \text{ V}$, $V_{O2} = 0 \text{ V}$, $I_F = 0 \text{ mA}$	4	
Output 2	High Level Voltage	V_{O2H}	4.5	5.0	-	V	$V_{CC} = 6 \text{ V}$, $I_{O2} = -0.4 \text{ A}$, $I_F = 5 \text{ mA}$, $V_{O1} = 6 \text{ V}$	3, 18, 19	2
	Low Level Voltage	V_{O2L}	-	0.2	0.4	V	$V_{CC} = 6 \text{ V}$, $I_{O2} = 0.5 \text{ A}$, $I_F = 0 \text{ mA}$	20, 21	
	Leakage Current	I_{O2L}	-	-	200	μA	$V_{CC} = 13 \text{ V}$, $I_F = 5 \text{ mA}$, $V_{O2} = 13 \text{ V}$	5	
Supply Current	High Level	I_{CCH}	-	9	13	mA	$T_A = 25^\circ\text{C}$	22	2
			-	-	17		$V_{CC} = 6 \text{ V}$, $I_F = 5 \text{ mA}$		
	Low Level	I_{CCL}	-	11	15	mA	$T_A = 25^\circ\text{C}$	23	
-	-	20		$V_{CC} = 6 \text{ V}$, $I_F = 0 \text{ mA}$					
Low to High Threshold Input Current	I_{FLH}	0.3	1.5	3.0	mA	$T_A = 25^\circ\text{C}$	6, 14, 15	3	
		0.2	-	5.0	mA	$V_{CC} = 6 \text{ V}$, $R_{L1} = 5 \Omega$, $R_{L2} = 10 \Omega$			

Switching Specifications ($T_A = 25^\circ\text{C}$)

Parameter	Sym.	Min.	Typ.	Max.	Units	Test Conditions	Fig.	Note
Propagation Delay Time to High Output Level	t_{PLH}	-	2	5	μs	$V_{CC} = 6\text{ V}$, $I_F = 5\text{ mA}$, $R_{L1} = 5\ \Omega$, $R_{L2} = 10\ \Omega$	7, 24, 25	2, 6
Propagation Delay Time to Low Output Level	t_{PHL}	-	2	5				
Rise Time	t_r	-	0.2	1				
Fall Time	t_f	-	0.1	1				
Output High Level Common Mode Transient Immunity	$ CM_H $	1500	-	-	$\text{V}/\mu\text{s}$	$V_{CM} = 600\text{ V Peak}$, $I_F = 5\text{ mA}$, $R_{L1} = 470\ \Omega$, $R_{L2} = 1\ \text{k}\Omega$, $\Delta V_{02H} = 0.5\text{ V}$	8	2
Output Low Level Common Mode Transient Immunity	$ CM_L $	1500	-	-	$\text{V}/\mu\text{s}$	$V_{CM} = 600\text{ V Peak}$, $I_F = 0\text{ mA}$, $R_{L1} = 470\ \Omega$, $R_{L2} = 1\ \text{k}\Omega$, $\Delta V_{02L} = 0.5\text{ V}$		

Package Characteristics

Parameter	Sym.	Min.	Typ.	Max.	Units	Test Conditions	Fig.	Note
Input-Output Momentary Withstand Voltage*	V_{ISO}	5000			V rms	RH = 40% to 60%, $t = 1\text{ min.}$, $T_A = 25^\circ\text{C}$		4, 5
Resistance (Input-Output)	R_{I-O}	5×10^{10}	10^{11}	-	Ω	$V_{I-O} = 500\text{ V}$, $T_A = 25^\circ\text{C}$, RH = 40% to 60%		4
Capacitance (Input-Output)	C_{I-O}	-	1.2	-	pF	$f = 1\text{ MHz}$		4

*The Input-Output Momentary Withstand Voltage is a dielectric voltage rating that should not be interpreted as an input-output continuous voltage rating. For the continuous voltage rating refer to the VDE 0884 Insulation Characteristics Table (if applicable), your equipment level safety specification, or HP Application Note 1074, "Optocoupler Input-Output Endurance Voltage."

Notes:

- Derate absolute maximum ratings with ambient temperatures as shown in Figures 9, 10, and 11.
- A bypass capacitor of $0.01\ \mu\text{F}$ or more is needed near the device between V_{CC} and GND when measuring output and transfer characteristics.
- I_{FLH} represents the forward current when the output goes from low to high.
- Device considered a two terminal device; pins 1-4 are shorted together and pin 5-8 are shorted together.
- For devices with minimum V_{ISO} specified at 5000 V rms, in accordance with UL1577, each optocoupler is proof-tested by applying an insulation test voltage $\geq 6000\text{ Vrms}$ for one second (leakage current detection limit, $I_{I-O} \leq 200\ \mu\text{A}$).
- The t_{PLH} and t_{PHL} propagation delays are measured from the 50% level of the input pulse to the 50% level of the output pulse.
- R_1 sets the base current (I_{O1} in Figure 1) supplied to the power bipolar device. R_2 limits the peak current seen by Q2 when the device is turning off. For more applications and circuit design information see Application Note "Power Transistor Gate/Base Drive Optocouplers."

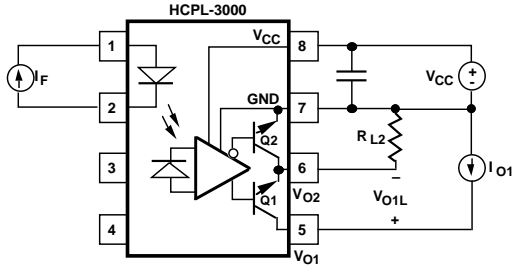

Figure 2. Test Circuit for Low Level Output Voltage V_{O1L} .

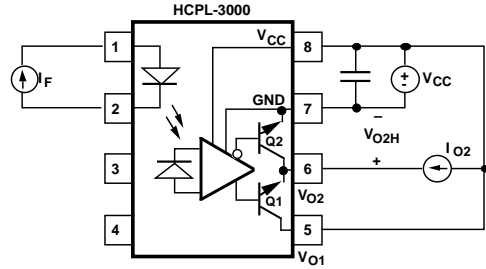

Figure 3. Test Circuit for High Level Output Voltage V_{O2H} .

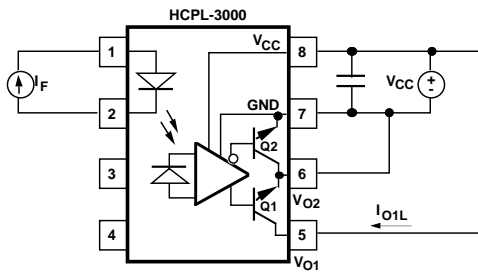

Figure 4. Test Circuit for Leakage Current I_{O1L} .

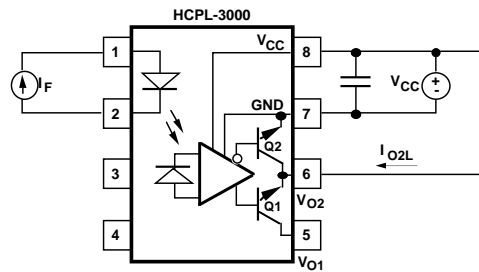

Figure 5. Test Circuit for Leakage Current I_{O2L} .

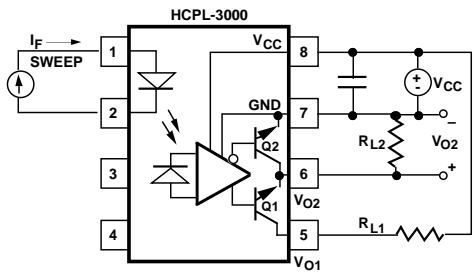

Figure 6. Test Circuit for Threshold Input Current I_{FLH} .

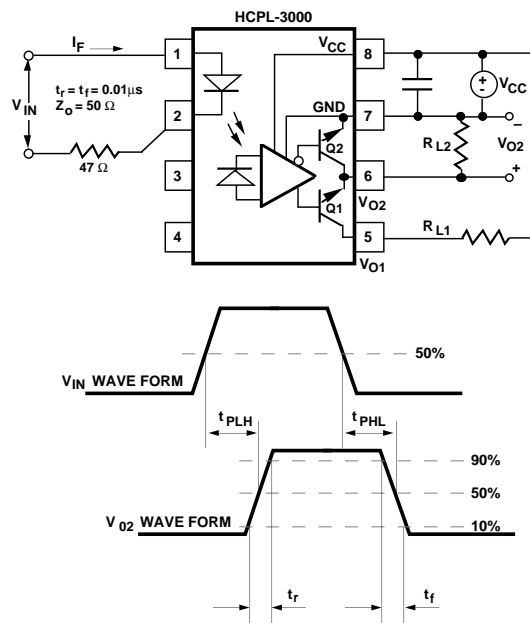

Figure 7. Test Circuit for t_{PLH} , t_{PHL} , t_r and t_f .

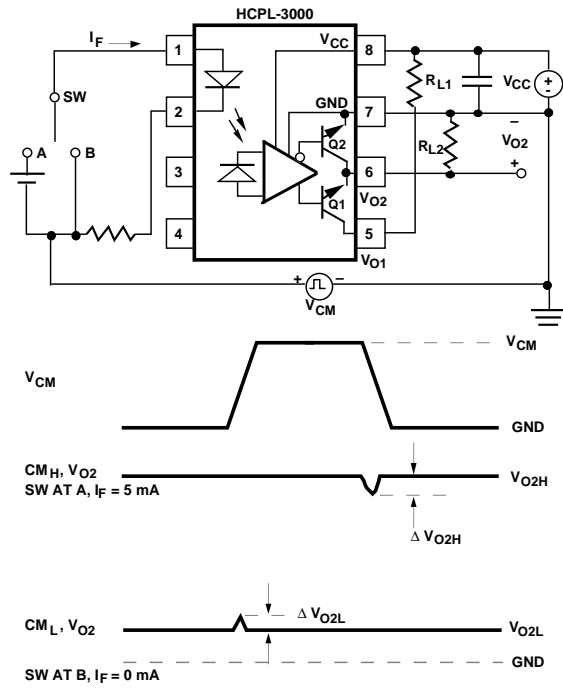

Figure 8. Test Circuit for CM_H and CM_L .

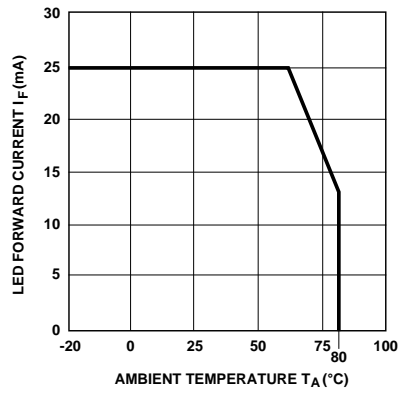

Figure 9. LED Forward Current vs. Ambient Temperature.

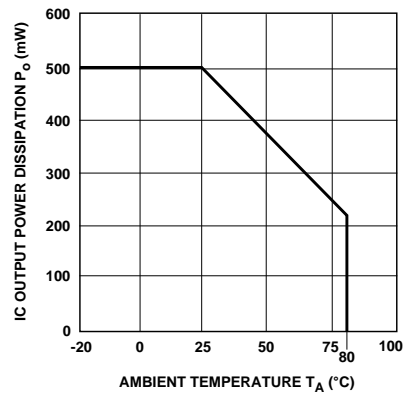

Figure 10. Maximum IC Output Power Dissipation vs. Ambient Temperature.

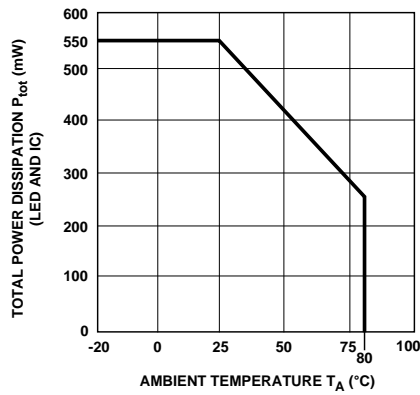

Figure 11. Maximum Total Power Dissipation vs. Ambient Temperature.

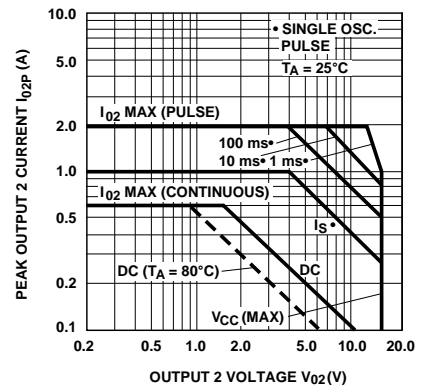

Figure 12. Typical Peak Output 2 Current vs. Output 2 Voltage (Safe Operating Area Q2).

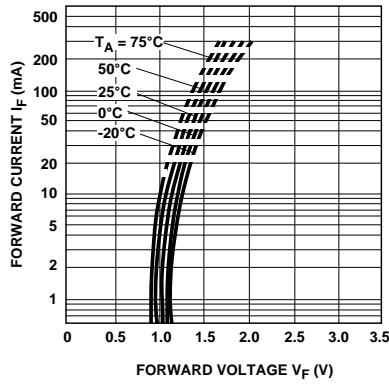

Figure 13. Typical Forward Current vs. Forward Voltage.

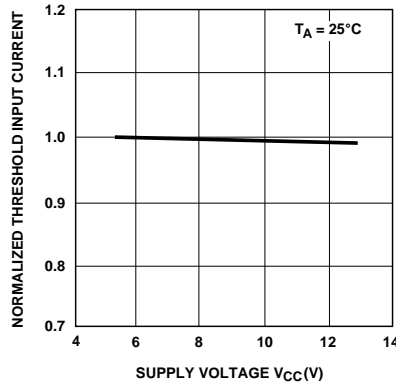

Figure 14. Normalized Low to High Threshold Input Current vs. Supply Voltage.

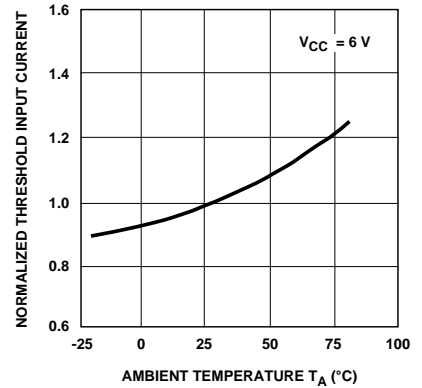

Figure 15. Normalized Low to High Threshold Input Current vs. Ambient Temperature.

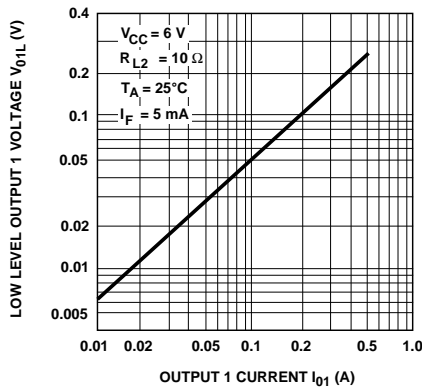

Figure 16. Typical Low Level Output 1 Voltage vs. Output 1 Current.

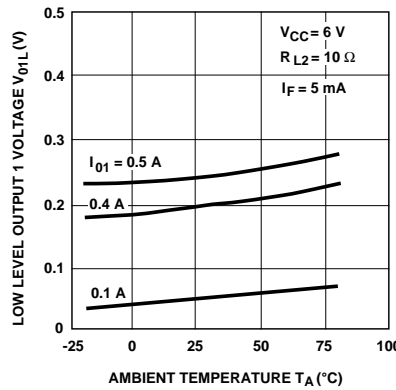

Figure 17. Typical Low Level Output 1 Voltage vs. Ambient Temperature.

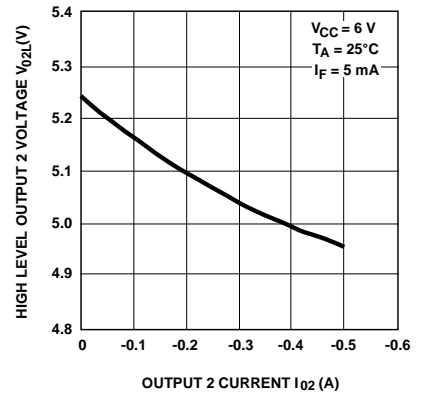

Figure 18. Typical High Level Output 2 Voltage vs. Output 2 Current.

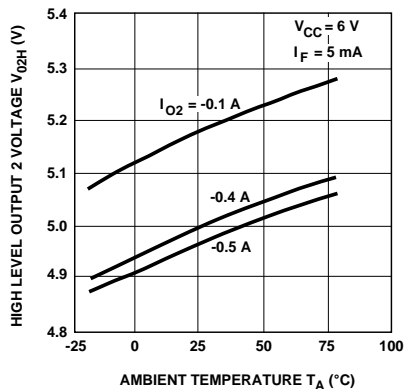

Figure 19. Typical High Level Output 2 Voltage vs. Ambient Temperature.

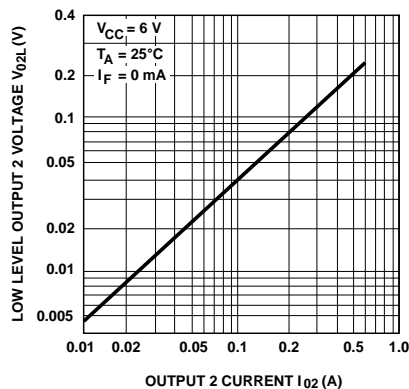

Figure 20. Typical Low Level Output 2 Voltage vs. Output 2 Current.

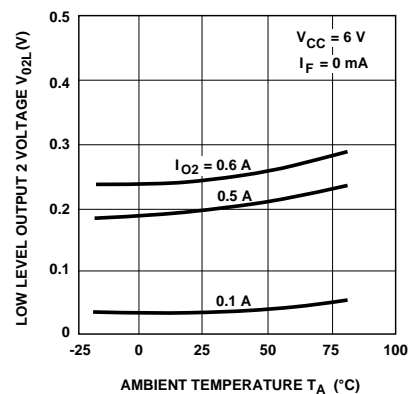

Figure 21. Typical Low Level Output 2 Voltage vs. Ambient Temperature.

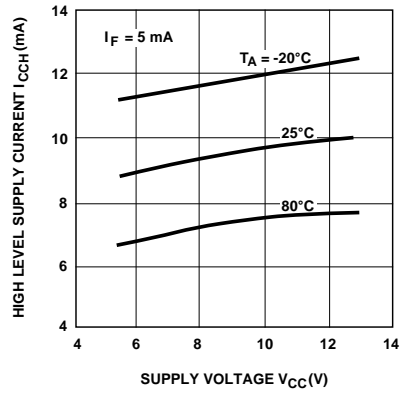

Figure 22. Typical High Level Supply Current vs. Supply Voltage.

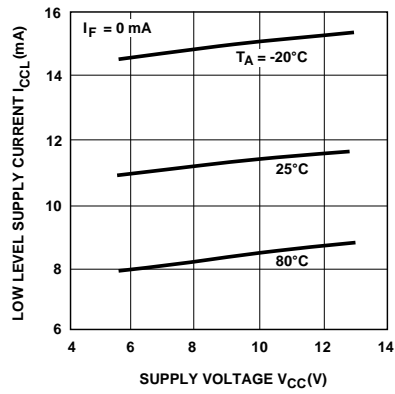

Figure 23. Typical Low Level Supply Current vs. Supply Voltage.

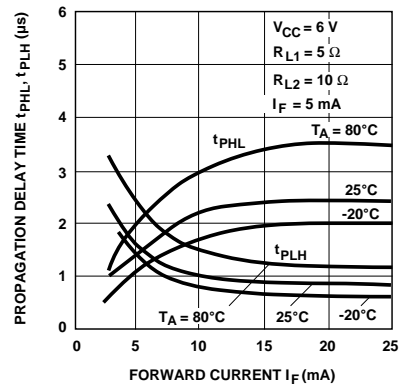

Figure 24. Typical Propagation Delay Time vs. Forward Current.

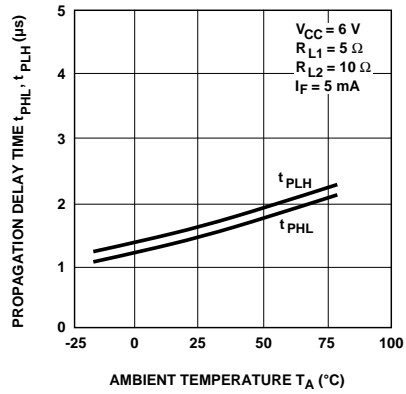

Figure 25. Typical Propagation Delay Time vs. Ambient Temperature.