

HMCS47C(HD44860), HMCS47CL(HD44868)

The HMCS47C is the CMOS 4-bit single chip microcomputer which contains ROM, RAM, I/O and Timer/Counter on single chip. The HMCS47C is designed to perform efficient controller function as well as arithmetic function for both binary and BCD data. The CMOS technology of the HMCS47C provides the flexibility of microcomputers for battery powered and battery back-up applications.

■ FEATURES

- 4-bit Architecture
- 4,096 Words of Program ROM and Pattern ROM (10 bits/Word)
- 256 Digits of Data RAM (4 bits/Digit)
- 44 I/O Lines and 2 External Interrupt Lines
- Timer/Counter
- Instruction Cycle Time;
 - HMCS47C : 5 μ s
 - HMCS47CL : 20 μ s
- All Instructions except One Instruction; Single Word and Single Cycle
- BCD Arithmetic Instructions
- Pattern Generation Instruction
 - Table Look Up Capability –
- Powerful Interrupt Function
 - 3 Interrupt Sources
 - └ 2 External Interrupt Lines
 - └ Timer/Counter
 - Multiple Interrupt Capability
- Bit Manipulation Instructions for Both RAM and I/O
- Option of I/O Configuration Selectable on Each Pin; With Pull up MOS or CMOS or Open Drain
- Built-in Oscillator
- Built-in Power-on Reset Circuit (HMCS47C only)
- Low Operating Power Dissipation; 3.3mW typ.
- Stand-by Mode (Halt Mode); 66 μ W max.
- CMOS Technology
- Single Power Supply;
 - HMCS47C : 5V \pm 10%
 - HMCS47CL : 2.5V to 5.5V

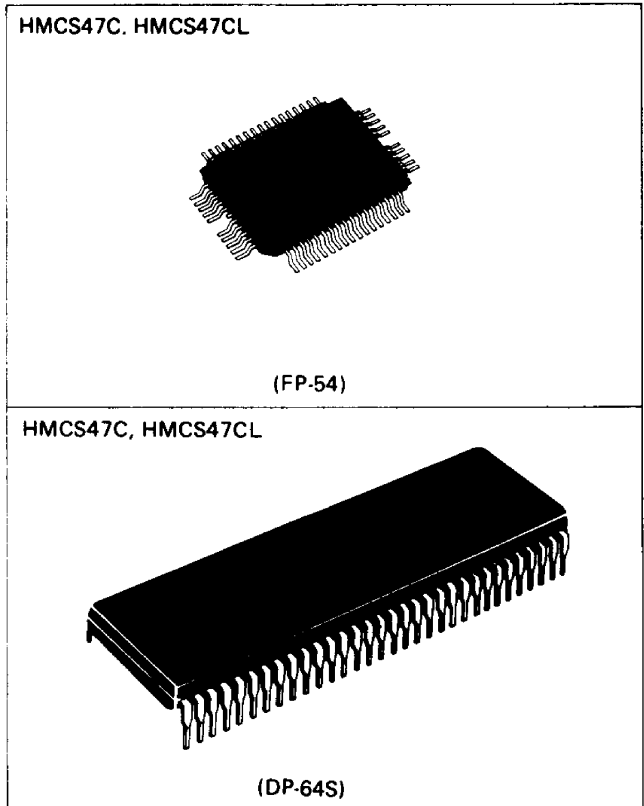

■ PIN ARRANGEMENT

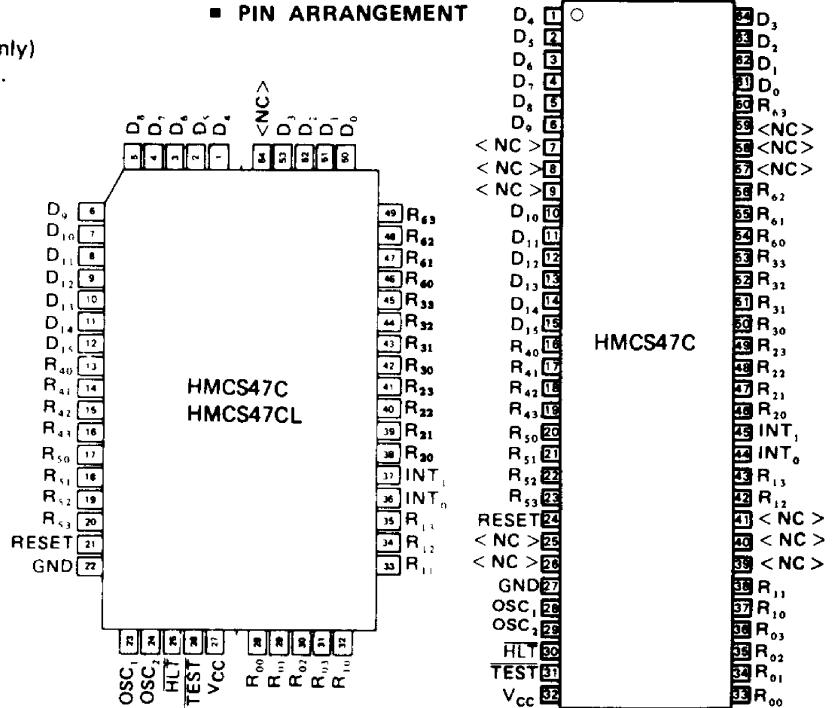

(Top View)

(Top View)

■ BLOCK DIAGRAM

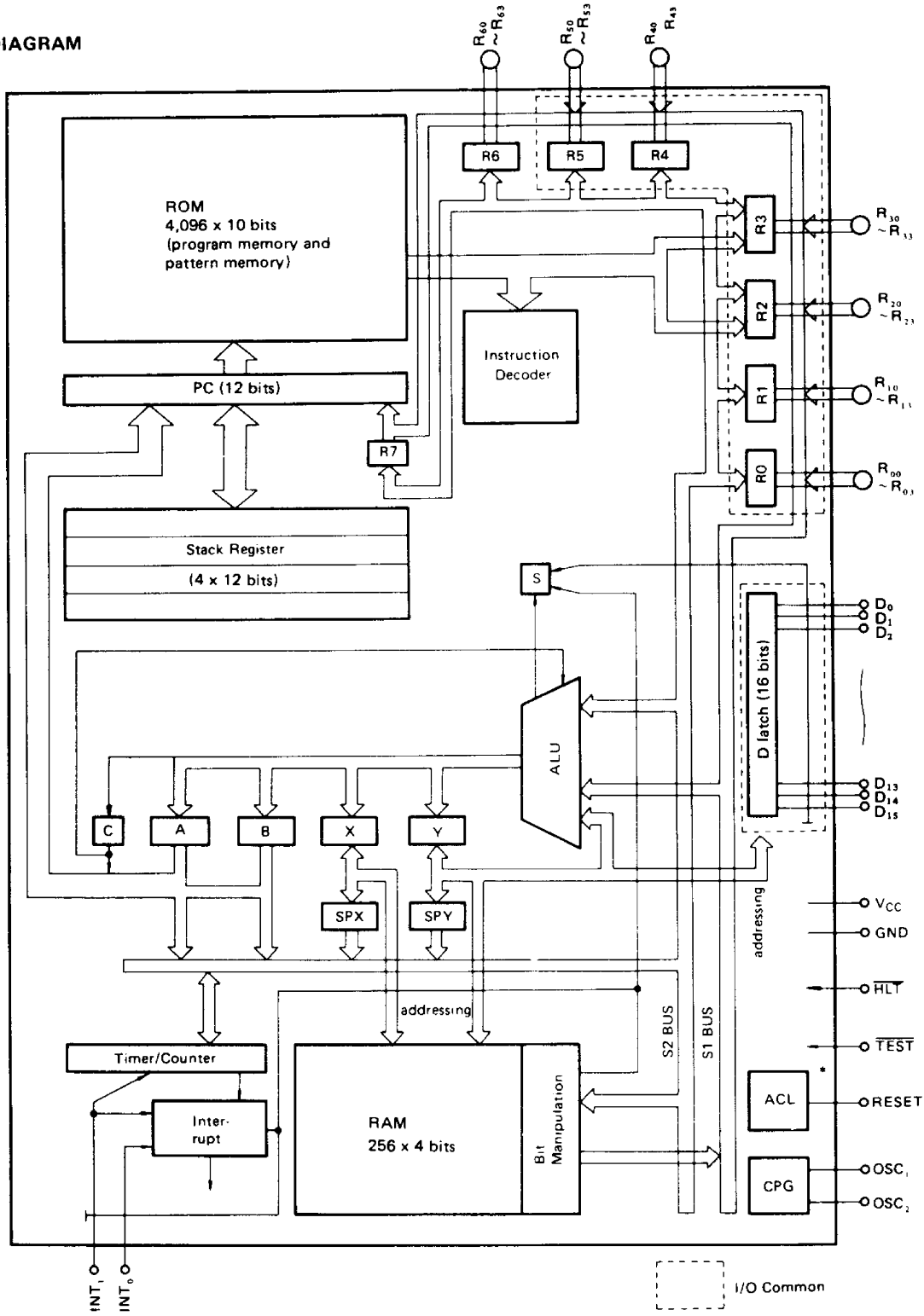

- HMCS47C ELECTRICAL CHARACTERISTICS ($V_{CC} = 5V \pm 10\%$)
- ABSOLUTE MAXIMUM RATINGS

Item	Symbol	Value	Unit	Remarks
Supply Voltage	V_{CC}	-0.3 to +7.0	V	
Pin Voltage (1)	V_{T1}	-0.3 to $V_{CC} + 0.3$	V	Except for the pins specified by V_{T2}
Pin Voltage (2)	V_{T2}	-0.3 to +10.0	V	Applied to the Open Drain type of Output pins and Open Drain type of I/O pins.
Maximum Total Output Current (1)	$-\Sigma I_{O1}$	45	mA	[NOTE 3]
Maximum Total Output Current (2)	ΣI_{O2}	45	mA	[NOTE 3]
Operating Temperature	T_{opr}	-20 to +75	°C	
Storage Temperature	T_{stg}	-55 to +125	°C	

[NOTE 1] Permanent LSI damage may occur if "Maximum Ratings" are exceeded. Normal operation should be under the conditions of "ELECTRICAL CHARACTERISTICS -1, -2". If these conditions are exceeded, it could be cause of malfunction of LSI and affects reliability of LSI.

[NOTE 2] All voltages are with respect to GND.

[NOTE 3] The Maximum Total Output Current is total sum of output currents which can flow out (or flow in) from or into the I/O pins and Output pins simultaneously.

• ELECTRICAL CHARACTERISTICS-1 ($V_{CC} = 5V \pm 10\%$, $T_a = -20^{\circ}C$ to $+75^{\circ}C$)

Item	Symbol	Test Conditions	Value			Unit	Note	
			min	typ	max			
Input "Low" Voltage	V_{IL}		–	–	1.0	V		
Input "High" Voltage (1)	V_{IH1}		$V_{CC} - 1.0$	–	V_{CC}	V	2	
Input "High" Voltage (2)	V_{IH2}		$V_{CC} - 1.0$	–	10	V	3	
Output "Low" Voltage	V_{OL}	$I_{OL} = 1.6mA$	–	–	0.8	V		
Output "High" Voltage (1)	V_{OH1}	$-I_{OH} = 1.0mA$	2.4	–	–	V	4	
Output "High" Voltage (2)	V_{OH2}	$-I_{OH} = 0.01mA$	$V_{CC} - 0.3$	–	–	V	5	
Interrupt Input Hold Time	t_{INT}		$2 \cdot T_{inst}$	–	–	μs		
Interrupt Input Fall Time	t_{fINT}		–	–	50	μs		
Interrupt Input Rise Time	t_{rINT}		–	–	50	μs		
Output "High" Current	I_{OH}	$V_{OH} = 10V$	–	–	3	μA	6	
Input Leakage Current	I_{IL}	$V_{in} = 0$ to V_{CC}	–	–	1	μA	2	
		$V_{in} = 0$ to 10V	–	–	3	μA	3	
Pull up MOS Current	$-I_P$	$V_{CC} = 5V$	60	–	250	μA		
Supply Current (1)	I_{CC1}	$V_{in} = V_{CC}$, $V_{CC} = 5V$, Ceramic Filter Oscillation ($f_{osc} = 800kHz$)	–	–	2.0	mA	7	
Supply Current (2)	I_{CC2}	$V_{in} = V_{CC}$, $V_{CC} = 5V$ R_f Oscillation ($f_{osc} = 800kHz$) External Clock Operation ($f_{cp} = 800kHz$)	–	–	0.85	mA	7	
Standby I/O Leakage Current	I_{LS}	HLT = 1.0V	$V_{in} = 0$ to V_{CC}	–	–	1	μA	5, 8
			$V_{in} = 0$ to 10V	–	–	3	μA	6, 8
Standby Supply Current	I_{CCS}	$V_{in} = V_{CC}$, HLT = 0.2V	–	–	12	μA	9	
External Clock Operation								
External Clock Frequency	f_{cp}		350	–	850	kHz		
External Clock Duty	Duty		45	50	55	%		
External Clock Rise Time	t_{rcp}		0	–	0.2	μs		
External Clock Fall Time	t_{fcp}		0	–	0.2	μs		
Instruction Cycle Time	T_{inst}	$T_{inst} = 4/f_{cp}$	4.7	–	11.4	μs		
Internal Clock Operation (R_f Oscillation)								
Clock Oscillation Frequency	f_{osc}	$R_f = 51k\Omega \pm 2\%$	540	–	900	kHz		
Instruction Cycle Time	T_{inst}	$T_{inst} = 4/f_{osc}$	4.4	–	7.4	μs		
Internal Clock Operation (Ceramic Filter Oscillation)								
Clock Oscillation Frequency	f_{osc}	Ceramic Filter Circuit	784	–	816	kHz		
Instruction Cycle Time	T_{inst}	$T_{inst} = 4/f_{osc}$	4.9	–	5.1	μs		

[NOTE 1] All voltages are with respect to GND.

[NOTE 2] This is applied to RESET, HLT, OSC_1 , INT_0 , INT_1 and the With Pull up MOS or CMOS type of I/O pins.

[NOTE 3] This is applied to the Open Drain type of I/O pins.

[NOTE 4] This is applied to the CMOS type of I/O or Output pins.

[NOTE 5] This is applied to the With Pull up MOS or CMOS type of I/O or Output pins.

[NOTE 6] This is applied to the Open Drain type of I/O or Output pins.

[NOTE 7] I/O current is excluded.

[NOTE 8] The Standby I/O Leakage Current is the I/O leakage current in the Halt and Disable State.

[NOTE 9] I/O current is excluded.

The Standby Supply Current is the supply current at $V_{CC} = 5V \pm 10\%$ in the Halt State. The supply current in the case where the supply voltage falls to the Halt Duration voltage is called the Halt Current (I_{DH}), and it is shown in "ELECTRICAL CHARACTERISTICS -2."



● ELECTRICAL CHARACTERISTICS-2 (Ta = -20°C to +75°C)

Reset and Halt

Item	Symbol	Test Conditions	Value		Unit
			min	max	
Halt Duration Voltage	V_{DH}	$\overline{HLT} = 0.2V$	2.3	—	V
Halt Current	I_{DH}	$V_{in} = V_{CC}$ $\overline{HLT} = 0.2V, V_{DH} = 2.3V$	—	1.2	μA
Halt Delay Time	t_{HD}		100	—	μs
Operation Recovery Time	t_{RC}		100	—	μs
\overline{HLT} Fall Time	t_{fHLT}		—	1000	μs
\overline{HLT} Rise Time	t_{rHLT}		—	1000	μs
\overline{HLT} "Low" Hold Time	t_{HLT}		400	—	μs
\overline{HLT} "High" Hold Time	t_{OPR}	Rf Oscillation, External Clock Operation	0.1	—	ms
		Ceramic Filter Oscillation	4	—	
Power Supply Rise Time	t_{rCC}	Built-in Reset, $\overline{HLT} = V_{CC}$	0.1	10	ms
Power Supply OFF Time	t_{OFF}	Built-in Reset $\overline{HLT} = V_{CC}$	1	—	ms
RESET Pulse Width (1)	t_{RST1}	External Reset $V_{CC} = 4.5$ to $5.5V, \overline{HLT} = V_{CC}$ (Rf Oscillation, External Clock Operation)	1	—	ms
		External Reset $V_{CC} = 4.5$ to $5.5V, \overline{HLT} = V_{CC}$ (Ceramic Filter Oscillation)	4	—	
RESET Pulse Width (2)	t_{RST2}	External Reset $V_{CC} = 4.5$ to $5.5V,$ $\overline{HLT} = V_{CC}$	$2 \cdot T_{inst}$	—	μs
RESET Fall Time	t_{fRST}	$\overline{HLT} = V_{CC}$	—	20	ms
RESET Rise Time	t_{rRST}	$\overline{HLT} = V_{CC}$	—	20	ms

[NOTE] All voltages are with respect to GND.

■ HMCS47CL ELECTRICAL CHARACTERISTICS (2.5V to 5.5V)

● ABSOLUTE MAXIMUM RATINGS

Item	Symbol	Value	Unit	Remarks
Supply Voltage	V_{CC}	-0.3 to +7.0	V	
Pin Voltage (1)	V_{T1}	-0.3 to $V_{CC} + 0.3$	V	Except for the pins specified by V_{T2}
Pin Voltage (2)	V_{T2}	-0.3 to +10.0	V	Applied to the Open Drain type of Output pins and Open Drain type of I/O pins.
Maximum Total Output Current (1)	$-\Sigma I_{O1}$	45	mA	[NOTE 3]
Maximum Total Output Current (2)	ΣI_{O2}	45	mA	[NOTE 3]
Operating Temperature	T_{opr}	-20 to +75	°C	
Storage Temperature	T_{stg}	-55 to +125	°C	

[NOTE 1] Permanent LSI damage may occur if "Maximum Ratings" are exceeded. Normal operation should be under the conditions of "ELECTRICAL CHARACTERISTICS -1, -2." If these conditions are exceeded, it could be cause of malfunction of LSI and affects reliability of LSI.

[NOTE 2] All voltages are with respect to GND.

[NOTE 3] The Maximum Total Output Current is total sum of output currents which can flow out (or flow in) from or into the I/O pins and Output pins simultaneously.



● ELECTRICAL CHARACTERISTICS – 1 ($V_{CC} = 2.5$ to $5.5V$, $T_a = -20$ to $+75^{\circ}C$)

Item	Symbol	Test Conditions	Value			Unit	Note	
			min	typ	max			
Input "Low" Voltage	V_{IL}		–	–	$0.15 \cdot V_{CC}$	V		
Input "High" Voltage (1)	V_{IH1}		$0.85 \cdot V_{CC}$	–	V_{CC}	V	2	
Input "High" Voltage (2)	V_{IH2}		$0.85 \cdot V_{CC}$	–	10	V	3	
Output "Low" Voltage	V_{OL}	$I_{OL} = 0.4$ mA	–	–	0.4	V		
Output "High" Voltage	V_{OH}	$-I_{OH} = 0.08$ mA	$V_{CC} - 0.4$	–	–	V	4	
Interrupt Input Hold Time	t_{INT}		$2 \cdot T_{inst}$	–	–	μs		
Interrupt Input Fall Time	t_{fINT}		–	–	50	μs		
Interrupt Input Rise Time	t_{rINT}		–	–	50	μs		
Output "High" Level Current	I_{OH}	$V_{OH} = 10$ V	–	–	3	μA	6	
Input Leakage Current	I_{IL}	$V_{in} = 0$ to V_{CC}	–	–	1.0	μA	2	
		$V_{in} = 0$ to 10V	–	–	3		3	
Pull up MOS Current	$-I_p$	$V_{CC} = 3V$	10	–	80	μA		
Supply Current	I_{CC}	$V_{in} = V_{CC}$, $V_{CC} = 3V$ ($f_{osc}/f_{cp} = 200kHz$) R_f Oscillation, External Clock Operation	–	–	140	μA	7	
Standby I/O Leakage Current	I_{LS}	$\overline{HLT} = 0.5V$	$V_{in} = 0$ to V_{CC}	–	–	1	μA	5, 8
			$V_{in} = 0$ to 10V	–	–	3	μA	6, 8
Standby Supply Current	I_{CCS}	$V_{in} = V_{CC}$	$V_{CC} = 2.5$ to $3.5V$	–	–	6	μA	9
		$\overline{HLT} = 0.1V$	$V_{CC} = 2.5$ to $5.5V$	–	–	10	μA	
External Clock Operation								
External Clock Frequency	f_{cp}		130	200	240	kHz		
External Clock Duty	Duty		45	50	55	%		
External Clock Rise Time	t_{rcp}		0	–	0.2	μs		
External Clock Fall Time	t_{fcp}		0	–	0.2	μs		
Instruction Cycle Time	T_{inst}	$T_{inst} = 4/f_{cp}$	16.8	20	30.8	μs		
Internal Clock Operation (R_f Oscillation)								
Clock Oscillation Frequency	f_{osc}	$R_f = 200k\Omega \pm 2\%$ $V_{CC} = 2.5$ to $3.5V$	130	–	250	kHz		
	f_{osc}	$R_f = 200k\Omega \pm 2\%$ $V_{CC} = 2.5$ to $5.5V$	130	–	350	kHz		
Instruction Cycle Time	T_{inst}	$T_{inst} = 4/f_{osc}$ $V_{CC} = 2.5$ to $3.5V$	16	–	30.8	μs		
	T_{inst}	$T_{inst} = 4/f_{osc}$ $V_{CC} = 2.5$ to $5.5V$	11.4	–	30.8	μs		

[NOTE 1] All voltages are with respect to GND.

[NOTE 2] This is applied to RESET, \overline{HLT} , OSC_1 , INT_0 , INT_1 and the With Pull up MOS or CMOS type of I/O pins.

[NOTE 3] This is applied to the Open Drain type of I/O pins.

[NOTE 4] This is applied to the CMOS type of I/O or Output pins.

[NOTE 5] This is applied to the With Pull up MOS or CMOS type of I/O or Output pins

[NOTE 6] This is applied to the Open Drain type of I/O or Output pins.

[NOTE 7] I/O current is excluded.

[NOTE 8] The Standby I/O Leakage Current is the I/O leakage current in the Halt and Disable State.

[NOTE 9] I/O current is excluded.

The Standby Supply Current is the supply current at $V_{CC} = 2.5$ to $5.5V$ in the Halt State. The supply current in the case where the supply voltage falls to the Halt Duration voltage is called the Halt Current (I_{DH}), and it is shown in "ELECTRICAL CHARACTERISTICS -2."



● ELECTRICAL CHARACTERISTICS – 2 (Ta = -20 to +75°C)
Reset and Halt

Item	Symbol	Test Conditions	Value		Unit
			min	max	
Halt Duration Voltage	V _{DH}	HLT = 0.2V	2.0	–	V
Halt Current	I _{DH}	V _{in} =V _{CC} , V _{DH} =2.0V HLT = 0.1V	–	12	μA
Halt Delay Time	t _{HD}		200	–	μs
Operation Recovery Time	t _{RC}		200	–	μs
HLT Fall Time	t _{fHLT}		–	1000	μs
HLT Rise Time	t _{rHLT}		–	1000	μs
HLT "Low" Hold Time	t _{HLT}		800	–	μs
HLT "High" Hold Time	t _{OPR}	R _f Oscillation, External Clock Operation, V _{CC} =2.5 to 5.5V	0.2	–	ms
RESET Pulse Width (1)	t _{RST1}	External Reset V _{CC} =2.5 to 5.5V HLT = V _{CC} R _f Oscillation, External Clock Operation	2	–	ms
RESET Pulse Width (2)	t _{RST2}	External Reset V _{CC} =2.5 to 5.5V HLT = V _{CC}	2·T _{inst}	–	μs
RESET Fall Time	t _{fRST}	HLT = V _{CC}	–	20	ms
RESET Rise Time	t _{rRST}	HLT = V _{CC}	–	20	ms

(NOTE) All voltages are with respect to GND.

■ SIGNAL DESCRIPTION

The input and output signals for the HMCS47C, shown in PIN ARRANGEMENT, are described in the following paragraphs.

● V_{CC} and GND

Power is supplied to the HMCS47C using these two pins. V_{CC} is power and GND is the ground connection.

● RESET

This pin resets the HMCS47C independently of the automatic resetting capability (ACL; Built-in Reset Circuit) already in the HMCS47C. The HMCS47C can be reset by pulling RESET high.

Refer to RESET FUNCTION for additional information.

● OSC₁ and OSC₂

These pins provide control input for the built-in oscillator circuit. A resistor, ceramic filter circuit, or an external oscillator can be connected to these pins to provide a system clock with various degrees of stability/cost tradeoffs. Lead length and stray capacitance on these two pins should be minimized.

Refer to OSCILLATOR for recommendations about these pins.

● HLT

This pin is used to enter the HMCS47C into the Halt State (Stand-by Mode).

The HMCS47C can be moved into the Halt State by pulling

HLT low.

In the Halt State, the internal clock stops and all the internal statuses (the RAM, the registers, the Carry F/F, the Status F/F, the Program Counter, etc.) are held.

Consequently, the power consumption is reduced. By pulling HLT high, the HMCS47C starts operation from the state just before the Halt State.

Refer to HALT FUNCTION for details of the Halt Mode.

● TEST

This pin is not for user application and must be connected to V_{CC}.

● INT₀ and INT₁

These pins generate interrupt request to the HMCS47C.

Refer to INTERRUPTS for additional information.

● R₀₀ – R₀₃, R₁₀ – R₁₃, R₂₀ – R₂₃, R₃₀ – R₃₃, R₄₀ – R₄₃, R₅₀ – R₅₃

These 24 lines are arranged into six 4-bit Data Input/Output Common Channels. The 4-bit registers (Data I/O Register) are attached to these channels. Each channel is directly addressed by the operand of input/output instruction.

Refer to INPUT/OUTPUT for additional information.

● R₆₀ – R₆₃

These 4 lines are the 4-bit Data Output Channel. The 4-bit register (Data I/O Register) is attached to this channel. The channel is directly addressed by the operand of output instruction.



tion.

Refer to INPUT/OUTPUT for additional information.

• **D₀ - D₁₅**

These lines are sixteen 1-bit Discrete Input/Output Common Pins. The 1-bit latches are attached to these pins. Each pin is addressed by the Y register. The D₀ to D₃ pins are also addressed directly by the operand of input/output instruction.

Refer to INPUT/OUTPUT for additional information.

■ **ROM**

● **ROM Address Space**

ROM is used as a memory for the instructions and the patterns (constants). The instruction used in the HMCS47C consists of 10 bits. These 10 bits are called "a word", which is a unit for writing into ROM.

The ROM address has been split into two banks.

Each bank is composed of 32 pages (64 words/page).

The ROM capacity is 4,096 words (1 word = 10 bits) in all.

All addresses can contain both the instructions and the patterns (constants).

The ROM address space is shown in Figure 1.

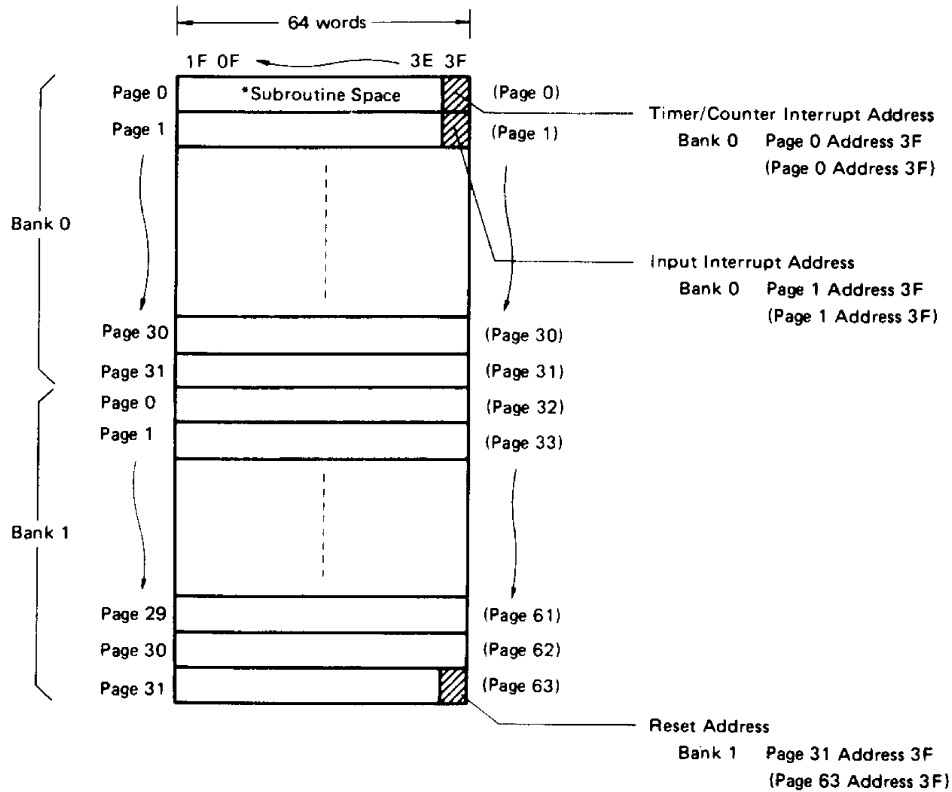

*Bank 0 Page 0 (Page 0) is the Subroutine Space.

Note: The parenthesized contents are expressions of the Page, combining the bank part with the page part.

Figure 1 ROM Address Space



● Program Counter (PC)

The program counter is used for addressing of ROM. The

program counter consists of the bank part, the page part, and the address part as shown in Figure 2.

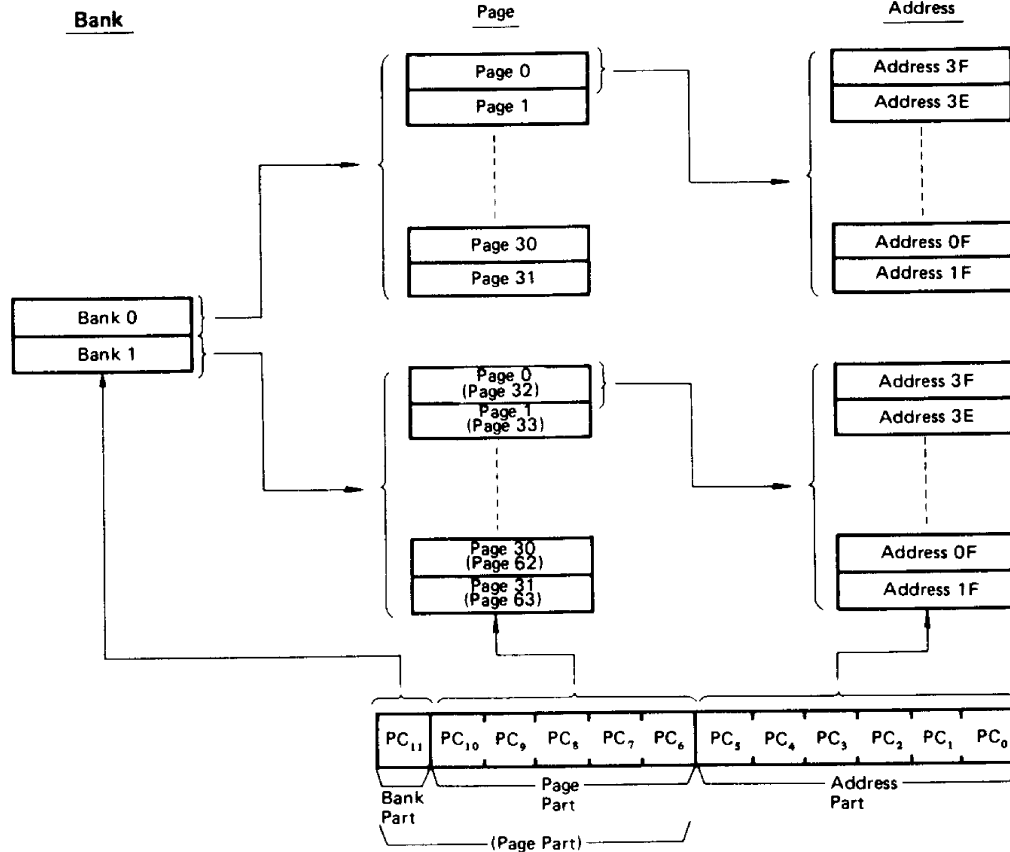

Note: The parenthesized contents are expressions of the Page, combining the bank part with the page part.

Figure 2 Configuration of Program Counter

The bank part is a 1-bit register and the page part is a 5-bit register.

Once a certain value is loaded into the bank part or the page part, it is unchanged until other value is loaded by a program.

“0” (the Bank 0) or “1” (the Bank 1) can be set in the bank part, and any number among 0 to 31 in the page part.

The address part is a 6-bit polynomial counter and counts up for each instruction cycle time. The sequence in the decimal and hexadecimal system is shown in Table 1. This sequence forms a loop and has neither the starting nor ending point. It doesn't generate an overflow carry. Consequently, the program on a same page is executed in order unless the value of the bank part or the page part is changed.

Table 1 Program Counter Address Part Sequence

Decimal	Hexa-decimal	Decimal	Hexa-decimal	Decimal	Hexa-decimal
63	3F	5	05	9	09
62	3E	11	0B	19	13
61	3D	23	17	38	26
59	3B	46	2E	12	0C
55	37	28	1C	25	19
47	2F	56	38	50	32
30	1E	49	31	37	25
60	3C	35	23	10	0A
57	39	6	06	21	15
51	33	13	0D	42	2A
39	27	27	1B	20	14
14	0E	54	36	40	28
29	1D	45	2D	16	10
58	3A	26	1A	32	20
53	35	52	34	0	00
43	2B	41	29	1	01
22	16	18	12	3	03
44	2C	36	24	7	07
24	18	8	08	15	0F
48	30	17	11	31	1F
33	21	34	22		
2	02	4	04		



● **Designation of ROM Address and ROM Code**

The bank part of the ROM address is shown in the binary system and the page part in the decimal system. The address part is divided into 2 bits and 4 bits, and shown in the hexadecimal system.

It is possible to combine the bank part and the page part and show the combined part as the Page (in the decimal system).

In this case, the Page 0 to the Page 31 in the Bank 1 are shown as the Page 32 to the Page 63. The examples are shown in Figure 3.

One word (10 bits) of ROM is divided into three parts (2 bits, 4 bits and 4 bits from the most significant bit O_{10} in order) shown in the hexadecimal system. The examples are shown in Figure 3.

(a) ROM Address

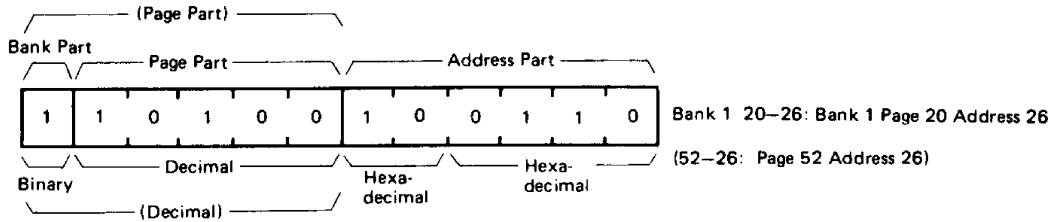

(b) ROM Code

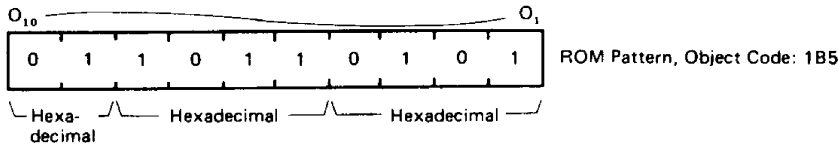

Figure 3 Designation of ROM Address and ROM Code

■ **PATTERN GENERATION**

The pattern (constant) can be accessed by the pattern instruction (P). The pattern can be written in any address of the ROM address space.

● **Reference**

ROM addressing for reference of the patterns is achieved by modifying the program counter with the accumulator, the B register, the Carry F/F and the operand p. Figure 4 shows how to modify the program counter. The address part is replaced with the accumulator and the lower 2 bits of B register, while the page part and the bank part are ORed with the upper 2 bits of B register, the Carry F/F and the operand p.

The bank part of the ROM address to be referenced to is determined by the logical equation: $PC_{11} + p_2$ (p_2 = the MSB of the operand p).

If the address where the pattern instruction exists is in the Bank 1, only the pattern of the Bank 1 can be referenced.

If the address where the pattern instruction exists is in the Bank 0, the pattern of the either Bank 1 or Bank 0 can be referenced depending on the value of p_2 . The truth table of the bank part of the ROM address is shown in Table 2.

The value of the program counter is apparently modified, not changed actually. After execution of the pattern instruction, the program counter counts up and the next instruction is

executed.

The pattern instruction is executed in 2 cycles.

● **Generation**

The pattern of referred ROM address is generated as the following two ways:

- (i) The pattern is loaded into the accumulator and B register.
- (ii) The pattern is loaded into the Data I/O Registers R2 and R3.

The command bits (O_9, O_{10}) in the pattern determine which way is taken.

Mode (i) is performed when O_9 is "1" and mode (ii) is performed when O_{10} is "1".

Mode (i) and (ii) are simultaneously performed when both of O_9 and O_{10} are "1". The correspondence of each bit of the pattern is shown in Figure 5.

Examples of how to use the pattern instruction is shown in Table 3.

CAUTION

In the program execution, the pattern can not be distinguished from the instruction. When the program is running at the address written as a pattern, the instruction corresponding to the pattern bit is executed. Take care not to execute a pattern as an instruction.



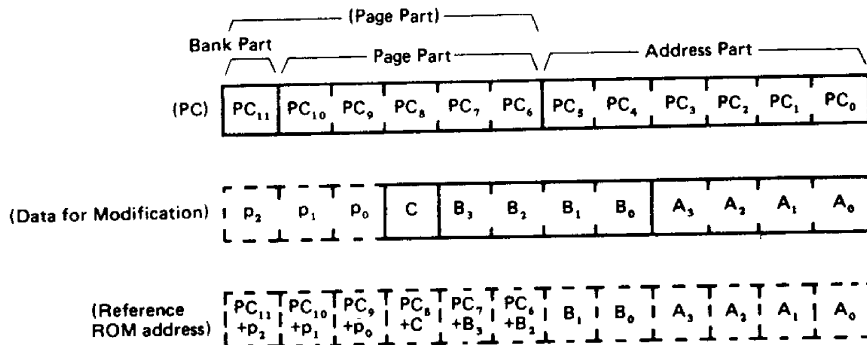

Figure 4 ROM Addressing for Pattern Generation

Table 2 Bank Part Truth Table of Pattern Generation

PC_{11}	p_2	Bank part of ROM address to be referenced to
1 (Bank 1)	1	1 (Bank 1)
	0	1 (Bank 1)
0 (Bank 0)	1	1 (Bank 1)
	0	0 (Bank 0)

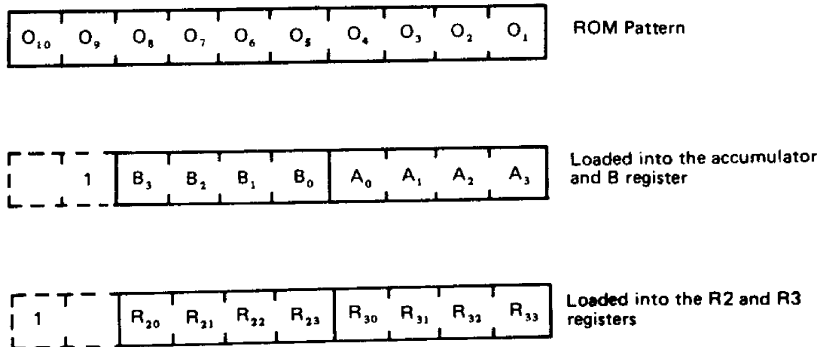

Figure 5 Correspondence of Each Bit of Pattern

Table 3 Example of how to use Pattern Instructions

Before Execution					Referred ROM Address	ROM Pattern	After Execution			
PC	p	C	B	A			B	A	R2	R3
Bank 0 0-3F (0-3F)	1	0	A	0	Bank 0 10-20 (10-20)	12D	2	B	—	—*
Bank 0 0-3F (0-3F)	7	1	4	0	Bank 1 29-00 (61-00)	22D	—	—	4	B
Bank 1 30-00 (62-00)	4	0/1**	0	9	Bank 1 30-09 (62-09)	32D	2	B	4	B
Bank 1 30-00 (62-00)	1	0/1**	F	9	Bank 1 31-39 (63-39)	223	—	—	4	C

* "—" means that the value does not change after execution of the instruction.
 ** "0/1" means that either "0" or "1" may be selected.



▪ **BRANCH**

ROM is accessed according to the program counter sequence and the program is executed. In order to jump to any address out of the sequence, there are four ways. They are explained in the following paragraphs.

● **BR**

By BR instruction, the program branches to an address in the current page.

The lower 6 bits of ROM Object Code (operand a, O_6 to O_1) are transferred to the address part of the program counter. This instruction is a conditional instruction and executed only when the Status F/F is "1". If it is "0", the instruction is skipped and the Status F/F becomes "1". The operation is shown in Figure 6.

● **LPU**

By LPU instruction, a jump between the bank and page is performed.

The lower 5 bits of the ROM Object Code (operand u, O_5 to O_1) are transferred to the page part of the program counter with a delay of 1-cycle time. At the same time, the signal $\overline{R_{70}}$ (the reversed-phase signal of the Data I/O Register R_{70}) is transferred to the bank part of the program counter with a delay of 1-cycle time. The operation is shown in Figure 7.

Consequently, the bank and page will remain unchanged in the cycle immediately following this instruction. In the next cycle, a jump between the bank and page is achieved.

This instruction (LPU) is conditional, and is executed only when the Status F/F is "1". Even after a skip, the Status F/F will remain unchanged ("0").

LPU instruction is used in combination with BR instruction or CAL instruction as the macro instruction of BRL or CALL instruction.

● **BRL**

By BRL instruction, the program branches to an address in any bank and page.

This instruction is a macro instruction of LPU and BR instructions, which is divided into two instructions as follows.

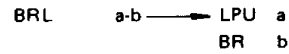

< Jump to Bank " $\overline{R_{70}}$ ", Page a - Address b >

BRL instruction is a conditional instruction because of its characteristics of LPU and BR instructions, and is executed only when the Status F/F is "1". If the Status F/F is "0", the instruction is skipped and the Status F/F becomes "1". The examples of BRL instruction are shown in Figure 8.

● **TBR (Table Branch)**

By TBR instruction, the program branches referring to the table.

The program counter is modified with the accumulator, the B register, the Carry F/F and the operand p.

The method for modification is shown in Figure 9.

The bank part is determined by the logical equation: $PC_{11} + p_2$, as shown in Table 4.

If the address where TBR instruction exists is in the Bank 1, it is possible to jump to an address only in the Bank 1, not to an address in the Bank 0.

If the address where TBR instruction exists is in the Bank 0, it is possible to jump to an address in either the Bank 1 or the Bank 0 depending on the value of the operand p_2 .

TBR instruction is executed regardless of the Status F/F, and does not affect the Status F/F.

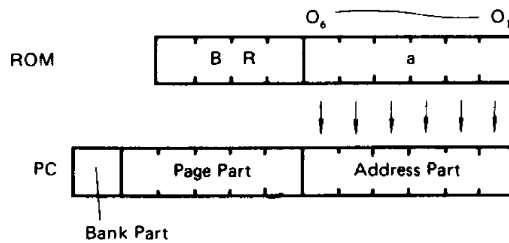

Figure 6 BR Operation

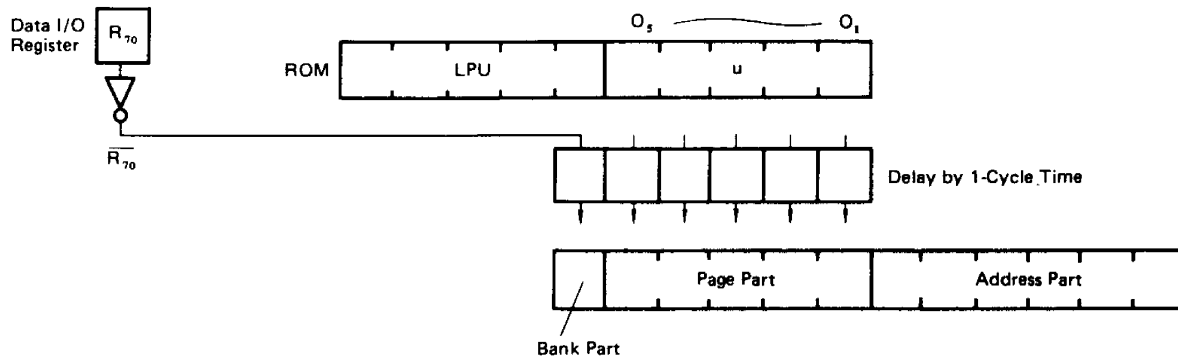

Figure 7 LPU Operation



```

Branch to Bank 0
LAI 15
LRA 7 } R70 = "1" (R̄70 = "0")
LPU 5 } BRL 5-3F
BR 3F } (Branch to Bank 0 5-3F (5-3F))

LAI 15
LBA 7 } R70 = "1" (R̄70 = "0")
LRA 7 }
COMB 31 } BRL 31-3F
LPU 31 } (Branch to Bank 0 31-3F (31-3F))
BR 3F }

Branch to Bank 1
LAI 0
LRA 7 } R70 = "0" (R̄70 = "1")
LPU 15 } BRL 15-3F
BR 3F } (Branch to Bank 1 15-3F (47-3F))

LAI 0
LTA 7 } R70 = "0" (R̄70 = "1")
LYI 2 }
XMA 10 } BRL 10-2E
LPU 10 } (Branch to Bank 1 10-2E (42-2E))
BR 2E }
    
```

Figure 8 BRL Example

Table 4 Bank Part Truth Table of TBR Instruction

PC ₁₁	P ₂	Bank Part of PC after TBR
1 (Bank 1)	1	1 (Bank 1)
	0	1 (Bank 1)
0 (Bank 0)	1	1 (Bank 1)
	0	0 (Bank 0)

■ SUBROUTINE JUMP

There are two types of subroutine jumps. They are explained in the following paragraphs.

● CAL

By CAL instruction, subroutine jump to the Subroutine Space is performed.

The Subroutine Space is the Bank 0 Page 0 (Page 0).

The address next to CAL instruction address is pushed onto the Stack ST1 and the contents of the stacks ST1, ST2 and ST3 are pushed onto the stacks ST2, ST3 and ST4 respectively as shown in Figure 10.

The bank part of the program counter becomes the Bank 0 and the page part becomes the Page 0. The lower 6 bits (operand a, O₆ to O₁) of the ROM Object Code are transferred to the address part of the program counter.

The HMCS47C has 4 levels of stack (ST1, ST2, ST3 and ST4) which allows the programmer to use up to 4 levels of subroutine jumps (including interrupts).

CAL is a conditional instruction and executed only when the Status F/F is "1". If the Status F/F is "0", it is skipped and the Status F/F changes to "1".

● CALL

By CALL instruction, subroutine jump to an address in any bank and page is performed.

Subroutine jump to any address can be implemented by the subroutine jump to the page specified by LPU instruction in the bank designated by the reversed-phase signal R̄₇₀ of the Data I/O Register R₇₀.

This instruction is a macro instruction of LPU and CAL instructions, which is divided into two steps as follows.

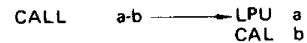

< Subroutine Jump to Bank "R̄₇₀", Page a - Address b >

CALL instruction is conditional because of characteristics of LPU and CAL instructions and is executed when the Status F/F is "1". If the Status F/F is "0", the instruction is skipped and the Status F/F changes to "1". The examples of CALL instruction are shown in Figure 11.

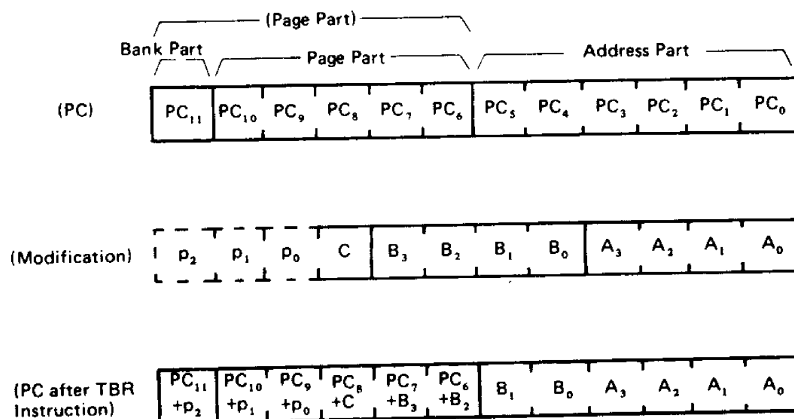

Figure 9 Modification of Program Counter by TBR Instruction



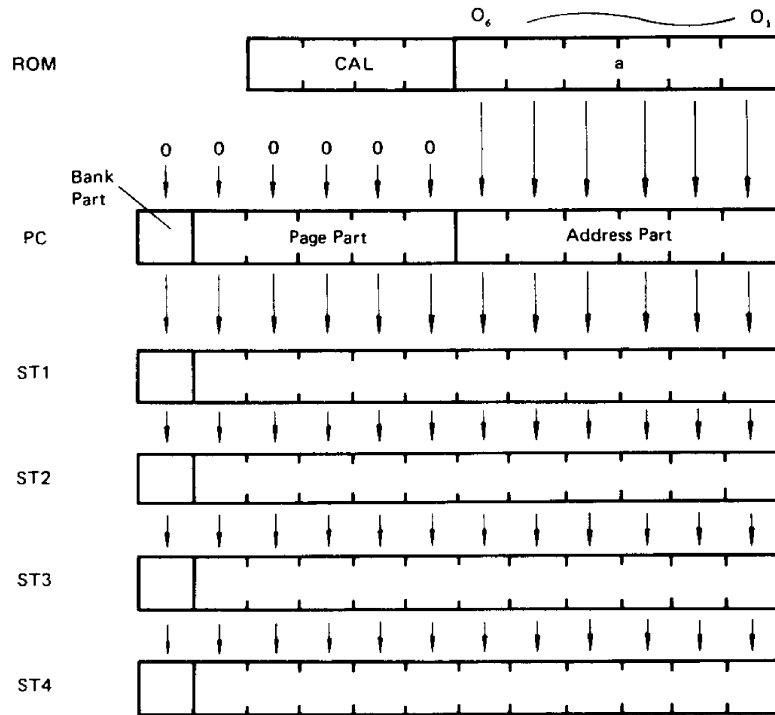

Figure 10 Subroutine Jump Stacking Order

```

Subroutine Jump to Bank 0
· LAI 15
· LRA 7      R70 = "1" (R̄70 = "0")
· LPU 5 }    CALL 5-3F
· CAL 3F }    (Subroutine Jump to Bank 0 5-3F (5-3F))

· LAI 15
· LBA
· LRA 7      R70 = "1" (R̄70 = "0")
· COMB
· LPU 31 }   CALL 3-3F
· CAL 3F }   (Subroutine Jump to Bank 0 31-3F (31-3F))

Subroutine Jump to Bank 1
· LAI 0
· LRA 7      R70 = "0" (R̄70 = "1")
· LPU 15 }   CALL 15-3F
· CAL 3F }   (Subroutine Jump to Bank 1 15-3F (47-3F))

· LAI 0
· LTA
· LRA 7      R70 = "0" (R̄70 = "1")
· LYI 3
· XMA
· LPU 10 }   CALL 10-2E
· CAL 2E }   (Subroutine Jump to Bank 1 10-2E (42-2E))
    
```

Figure 11 CALL Example

■ RAM

RAM is a memory used for storing data and saving the contents of the registers. Its capacity is 256 digits (1,024 bits) where one digit consists of 4 bits.

Addressing of RAM is performed by a matrix of the file No. and the digit No.

The file No. is set in the X register and the digit No. in the Y register for reading, writing or testing. Specific digits in RAM can be addressed not via the X register and Y register. These digits, 16 digits (MR0 to MR15), are called "Memory Register (MR)." The memory register can be exchanged with the accumulator by XAMR instruction.

The RAM address space is shown in Figure 12.

If an instruction consists of a simultaneous read/write operation of RAM (exchange between the contents of RAM and those of the register), the writing data doesn't affect the reading data because the read operation precedes the write operation.

The RAM bit manipulation instruction enables any addressed RAM bit to be set, reset or tested. The bit assignment is specified by the operand n of the instruction.

The bit test makes the Status F/F "1" when the assigned bit is "1" and makes it "0" when the assigned bit is "0"

Correspondence between the RAM bit and the operand n is shown in Figure 13.



■ REGISTER

The HMCS47C has six 4-bit registers and two 1-bit registers available to the programmer. The 1-bit registers are the Carry F/F and the Status F/F. They are explained in the following paragraphs.

● Status F/F (S)

The Status F/F latches the result of logical or arithmetic operations (Not Zero, Overflow) and bit test operations. The Status F/F affects conditional instructions (LPU, BR and CAL instructions). These instructions are executed only when the Status F/F is "1". If it is "0", these instructions are skipped and the Status F/F becomes "1".

● Accumulator (A; A Register) and Carry F/F (C)

The result of the Arithmetic Logic Unit (ALU) operation (4 bits) and the overflow of the ALU are loaded into the accumulator and the Carry F/F respectively. The Carry F/F can be set, reset or tested. Combination of the accumulator and the Carry F/F can be right or left rotated. The accumulator is the main register for ALU operation and the Carry F/F is used to store the overflow generated by ALU operation when the calculation of two or more digits (4 bits/digit) is performed.

● B Register (B)

The result of ALU operation (4 bits) is loaded into this register. The B register is used as a sub-accumulator to stack data temporarily and also used as a counter.

● X Register (X)

The result of ALU operation (4 bits) is loaded into this register. The X register is exchangeable with the SPX register, and addresses the RAM file.

● SPX Register (SPX)

The SPX register is exchangeable with the X register.

The SPX register is used to stack the contents of the X register and expand the addressing system of RAM in combination with the X register.

● Y Register (Y)

The result of ALU operation (4 bits) is loaded into this register. The Y register is exchangeable with the SPY register. The Y register can calculate itself simultaneously with transferring data by the bus lines, which is usable for the calculation of two or more digits (4 bits/digit). The Y register addresses the RAM digits and 1-bit Discrete I/Os.

● SPY Register (SPY)

The SPY register is exchangeable with the Y register. The SPY register is used to stack the contents of the Y register and expand the addressing system of RAM and 1-bit Discrete I/O in combination with the Y register.

■ INPUT/OUTPUT

● 4-bit Data Input/Output Common Channel (R)

The HMCS47C has six 4-bit Data I/O Common Channels (R0, R1, R2, R3, R4 and R5) and one 4-bit Data Output Channel (R6).

The 4-bit registers (Data I/O Register) are attached to these channels.

Each channel is directly addressed by the operand p of input/output instruction.

The data is transferred from the accumulator and the B register to the Data I/O Registers R0 to R6 via the bus lines.

ROM bit patterns are loaded into the Data I/O Register R2 and R3 by the pattern instruction.

The input instruction inputs the 4-bit data into the accumulator and the B register through the channels R0 to R3. Note that, since the Data I/O Register's output is directly connected to the pin even during execution of input instruction, the input data is wired logic of the Data I/O Register's output and the pin input. Therefore, the Data I/O Register should be set to 15 (all bits of the Data I/O Register is "1") not to affect the pin input before execution of input instruction, and Open Drain or With Pull up MOS should be specified for the I/O configuration of these pins.

The block diagram is shown in Figure 14 and the I/O timing is in Figure 15.

● 1-bit Discrete Input/Output Common Pin (D)

The HMCS47C has sixteen 1-bit Discrete I/O Common Pins.

The 1-bit Discrete I/O Common Pin consists of a 1-bit latch and an I/O common pin.

The 1-bit Discrete I/O is addressed by the Y register. The addressed latch can be set or reset by output instruction and level ("0" or "1") of the addressed pin can be tested by an input instruction.

Note that, since the latch output is directly connected to the pin even during execution of input instruction, the input data is wired logic of the latch's output and the pin input. Therefore, the latch should be set to "1" not to affect the pin input before execution of input instruction and Open Drain or With Pull up MOS should be specified for the I/O configuration of this pin.

The D₀ to D₃ pins are also addressed directly by the operand n of input/output instruction and can be set or reset. The block diagram is shown in Figure 16 and the I/O timing is shown in Figure 17.

● I/O Configuration

The I/O configuration of each pin can be specified among Open Drain, With Pull up MOS and CMOS using a mask option as shown in Figure 18.



(a) R0 to R5

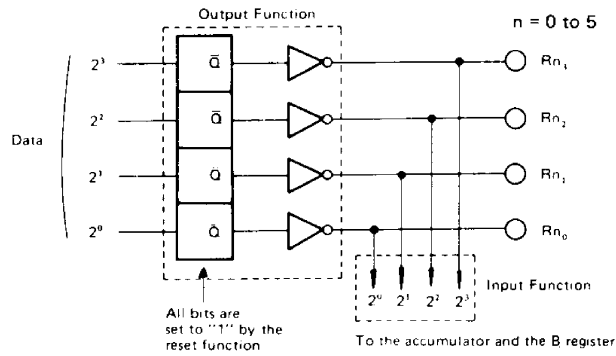

(b) R6

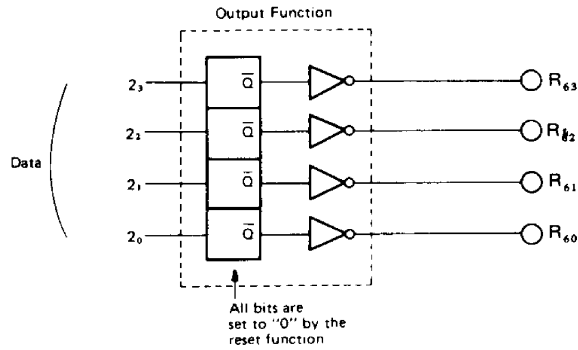

Figure 14 4-bit Data I/O Block Diagram

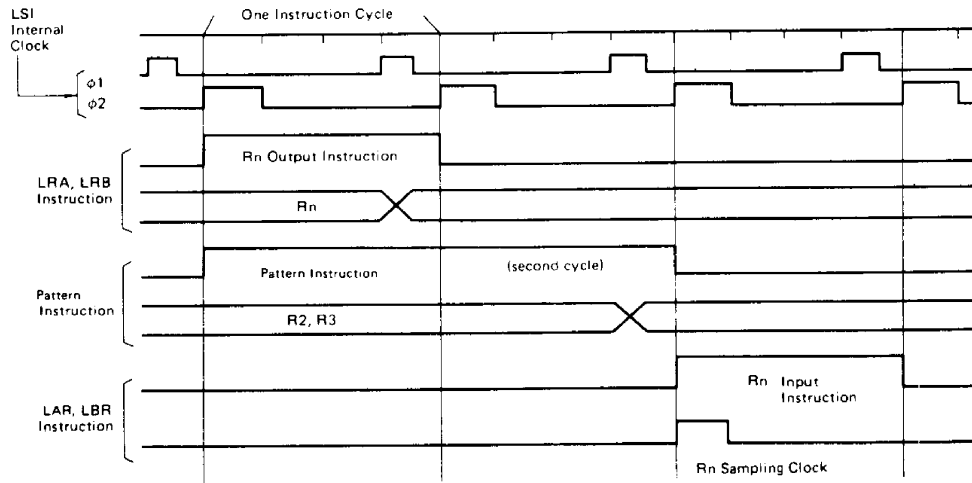

Figure 15 4-bit Data I/O Timing

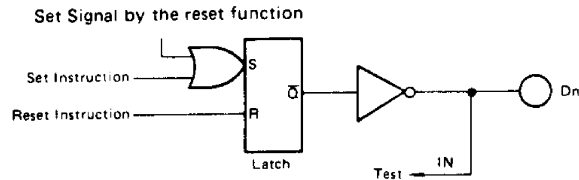

Figure 16 1-bit Discrete I/O Block Diagram



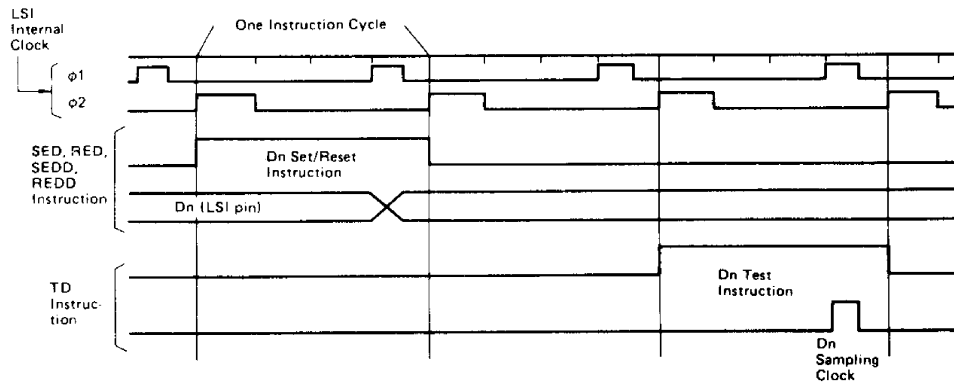
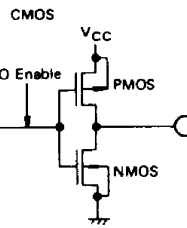
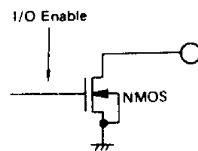

Figure 17 1-bit Discrete I/O Timing

(a) Configuration of Output Pin

Applied Pins: R₆₀ to R₆₃

No Pull up MOS (Open Drain)



(b) Configuration of I/O Pin

Applied pins: D₀ to D₁₅, R₀₀ to R₀₃, R₁₀ to R₁₃, R₂₀ to R₂₃, R₃₀ to R₃₃, R₄₀ to R₄₃, R₅₀ to R₅₃

No Pull up MOS (Open Drain)

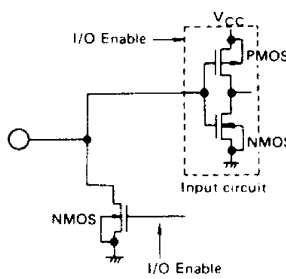

With Pull up MOS (PMOS)

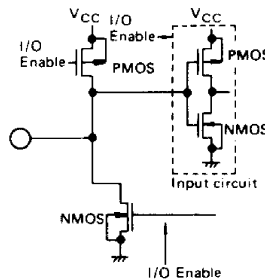

CMOS

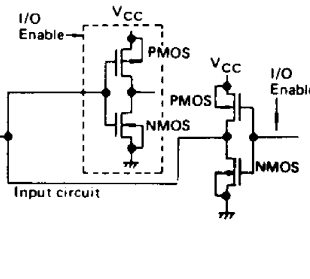

* When "Disable" is specified for the I/O State at the Halt State, the I/O Enable signal shown in the figure turns off the input circuit, Pull up MOS and NMOS output and sets CMOS output to high impedance (PMOS, NMOS: OFF).

Figure 18 I/O Configuration

■ **TIMER/COUNTER**

The timer/counter consists of 4-bit counter and 6-bit prescaler as shown in Figure 19.

The counter operates in the Timer Mode or Counter Mode according to the counting object. In the timer mode it counts overflow output pulse from the prescaler, and in the Counter Mode it counts INT₁ input pulse (counts leading edge), and increments to 15. Mode selection is determined according to the state of the CF. When the counter reaches zero (returns from 15), overflow output pulse is generated and the counter continues to count (14 → 15 → 0 → 1 →).

The relation between the specified value of the counter and specified time in the Timer Mode is shown in Table 5.

The prescaler is a 6-bit frequency divider. It generates 100/64

kHz pulses by dividing the system clock by 64. The prescaler is cleared when the data is loaded into the 4-bit counter by LTA, LTI instructions. The frequency division is 0 when the prescaler is cleared. At the 64th clock, an overflow output pulse is generated from the prescaler. During operation of the LSI, the prescaler operates and cannot be stopped.

The CF is the flip-flop (F/F) which controls the counter input. When the CF F/F is "1", input pulse of INT₁ is input to the counter (Counter Mode). When the CF is "0", prescaler overflow output pulse is input to the counter (Timer Mode).

The TF is the flip-flop (F/F) which masks the interrupt request from the timer/counter. It is set, reset and tested by instructions. If the overflow output pulse of the counter is



generated when the TF F/F is "0", an interrupt request occurs and the TF F/F becomes "1". If the overflow output pulse is generated when the TF F/F is "1", no interrupt request occurs. So it can be used as timer/counter interrupt mask.

The pulse width of INT₁ in the Counter Mode should be two or more cycles both at "High" and "Low" levels as shown in Figure 19.

■ INTERRUPT

The HMCS47C can be interrupted in two different ways: through the external interrupt input pins (INT₀, INT₁) and the timer/counter interrupt request. When any interrupt occurs, processing is suspended, the Status F/F is unchanged, the contents of the present program counter is pushed onto the stack ST1 and the contents of the stacks ST1, ST2 and ST3 are pushed onto the stacks ST2, ST3 and ST4 respectively. At that time, the Interrupt Enable F/F (I/E) is set and the address jumps to a fixed destination (Interrupt Address), and then the interrupt routine is executed. Stacking the registers other than the program counter must be performed by the program. The interrupt

routine must end with RTNI (Return Interrupt) instruction which sets the I/E F/F simultaneously with RTN instruction.

The Interrupt Address:

Input Interrupt Address Bank 0 Page 1 Address 3F
(Page 1 Address 3F)

Timer/Counter Interrupt Address Bank 0 Page 0
Address 3F
(Page 0 Address 3F)

The input interrupt has priority over the timer/counter interrupt.

The INT₀ and INT₁ pins have interrupt request functions. Each pin consists of a circuit which generates leading pulse and the Interrupt mask F/F (IF0, IF1). An interrupt is enabled (unmasked) when the IF0 F/F or IF1 F/F is reset. When the INT₀ or INT₁ pin changes from "0" to "1" (from "Low" level to "High" level), a leading pulse is generated to produce an interrupt request. At the same time, the IF0 F/F or IF1 F/F is set. When the IF0 F/F or IF1 F/F is set, it is an interrupt mask for the INT₀ or INT₁. (If a leading pulse is generated, no interrupt request occurs.)

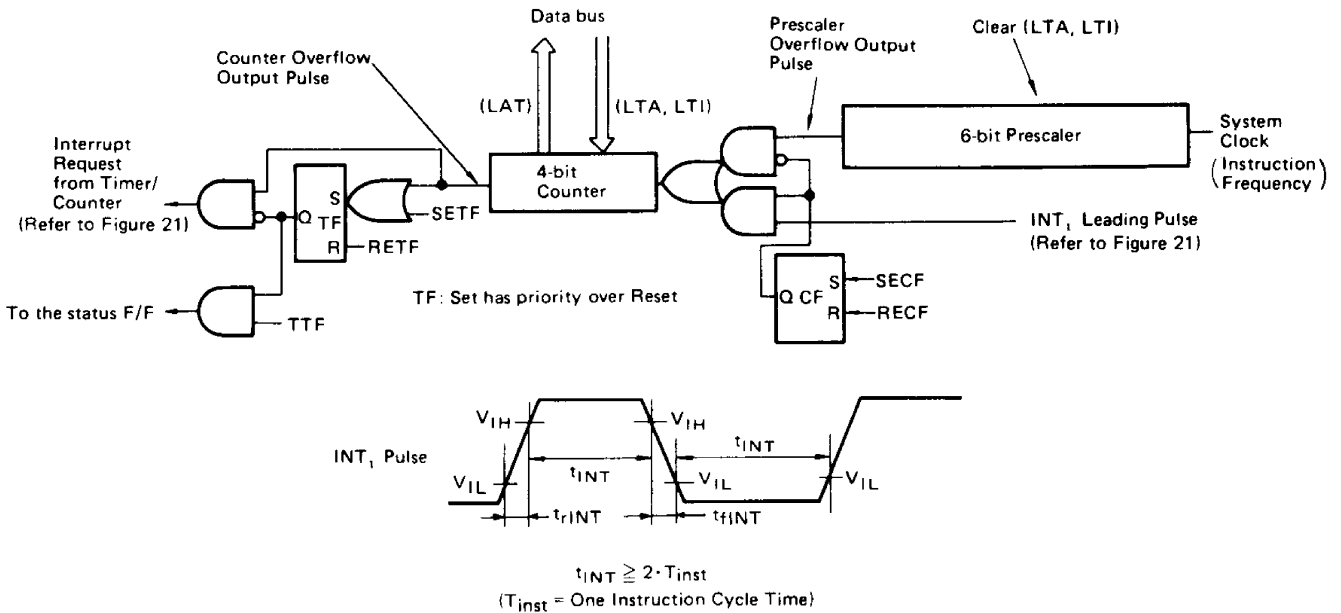

Figure 19 Timer/Counter Block Diagram

Table 5 Timer Range

Specified Value	Cycles	*Time (ms)	Specified Value	Cycles	*Time (ms)
0	1024	5.12	8	512	2.56
1	960	4.80	9	448	2.24
2	896	4.48	10	384	1.92
3	832	4.16	11	320	1.60
4	768	3.84	12	256	1.28
5	704	3.52	13	192	0.96
6	640	3.20	14	128	0.64
7	576	2.88	15	64	0.32

* Time is based on instruction frequency 200kHz. (One Instruction Cycle Time (T_{inst}) = 5μs)



An interrupt request generated by the leading pulse is latched into the input interrupt request F/F (I/RI) on the input side. If the Interrupt Enable F/F (I/E) is "1" (Interrupt Enable State), an interrupt occurs immediately and the I/RI F/F and the I/E F/F are reset. If the I/E F/F is "0" (Interrupt Disable State), the I/RI F/F is held at "1" until the HMCS47C gets into the Interrupt Enable State.

The IFO F/F, the IF1 F/F, the INT₀ pin and the INT₁ pin can be tested by interrupt instruction. Therefore, the INT₀ and the INT₁ can be used as additional input pins with latches.

The INT₀ pin and INT₁ pin can be provided with Pull up MOS using a mask option as shown in Figure 20.

An interrupt request from the timer/counter is latched into the timer interrupt request F/F (I/RT). The succeeding operations are same as an interrupt from the input. Only the exception is that, since an interrupt from the input precedes a timer/counter interrupt, the input interrupt occurs if both the I/RI F/F and the I/RT F/F are "1" (when the input interrupt and the timer/counter interrupts are generated simultaneously). During this processing, the I/RT F/F remains "1". The timer/counter interrupt can be implemented after the input interrupt servicing is achieved.

The interrupt circuit block diagram is shown in Figure 21.

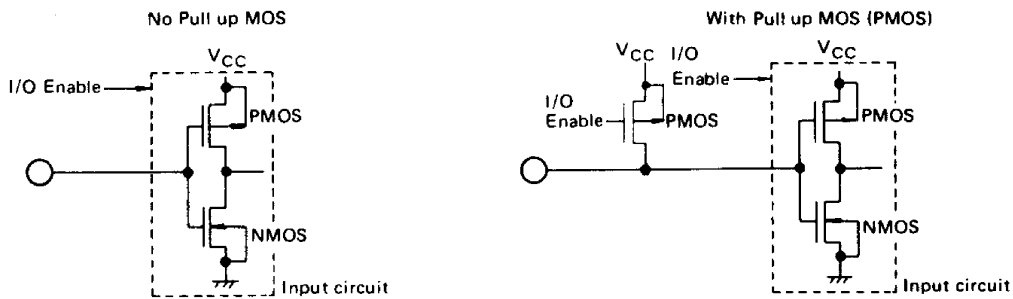

* When "Disable" is specified for the I/O State at the Halt State, the I/O Enable signal shown in the figure turns off the input circuit and Pull up MOS.

Figure 20 Configuration of INT₀ and INT₁

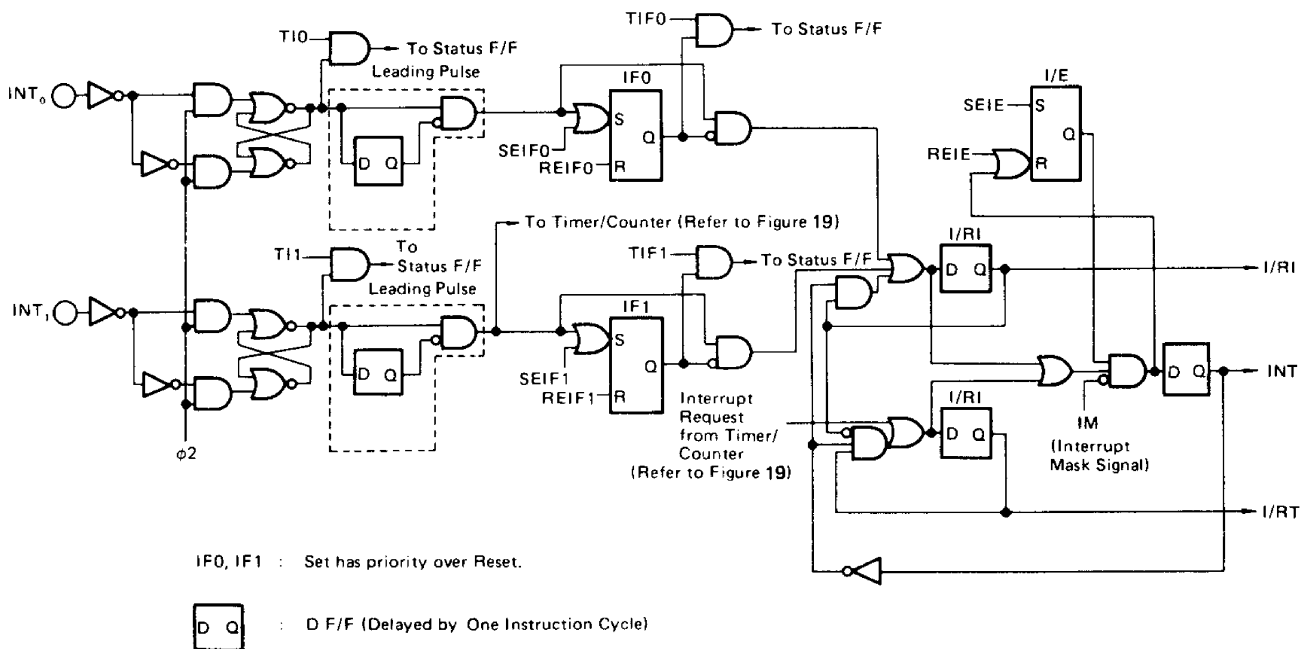

Figure 21 Interrupt Circuit Block Diagram



■ RESET FUNCTION

The reset is performed by setting the RESET pin to "1" ("High" level) and the HMCS47C gets into operation by setting it to "0" ("Low" level); Refer to Figure 22. Moreover, the HMCS47C has the power-on reset function (ACL; Built-in Reset Circuit). The Built-in Reset Circuit restricts the rise condition of the power supply; Refer to Figure 23. When the Built-in Reset Circuit is used, RESET should be connected to GND.

HMCS47CL doesn't have the power-on reset function.

Internal state of the HMCS47C is specified as follows by the reset function.

- Program Counter (PC) is set to Bank 1 Page 31 Address 3F (Page 63 Address 3F).
- Data I/O Register R₇₀ is set to "1" (Jumps to Bank 0 by execution of LPU instruction after the reset).
- I/RI, I/RT, I/E and CF are reset to "0"
- IF0, IF1, and TF are set to "1"
- Data I/O Registers (R0 to R6) and Discrete I/O Latches (D₀ to D₁₅) are all set to "1"

Note that all the other logic blocks (the Stack Registers, the Status F/F, the accumulator, the Carry F/F, the registers, the Timer/Counter, RAM) are not cleared by the reset function. The user should initialize these blocks by software. Because the Status F/F after the reset is not defined, set the Status F/F to "0" or "1" before the first execution of the conditional instructions (LPU, CAL and BR instructions).

■ HALT FUNCTION

When the HLT pin is set to "0" ("Low" level), the internal clock stops and all the internal statuses (RAM, the Registers, the Carry F/F, the Status F/F, the Program Counter, etc.) are held. Because all internal logic operations stop in this state, power consumption is reduced. There are two input/output statuses in the Halt State. The user should specify either "Enable" or "Disable" using a mask option at ROM ordering.

"Enable" — Output The status before the Halt State is held.
 Pull up MOS . . . ON
 Input Independent of the Halt State or Operating State (Input Circuit is ON)

Since Pull up MOS is ON, Pull up MOS current flows when output is "0" ("Low" level) in the Halt State (NMOS; ON). When an input signal changes, transition current flows into an input circuit. Also, current flows into Pull up MOS. These currents are added to the Stand-by Supply Current (or Halt Current).

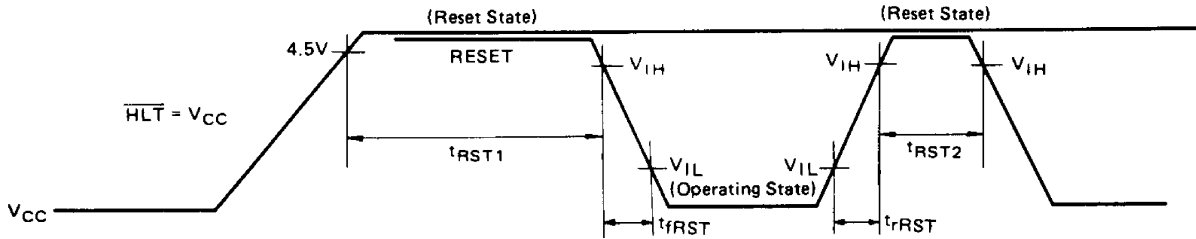

* t_{RST1} includes the time required from the power ON until the operation gets into the constant state.
 ** t_{RST2} is applied when the operation is in the constant state.

Figure 22 RESET Timing

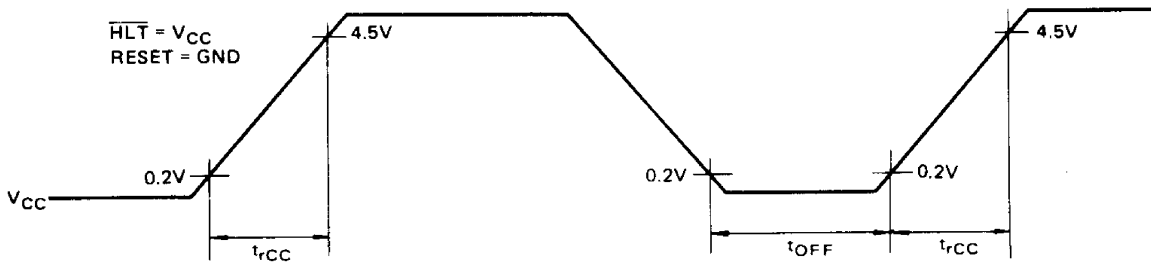

* t_{OFF} specifies the period when the power supply is OFF in the case that a short break of the power supply occurs and the power supply ON/OFF is repeated.

Figure 23 Power Supply Timing for Built-in Reset Circuit



“Disable”

- Output NMOS Output: OFF
CMOS Output:
High Impedance
(NMOS, PMOS:
OFF)
- Pull up MOS . . . OFF
- Input Input Circuit: OFF

Both input and output are at high impedance state. Since an input circuit is OFF, only the Standby Supply Current (or Halt Current) flows even if an input signal changes.

When the $\overline{\text{HLT}}$ pin is set to “1” (“High” level), the HMCS47C gets into operation from the status just before the Halt State. The halt timing is shown in Figure 24.

■ OSCILLATOR

The HMCS47C contains its own oscillator and frequency divider (CPG). The user can obtain the desired timing for operation of the LSI by merely connecting an resistor R_f or ceramic filter circuit (Internal Clock Operation). Also an external oscillator can supply a clock (External Clock Operation).

The OSC_1 clock frequency is internally divided by four to produce the internal system clocks.

The user may exchange the external parts for the same LSI to select either of these two operational modes as shown in Figure 26. There is no need of specifying it by using the mask option.

The typical value of clock oscillation frequency (f_{osc}) varies with a oscillation resistor R_f as shown in Figure 27.

CAUTION

If, during the Halt State, the external reset input is applied (RESET = “1” (“High” level)), the internal status is not held.

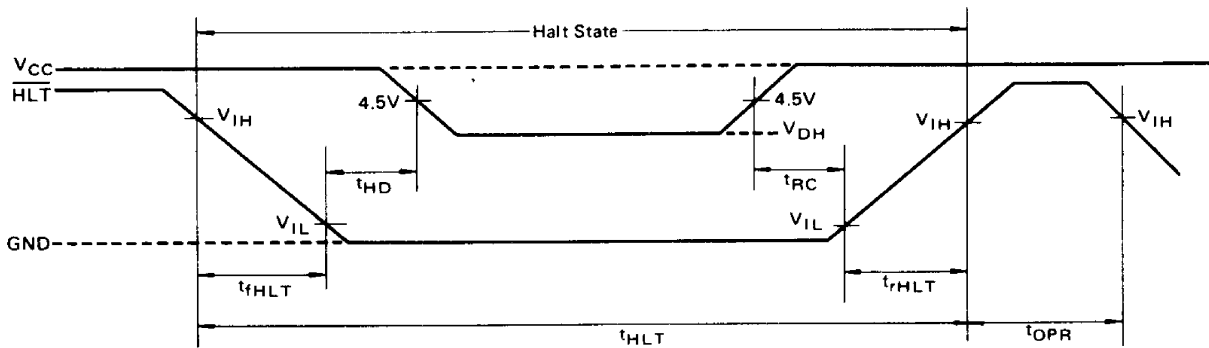

Figure 24 Halt Timing

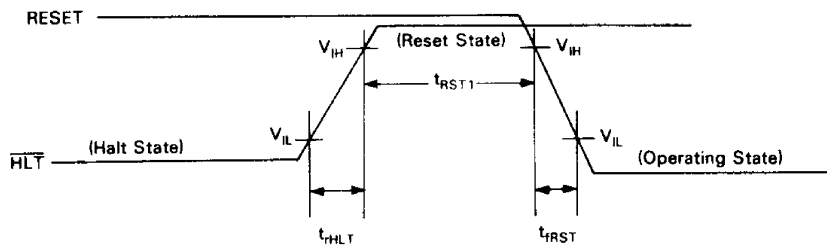
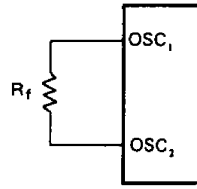

Figure 25 RESET Timing when Releasing Halt (Ceramic Filter Oscillation)



(a) Internal Clock Operation Using Resistor R_f



Wiring of OSC₁ and OSC₂ pins should be as short as possible because the oscillation frequency is modified by capacitance of these pins.

(b) Internal Clock Operation Using Ceramic Filter Circuit (This is not applied to HMCS47CL.)

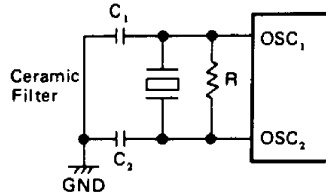

Ceramic Filter; CSB800A (MURATA)
 R_1 : $1M\Omega \pm 10\%$
 C_1 : $150pF \pm 10\%$ (Ceramic Capacitor)
 C_2 : $150pF \pm 10\%$ (Ceramic Capacitor)

Reset at the time of Halt releasing.
 This circuit is the example of the typical use. As the oscillation characteristics is not guaranteed, please consider and examine the circuit constants carefully on your application.

(c) External Clock Operation

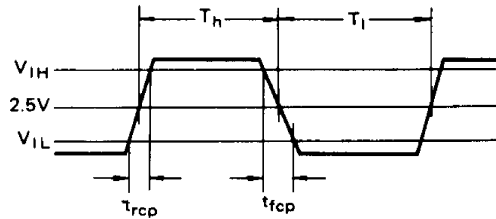
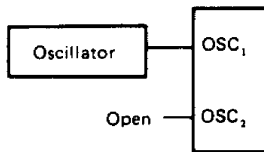

$$\text{Duty} = \frac{T_l}{T_h + T_l} \times 100\%$$

Figure 26 Clock Operation Mode

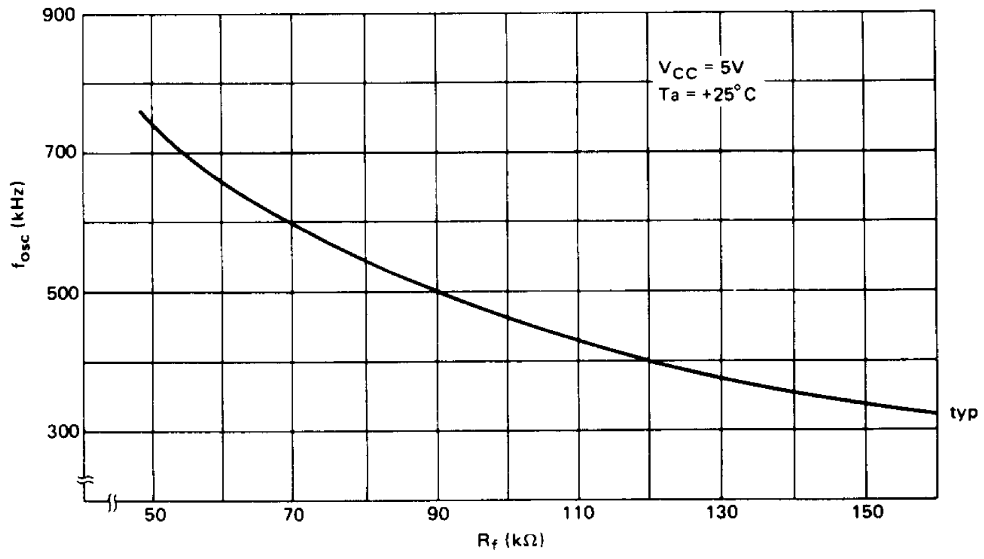

Figure 27 Typical Value of Oscillation Frequency vs. R_f



■ INSTRUCTION LIST

The instructions of the HMCS47C are listed according to their functions, as shown in Table 6 .

Table 6 Instruction List

Group	Mnemonic	Function	Status
Register - Register Instruction	LAB LBA LAY LASPX LASPY XAMR m	B → A A → B Y → A SPX → A SPY → A A ↔ MR (m)	
RAM Address Register Instruction	LXA LYA LXI i LYI i IY DY Ayy Syy XSPX XSPY XSPXY	A → X A → Y i → X i → Y Y+1 → Y Y-1 → Y Y+A → Y Y-A → Y X ↔ SPX Y ↔ SPY X ↔ SPX, Y ↔ SPY	NZ NB C NB
RAM - Register Instruction	LAM (XY) LBM (XY) XMA (XY) XMB (XY) LMAIY (X) LMADY (X)	M → A (XY ↔ SPXY) M → B (XY ↔ SPXY) M ↔ A (XY ↔ SPXY) M ↔ B (XY ↔ SPXY) A → M, Y+1 → Y (X ↔ SPX) A → M, Y-1 → Y (X ↔ SPX)	NZ NB
Immediate Transfer Instruction	LMIIY i LAI i LBI i	i → M, Y+1 → Y i → A i → B	NZ
Arithmetic Instruction	AI i IB DB AMC SMC AM DAA DAS NEGA COMB SEC REC TC ROTL ROTR OR	A+i → A B+1 → B B-1 → B M+A+C (F/F) → A M-A- \bar{C} (F/F) → A M+A → A Decimal Adjustment (Addition) Decimal Adjustment (Subtraction) $\bar{A}+1$ → A \bar{B} → B "1" → C (F/F) "0" → C (F/F) Test C (F/F) Rotation Left Rotation Right A ∪ B → A	C NZ NB C NB C C (F/F)

(to be continued)

Group	Mnemonic	Function	Status
Compare Instruction	MNEI i	M ≠ i	NZ
	YNEI i	Y ≠ i	NZ
	ANEM	A ≠ M	NZ
	BNEM	B ≠ M	NZ
	ALEI i	A < i	NB
	ALEM	A < M	NB
	BLEM	B < M	NB
RAM Bit Manipulation Instruction	SEM n	"1" → M (n)	M(n)
	REM n	"0" → M (n)	
	TM n	Test M (n)	
ROM Address Instruction	BR a	Branch on Status 1	1
	CAL a	Subroutine Jump on Status 1	1
	LPU u	Load Program Counter Upper on Status 1	
	TBR p	Table Branch	
	RTN	Return from Subroutine	
Interrupt Instruction	SEIE	"1" → I/E	INT ₀ INT ₁ IF0 IF1 TF
	SEIF0	"1" → IF0	
	SEIF1	"1" → IF1	
	SETF	"1" → TF	
	SECF	"1" → CF	
	REIE	"0" → I/E	
	REIF0	"0" → IF0	
	REIF1	"0" → IF1	
	RETF	"0" → TF	
	RECF	"0" → CF	
	Ti0	Test INT ₀	
	Ti1	Test INT ₁	
	TIF0	Test IF0	
	TIF1	Test IF1	
	TTF	Test TF	
	LTI i	i → Timer/Counter	
LTA	A → Timer/Counter		
LAT	Timer/Counter → A		
RTNI	Return Interrupt		
Input/Output Instruction	SED	"1" → D (Y)	D(Y)
	RED	"0" → D (Y)	
	TD	Test D (Y)	
	SEDD n	"1" → D (n)	
	REDD n	"0" → D (n)	
	LAR p	R(p) → A	
	LBR p	R(p) → B	
	LRA p	A → R (p)	
	LRB p	B → R (p)	
P p	Pattern Generation		
	NOP	No Operation	

[NOTE] 1. (XY) after a mnemonic code has four meanings as follows.

Mnemonic only	Instruction execution only
Mnemonic with X	After instruction execution, X ↔ SPX
Mnemonic with Y	After instruction execution, Y ↔ SPY
Mnemonic with XY	After instruction execution, X ↔ SPX, Y ↔ SPY

[Example] LAM M → A
 LAMX M → A, X ↔ SPX
 LAMY M → A, Y ↔ SPY
 LAMXY M → A, X ↔ SPX, Y ↔ SPY

2. Status column shows the factor which brings the Status F/F "1" under judgement instruction or instruction accompanying the judgement.

NZ ALU Not Zero
 C ALU Overflow in Addition, that is, Carry
 NB ALU Overflow in Subtraction, that is, No Borrow
 Except above Contents of the status column affects the Status F/F directly.

3. The Carry F/F (C(F/F)) is not always affected by executing the instruction which affects the Status F/F. Instructions which affect the Carry F/F are eight as follows.

AMC	SEC
SMC	REC
DAA	ROTL
DAS	ROTR

4. All instructions except the pattern instruction (P) are executed in 1-cycle. The pattern instruction (P) is executed in 2-cycle.



HMCS47C Mask Option List

<input type="checkbox"/> 5V Operation : HMCS47C
<input type="checkbox"/> 3V Operation : HMCS47CL

☆ Mark "✓" in "□" for the selected spec.

Date	
Customer	
Dept.	
Name	
ROM CODE ID	
LSI Type Name (entered by Hitachi)	

(1) I/O Option

Pin Name	I/O	I/O Option			Remarks	Pin Name	I/O	I/O Option			Remarks
		A	B	C				A	B	C	
D ₀	I/O					R ₀₀	I/O				
D ₁	I/O					R ₀₁	I/O				
D ₂	I/O					R ₀₂	I/O				
D ₃	I/O					R ₀₃	I/O				
D ₄	I/O					R ₁₀	I/O				
D ₅	I/O					R ₁₁	I/O				
D ₆	I/O					R ₁₂	I/O				
D ₇	I/O					R ₁₃	I/O				
D ₈	I/O					R ₂₀	I/O				
D ₉	I/O					R ₂₁	I/O				
D ₁₀	I/O					R ₂₂	I/O				
D ₁₁	I/O					R ₂₇	I/O				
D ₁₂	I/O					R ₃₀	I/O				
D ₁₃	I/O					R ₃₁	I/O				
D ₁₄	I/O					R ₃₂	I/O				
D ₁₅	I/O					R ₃₃	I/O				
						R ₄₀	I/O				
						R ₄₁	I/O				
						R ₄₂	I/O				
						R ₄₃	I/O				
						R ₅₀	I/O				
						R ₅₁	I/O				
						R ₅₂	I/O				
						R ₅₃	I/O				
						R ₆₀	O				
						R ₆₁	O				
						R ₆₂	O				
						R ₆₃	O				
INT ₀	I										
INT ₁	I										

☆ Specify the I/O composition with a mark of "O" in the applicable composition column.
 A. No pull up MOS B. With pull up MOS C. CMOS Output

(2) I/O State at "Halt" mode

I/O State	
<input type="checkbox"/> Enable	
<input type="checkbox"/> Disable	

☆ Mark "✓" in "□" for the selected I/O state.

(3) Package

Package	
<input type="checkbox"/> FP-54	
<input type="checkbox"/> DP-64S	

☆ Mark "✓" in "□" for the selected package.

Check List of Application

[A] Oscillator (CPG option)

CPG	5V Operation	3V Operation
Resistor	<input type="checkbox"/> Rf = 51kΩ ± 2%	<input type="checkbox"/> Rf = 200kΩ ± 2%
Ceramic Filter	<input type="checkbox"/> MURATA : CSB800A	
External Clock	<input type="checkbox"/> fcp = 350k to 850kHz	<input type="checkbox"/> fcp = 130k to 240 kHz

☆ Mark "✓" in "□" for the selected oscillator.

[B] Halt Function (Only when Ceramic Filter is selected in [A].)

Halt Mode	Using Ceramic Filter
	<input type="checkbox"/> Not used
	<input type="checkbox"/> Used (Recovery with Reset)

☆ Mark "✓" in "□" for the selected spec

