

HD74AC670/HD74ACT670 • 4 × 4 Register File with 3-State Output

Description

The HD74AC670/HD74ACT670 contains 16 high speed, low power, transparent D-type latches arranged as four words of four bits each, to function as a 4 × 4 register file. Separate read and write inputs, both address and enable, allow simultaneous read and write operation. The 3-state outputs make it possible to connect up to 128 outputs to increase the word capacity up to 512 words. Any number of these devices can be operated in parallel to generate an n-bit length.

- 3-State Outputs Drive Bus Lines or Buffer Memory Address Registers
- Outputs Source/Sink 24 mA
- HD74ACT670 have TTL-Compatible Inputs

Logic Symbol

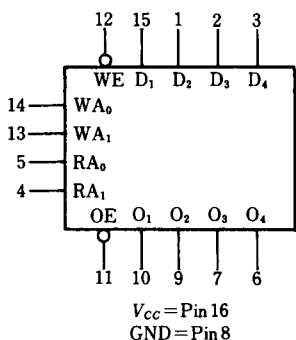

Pin Assignment

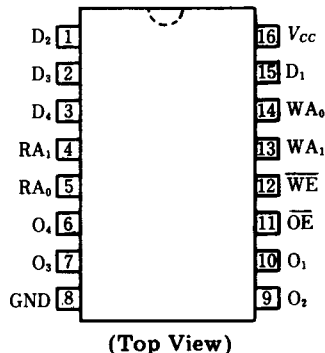

Pin Names

- D₁-D₄ Data Inputs
- WA₀, WA₁ Write Address Inputs
- WE Write Enable Input (Active Low)
- RA₀, RA₁ Read Address Inputs
- OE 3-State Output Enable Input (Active Low)
- O₁-O₄ Data Outputs

DataSheet4U.com

Write Function Table

Write Inputs			D Inputs to
WE	WA ₁	WA ₀	
L	L	L	Word 0
L	L	H	Word 1
L	H	L	Word 2
L	H	H	Word 3
H	X	X	None (hold)

Read Function Table

Read Inputs			Outputs from
OE	RA ₁	RA ₀	
L	L	L	Word 0
L	L	H	Word 1
L	H	L	Word 2
L	H	H	Word 3
H	X	X	None (HIGH Z)

H = High Voltage Level
L = Low Voltage Level
X = Immaterial

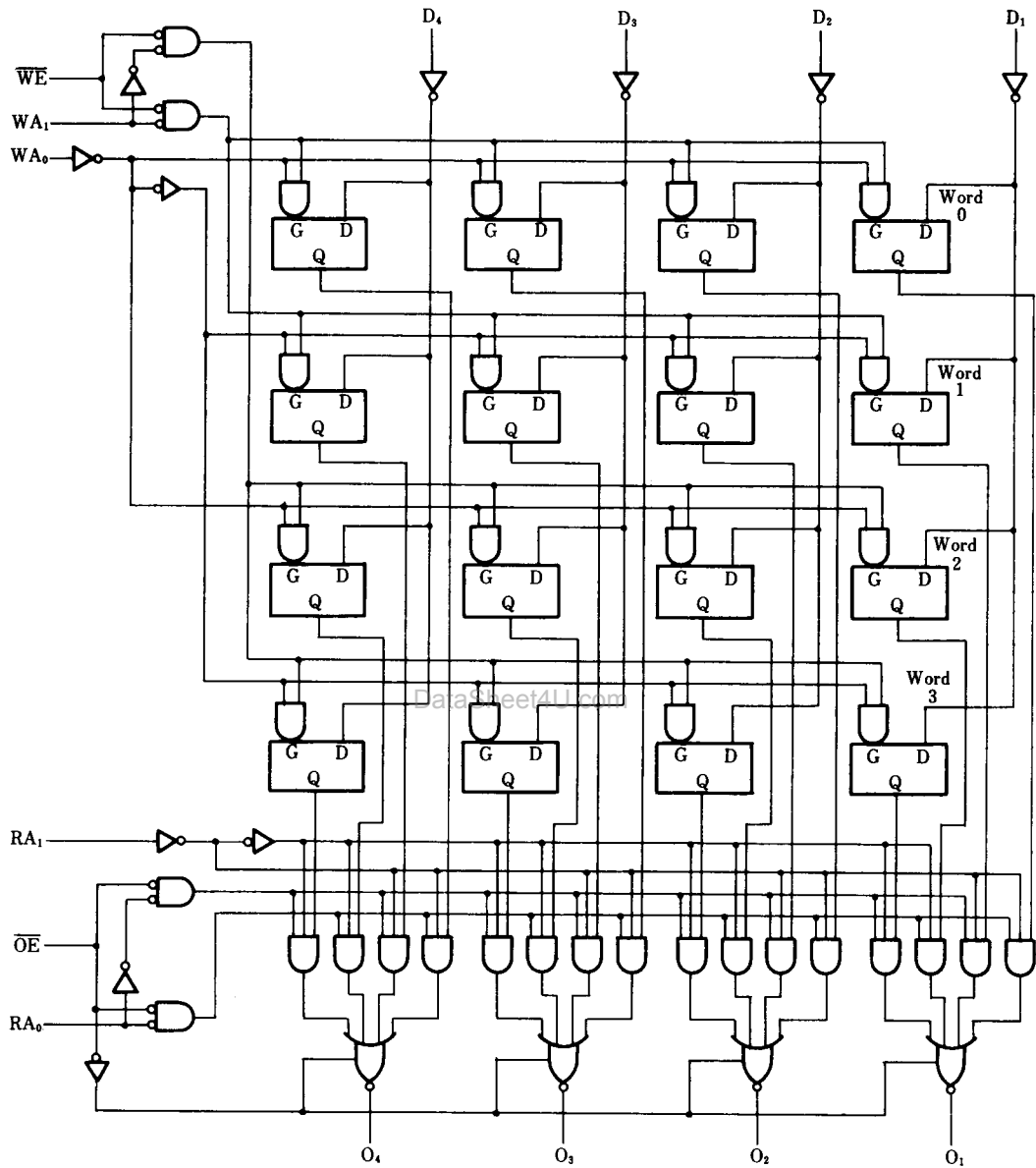
HD74AC670/HD74ACT670**Logic Diagram**

et4U.com

DataShee

DataSheet4U.com

HD74AC670/HD74ACT670

DC Characteristics (unless otherwise specified)

Symbol	Parameter	Max	Unit	Condition
I_{CC}	Maximum Quiescent Supply Current	80	μA	$V_{IN} = V_{CC}$ or Ground, $V_{CC} = 5.5V$, $T_a = \text{Worst Case}$
I_{CC}	Maximum Quiescent Supply Current	8.0	μA	$V_{IN} = V_{CC}$ or Ground, $V_{CC} = 5.5V$, $T_a = 25^\circ C$
$I_{CC(T)}$	Maximum I_{CC} /Input (HD74ACT670)	1.5	mA	$V_{IN} = V_{CC} - 2.1V$ $V_{CC} = 5.5V$, $T_a = \text{Worst Case}$

AC Characteristics : HD74AC670

Symbol	Parameter	V_{CC}^* (V)	$T_a = +25^\circ C$ $C_L = 50pF$			$T_a = -40^\circ C$ to $+85^\circ C$ $C_L = 50pF$		Unit
			Min	Typ	Max	Min	Max	
t_{PLH}	Propagation Delay \overline{W}_E to O_n	3.3	1.0	14.0	17.5	1.0	19.0	ns
		5.0	1.0	11.5	13.5	1.0	15.0	
t_{PHL}	Propagation Delay \overline{W}_E to O_n	3.3	1.0	13.5	17.0	1.0	18.5	ns
		5.0	1.0	11.0	13.0	1.0	14.5	
t_{PLH}	Propagation Delay R_{A1} or R_{A0} to O_n	3.3	1.0	12.5	15.5	1.0	17.0	ns
		5.0	1.0	10.0	12.0	1.0	13.0	
t_{PHL}	Propagation Delay R_{A1} or R_{A0} to O_n	3.3	1.0	12.5	15.5	1.0	17.0	ns
		5.0	1.0	10.0	12.0	1.0	13.0	
t_{PLH}	Propagation Delay Data to O_n	3.3	1.0	12.0	15.0	1.0	16.5	ns
		5.0	1.0	9.5	11.5	1.0	12.5	
t_{PHL}	Propagation Delay Data to O_n	3.3	1.0	11.5	14.5	1.0	16.0	ns
		5.0	1.0	9.0	11.0	1.0	12.0	
t_{PZH}	Enable Time \overline{OE} to O_n	3.3	1.0	8.0	11.0	1.0	12.0	ns
		5.0	1.0	6.0	8.5	1.0	9.5	
t_{PZL}	Enable Time \overline{OE} to O_n	3.3	1.0	10.0	12.0	1.0	13.0	ns
		5.0	1.0	7.5	9.5	1.0	10.5	
t_{PHZ}	Disable Time \overline{OE} to O_n	3.3	1.0	8.0	11.0	1.0	12.0	ns
		5.0	1.0	6.0	8.5	1.0	9.5	
t_{PLZ}	Disable Time \overline{OE} to O_n	3.3	1.0	9.0	11.5	1.0	12.5	ns
		5.0	1.0	7.0	9.0	1.0	10.0	

* Voltage Range 3.3 is $3.3V \pm 0.3V$
Voltage Range 5.0 is $5.0V \pm 0.5V$

AC Operating Requirements : HD74AC670

Symbol	Parameter	V_{CC}^* (V)	$T_a = +25^\circ C$ $C_L = 50pF$		$T_a = -40^\circ C$ to $+85^\circ C$ $C_L = 50pF$		Unit
			Typ	Guaranteed Minimum	Typ	Guaranteed Minimum	
t_{su}	Setup Time Data to \overline{W}_E	3.3	3.0	5.5	6.0	ns	
		5.0	2.0	4.0	4.5		
t_{th}	Hold Time \overline{W}_E to Data	3.3	3.0	4.0	4.0	ns	
		5.0	2.5	4.0	4.0		
t_w	Pulse Width \overline{W}_E	3.3	3.5	5.5	7.0	ns	
		5.0	2.5	4.5	5.0		
t_{latch}	Latch Width \overline{W}_E to 1	3.3	0.5	10.0	10.0	ns	
		5.0	0.5	10.0	10.0		

* Voltage Range 3.3 is $3.3V \pm 0.3V$
Voltage Range 5.0 is $5.0V \pm 0.5V$

HD74AC670/HD74ACT670

AC Characteristics : HD74ACT670

Preliminary

Symbol	Parameter	V _{CC} * (V)	T _a = +25°C C _L = 50pF			T _a = -40°C to +85°C C _L = 50pF		Unit
			Min	Typ	Max	Min	Max	
t _{PLH}	Propagation Delay W _E to O	5.0	1.0	13.0	15.5	1.0	16.5	ns
t _{PHL}	Propagation Delay W _E to O _i	5.0	1.0	13.0	15.5	1.0	16.5	ns
t _{PLH}	Propagation Delay R _{A1} or R _{A0} to O	5.0	1.0	13.0	15.5	1.0	16.5	ns
t _{PHL}	Propagation Delay R _{A1} or R _{A0} to O	5.0	1.0	11.0	13.5	1.0	14.5	ns
t _{PLH}	Propagation Delay Data to O	5.0	1.0	10.5	12.5	1.0	13.5	ns
t _{PHL}	Propagation Delay Data to O	5.0	1.0	11.0	13.0	1.0	14.0	ns
t _{PZH}	Enable Time OE to O	5.0	1.0	8.0	10.5	1.0	11.5	ns
t _{PZL}	Enable Time OE to O	5.0	1.0	9.5	11.5	1.0	12.5	ns
t _{PHZ}	Disable Time OE to O	5.0	1.0	7.0	9.5	1.0	10.5	ns
t _{PLZ}	Disable Time OE to O	5.0	1.0	7.5	10.0	1.0	11.0	ns

* Voltage Range 5.0 is 5.0V ± 0.5V

AC Operating Requirements : HD74ACT670

Preliminary

Symbol	Parameter	V _{CC} * (V)	T _a = +25°C C _L = 50pF		T _a = -40°C to +85°C C _L = 50pF		Unit
			Typ	Guaranteed Minimum			
t _{su}	Setup Time Data to W _E	5.0	2.5	7.0	8.0		ns
	Setup Time W _{A1} or W _{A0} to W _E	5.0	2.5	7.0	8.0		ns
t _h	Hold Time W _E to Data	5.0	2.5	4.0	4.0		ns
	Hold Time W _E to W _{A1} or W _{A2}	5.0	2.5	4.0	4.0		ns
t _w	Pulse Width W _E	5.0	4.5	7.0	8.0		ns
t _{latch}	Latch Time W _E to R _B	5.0	0.5	10.0	10.0		ns

* Voltage Range 5.0 is 5.0V ± 0.5V

Capacitance

Symbol	Parameter	Typ	Unit	Condition
C _{IN}	Input Capacitance	4.5	pF	V _{CC} = 5.5V
C _{PD}	Power Dissipation Capacitance	60	pF	V _{CC} = 5.0V

Package Information

In the HD74AC series of Advanced CMOS logic, either plastic DIP and small outline packages can be selected.
 To order, please refer to the following package code.

• Package code of Advanced CMOS Logic

HD74AC XXXX P

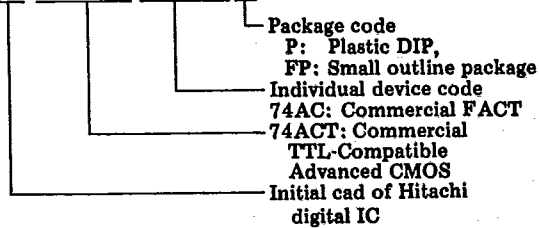

Plastic DIP Package [Unit: mm (inch)]

14 Pin type

16 Pin type

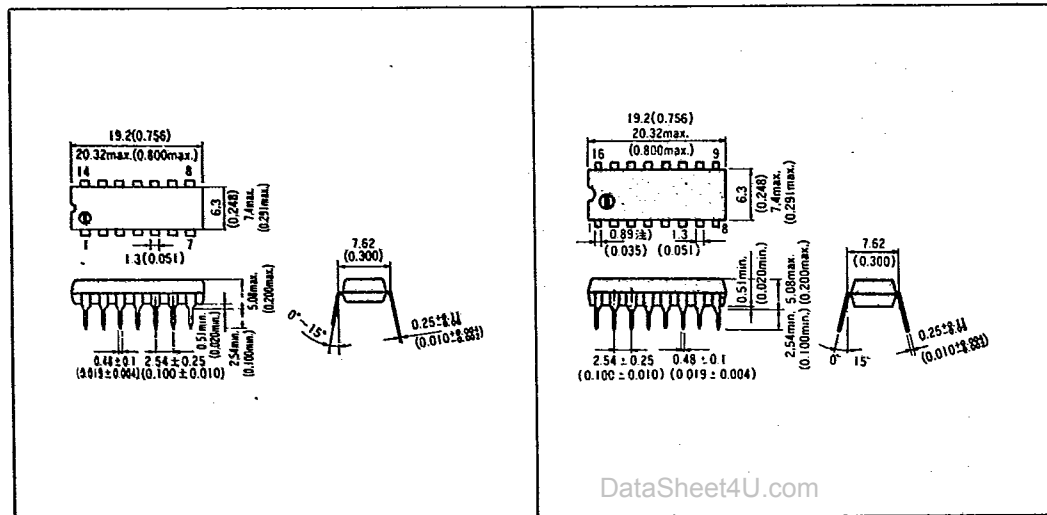

20 Pin type

24 Pin type

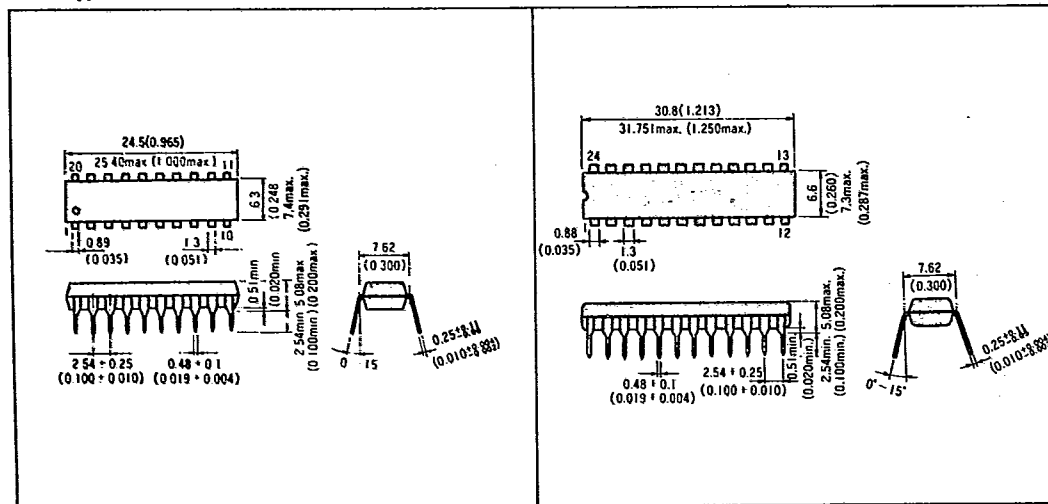

Package Information

Small Outline Package [Unit: mm (inch)]

14 Pin type

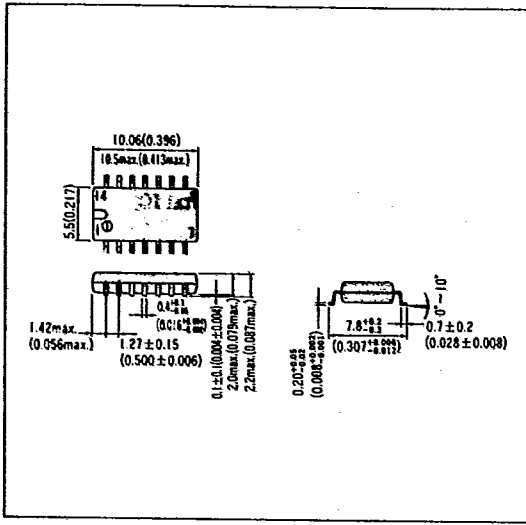

16 Pin type

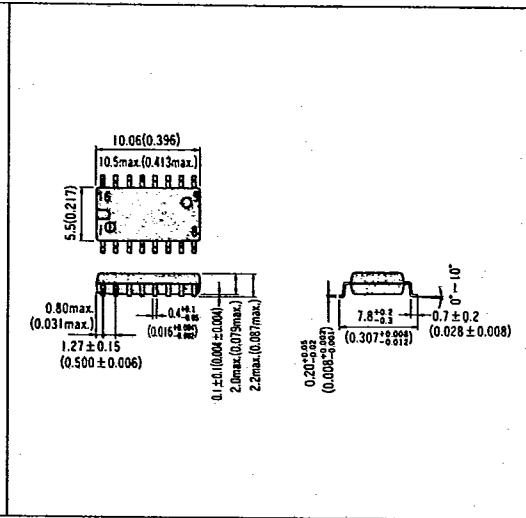

20 Pin type

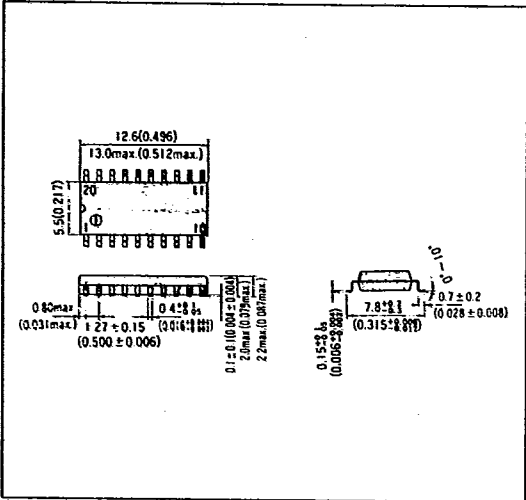

DataSheet4U.com