

---

# HD74HC108

Dual J-K Flip-Flops (with Preset, Common Clear and Common Clock)

# HITACHI

---

## Description





This flip-flop is edge sensitive to the clock input and change state on the negative transition of the clock pulse. Each flip-flop has independent J, K, and preset inputs and Q and  $\bar{Q}$  outputs. Two flip-flops are controlled by a common clear and a common clock. Preset and clear are independent of the clock and accomplished by a low logic level on the corresponding input.

## Features

- High Speed Operation:  $t_{pd}$  (Clock to Q) = 20 ns typ ( $C_L = 50$  pF)
- High Output Current: Fanout of 10 LSTTL Loads
- Wide Operating Voltage:  $V_{CC} = 2$  to 6 V
- Low Input Current: 1  $\mu$ A max
- Low Quiescent Supply Current:  $I_{CC}$  (static) = 2  $\mu$ A max ( $T_a = 25^\circ\text{C}$ )

# HD74HC108

## Function Table

Inputs					Output	
Preset	Clear	Clock	J	K	Q	$\bar{Q}$
L	H	X	X	X	H	L
H	L	X	X	X	L	H
L	L	X	X	X	H* <sup>1</sup>	H* <sup>1</sup>
H	H		L	L	No change	
H	H		L	H	L	H
H	H		H	L	H	L
H	H		H	H	Toggle	
H	H	L	X	X	No change	
H	H	H	X	X	No change	
H	H		X	X	No change	

Note: 1. Q and  $\bar{Q}$  will remain HIGH as long as preset and Clear are Low, but Q and  $\bar{Q}$  are unpredictable, if Preset and Clear go HIGH simultaneously.

## Pin Arrangement

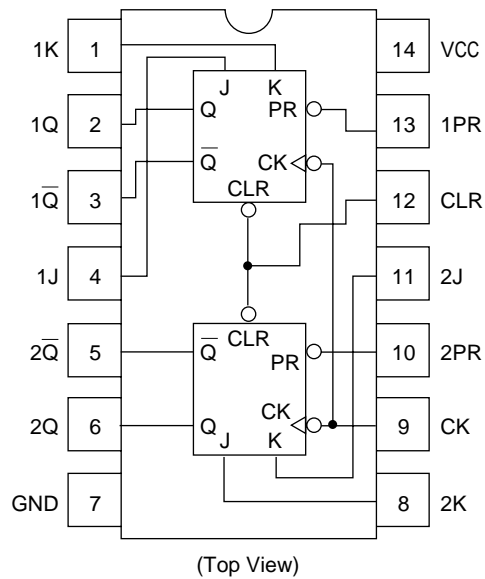

HITACHI

DC Characteristics

Item	Symbol	V <sub>CC</sub> (V)	Ta = 25°C			Ta = -40 to +85°C		Unit	Test Conditions	
			Min	Typ	Max	Min	Max			
Input voltage	V <sub>IH</sub>	2.0	1.5	—	—	1.5	—	V		
		4.5	3.15	—	—	3.15	—			
		6.0	4.2	—	—	4.2	—			
	V <sub>IL</sub>	2.0	—	—	0.5	—	0.5	V		
		4.5	—	—	1.35	—	1.35			
		6.0	—	—	1.8	—	1.8			
Output voltage	V <sub>OH</sub>	2.0	1.9	2.0	—	1.9	—	V	Vin = V <sub>IH</sub> or V <sub>IL</sub> I <sub>OH</sub> = -20 μA	
		4.5	4.4	4.5	—	4.4	—			
		6.0	5.9	6.0	—	5.9	—			
		4.5	4.18	—	—	4.13	—			I <sub>OH</sub> = -4 mA
		6.0	5.68	—	—	5.63	—			I <sub>OH</sub> = -5.2 mA
		6.0	—	0.0	0.1	—	0.1			V
	4.5	—	0.0	0.1	—	0.1				
	6.0	—	0.0	0.1	—	0.1				
	4.5	—	—	0.26	—	0.33	I <sub>OL</sub> = 4 mA			
	6.0	—	—	0.26	—	0.33	I <sub>OL</sub> = 5.2 mA			
Input current	I <sub>in</sub>	6.0	—	—	±0.1	—	±1.0	μA	Vin = V <sub>CC</sub> or GND	
Quiescent supply current	I <sub>CC</sub>	6.0	—	—	2.0	—	20	μA	Vin = V <sub>CC</sub> or GND, I <sub>out</sub> = 0 μA	

# HD74HC108

## AC Characteristics ( $C_L = 50$ pF, Input $t_r = t_f = 6$ ns)

Item	Symbol	$V_{CC}$ (V)	$T_a = 25^\circ\text{C}$			$T_a = -40$ to $+85^\circ\text{C}$		Unit	Test Conditions	
			Min	Typ	Max	Min	Max			
Maximum clock frequency	$f_{max}$	2.0	—	—	6	—	5	MHz		
		4.5	—	—	30	—	24			
		6.0	—	—	35	—	28			
Propagation delay time	$t_{PLH}$	2.0	—	—	150	—	190	ns	Clock to Q or $\bar{Q}$	
		4.5	—	20	30	—	38			
		6.0	—	—	26	—	33			
	$t_{PHL}$	2.0	—	—	140	—	175	ns	Clear to Q or $\bar{Q}$	
		4.5	—	18	28	—	35			
		6.0	—	—	24	—	30			
Pulse width	$t_w$	2.0	80	—	—	100	—	ns		
		4.5	16	7	—	20	—			
		6.0	14	—	—	17	—			
	Setup time	$t_{su}$	2.0	100	—	—	125	—	ns	
			4.5	20	2	—	25	—		
			6.0	17	—	—	21	—		
Hold time	$t_h$	2.0	5	—	—	5	—	ns		
		4.5	5	-1	—	5	—			
		6.0	5	—	—	5	—			
Removal time	$t_{rem}$	2.0	100	—	—	125	—	ns		
		4.5	20	-2	—	25	—			
		6.0	17	—	—	21	—			
Output rise/fall time	$t_{TLH}$	2.0	—	—	75	—	95	ns		
		4.5	—	5	15	—	19			
	$t_{THL}$	6.0	—	—	13	—	16			
Input capacitance	$C_{in}$	—	—	5	10	—	10	pF		



Hitachi Code	DP-14
JEDEC	Conforms
EIAJ	Conforms
Weight (reference value)	0.97 g

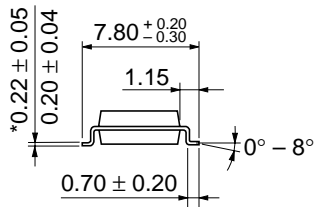

Hitachi Code	FP-14DA
JEDEC	—
EIAJ	Conforms
Weight (reference value)	0.23 g

\*Dimension including the plating thickness  
Base material dimension



Hitachi Code	FP-14DN
JEDEC	Conforms
EIAJ	Conforms
Weight (reference value)	0.13 g

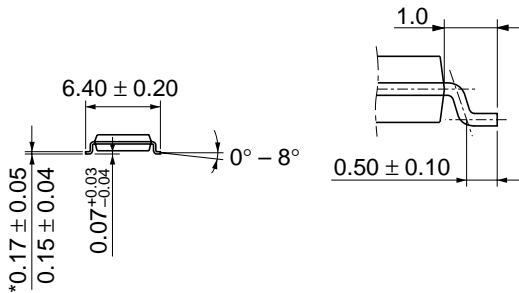
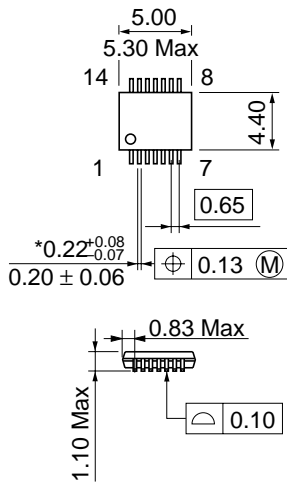

\*Dimension including the plating thickness  
 Base material dimension

Hitachi Code	TTP-14D
JEDEC	—
EIAJ	—
Weight (reference value)	0.05 g



## Cautions

1. Hitachi neither warrants nor grants licenses of any rights of Hitachi's or any third party's patent, copyright, trademark, or other intellectual property rights for information contained in this document. Hitachi bears no responsibility for problems that may arise with third party's rights, including intellectual property rights, in connection with use of the information contained in this document.
2. Products and product specifications may be subject to change without notice. Confirm that you have received the latest product standards or specifications before final design, purchase or use.
3. Hitachi makes every attempt to ensure that its products are of high quality and reliability. However, contact Hitachi's sales office before using the product in an application that demands especially high quality and reliability or where its failure or malfunction may directly threaten human life or cause risk of bodily injury, such as aerospace, aeronautics, nuclear power, combustion control, transportation, traffic, safety equipment or medical equipment for life support.
4. Design your application so that the product is used within the ranges guaranteed by Hitachi particularly for maximum rating, operating supply voltage range, heat radiation characteristics, installation conditions and other characteristics. Hitachi bears no responsibility for failure or damage when used beyond the guaranteed ranges. Even within the guaranteed ranges, consider normally foreseeable failure rates or failure modes in semiconductor devices and employ systemic measures such as fail-safes, so that the equipment incorporating Hitachi product does not cause bodily injury, fire or other consequential damage due to operation of the Hitachi product.
5. This product is not designed to be radiation resistant.
6. No one is permitted to reproduce or duplicate, in any form, the whole or part of this document without written approval from Hitachi.
7. Contact Hitachi's sales office for any questions regarding this document or Hitachi semiconductor products.

# HITACHI

## Hitachi, Ltd.

Semiconductor & Integrated Circuits.  
Nippon Bldg., 2-6-2, Ohte-machi, Chiyoda-ku, Tokyo 100-0004, Japan  
Tel: Tokyo (03) 3270-2111 Fax: (03) 3270-5109

URL      North America      : <http://semiconductor.hitachi.com/>  
             Europe                 : <http://www.hitachi-eu.com/hel/ecg>  
             Asia (Singapore)       : <http://www.has.hitachi.com.sg/grp3/sicd/index.htm>  
             Asia (Taiwan)             : [http://www.hitachi.com.tw/E/Product/SICD\\_Frame.htm](http://www.hitachi.com.tw/E/Product/SICD_Frame.htm)  
             Asia (HongKong)        : <http://www.hitachi.com.hk/eng/bo/grp3/index.htm>  
             Japan                        : <http://www.hitachi.co.jp/Sicd/indx.htm>

## For further information write to:

Hitachi Semiconductor  
(America) Inc.  
179 East Tasman Drive,  
San Jose, CA 95134  
Tel: <1> (408) 433-1990  
Fax: <1> (408) 433-0223

Hitachi Europe GmbH  
Electronic components Group  
Dornacher Straße 3  
D-85622 Feldkirchen, Munich  
Germany  
Tel: <49> (89) 9 9180-0  
Fax: <49> (89) 9 29 30 00

Hitachi Europe Ltd.  
Electronic Components Group.  
Whitebrook Park  
Lower Cookham Road  
Maidenhead  
Berkshire SL6 8YA, United Kingdom  
Tel: <44> (1628) 585000  
Fax: <44> (1628) 778322

Hitachi Asia Pte. Ltd.  
16 Collyer Quay #20-00  
Hitachi Tower  
Singapore 049318  
Tel: 535-2100  
Fax: 535-1533

Hitachi Asia Ltd.  
Taipei Branch Office  
3F, Hung Kuo Building, No.167,  
Tun-Hwa North Road, Taipei (105)  
Tel: <886> (2) 2718-3666  
Fax: <886> (2) 2718-8180

Hitachi Asia (Hong Kong) Ltd.  
Group III (Electronic Components)  
7/F., North Tower, World Finance Centre,  
Harbour City, Canton Road, Tsim Sha Tsui,  
Kowloon, Hong Kong  
Tel: <852> (2) 735 9218  
Fax: <852> (2) 730 0281  
Telex: 40815 HITEC HX

Copyright ' Hitachi, Ltd., 1999. All rights reserved. Printed in Japan.

**HITACHI**