

HD74HC123A

Dual Retriggerable Monostable Multivibrators (with Clear)

REJ03D0564-0200
 (Previous ADE-205-438)
 Rev.2.00
 Oct 11, 2005

Description

This multivibrator features both a negative, A, and a positive, B, transition triggered input, either of which can be used as an inhibit input. Also included is a clear input that when taken low resets the one shot. The HD74HC123A can be triggered on the positive transition of the clear while A is held low and B is held high.

The HD74HC123A is retriggerable. That is it may be triggered repeatedly while their outputs are generating a pulse and the pulse will be extended.

Pulse width stability over a wide range of temperature. The output pulse equation is simply: $t_w = (R_{ext}) (C_{ext})$.









Features

- High Speed Operation
- High Output Current: Fanout of 10 LSTTL Loads
- Wide Operating Voltage: $V_{CC} = 2$ to 6 V
- Low Input Current: 1 μ A max
- Low Quiescent Supply Current
- Ordering Information

Part Name	Package Type	Package Code (Previous Code)	Package Abbreviation	Taping Abbreviation (Quantity)
HD74HC123AP	DILP-16 pin	PRDP0016AE-B (DP-16FV)	P	—
HD74HC123AFPEL	SOP-16 pin (JEITA)	PRSP0016DH-B (FP-16DAV)	FP	EL (2,000 pcs/reel)

Note: Please consult the sales office for the above package availability.

Function Table

Clear	Inputs		Outputs	
	A	B	Q	\bar{Q}
L	X	X	L	H
X	H	X	L	H
X	X	L	L	H
H	L			
H		H		
	L	H		

Note: External timing capacitance connects between C_{ext} and R_{ext}/C_{ext} .

H: High level
 L: Low level
 X: Irrelevant

Pin Arrangement

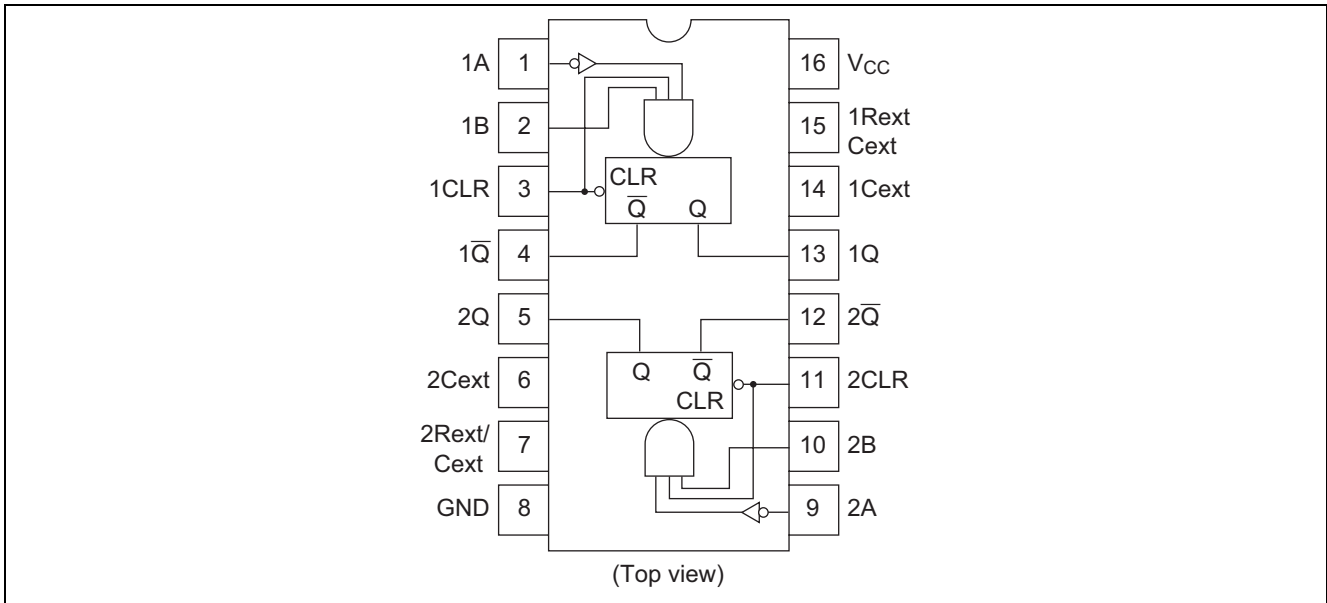

Absolute Maximum Ratings

Item	Symbol	Ratings	Unit
Supply voltage range	V_{CC}	-0.5 to 7.0	V
Input / Output voltage	V_{in}, V_{out}	-0.5 to $V_{CC} + 0.5$	V
Input / Output diode current	I_{IK}, I_{OK}	± 20	mA
Output current	I_o	± 25	mA
V_{CC}, GND current	I_{CC} or I_{GND}	± 50	mA
Power dissipation	P_T	500	mW
Storage temperature	T_{stg}	-65 to +150	$^{\circ}C$

Note: The absolute maximum ratings are values, which must not individually be exceeded, and furthermore, no two of which may be realized at the same time.

Recommended Operating Conditions

Item	Symbol	Ratings	Unit	Conditions
Supply voltage	V_{CC}	2 to 6	V	
Input / Output voltage	V_{IN}, V_{OUT}	0 to V_{CC}	V	
Operating temperature	T_a	-40 to 85	$^{\circ}C$	
Input rise / fall time ^{*1}	t_r, t_f	0 to 1000	ns	$V_{CC} = 2.0 V$
		0 to 500		$V_{CC} = 4.5 V$
		0 to 400		$V_{CC} = 6.0 V$

Note: 1. This item guarantees maximum limit when one input switches.
Waveform: Refer to test circuit of switching characteristics.

Electrical Characteristics

Item	Symbol	V _{CC} (V)	Ta = 25°C			Ta = -40 to+85°C		Unit	Test Conditions		
			Min	Typ	Max	Min	Max				
Input voltage	V _{IH}	2.0	1.5	—	—	1.5	—	V			
		4.5	3.15	—	—	3.15	—				
		6.0	4.2	—	—	4.2	—				
	V _{IL}	2.0	—	—	0.5	—	0.5	V			
		4.5	—	—	1.35	—	1.35				
		6.0	—	—	1.8	—	1.8				
Output voltage	V _{OH}	2.0	1.9	2.0	—	1.9	—	V	V _{in} = V _{IH} or V _{IL}	I _{OH} = -20 μA	
		4.5	4.4	4.5	—	4.4	—			I _{OH} = -4 mA	
		6.0	5.9	6.0	—	5.9	—			I _{OH} = -5.2 mA	
		4.5	4.18	—	—	4.13	—				
		6.0	5.68	—	—	5.63	—				
	V _{OL}	2.0	—	0.0	0.1	—	0.1	V	V _{in} = V _{IH} or V _{IL}	I _{OL} = 20 μA	
		4.5	—	0.0	0.1	—	0.1				
		6.0	—	0.0	0.1	—	0.1				
		4.5	—	—	0.26	—	0.33			I _{OL} = 4 mA	
		6.0	—	—	0.26	—	0.33			I _{OL} = 5.2 mA	
Input current	I _{in}	6.0	—	—	±0.1	—	±1.0	μA	V _{in} = V _{CC} or GND		
Quiescent supply current	Standby state	I _{CC}	6.0	—	—	130	—	220	μA	V _{in} = V _{CC} or GND	I _{out} = 0 μA
	Active state		6.0	—	—	130	—	220			R _{ext} /C _{ext} = 0.5 V _{CC}

Switching Characteristics ($C_L = 50\text{ pF}$, Input $t_r = t_f = 6\text{ ns}$)

Item	Symbol	V_{CC} (V)	$T_a = 25^\circ\text{C}$			$T_a = -40\text{ to }+85^\circ\text{C}$		Unit	Test Conditions	
			Min	Typ	Max	Min	Max			
Propagation delay time	t_{PLH}	2.0	—	—	210	—	265	ns	A, B or Clear to Q	
		4.5	—	22	42	—	53			
		6.0	—	—	36	—	45			
	t_{PHL}	2.0	—	—	240	—	300	ns	A, B or Clear to \bar{Q}	
		4.5	—	23	48	—	60			
		6.0	—	—	41	—	51			
	t_{PHL}	2.0	—	—	170	—	215	ns	Clear to Q	
		4.5	—	18	34	—	43			
		6.0	—	—	29	—	37			
	t_{PLH}	2.0	—	—	180	—	225	ns	Clear to \bar{Q}	
		4.5	—	16	36	—	45			
		6.0	—	—	31	—	38			
Output rise/fall time	t_{TLH}, t_{THL}	2.0	—	—	75	—	95	ns		
		4.5	—	5	15	—	19			
		6.0	—	—	13	—	16			
Pulse width	t_w	2.0	150	—	—	190	—	ns	A, B, Clear	
		4.5	30	6	—	38	—			
		6.0	26	—	—	33	—			
Minimum output pulse width	$t_{wQ(\text{min})}$	2.0	—	1.5	—	—	—	μs	Cext = 28 pF	Rest = 6 k Ω
		4.5	—	450	—	—	—			ns
		6.0	—	380	—	—	—			
Output pulse width	t_{wQ}	4.5	—	1.0	—	—	—	ms	Cext = 0.1 μF , Rest = 10 k Ω	
Input capacitance	Cin	—	—	5	10	—	10	pF		

Caution in use: In order to prevent any malfunctions due to noise, connect a high-frequency performance capacitor between V_{CC} and GND, and keep the wiring between the External components and Cext, Rest/Cext pins as short as possible.

Test Circuit

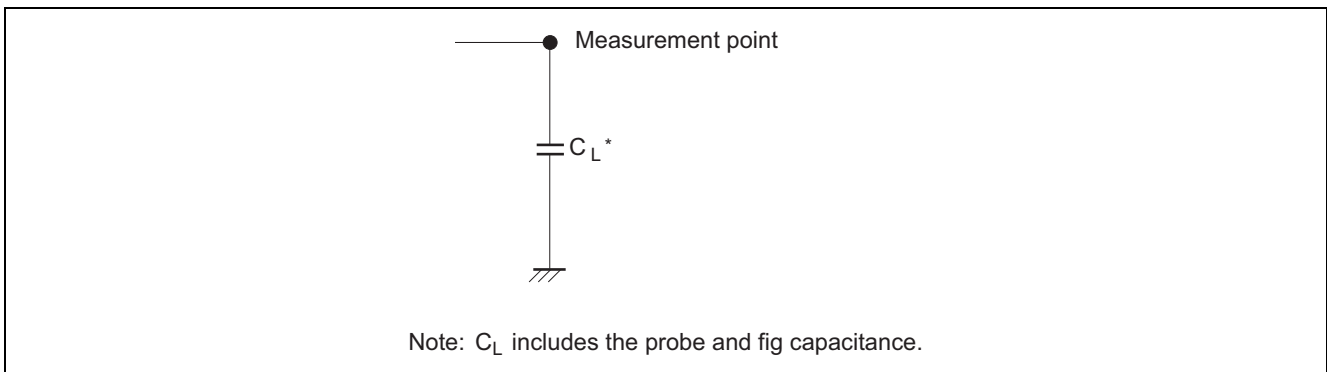

Application Data

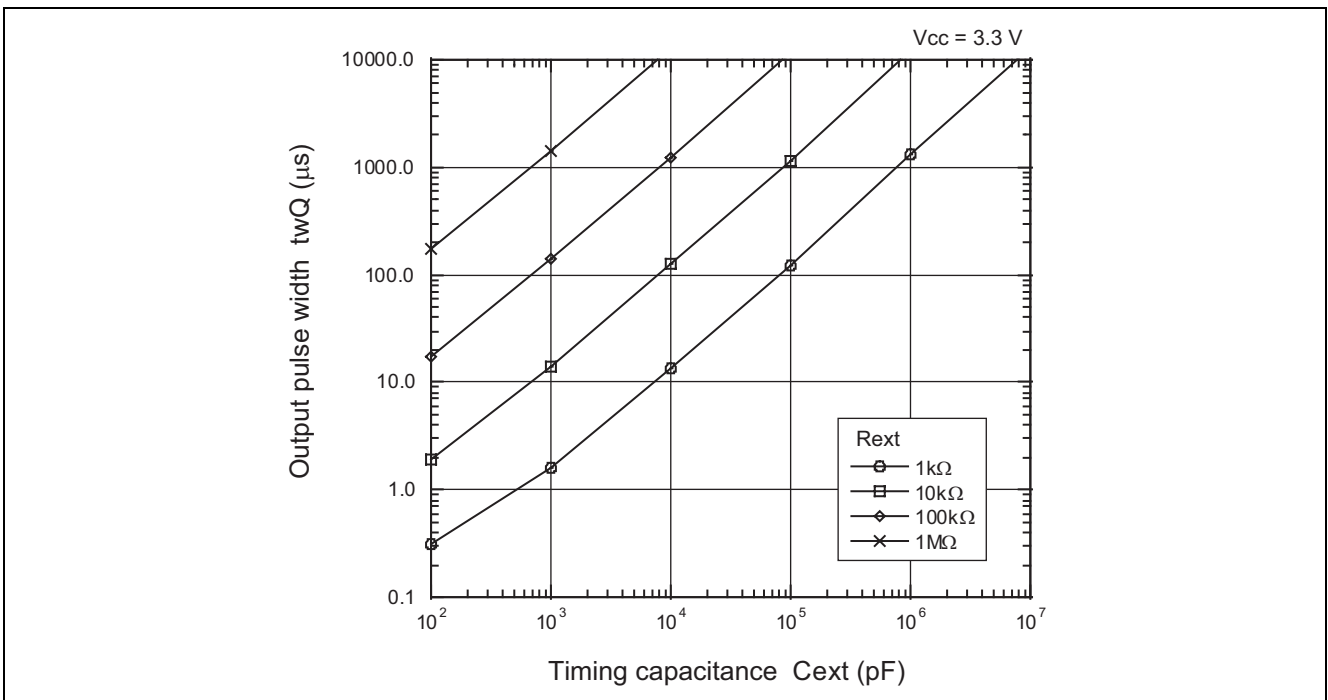
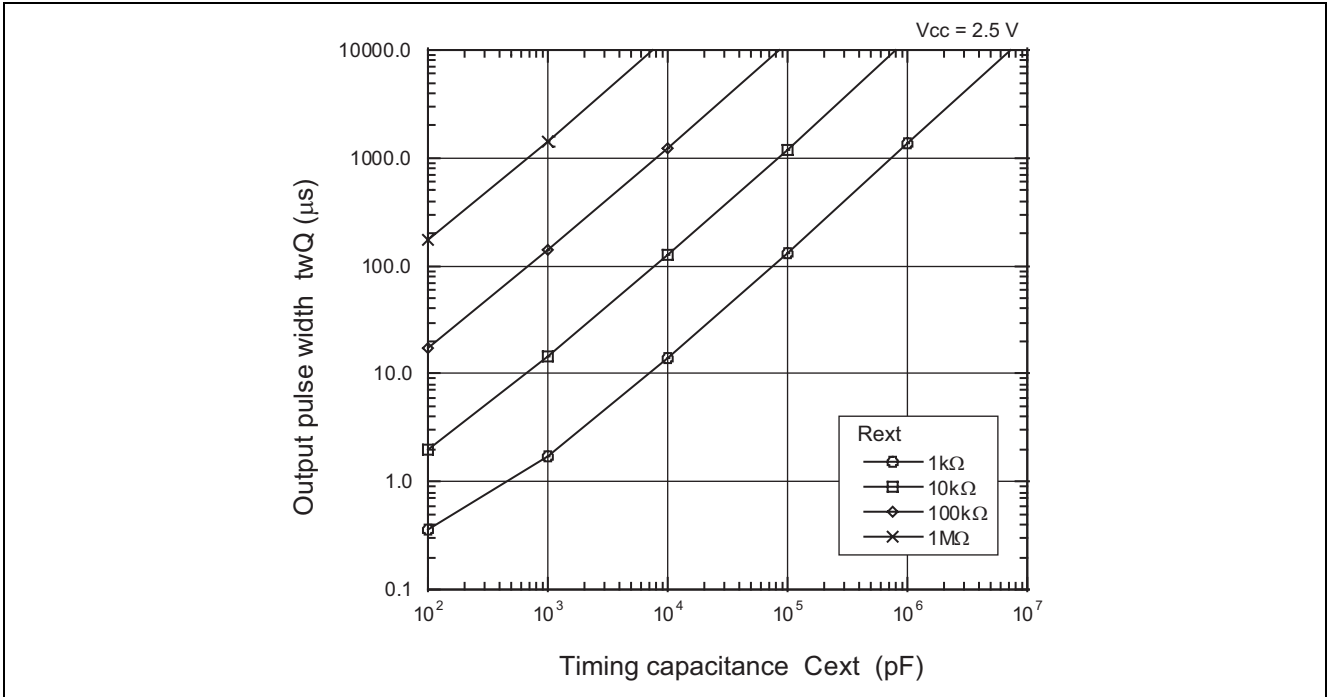

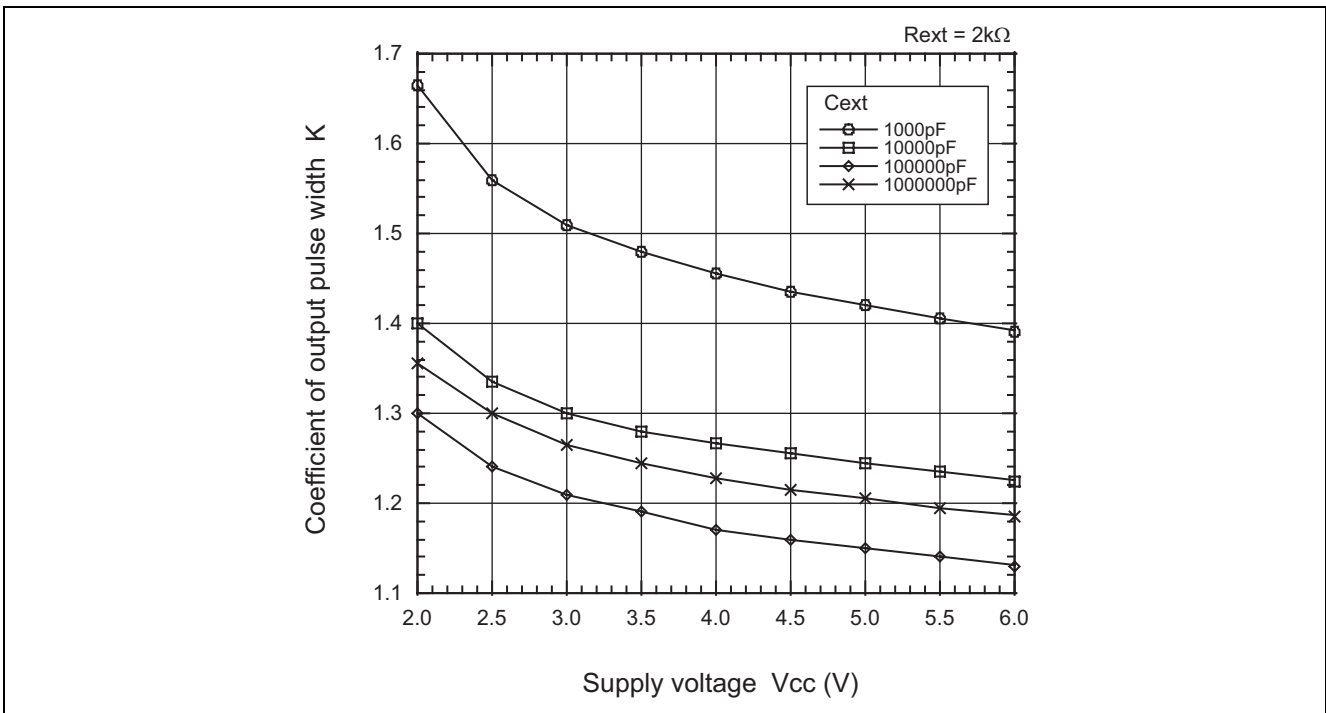
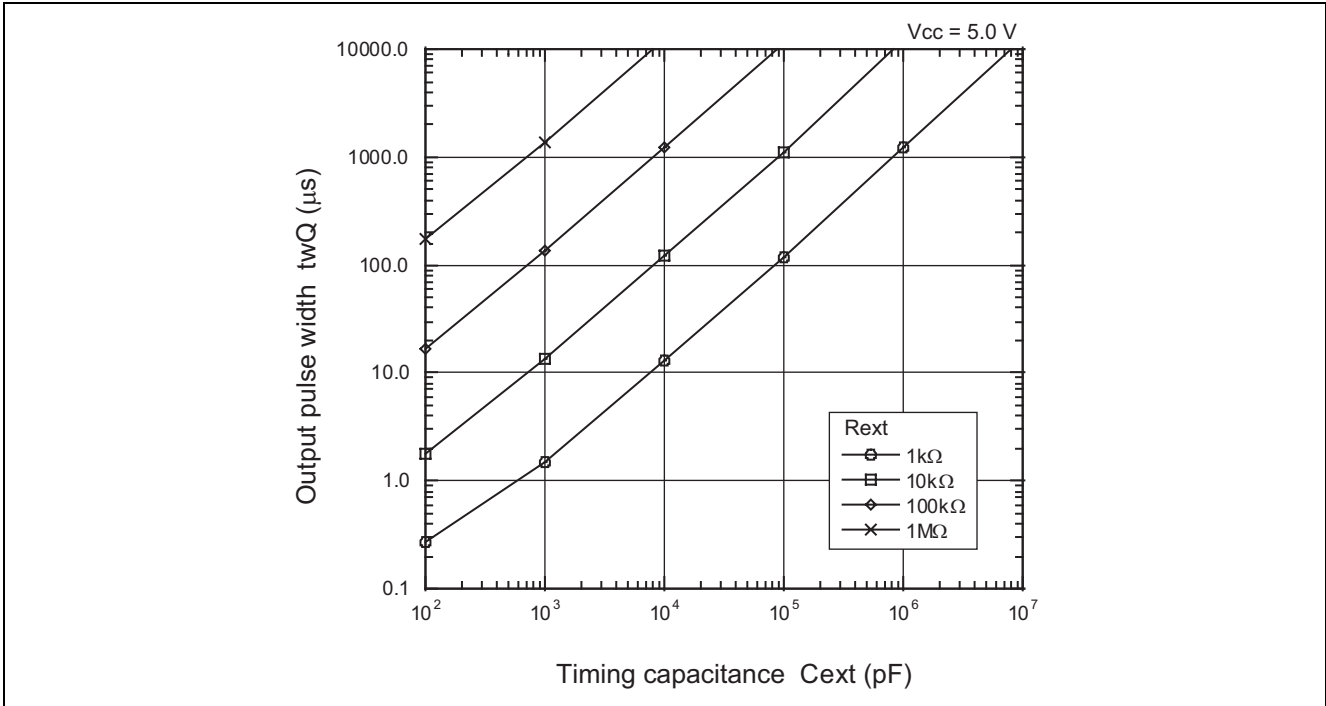

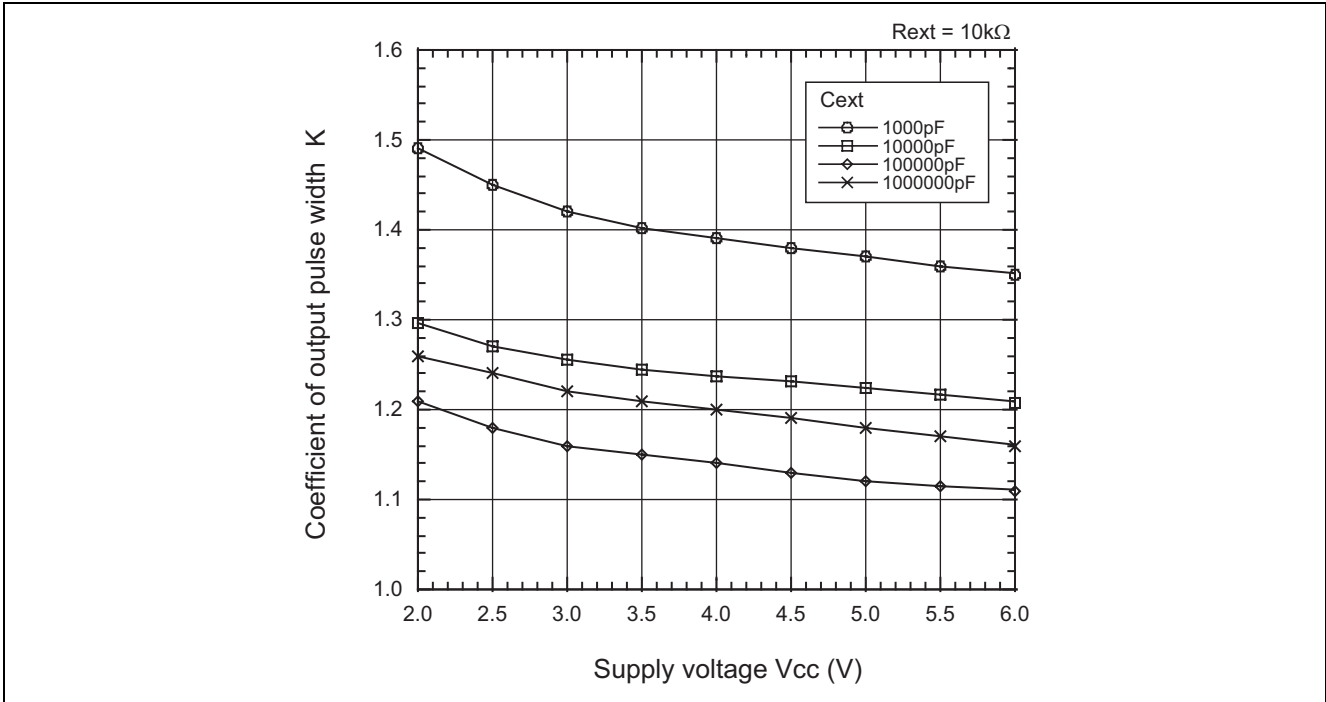

Package Dimensions

JEITA Package Code	RENESAS Code	Previous Code	MASS[Typ.]
P-DIP16-6.3x19.2-2.54	PRDP0016AE-B	DP-16FV	1.05g

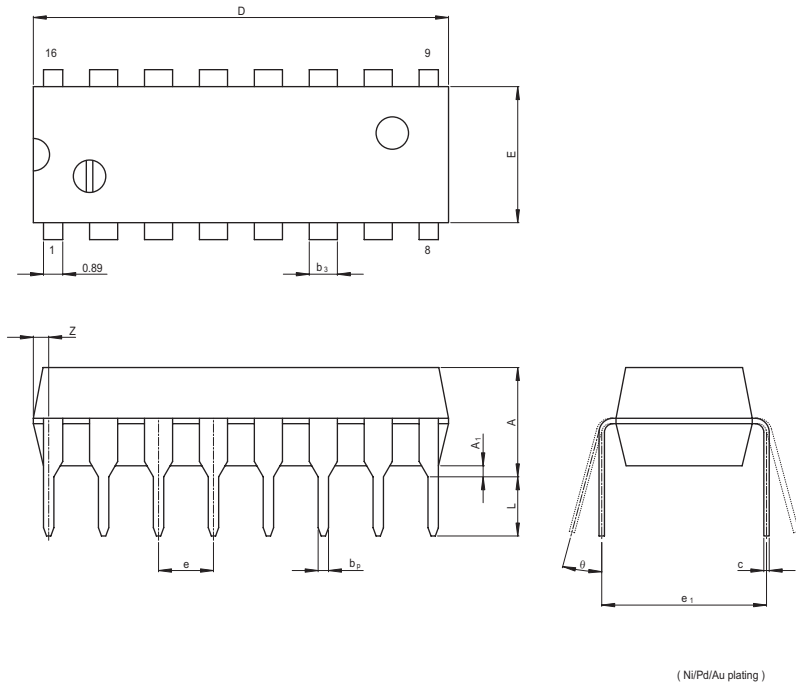

Reference Symbol	Dimension in Millimeters		
	Min	Nom	Max
e ₁	—	7.62	—
D	—	19.2	20.32
E	—	6.3	7.4
A	—	—	5.06
A ₁	0.51	—	—
b _p	0.40	0.48	0.56
b ₃	—	1.30	—
c	0.19	0.25	0.31
θ	0°	—	15°
e	2.29	2.54	2.79
Z	—	—	1.12
L	2.54	—	—

(Ni/Pd/Au plating)

JEITA Package Code	RENESAS Code	Previous Code	MASS[Typ.]
P-SOP16-5.5x10.06-1.27	PRSP0016DH-B	FP-16DAV	0.24g

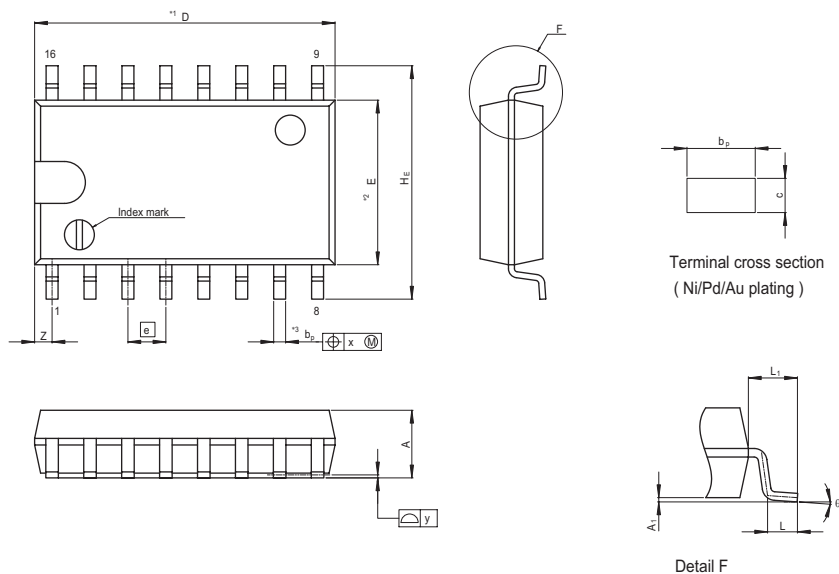

NOTE)
 1. DIMENSIONS**1 (Nom)"AND"*2"
 DO NOT INCLUDE MOLD FLASH.
 2. DIMENSION"*3"DOES NOT
 INCLUDE TRIM OFFSET.

Reference Symbol	Dimension in Millimeters		
	Min	Nom	Max
D	—	10.06	10.5
E	—	5.50	—
A ₂	—	—	—
A ₁	0.00	0.10	0.20
A	—	—	2.20
b _p	0.34	0.40	0.46
b ₁	—	—	—
c	0.15	0.20	0.25
c ₁	—	—	—
θ	0°	—	8°
HE	7.50	7.80	8.00
Ⓜ	—	1.27	—
x	—	—	0.12
y	—	—	0.15
Z	—	—	0.80
L	0.50	0.70	0.90
L ₁	—	1.15	—

Detail F

Keep safety first in your circuit designs!

1. Renesas Technology Corp. puts the maximum effort into making semiconductor products better and more reliable, but there is always the possibility that trouble may occur with them. Trouble with semiconductors may lead to personal injury, fire or property damage. Remember to give due consideration to safety when making your circuit designs, with appropriate measures such as (i) placement of substitutive, auxiliary circuits, (ii) use of nonflammable material or (iii) prevention against any malfunction or mishap.

Notes regarding these materials

1. These materials are intended as a reference to assist our customers in the selection of the Renesas Technology Corp. product best suited to the customer's application; they do not convey any license under any intellectual property rights, or any other rights, belonging to Renesas Technology Corp. or a third party.
2. Renesas Technology Corp. assumes no responsibility for any damage, or infringement of any third-party's rights, originating in the use of any product data, diagrams, charts, programs, algorithms, or circuit application examples contained in these materials.
3. All information contained in these materials, including product data, diagrams, charts, programs and algorithms represents information on products at the time of publication of these materials, and are subject to change by Renesas Technology Corp. without notice due to product improvements or other reasons. It is therefore recommended that customers contact Renesas Technology Corp. or an authorized Renesas Technology Corp. product distributor for the latest product information before purchasing a product listed herein.
The information described here may contain technical inaccuracies or typographical errors.
Renesas Technology Corp. assumes no responsibility for any damage, liability, or other loss rising from these inaccuracies or errors.
Please also pay attention to information published by Renesas Technology Corp. by various means, including the Renesas Technology Corp. Semiconductor home page (<http://www.renesas.com>).
4. When using any or all of the information contained in these materials, including product data, diagrams, charts, programs, and algorithms, please be sure to evaluate all information as a total system before making a final decision on the applicability of the information and products. Renesas Technology Corp. assumes no responsibility for any damage, liability or other loss resulting from the information contained herein.
5. Renesas Technology Corp. semiconductors are not designed or manufactured for use in a device or system that is used under circumstances in which human life is potentially at stake. Please contact Renesas Technology Corp. or an authorized Renesas Technology Corp. product distributor when considering the use of a product contained herein for any specific purposes, such as apparatus or systems for transportation, vehicular, medical, aerospace, nuclear, or undersea repeater use.
6. The prior written approval of Renesas Technology Corp. is necessary to reprint or reproduce in whole or in part these materials.
7. If these products or technologies are subject to the Japanese export control restrictions, they must be exported under a license from the Japanese government and cannot be imported into a country other than the approved destination.
Any diversion or reexport contrary to the export control laws and regulations of Japan and/or the country of destination is prohibited.
8. Please contact Renesas Technology Corp. for further details on these materials or the products contained therein.



RENESAS SALES OFFICES

<http://www.renesas.com>

Refer to "<http://www.renesas.com/en/network>" for the latest and detailed information.

Renesas Technology America, Inc.

450 Holger Way, San Jose, CA 95134-1368, U.S.A
Tel: <1> (408) 382-7500, Fax: <1> (408) 382-7501

Renesas Technology Europe Limited

Dukes Meadow, Millboard Road, Bourne End, Buckinghamshire, SL8 5FH, U.K.
Tel: <44> (1628) 585-100, Fax: <44> (1628) 585-900

Renesas Technology (Shanghai) Co., Ltd.

Unit 205, AZIA Center, No.133 Yincheng Rd (n), Pudong District, Shanghai 200120, China
Tel: <86> (21) 5877-1818, Fax: <86> (21) 6887-7898

Renesas Technology Hong Kong Ltd.

7th Floor, North Tower, World Finance Centre, Harbour City, 1 Canton Road, Tsimshatsui, Kowloon, Hong Kong
Tel: <852> 2265-6688, Fax: <852> 2730-6071

Renesas Technology Taiwan Co., Ltd.

10th Floor, No.99, Fushing North Road, Taipei, Taiwan
Tel: <886> (2) 2715-2888, Fax: <886> (2) 2713-2999

Renesas Technology Singapore Pte. Ltd.

1 Harbour Front Avenue, #06-10, Keppel Bay Tower, Singapore 098632
Tel: <65> 6213-0200, Fax: <65> 6278-8001

Renesas Technology Korea Co., Ltd.

Kukje Center Bldg. 18th Fl., 191, 2-ka, Hangang-ro, Yongsan-ku, Seoul 140-702, Korea
Tel: <82> (2) 796-3115, Fax: <82> (2) 796-2145

Renesas Technology Malaysia Sdn. Bhd

Unit 906, Block B, Menara Amcorp, Amcorp Trade Centre, No.18, Jalan Persiaran Barat, 46050 Petaling Jaya, Selangor Darul Ehsan, Malaysia
Tel: <603> 7955-9390, Fax: <603> 7955-9510