

HD74LV574A

Octal D-type Flip-Flops with 3-state Outputs

REJ03D0520-0100

Rev.1.00

Feb. 01, 2005

Description

The HD74LV574A has eight edge trigger D type flip flops with three state outputs in a 20 pin package. Data at the D inputs meeting set up requirements, are transferred to the Q outputs on positive going transitions of the clock input. When the clock input goes low, data at the D inputs will be retained at the outputs until clock input returns high again. When a high logic level is applied to the output control input, all outputs go to a high impedance state, regardless of what signals are present at the other inputs and the state of the storage elements. Low-voltage and high-speed operation is suitable for the battery-powered products (e.g., notebook computers), and the low-power consumption extends the battery life.

Features

- $V_{CC} = 2.0\text{ V to }5.5\text{ V}$ operation
- All inputs $V_{IH}(\text{Max.}) = 5.5\text{ V}$ ($@V_{CC} = 0\text{ V to }5.5\text{ V}$)
- All outputs $V_O(\text{Max.}) = 5.5\text{ V}$ ($@V_{CC} = 0\text{ V}$)
- Typical V_{OL} ground bounce $< 0.8\text{ V}$ ($@V_{CC} = 3.3\text{ V}$, $T_a = 25^\circ\text{C}$)
- Typical V_{OH} undershoot $> 2.3\text{ V}$ ($@V_{CC} = 3.3\text{ V}$, $T_a = 25^\circ\text{C}$)
- Output current $\pm 8\text{ mA}$ ($@V_{CC} = 3.0\text{ V to }3.6\text{ V}$), $\pm 16\text{ mA}$ ($@V_{CC} = 4.5\text{ V to }5.5\text{ V}$)
- Ordering Information

| Part Name | Package Type | Package Code (Previous Code) | Package Abbreviation | Taping Abbreviation (Quantity) |
|----------------|--------------------|---------------------------------|-------------------------|-----------------------------------|
| HD74LV574AFPEL | SOP-20 pin (JEITA) | PRSP0020DD-B (FP-20DAV) | FP | EL (2,000 pcs/reel) |
| HD74LV574ATELL | TSSOP-20 pin | PTSP0020JB-A (TTP-20DAV) | T | ELL (2,000 pcs/reel) |

Function Table

| \overline{OE} | Inputs | | Output Q |
|-----------------|--------------|---|----------|
| | CLK | D | |
| H | X | X | Z |
| L | \uparrow | L | L |
| L | \uparrow | H | H |
| L | \downarrow | X | Q_0 |

Note: H: High level

L: Low level

X: Immaterial

Z: High impedance

Q_0 : Output level before the indicated steady state input conditions were established.

Pin Arrangement

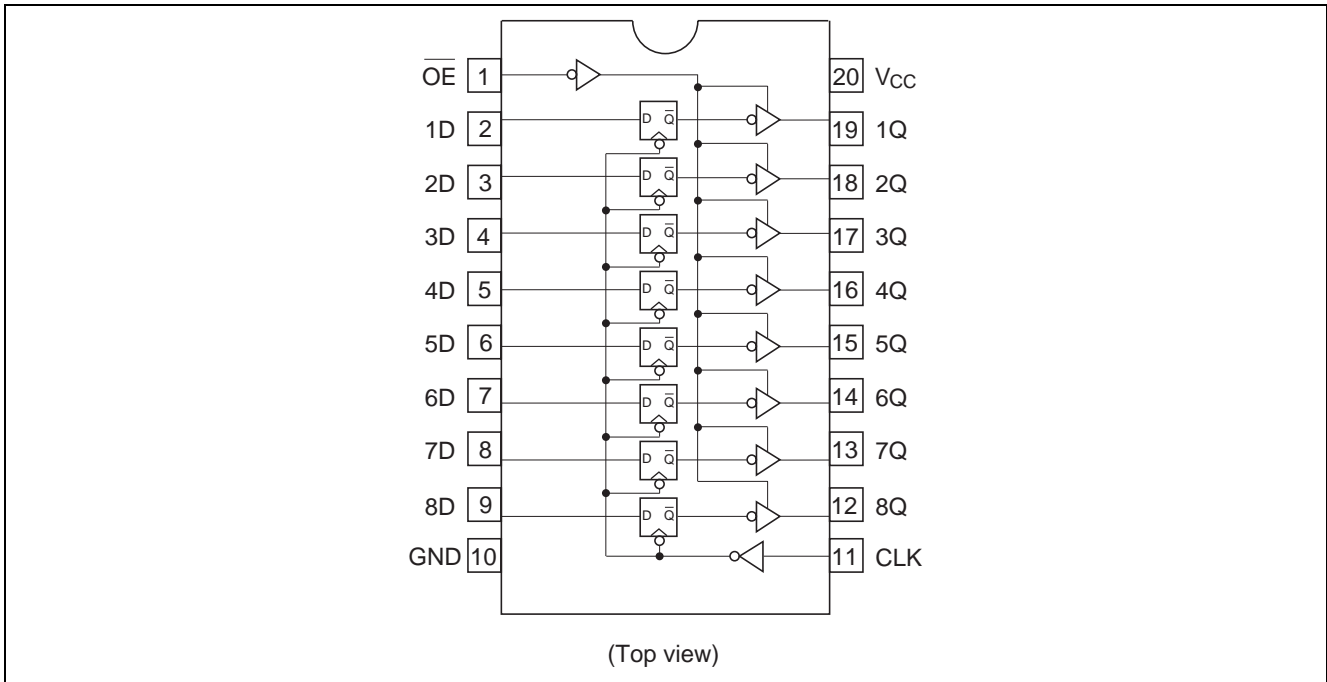

Absolute Maximum Ratings

| Item | Symbol | Ratings | Unit | Conditions |
|------------------------------------------------------------------------------------|-----------------------|------------------------|------------------|-----------------------------|
| Supply voltage range | V_{CC} | -0.5 to 7.0 | V | |
| Input voltage range ^{*1} | V_I | -0.5 to 7.0 | V | |
| Output voltage range ^{*1, 2} | V_O | -0.5 to $V_{CC} + 0.5$ | V | Output: H or L |
| | | -0.5 to 7.0 | | V_{CC} : OFF or Output: Z |
| Input clamp current | I_{IK} | -20 | mA | $V_I < 0$ |
| Output clamp current | I_{OK} | ± 50 | mA | $V_O < 0$ or $V_O > V_{CC}$ |
| Continuous output current | I_O | ± 35 | mA | $V_O = 0$ to V_{CC} |
| Continuous current through V_{CC} or GND | I_{CC} or I_{GND} | ± 70 | mA | |
| | | | | |
| Maximum power dissipation at $T_a = 25^\circ\text{C}$ (in still air) ^{*3} | P_T | 835 | mW | SOP |
| | | 757 | | TSSOP |
| Storage temperature | T_{stg} | -65 to 150 | $^\circ\text{C}$ | |

Notes: The absolute maximum ratings are values, which must not individually be exceeded, and furthermore, no two of which may be realized at the same time.

1. The input and output voltage ratings may be exceeded if the input and output clamp-current ratings are observed.
2. This value is limited to 5.5 V maximum.
3. The maximum package power dissipation was calculated using a junction temperature of 150 $^\circ\text{C}$.

Recommended Operating Conditions

| Item | Symbol | Min | Max | Unit | Conditions |
|------------------------------------|-----------------------|-----|----------|-------------|----------------------------------|
| Supply voltage range | V_{CC} | 2.0 | 5.5 | V | |
| Input voltage range | V_I | 0 | 5.5 | V | |
| Output voltage range | V_O | 0 | V_{CC} | V | H or L |
| | | 0 | 5.5 | | High impedance state |
| Output current | I_{OH} | — | −50 | μA | $V_{CC} = 2.0 V$ |
| | | — | −2 | mA | $V_{CC} = 2.3 \text{ to } 2.7 V$ |
| | | — | −8 | | $V_{CC} = 3.0 \text{ to } 3.6 V$ |
| | | — | −16 | | $V_{CC} = 4.5 \text{ to } 5.5 V$ |
| | I_{OL} | — | 50 | μA | $V_{CC} = 2.0 V$ |
| | | — | 2 | mA | $V_{CC} = 2.3 \text{ to } 2.7 V$ |
| | | — | 8 | | $V_{CC} = 3.0 \text{ to } 3.6 V$ |
| | | — | 16 | | $V_{CC} = 4.5 \text{ to } 5.5 V$ |
| Input transition rise or fall rate | $\Delta t / \Delta v$ | 0 | 200 | ns/V | $V_{CC} = 2.3 \text{ to } 2.7 V$ |
| | | 0 | 100 | | $V_{CC} = 3.0 \text{ to } 3.6 V$ |
| | | 0 | 20 | | $V_{CC} = 4.5 \text{ to } 5.5 V$ |
| Operating free-air temperature | T_a | −40 | 85 | $^{\circ}C$ | |

Note: Unused or floating inputs must be held high or low.

DC Electrical Characteristics

$T_a = -40 \text{ to } 85^{\circ}C$

| Item | Symbol | $V_{CC} (V)^*$ | Min | Typ | Max | Unit | Test Conditions |
|--------------------------|-----------|----------------|---------------------|-----|---------------------|---------|---------------------------------------------|
| Input voltage | V_{IH} | 2.0 | 1.5 | — | — | V | |
| | | 2.3 to 2.7 | $V_{CC} \times 0.7$ | — | — | | |
| | | 3.0 to 3.6 | $V_{CC} \times 0.7$ | — | — | | |
| | | 4.5 to 5.5 | $V_{CC} \times 0.7$ | — | — | | |
| | V_{IL} | 2.0 | — | — | 0.5 | | |
| | | 2.3 to 2.7 | — | — | $V_{CC} \times 0.3$ | | |
| | | 3.0 to 3.6 | — | — | $V_{CC} \times 0.3$ | | |
| | | 4.5 to 5.5 | — | — | $V_{CC} \times 0.3$ | | |
| Output voltage | V_{OH} | Min to Max | $V_{CC} - 0.1$ | — | — | V | $I_{OH} = -50 \mu A$ |
| | | 2.3 | 2.0 | — | — | | $I_{OH} = -2 \text{ mA}$ |
| | | 3.0 | 2.48 | — | — | | $I_{OH} = -8 \text{ mA}$ |
| | | 4.5 | 3.8 | — | — | | $I_{OH} = -16 \text{ mA}$ |
| | V_{OL} | Min to Max | — | — | 0.1 | | $I_{OL} = 50 \mu A$ |
| | | 2.3 | — | — | 0.4 | | $I_{OL} = 2 \text{ mA}$ |
| | | 3.0 | — | — | 0.44 | | $I_{OL} = 8 \text{ mA}$ |
| | | 4.5 | — | — | 0.55 | | $I_{OL} = 16 \text{ mA}$ |
| Input current | I_{IN} | 0 to 5.5 | — | — | ± 1 | μA | $V_{IN} = 5.5 V \text{ or } GND$ |
| Off-state output current | I_{OZ} | 5.5 | — | — | ± 5 | μA | $V_O = V_{CC} \text{ or } GND$ |
| Quiescent supply current | I_{CC} | 5.5 | — | — | 20 | μA | $V_{IN} = V_{CC} \text{ or } GND, I_O = 0$ |
| Output leakage current | I_{OFF} | 0 | — | — | 5 | μA | $V_I \text{ or } V_O = 0 \text{ to } 5.5 V$ |
| Input capacitance | C_{IN} | 3.3 | — | 2.9 | — | pF | $V_I = V_{CC} \text{ or } GND$ |

Note: For conditions shown as Min or Max, use the appropriate values under recommended operating conditions.

Switching Characteristics

V_{CC} = 2.5 ± 0.2 V

| Item | Symbol | Ta = 25°C | | | Ta = -40 to 85°C | | Unit | Test Conditions | FROM (Input) | TO (Output) |
|-------------------------|------------------|-----------|------|------|------------------|------|------|------------------------|-------------------|-------------|
| | | Min | Typ | Max | Min | Max | | | | |
| Maximum clock frequency | t _{max} | 60 | 105 | — | 50 | — | MHz | C _L = 15 pF | | |
| | | 50 | 85 | — | 40 | — | | C _L = 50 pF | | |
| Propagation delay time | t _{PLH} | — | 9.7 | 16.6 | 1.0 | 20.0 | ns | C _L = 15 pF | CLK | Q |
| | t _{PHL} | — | 11.8 | 19.6 | 1.0 | 23.0 | | C _L = 50 pF | | |
| Enable time | t _{ZH} | — | 8.9 | 16.1 | 1.0 | 19.0 | ns | C _L = 15 pF | OE | Q |
| | t _{ZL} | — | 10.9 | 19.0 | 1.0 | 22.0 | | C _L = 50 pF | | |
| Disable time | t _{HZ} | — | 6.3 | 12.8 | 1.0 | 15.0 | ns | C _L = 15 pF | OE | Q |
| | t _{LZ} | — | 8.2 | 17.5 | 1.0 | 20.0 | | C _L = 50 pF | | |
| Setup time | t _{SU} | 5.5 | — | — | 5.5 | — | ns | | Data before CLK ↑ | |
| Hold time | t _H | 2.0 | — | — | 2.0 | — | ns | | Data after CLK ↑ | |
| Pulse width | t _w | 7.0 | — | — | 7.0 | — | ns | | CLK: "H" or "L" | |

V_{CC} = 3.3 ± 0.3 V

| Item | Symbol | Ta = 25°C | | | Ta = -40 to 85°C | | Unit | Test Conditions | FROM (Input) | TO (Output) |
|-------------------------|------------------|-----------|-----|------|------------------|------|------|------------------------|-------------------|-------------|
| | | Min | Typ | Max | Min | Max | | | | |
| Maximum clock frequency | t _{max} | 80 | 150 | — | 70 | — | MHz | C _L = 15 pF | | |
| | | 55 | 110 | — | 50 | — | | C _L = 50 pF | | |
| Propagation delay time | t _{PLH} | — | 6.8 | 13.2 | 1.0 | 15.5 | ns | C _L = 15 pF | CLK | Q |
| | t _{PHL} | — | 8.3 | 16.7 | 1.0 | 19.0 | | C _L = 50 pF | | |
| Enable time | t _{ZH} | — | 6.3 | 12.8 | 1.0 | 15.0 | ns | C _L = 15 pF | OE | Q |
| | t _{ZL} | — | 7.7 | 16.3 | 1.0 | 18.5 | | C _L = 50 pF | | |
| Disable time | t _{HZ} | — | 4.7 | 13.0 | 1.0 | 15.0 | ns | C _L = 15 pF | OE | Q |
| | t _{LZ} | — | 5.9 | 15.0 | 1.0 | 17.0 | | C _L = 50 pF | | |
| Setup time | t _{SU} | 3.5 | — | — | 3.5 | — | ns | | Data before CLK ↑ | |
| Hold time | t _H | 1.5 | — | — | 1.5 | — | ns | | Data after CLK ↑ | |
| Pulse width | t _w | 5.0 | — | — | 5.0 | — | ns | | CLK: "H" or "L" | |

V_{CC} = 5.0 ± 0.5 V

| Item | Symbol | Ta = 25°C | | | Ta = -40 to 85°C | | Unit | Test Conditions | FROM (Input) | TO (Output) |
|-------------------------|------------------|-----------|-----|------|------------------|------|------|------------------------|-------------------|-------------|
| | | Min | Typ | Max | Min | Max | | | | |
| Maximum clock frequency | t _{max} | 130 | 205 | — | 110 | — | MHz | C _L = 15 pF | | |
| | | 85 | 170 | — | 75 | — | | C _L = 50 pF | | |
| Propagation delay time | t _{PLH} | — | 4.9 | 8.6 | 1.0 | 10.0 | ns | C _L = 15 pF | CLK | Q |
| | t _{PHL} | — | 5.9 | 10.6 | 1.0 | 12.0 | | C _L = 50 pF | | |
| Enable time | t _{ZH} | — | 4.6 | 9.0 | 1.0 | 10.5 | ns | C _L = 15 pF | OE | Q |
| | t _{ZL} | — | 5.5 | 11.0 | 1.0 | 12.5 | | C _L = 50 pF | | |
| Disable time | t _{HZ} | — | 3.4 | 9.0 | 1.0 | 10.5 | ns | C _L = 15 pF | OE | Q |
| | t _{LZ} | — | 4.0 | 10.1 | 1.0 | 11.5 | | C _L = 50 pF | | |
| Setup time | t _{SU} | 3.5 | — | — | 3.5 | — | ns | | Data before CLK ↑ | |
| Hold time | t _H | 1.5 | — | — | 1.5 | — | ns | | Data after CLK ↑ | |
| Pulse width | t _w | 5.0 | — | — | 5.0 | — | ns | | CLK: "H" or "L" | |

Output-skew Characteristics

$C_L = 50 \text{ pF}$

| Item | Symbol | $V_{CC} = (V)$ | $T_a = 25^\circ\text{C}$ | | $T_a = -40 \text{ to } 85^\circ\text{C}$ | | Unit |
|-------------|-------------|----------------|--------------------------|-----|------------------------------------------|-----|------|
| | | | Min | Max | Min | Max | |
| Output skew | $t_{sk(O)}$ | 2.3 to 2.7 | — | 2.0 | — | 2.0 | ns |
| | | 3.0 to 3.6 | — | 1.5 | — | 1.5 | |
| | | 4.5 to 5.5 | — | 1.0 | — | 1.0 | |

Note: Skew between any outputs of the same package switching in the same direction. This parameter is warranted but not production tested.

Operating Characteristics

$C_L = 50 \text{ pF}$

| Item | Symbol | $V_{CC} = (V)$ | $T_a = 25^\circ\text{C}$ | | | Unit | Test Conditions |
|-------------------------------|----------|----------------|--------------------------|------|-----|------|----------------------|
| | | | Min | Typ | Max | | |
| Power dissipation capacitance | C_{PD} | 3.3 | — | 21.1 | — | pF | $f = 10 \text{ MHz}$ |
| | | 5.0 | — | 22.8 | — | | |

Noise Characteristics

$C_L = 50 \text{ pF}$

| Item | Symbol | $V_{CC} = (V)$ | $T_a = 25^\circ\text{C}$ | | | Unit | Test Conditions |
|----------------------------------------|-------------|----------------|--------------------------|------|------|------|-----------------|
| | | | Min | Typ | Max | | |
| Quiet output, maximum dynamic V_{OL} | $V_{OL(P)}$ | 3.3 | — | 0.6 | 0.8 | V | |
| Quiet output, minimum dynamic V_{OL} | $V_{OL(V)}$ | 3.3 | — | -0.5 | -0.8 | V | |
| Quiet output, minimum dynamic V_{OH} | $V_{OH(V)}$ | 3.3 | — | 2.9 | — | V | |
| High-level dynamic input voltage | $V_{IH(D)}$ | 3.3 | 2.31 | — | — | V | |
| Low-level dynamic input voltage | $V_{IL(D)}$ | 3.3 | — | — | 0.99 | V | |

Test Circuit

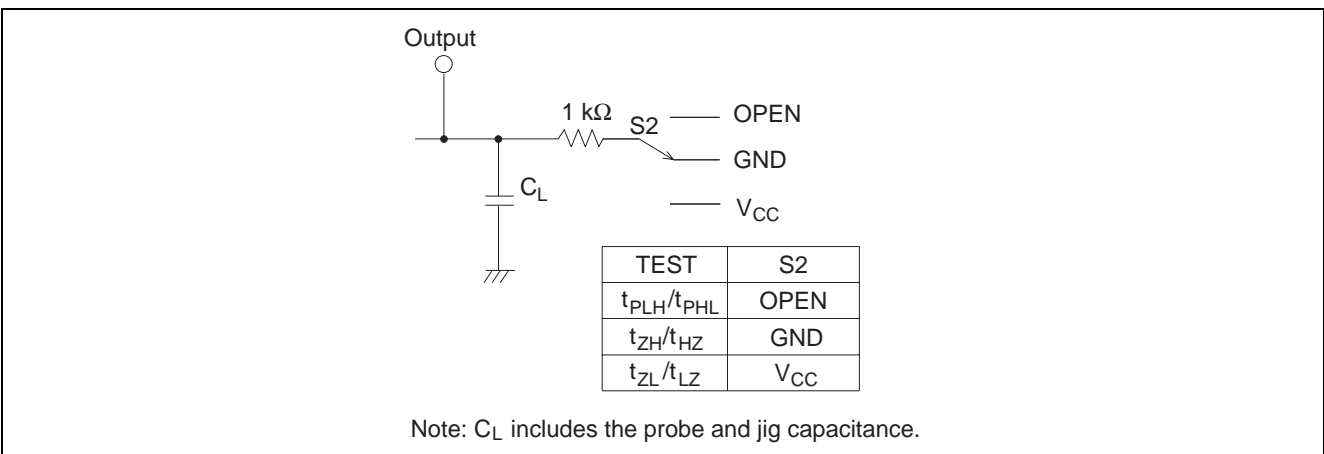

• Waveform – 1

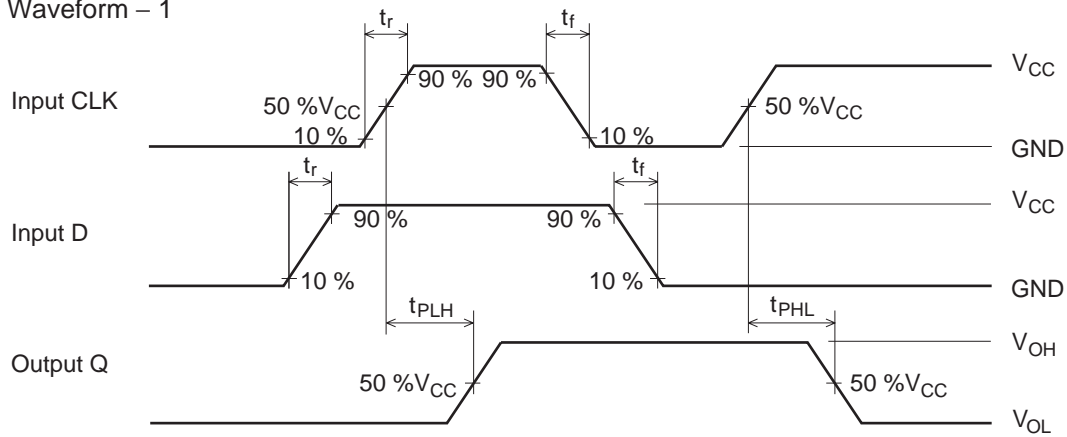

• Waveform – 2

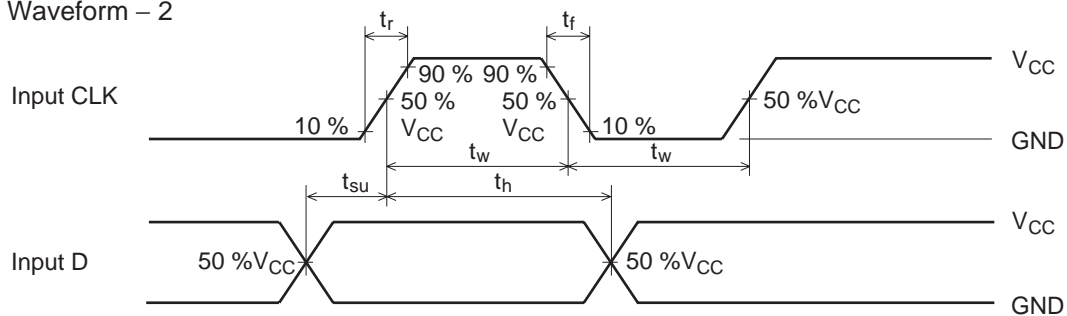

• Waveform – 3

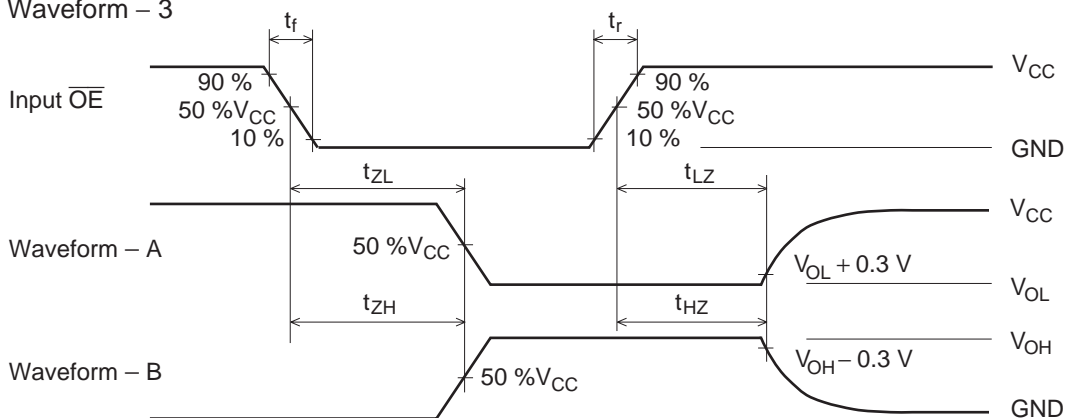

- Notes:
1. $t_r \leq 3 \text{ ns}$, $t_f \leq 3 \text{ ns}$
 2. Input waveform: $\text{PRR} \leq 1 \text{ MHz}$, duty cycle 50%
 3. Waveform-A is for an output with internal conditions such that the output is low except when disabled by the output control.
 4. Waveform-B is for an output with internal conditions such that the output is high except when disabled by the output control.

Package Dimensions

| | | | |
|-----------------------|--------------|---------------|------------|
| JEITA Package Code | RENESAS Code | Previous Code | MASS[Typ.] |
| P-SOP20-5.5x12.6-1.27 | PRSP0020DD-B | FP-20DAV | 0.31g |

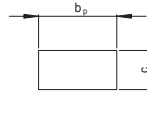
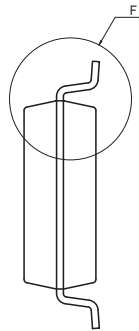
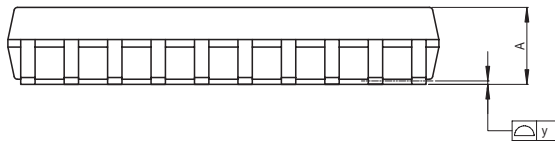
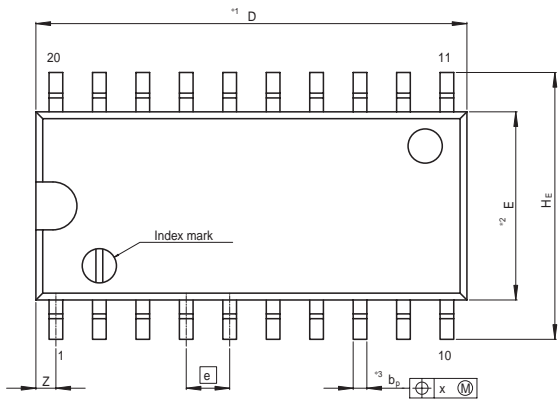

Terminal cross section (Ni/Pd/Au plating)

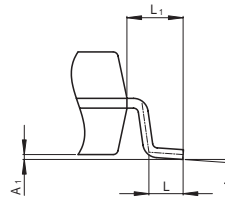

Detail F

NOTE)
 1. DIMENSIONS*1 (Nom)*AND*2*
 DO NOT INCLUDE MOLD FLASH.
 2. DIMENSION*3*DOES NOT
 INCLUDE TRIM OFFSET.

| Reference Symbol | Dimension in Millimeters | | |
|------------------|--------------------------|-------|------|
| | Min | Nom | Max |
| D | — | 12.60 | 13.0 |
| E | — | 5.50 | — |
| A ₂ | — | — | — |
| A ₁ | 0.00 | 0.10 | 0.20 |
| A | — | — | 2.20 |
| b _p | 0.34 | 0.40 | 0.46 |
| b ₁ | — | — | — |
| c | 0.15 | 0.20 | 0.25 |
| c ₁ | — | — | — |
| | 0° | — | 8° |
| H _E | 7.50 | 7.80 | 8.00 |
| e | — | 1.27 | — |
| x | — | — | 0.12 |
| y | — | — | 0.15 |
| Z | — | — | 0.80 |
| L | 0.50 | 0.70 | 0.90 |
| L ₁ | — | 1.15 | — |

| | | | |
|------------------------|--------------|---------------|------------|
| JEITA Package Code | RENESAS Code | Previous Code | MASS[Typ.] |
| P-TSSOP20-4.4x6.5-0.65 | PTSP0020JB-A | TTP-20DAV | 0.07g |

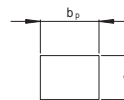
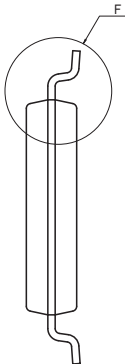
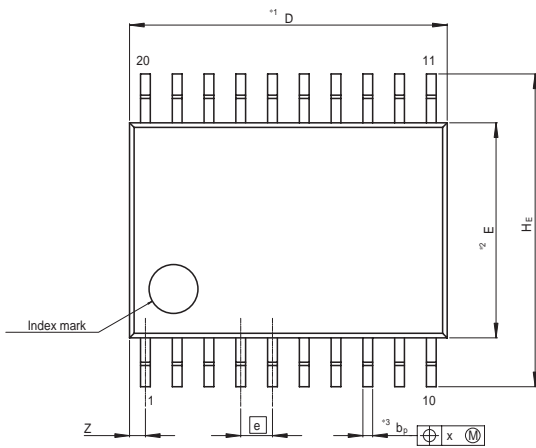

Terminal cross section (Ni/Pd/Au plating)

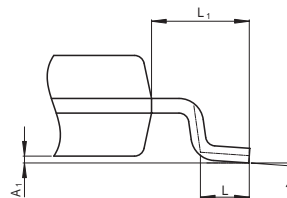

Detail F

NOTE)
 1. DIMENSIONS*1 (Nom)*AND*2*
 DO NOT INCLUDE MOLD FLASH.
 2. DIMENSION*3*DOES NOT
 INCLUDE TRIM OFFSET.

| Reference Symbol | Dimension in Millimeters | | |
|------------------|--------------------------|------|------|
| | Min | Nom | Max |
| D | — | 6.50 | 6.80 |
| E | — | 4.40 | — |
| A ₂ | — | — | — |
| A ₁ | 0.03 | 0.07 | 0.10 |
| A | — | — | 1.10 |
| b _p | 0.15 | 0.20 | 0.25 |
| b ₁ | — | — | — |
| c | 0.10 | 0.15 | 0.20 |
| c ₁ | — | — | — |
| | 0° | — | 8° |
| H _E | 6.20 | 6.40 | 6.60 |
| e | — | 0.65 | — |
| x | — | — | 0.13 |
| y | — | — | 0.10 |
| Z | — | — | 0.65 |
| L | 0.4 | 0.5 | 0.6 |
| L ₁ | — | 1.0 | — |

RENESAS Technology Corp. Sales Strategic Planning Div. Nippon Bldg., 2-6-2, Ohte-machi, Chiyoda-ku, Tokyo 100-0004, Japan

Keep safety first in your circuit designs!

1. Renesas Technology Corp. puts the maximum effort into making semiconductor products better and more reliable, but there is always the possibility that trouble may occur with them. Trouble with semiconductors may lead to personal injury, fire or property damage.
Remember to give due consideration to safety when making your circuit designs, with appropriate measures such as (i) placement of substitutive, auxiliary circuits, (ii) use of nonflammable material or (iii) prevention against any malfunction or mishap.

Notes regarding these materials

1. These materials are intended as a reference to assist our customers in the selection of the Renesas Technology Corp. product best suited to the customer's application; they do not convey any license under any intellectual property rights, or any other rights, belonging to Renesas Technology Corp. or a third party.
2. Renesas Technology Corp. assumes no responsibility for any damage, or infringement of any third-party's rights, originating in the use of any product data, diagrams, charts, programs, algorithms, or circuit application examples contained in these materials.
3. All information contained in these materials, including product data, diagrams, charts, programs and algorithms represents information on products at the time of publication of these materials, and are subject to change by Renesas Technology Corp. without notice due to product improvements or other reasons. It is therefore recommended that customers contact Renesas Technology Corp. or an authorized Renesas Technology Corp. product distributor for the latest product information before purchasing a product listed herein.
The information described here may contain technical inaccuracies or typographical errors.
Renesas Technology Corp. assumes no responsibility for any damage, liability, or other loss rising from these inaccuracies or errors.
Please also pay attention to information published by Renesas Technology Corp. by various means, including the Renesas Technology Corp. Semiconductor home page (<http://www.renesas.com>).
4. When using any or all of the information contained in these materials, including product data, diagrams, charts, programs, and algorithms, please be sure to evaluate all information as a total system before making a final decision on the applicability of the information and products. Renesas Technology Corp. assumes no responsibility for any damage, liability or other loss resulting from the information contained herein.
5. Renesas Technology Corp. semiconductors are not designed or manufactured for use in a device or system that is used under circumstances in which human life is potentially at stake. Please contact Renesas Technology Corp. or an authorized Renesas Technology Corp. product distributor when considering the use of a product contained herein for any specific purposes, such as apparatus or systems for transportation, vehicular, medical, aerospace, nuclear, or undersea repeater use.
6. The prior written approval of Renesas Technology Corp. is necessary to reprint or reproduce in whole or in part these materials.
7. If these products or technologies are subject to the Japanese export control restrictions, they must be exported under a license from the Japanese government and cannot be imported into a country other than the approved destination.
Any diversion or reexport contrary to the export control laws and regulations of Japan and/or the country of destination is prohibited.
8. Please contact Renesas Technology Corp. for further details on these materials or the products contained therein.



RENESAS SALES OFFICES

<http://www.renesas.com>

Refer to "<http://www.renesas.com/en/network>" for the latest and detailed information.

Renesas Technology America, Inc.

450 Holger Way, San Jose, CA 95134-1368, U.S.A
Tel: <1> (408) 382-7500, Fax: <1> (408) 382-7501

Renesas Technology Europe Limited

Dukes Meadow, Millboard Road, Bourne End, Buckinghamshire, SL8 5FH, U.K.
Tel: <44> (1628) 585-100, Fax: <44> (1628) 585-900

Renesas Technology Hong Kong Ltd.

7th Floor, North Tower, World Finance Centre, Harbour City, 1 Canton Road, Tsimshatsui, Kowloon, Hong Kong
Tel: <852> 2265-6688, Fax: <852> 2730-6071

Renesas Technology Taiwan Co., Ltd.

10th Floor, No.99, Fushing North Road, Taipei, Taiwan
Tel: <886> (2) 2715-2888, Fax: <886> (2) 2713-2999

Renesas Technology (Shanghai) Co., Ltd.

Unit2607 Ruijing Building, No.205 Maoming Road (S), Shanghai 200020, China
Tel: <86> (21) 6472-1001, Fax: <86> (21) 6415-2952

Renesas Technology Singapore Pte. Ltd.

1 Harbour Front Avenue, #06-10, Keppel Bay Tower, Singapore 098632
Tel: <65> 6213-0200, Fax: <65> 6278-8001