



Micro Commercial Components
 21201 Itasca Street Chatsworth
 CA 91311
 Phone: (818) 701-4933
 Fax: (818) 701-4939

HDBS101G THRU HDBS107G

Features

- High Forward Surge Capability
- Ideal for printed circuit boards
- High Temperature Soldering: 250°C for 10 seconds
- Reliable low cost construction utilizing molded plastic technique

Maximum Ratings

- Operating Temperature: -55°C to +150°C
- Storage Temperature: -55°C to +150°C
- For Capacitive Load, Derate Current by 20%

MCC Part Number	Maximum Recurrent Peak Reverse Voltage	Maximum RMS Voltage	Maximum DC Blocking Voltage
HDBS101G	50V	35V	50V
HDBS102G	100V	70V	100V
HDBS103G	200V	140V	200V
HDBS104G	400V	280V	400V
HDBS105G	600V	420V	600V
HDBS106G	800V	560V	800V
HDBS107G	1000V	700V	1000V

1.0 AMP. Glass Passivated Bridge High Efficient Rectifier 50 to 1000 Volts

SDB-1

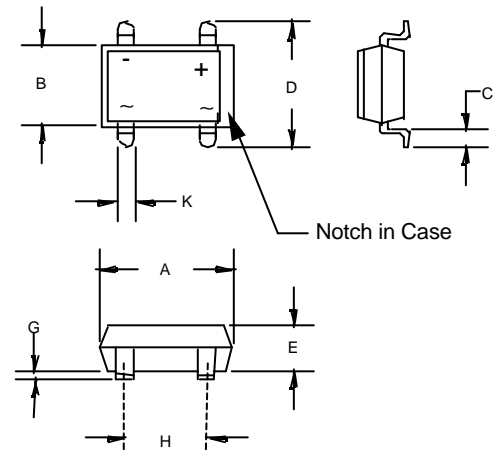

Electrical Characteristics @ 25°C Unless Otherwise Specified

Average Forward Current	$I_{F(AV)}$	1.0 A	$T_C = 40^\circ\text{C}$
Peak Forward Surge Current	I_{FSM}	50A	8.3ms, half sine $T_J=150^\circ\text{C}$
Maximum Instantaneous Forward Voltage HDBS101G-103G HDBS104G HDBS105G-107G	V_F	1.0V 1.3V 1.7V	$I_{FM} = 1.0\text{A};$ $T_C = 25^\circ\text{C}$
Maximum DC Reverse Current At Rated DC Blocking Voltage	I_R	5.0μA 500uA	$T_C = 25^\circ\text{C}$ $T_C = 125^\circ\text{C}$
Maximum Reverse Recovery Time HDBS101G-104G HDBS105G-107G	T_{rr}	50ns 75ns	$I_F=0.5\text{A}, I_R=1.0\text{A},$ $I_r=0.25\text{A}$

DIM	INCHES		MM		NOTE
	MIN	MAX	MIN	MAX	
A	.320	.335	8.13	8.50	
B	.245	.255	6.20	6.50	
C	.040	.060	1.02	1.52	
D	.386	.404	9.80	10.3	
E	.120	.130	3.05	3.30	
G	.003	.013	0.076	0.33	
H	.195	.205	5.00	5.20	
K	.040	.047	1.02	1.20	TYP

Suggested Solder Pad Layout

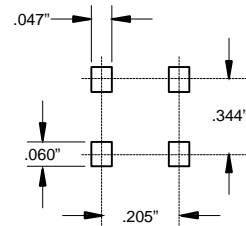

FIG. 1- REVERSE RECOVERY TIME CHARACTERISTIC AND TEST CIRCUIT DIAGRAM

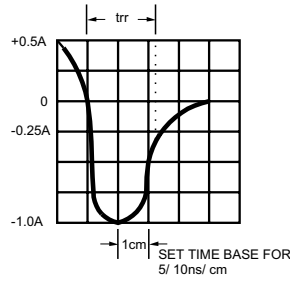
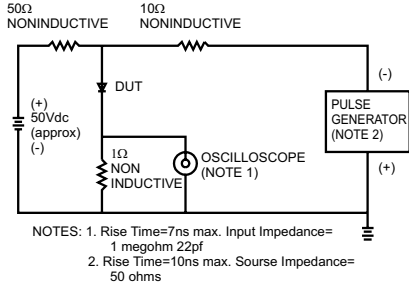

FIG. 2- MAXIMUM FORWARD CURRENT DERATING CURVE

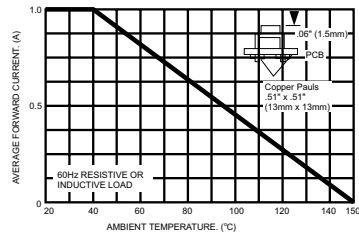

FIG. 3- TYPICAL REVERSE CHARACTERISTICS

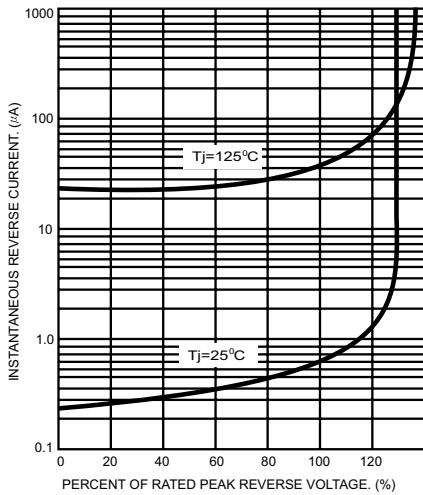

FIG. 4- TYPICAL FORWARD CHARACTERISTICS

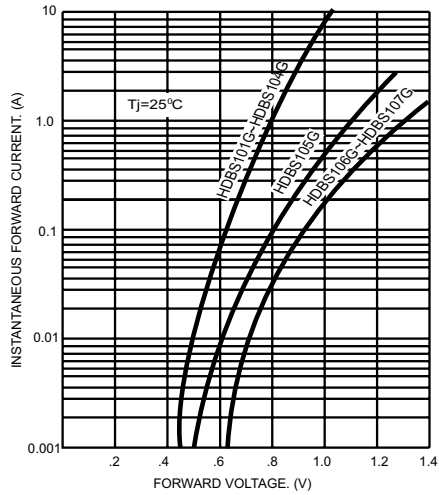

FIG. 5- MAXIMUM NON-REPETITIVE FORWARD SURGE CURRENT

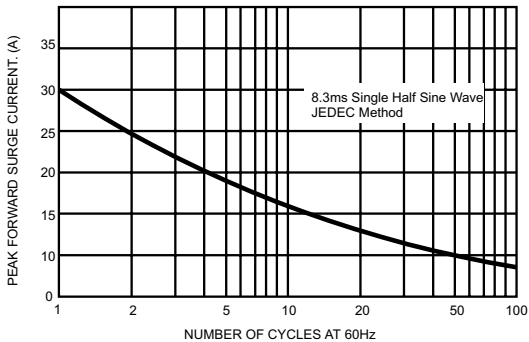

FIG. 6- TYPICAL JUNCTION CAPACITANCE

