

液晶之友 电话: 020-33819057
Http://www.lcdfriends.com

HANTRONIX

PRODUCT SPECIFICATION

HDM3224

320x240 GRAPHICS
LCD DISPLAY MODULE

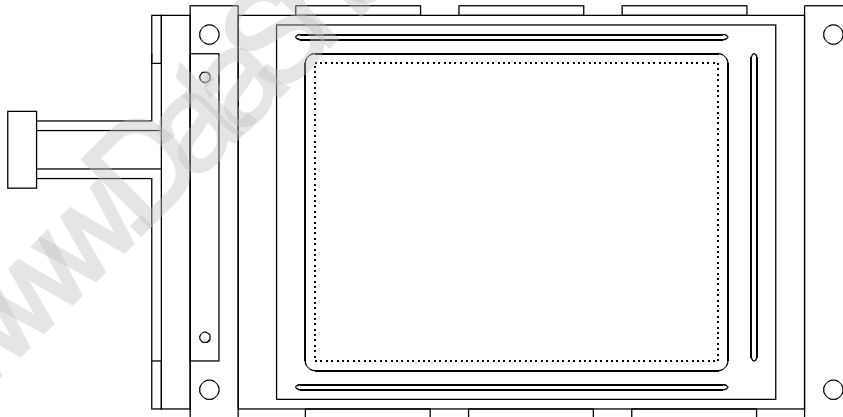

HANTRONIX, INC.
10080 BUBB RD.
CUPERTINO, CA 95014

Q.A.:
JB

REV.:
1.0

HDM3224

SHEET 1 OF 10
DATE:
9/14/98

1. FEATURES

3224-4-A4000 is a low-power consumption LCD module with a high contrast LCD panel.

- 1) Driving method : 1/240 duty
- 2) Display mode : STN Yellow
- 3) Display type : Positive
- 4) Data transfer rate : 4.0 MHz
- 5) EL Backlight (White)
- 6) X/Y Driver : HD66204 / HD66205 -- QFP TYPE

2. MECHANICAL DATA

Module size - - - - - 143.0W X 96.8H X 12.0T mm
 Min. viewing area - - - - - 104W X 79.3H mm
 Active viewing area - - - - - 95.97W X 71.97H mm
 Number of dots - - - - - 320W X 240H dots
 Dot size - - - - - 0.27W X 0.27H mm
 Dot pitch - - - - - 0.3W X 0.3H mm
 Weight - - - - - about 170 g

3. ABSOLUTE MAXIMUM RATINGS

ITEM	SYMBOL	TEST CONDITION	STANDARD VALUE		UNIT	
			MIN.	MAX.		
Power Supply	Logic	$V_{DD}-V_{SS}$	$T_a=25^{\circ}C$	0	7.0	V
	LCD Drive	$V_{DD}-V_{EE}$	$T_a=25^{\circ}C$	0	30.0	V
Input Voltage	V_I	$T_a=25^{\circ}C$	0	V_{DD}	V	
Operating Temperature	T_{OP}	-	0	40	$^{\circ}C$	
Storage Temperature	T_{STG}	-	-20	60	$^{\circ}C$	

4. ELECTRICAL CHARACTERISTICS

ITEM	SYMBOL	TEST CONDITION	STANDARD VALUE			UNIT
			MIN.	TYP.	MAX.	
Supply Voltage	V_{DD}	-	4.5	5.0	5.5	V
	V_{EE}	-	-	- 17.5	-	V
Power Supply Current	I_{DD}	$V_{DD} = 5.0 V$	-	8.0	16.0	mA
	- I_{EE}	$V_{EE} = -17.5V$	-	7.0	14.0	mA
Input High Voltage	V_{IH}	-	4.2	-	5.0	V
Input Low Voltage	V_{IL}	-	0	-	+ 0.8	V
Brightness	B	$V_{EL}=100V(AC)$ $f_{EL}=400 Hz$	8.5	10.0	-	NIT
Frame Frquency	f_{FP}	-	65	72	80	Hz
Power supply for LCD (NOTE)	$V_{DD}-V_L$	$T_a= 25^{\circ}C$	-	23.5	-	V

Note : Power supply for LCD is available with R_L in accordance with contrast.

HANTRONIX, INC. 10080 BUBB RD. CUPERTINO, CA 95014	Q.A.:	REV.:	HDM3224	SHEET 2 OF 10
	JB	1.0		DATE: 9/14/98

ELECTRO-OPTICAL CHARACTERISTICS

(Ta = 25 °C)

ITEM	SYMBOL	CONDITION	MIN.	TYP.	MAX.	UNIT	NOTE
Viewing angle	$\phi_2 - \phi_1$	K = 2.0	50	-	-	deg.	1, 2
	θ		-40	-	+40		
Contrast ratio	K	$\phi=20^\circ, \theta=0^\circ$	-	10	-	-	3
Response time (rise)	T_r	$\phi=20^\circ, \theta=0^\circ$	-	200	250	mS	4
Response time (fall)	T_f	$\phi=20^\circ, \theta=0^\circ$	-	250	350	mS	4

NOTE1. Definition of angle θ and ϕ

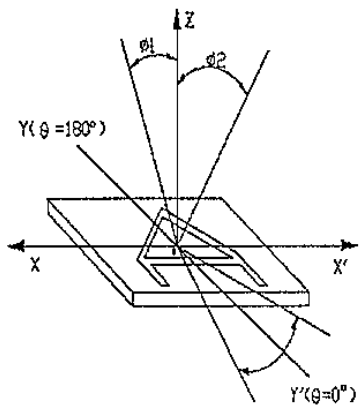

NOTE2. Definition viewing angle ϕ_1 and ϕ_2

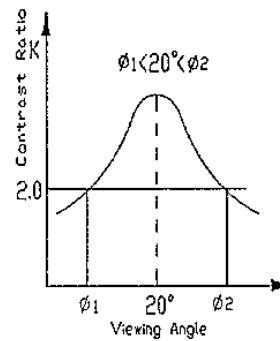

NOTE3. Definition of contrast K

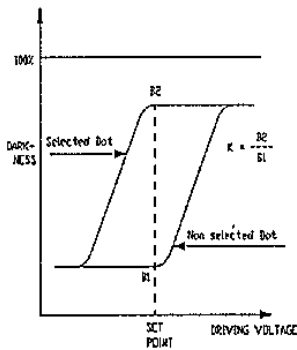

NOTE4. Definition of optical response

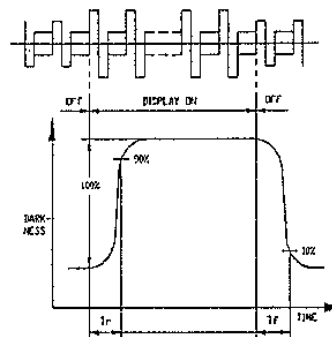

HANTRONIX, INC.
10080 BUBB RD.
CUPERTINO, CA 95014

Q.A.:
JB

REV.:
1.0

HDM3224

SHEET 3 OF 10

DATE:
9/14/98

BLOCK DIAGRAM

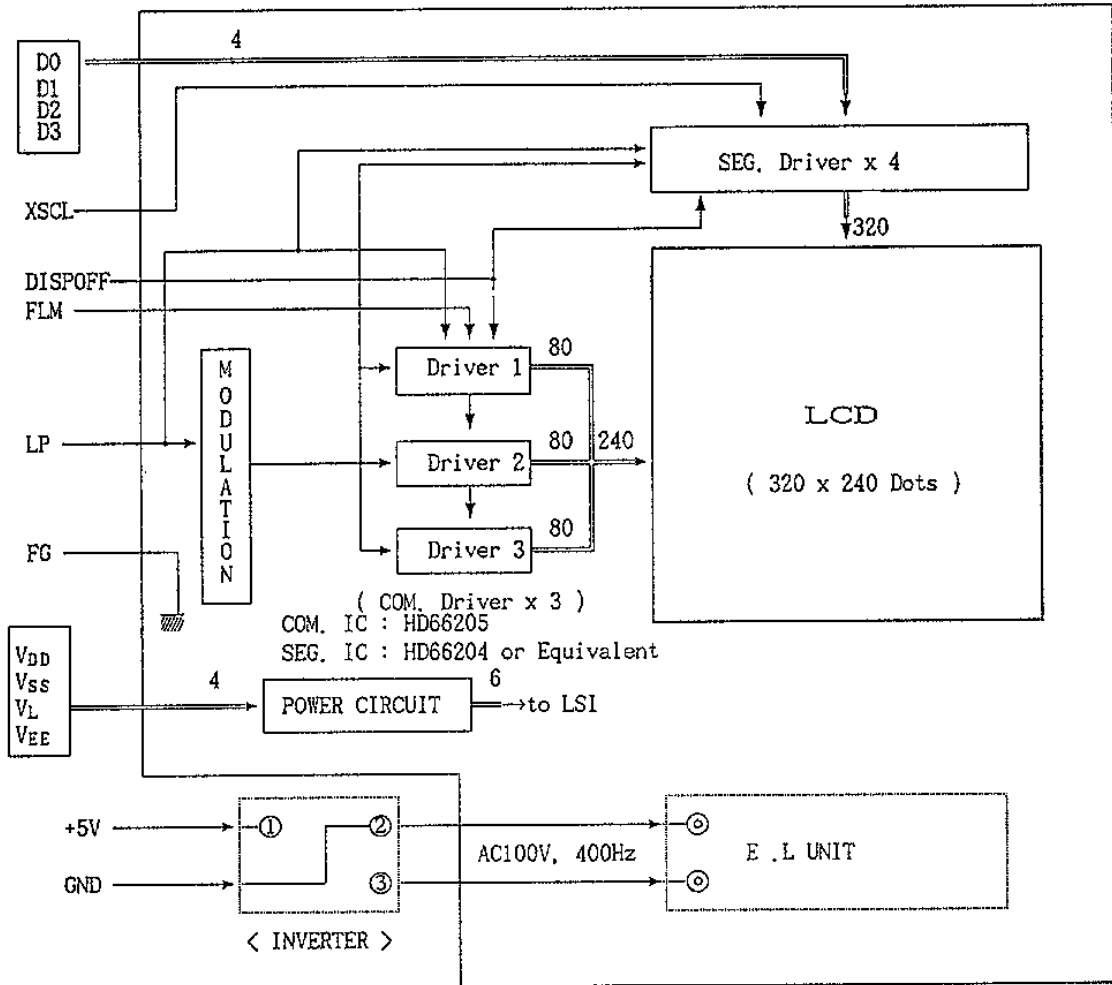

11. POWER SUPPLY

(DOUBLE POWER)

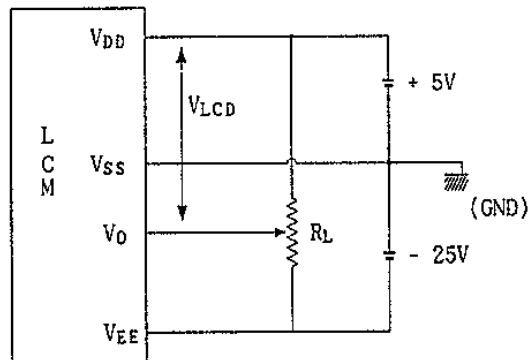

($R_L = 10 \sim 20 \text{ Kohm}$)

HANTRONIX, INC.
 10080 BUBB RD.
 CUPERTINO, CA 95014

Q.A.:
 JB

REV.:
 1.0

HDM3224

SHEET 4 OF 10

DATE:
 9/14/98

TIMING CHARACTERISTICS
TIMING CHART

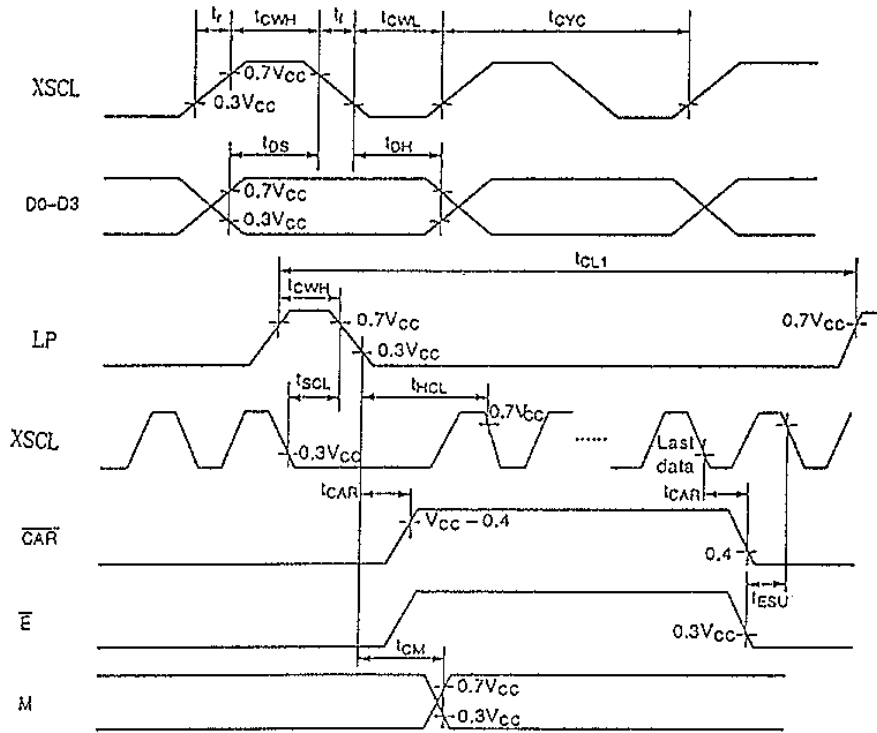

TIMING TYPICAL

Item	Symbol	Min.	Typ.	Max.	Unit
Clock Frequency	fscp	-	-	6	M Hz
SCP Pulse Width	tcwH, tcwL	60	-	-	n s
Rise / Fall Time	tr, tf	-	-	30	n s
Data Set up Time	tDSU	30	-	-	n s
Data Hold Time	tDHD	30	-	-	n s
LP Set up Time	tLSU	60	-	-	n s
LP Hold Time	tLHD	70	-	-	n s
LP Pulse Width	tLWH	60	-	-	n s
Clock Margin Time (SCP -> LP)	tSL	20	-	-	n s
Clock Margin Time (LP -> SCP)	tLS	20	-	-	n s
FP Set Up Time	tFSU	10	-	-	n s
FP Hold Time	tFHD	40	-	-	n s
FP Frequency	fFP	70	72	145	Hz

HANTRONIX, INC.
10080 BUBB RD.
CUPERTINO, CA 95014

Q.A.:
JB

REV.:
1.0

HDM3224

SHEET 5 OF 10

DATE:
9/14/98

TIMING DIAGRAM

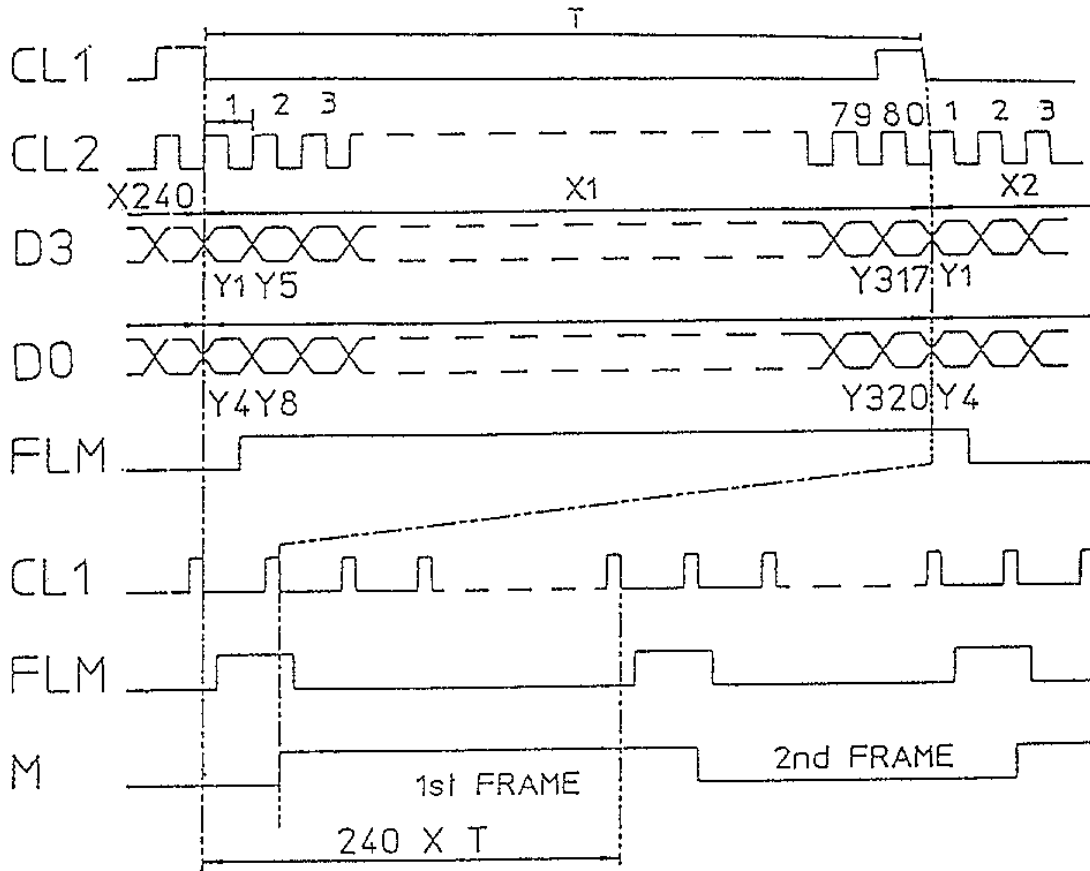

DATA MAP

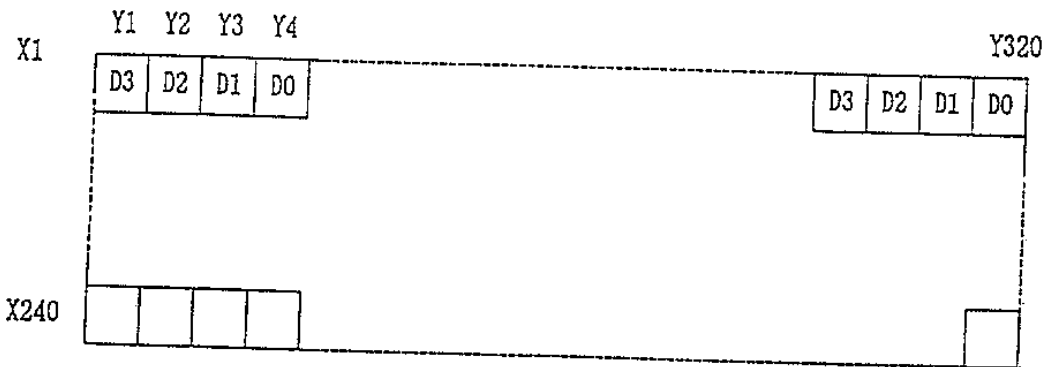

HANTRONIX, INC.
10080 BUBB RD.
CUPERTINO, CA 95014

Q.A.:
JB

REV.:
1.0

HDM3224

SHEET 6 OF 10

DATE:
9/14/98

ELECTRO-LUMINESCENT LAMP (E. L)

- 1) Several color can be obtained by using wavelength transfer materials.
White, Blue-Green, Green, Orange, Blue and Red are available.
- 2) INVERTER shall be used to drive E.L in case of BATTERY operation or DC voltage.
- 3) Recommended INVERTER : 5E (Manufacture : JAPAN ELSTAR CO., LTD.)
- 4) Brightness : MIN. 30 NIT (Measured on the bare E.L)
- 5) Connection method with the INVERTER.

UNIT : mm

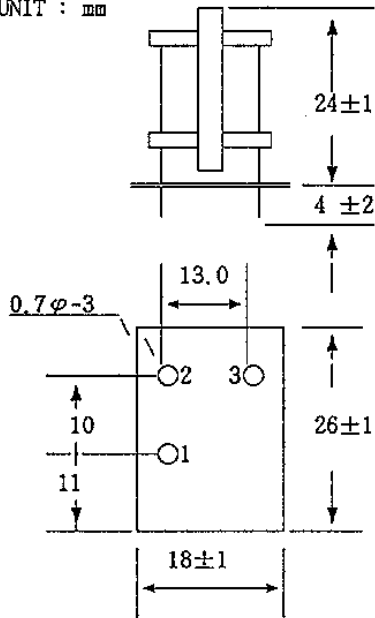

*** PIN CONNECTION**

PIN NO.	DESCRIPTION
1	DC + 5V input
2	Common (GND & output)
3	Output

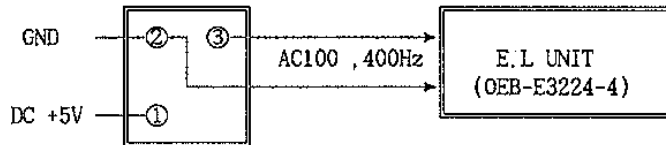

- 5) Life time according to the environmental condition (unit : HOURS)

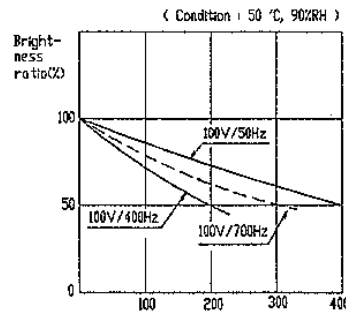
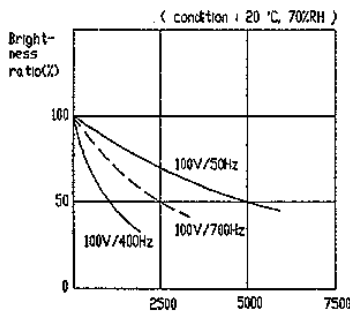

NOTE : ————— ; constant voltage / frequency drive
 - - - - - ; inverter drive

HANTRONIX, INC. 10080 BUBB RD. CUPERTINO, CA 95014	Q.A.:	REV.:	HDM3224	SHEET 7 OF 10
	JB	1.0		DATE:

Temperature characteristics

* Operating temperature range : from 0°C to 50°C

* Storing temperature range : from -20°C to 60°C

Electrical characteristics

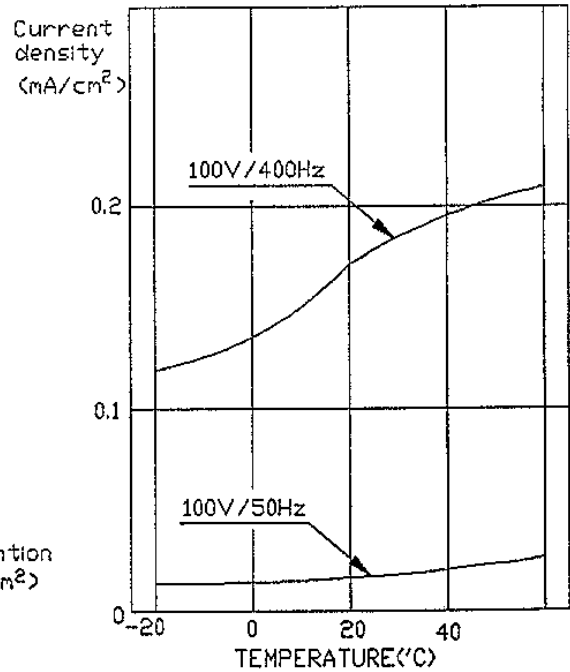
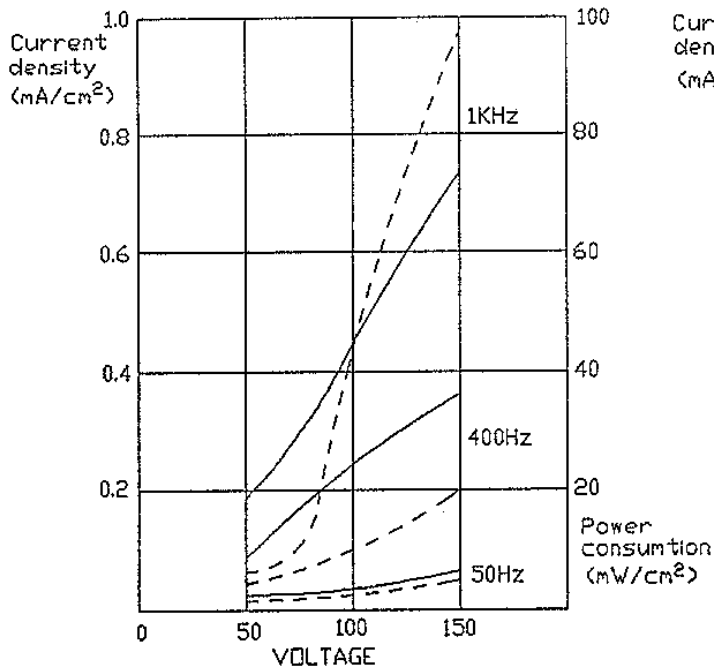
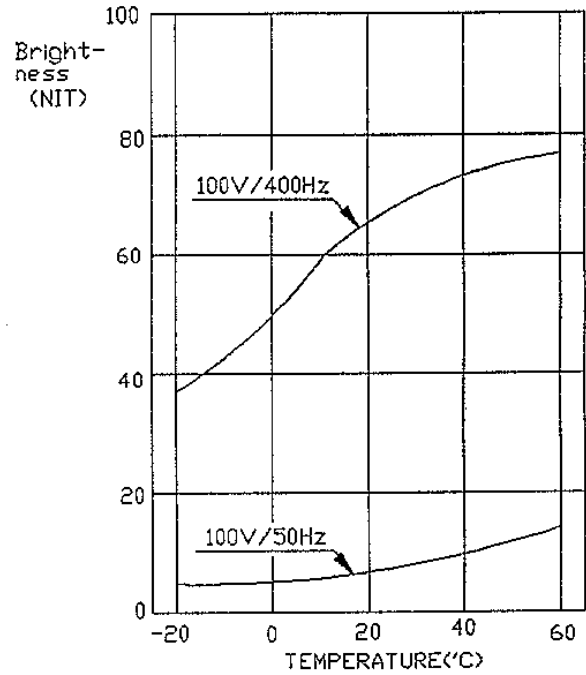
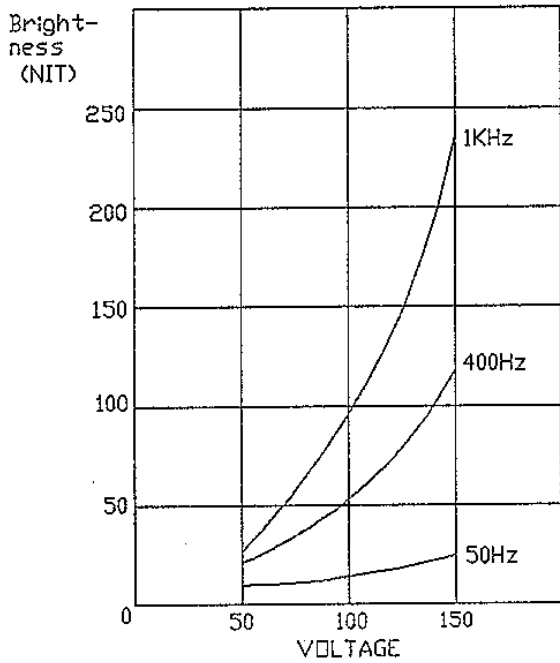

NOTE : ——— : current density
 - - - - : power consumption

HANTRONIX, INC.
 10080 BUBB RD.
 CUPERTINO, CA 95014

Q.A.:
 JB

REV.:
 1.0

HDM3224

SHEET 8 OF 10

DATE:
 9/14/98

PRECAUTION FOR USING
HANDLING

- 1) Refrain from storing mechanical shock and from applying any force to LCD MODULE.
It may cause misoperation or damage of LCD.
- 2) Do not touch, press or rub the display panel with a hard, stiff tool or object as the polarizers in the panel are easily scratched.
- 3) If LCD is broken and liquid crystal material flow out, ingestion, inhalation, or contact with skin should be avoided. If liquid crystal material contact with skin, wash immediately with alcohol and rinse thoroughly with water.
- 4) Never use organic solvents to clear the display panel as these solvent may adversely affect the polarizer. To clean the display panel dampen a bit of absorbent cotton with petroleum benzene and gently wipe the panel, or contaminations by using a scotch tape.
- 5) Refrain from discharge of high electro-static voltage, it will damage C-MOS LSI in the MODULE.
- 6) Do not leave the MODULE in high temperature, especially in high humidity for a long time. It is recommended to store the MODULE where the temperature is in the range of 0°C to 35°C and the humidity is lower than 70%.
- 7) Store the MODULE without exposure to direct sunlight or fluorescent lamp.
- 8) Ultra violet cut filter is necessary for outdoor operation.
- 9) Avoid condensation of water, it may cause misoperation or disconnection of electrode.

OPERATION

- 1) Never connect or disconnect the LCD MODULE from the main system while power is being supplied.
- 2) When supplying the M signal from the external unit to a GRAPHIC MODULE, set the duty to 50%±1%.
If the duty deviates too greatly from the value, a DC voltage will be applied to the liquid crystal, which could induce an electrochemical reaction and reduce the life of the MODULE.
- 3) Do not exceed the maximum rating values under the worst conditions taking account of the supply voltage variation, input voltage variation, and environmental temperature, etc. Otherwise LCD module may be damaged.

HANTRONIX, INC. 10080 BUBB RD. CUPERTINO, CA 95014	Q.A.:	REV.:	HDM3224	SHEET 9 OF 10
	JB	1.0		DATE: 9/14/98

DISPLAY PATTERN

Unit : mm

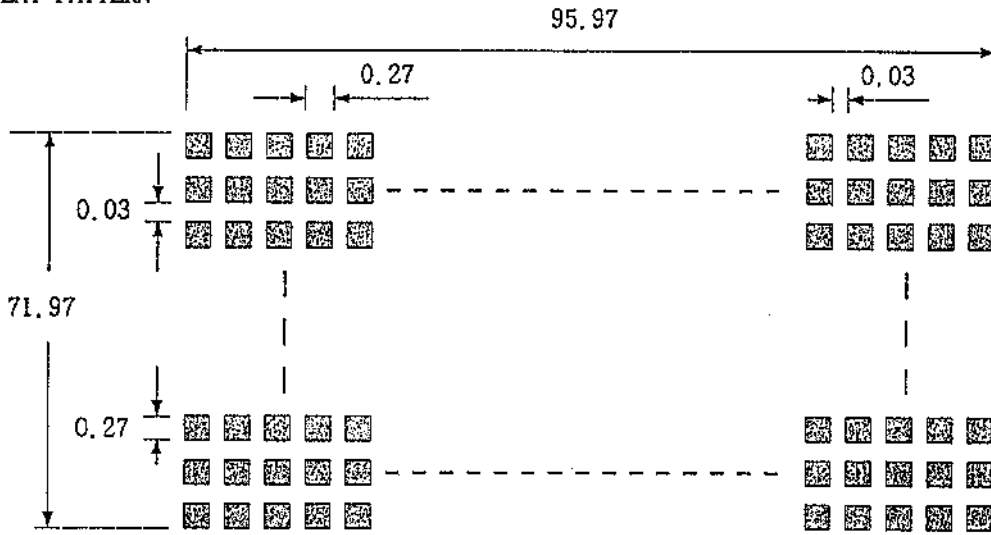

EXTERNAL DIMENSION

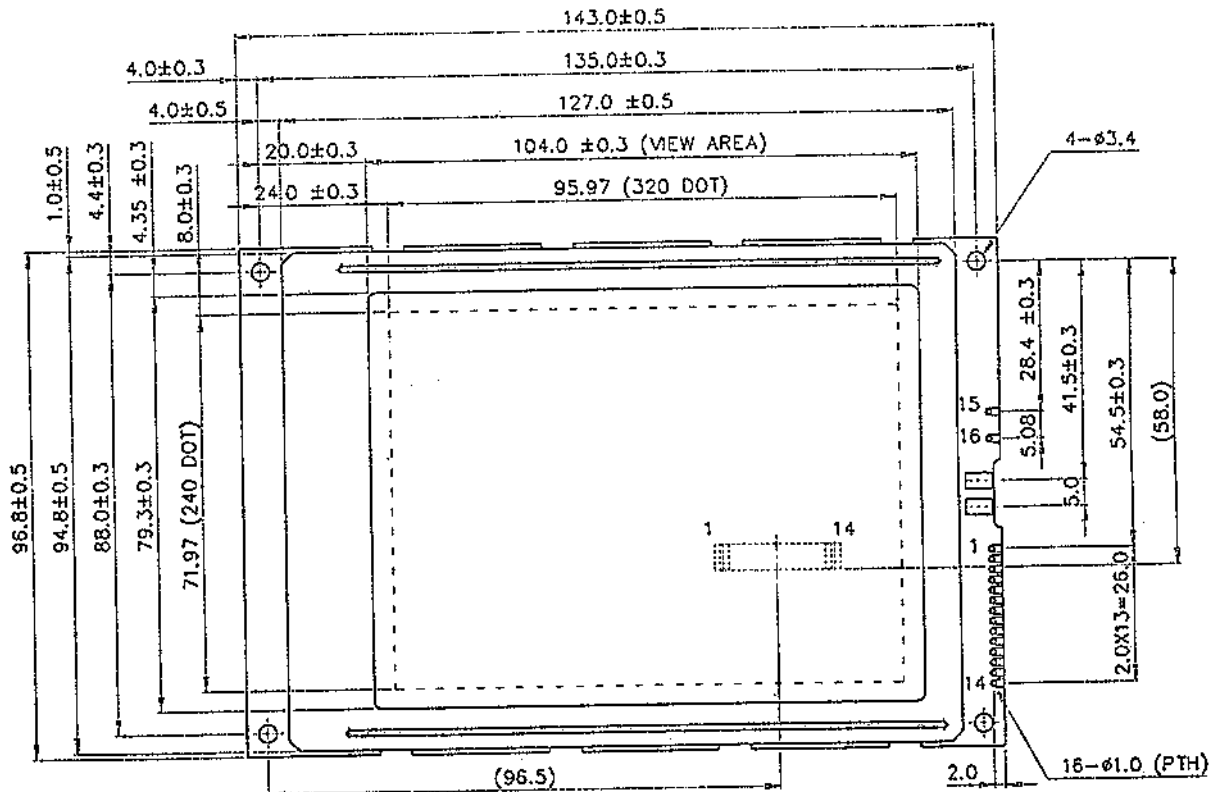

HANTRONIX, INC.
10080 BUBB RD.
CUPERTINO, CA 95014

Q.A.:
JB

REV.:
1.0

HDM3224

SHEET 10 OF 10
DATE: 9/14/98