

液晶之友 电话: 020-33819057
Http://www.lcdfriends.com

HANTRONIX

PRODUCT SPECIFICATION

HDM6448-1

640 x 480 GRAPHICS
LCD DISPLAY MODULE

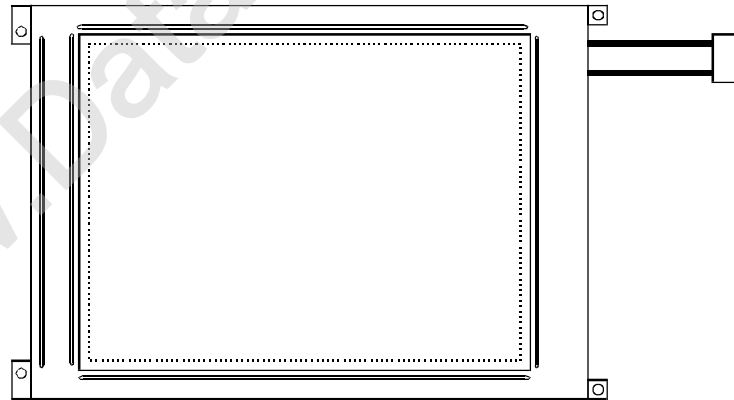

HANTRONIX, INC. 10080 BUBB RD. CUPERTINO, CA 95014	Q.A.:	REV.:	HDM6448-1	SHEET 1 OF 15
	JB	1.0		DATE: 7/28/00

MECHANICAL DATA

(1) Product No. **HDM6448-1**
(2) Module Size 260.0 (W)mm x 174.0 (H)mm x MAX8.0 (D)mm
(3) Dot Size 0.27 (W)mm x 0.27 (H)mm
(4) Dot Pitch 0.30 (W)mm x 0.30 (H)mm
(5) Number of Dots 640 (W) x 480 (H)Dots
(7) Duty 1/240
(8) LCD Display Mode STN: Bule Mode
FSTN: Black and White(Normally White/Positive Image)
 Black and White(Normally Black/Negative Image)
Rear Polarizer: Reflective Transflective Transmissive
 Transflective (High Transmissive)
(9) Viewing Direction 6 O'clock 12 O'clock ____O'clock
(10) Backlight CCFL
(11) Weight W/O B/L: about 348 g
CCFL B/L: about 353.5 g

HANTRONIX, INC. 10080 BUBB RD. CUPERTINO, CA 95014	Q.A.: JB	REV.: 1.0	HDM6448-1	SHEET 2 OF 15
				DATE: 7/28/00

ABSOLUTE MAXIMUM RATINGS

(1) ELECTRICAL ABSOLUTE RATINGS

VSS=0 V Standard

ITEM	SYMBOL	MIN	MAX	UNIT	COMMENT
Power Supply for Logic	VDD-VSS	-0.3	6.5	V	
Input Voltage	VDD-VEE	0	27	V	
Static Electricity	-	-	-	-	Note 1

Note 1 LCM should be grounded during handling LCM.

(2) ENVIRONMENTAL ABSOLUTE MAXIMUM RATINGS

ITEM	NORMAL TEMP.			
	OPERATING		STORAGE	
	MIN.	MAX.	MIN.	MAX.
Ambient Temperature	0	50	-25	60
Humidity (Without Condensation)	Note 2,4		Note 3,4	
Vibration(Note ※)	-		49m/s ² (5G)	

Note 2 Ta ≤ 50°C : 85%RH max

Ta > 50°C : Absolute humidity must be lower

than the humidity of 85%RH at 50°C

Note 3 Ta at -25°C will be < 48 hrs, at 60°C will be < 120 hrs

Note 4 Background color will change slightly depending on ambient temperature.

That phenomenon is reversible.

Note※

Frequency (HZ)	10~55~10/1 min
Vibration Width	1.5 m/m
Vibration Direction	X/Y/Z
Vibration Time	15 min-1cycle X 3 directions

HANTRONIX, INC. 10080 BUBB RD. CUPERTINO, CA 95014	Q.A.:	REV.:	HDM6448-1	SHEET 3 OF 15
	JB	1.0		DATE:

ELECTRICAL CHARACTERISTICS

ITEM	SYMBOL	CONDITION	MIN.	TYP.	MAX.	UNIT	
Power Supply for Logic	VDD-VSS	-	2.7	3.0	3.3	V	
			4.75	5.0	5.25		
Input Voltage	VIL	L level	0	-	0.2VDD	V	
	VIH	H level	0.8VDD	-	VDD	V	
LCM Recommend LCD Module Driving Voltage	VDD-VEE	VDD=5V Duty=1/240 Bias=1/13	0°C	23.4	23.8	24.2	V
			25°C	22.2	22.6	23.0	
			50°C	20.9	21.3	21.7	
Power Supply Current for LCM	IDD	VDD=5.0V VDD-VEE=22.6V FLM=70Hz	-	30	-	mA	
	IEE		-	20	-		
Power Supply Current for CCFL B.L.	ICCFL	450 Vrms 30KHz	-	5	-	mA	

HANTRONIX, INC.
10080 BUBB RD.
CUPERTINO, CA 95014

Q.A.:
JB

REV.:
1.0

HDM6448-1

SHEET 4 OF 15

DATE:
7/28/00

OPTICAL CHARACTERISTICS

AT Vop

ITEM		Cr(Contrast Ratio)						θ (Viewing Angle)		ϕ (Viewing Angle)	
		0 τ		25 τ		50 τ		25 τ		25 τ	
		MIN.	TYP.	MIN.	TYP.	MIN.	TYP.	MIN.	TYP.	MIN.	TYP.
R	J	-	-	-	5.5	-	-	-	50	-	30
S	J	-	-	-	5.0	-	-	-	45	-	28
T	E	-	-	-	3.5	-	-	-	45	-	26
	G	-	6.5	-	8.0	-	4.5	-	40	-	55
NOTE		NOTE6						NOTE5			

NOTE :

R: REFLECTIVE
 S: TRANSFLECTIVE(Normal)
 T: TRANSMISSIVE

E: BLUE
 G: NORMALLY BLACK
 J: NORMALLY WHITE

AT $\phi=0^\circ$ $\theta=0^\circ$

ITEM	SYMBOL	CONDITION	MIN.	TYP.	MAX.	UNIT	NOTE
Response Time (rise)	Tr	0 τ	-	340	680	ms	NOTE 2
		25 τ	-	120	240		
		50 τ	-	90	180		
Response Time (fall)	Tr	0 τ	-	370	710	ms	NOTE 2
		25 τ	-	170	290		
		50 τ	-	80	170		

HANTRONIX, INC. 10080 BUBB RD. CUPERTINO, CA 95014	Q.A.:	REV.:	HDM6448-1	SHEET 5 OF 15
	JB	1.0		DATE:

(NOTE 1)

Definition of Operation Voltage(Vop)

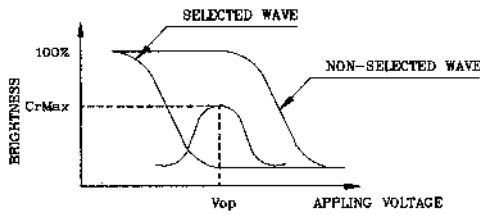

(positive type)

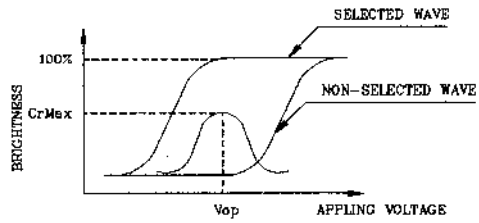

(negative type)

*Conditions

Viewing Angle : 0
 Frame Frequency : 70Hz
 Applying Waveform : 1/N duty 1/a bias

(NOTE 2)

Definition of Response Time(Tr,Tf)

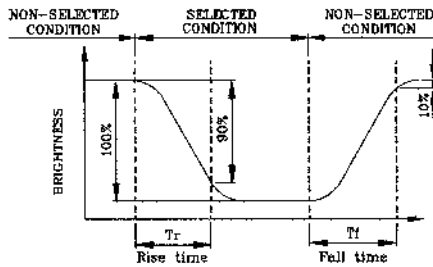

(positive type)

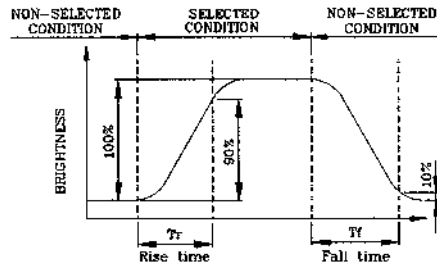

(negative type)

*Conditions

Operating Voltage : Vop
 Viewing Angle (θ) : (0,0)
 Frame Frequency : 70Hz
 Applying Waveform : 1/N duty 1/a bias

(NOTE 3)

Description of Measuring Equipment and Driving Waveforms

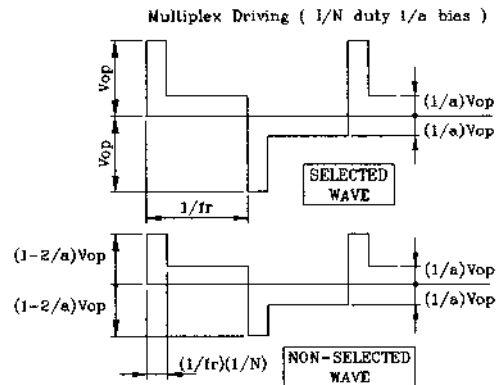
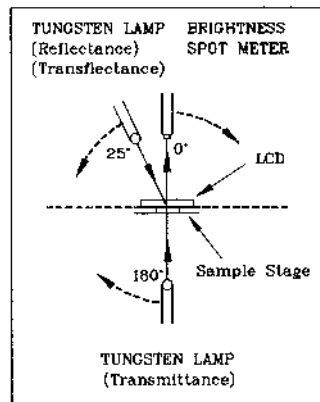

(NOTE 4)

Definition of Viewing Direction

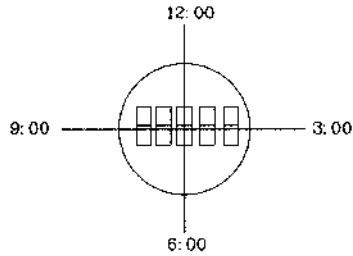

(NOTE 5)

Definition of Viewing Angle

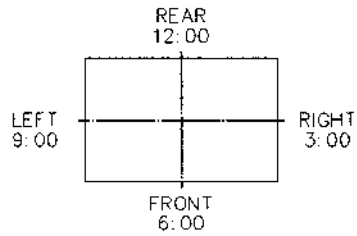
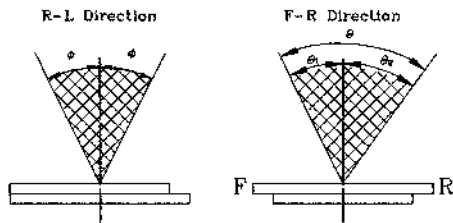

*For This Product
The Viewing Direction Is 6 O'clock
So $\theta_1 > \theta_2$

$$\theta = \theta_1 + \theta_2$$

*Conditions

Operating Voltage : V_{op}
Frame Frequency : 70Hz
Applying Waveform : 1/N duty 1/a bias
Contrast Ratio : larger than 2

(NOTE 6)

Definition of Contrast Ratio (Cr)

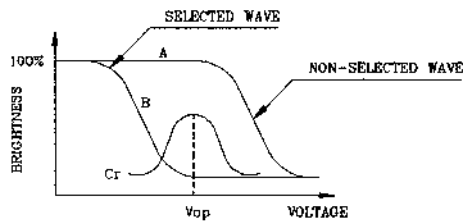

(positive type)

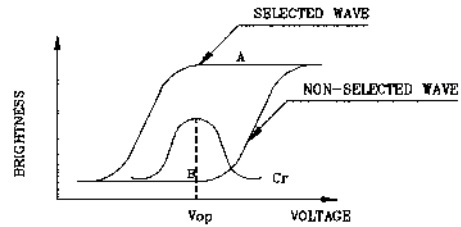

(negative type)

$$\text{Contrast Ratio : } Cr = A/B$$

*Conditions

Viewing Angle : 0
Frame Frequency : 70Hz
Applying Waveform : 1/N duty 1/a bias

HANTRONIX, INC.
10080 BUBB RD.
CUPERTINO, CA 95014

Q.A.:
JB

REV.:
1.0

HDM6448-1

SHEET 7 OF 15

DATE:
7/28/00

BLOCK DIAGRAM

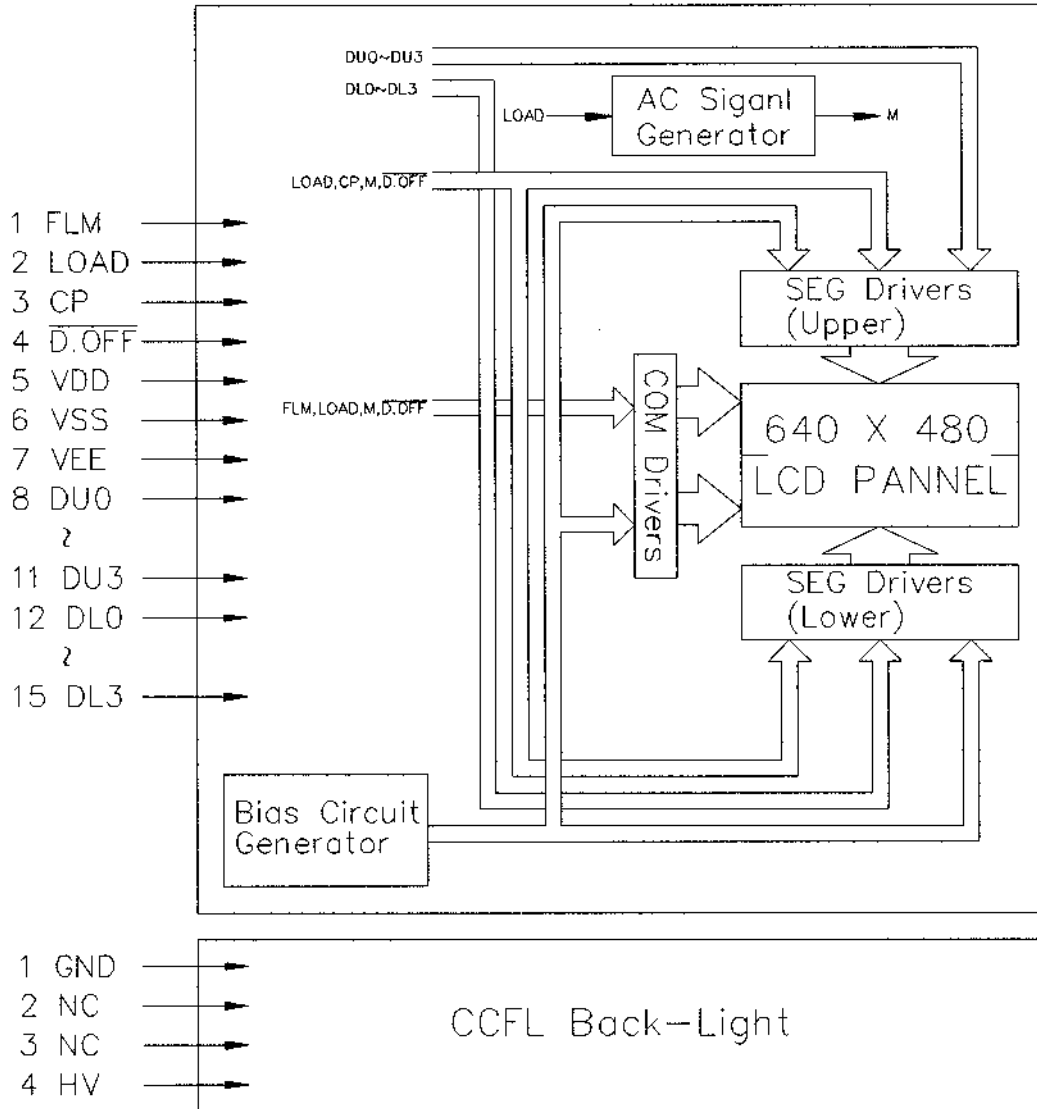

* AC Signal Setting

J1	J2	J3	J4	J5	J6	J7	J8
H	L	L	H	H	L	L	L

HANTRONIX, INC.
10080 BUBB RD.
CUPERTINO, CA 95014

Q.A.:
JB

REV.:
1.0

HDM6448-1

SHEET 8 OF 15

DATE:
7/28/00

INTERNAL PIN CONNECTION

LCD

Pin No.	Symbol	Level	Function
1	FLM	H/L	SCAN START-UP SIGNAL
2	LOAD	H-L	DATA LATCH PULSE
3	CP	H-L	DATA SHIFT PULSE
4	$\overline{D.OFF}$	H/L	DISPLAY OFF ("H"=ON,"L"=OFF)
5	VDD	-	POWER SUPPLY FOR LOGIC (+5V)
6	VSS	-	SIGNAL GROUND (GND)
7	VEE	-	POWER SUPPLY FOR LCD (-V)
8	DU0	H/L	DISPLAY DATA (UPPER HALF)
9	DU1		
10	DU2		
11	DU3		
12	DL0	H/L	DISPLAY DATA (LOWER HALF)
13	DL1		
14	DL2		
15	DL3		

CCFT

Pin No.	Symbol	Level	Function
1	GND	-	GROUND LINE (INVERTER)
2	NC	-	NON CONNECTION
3	NC	-	NON CONNECTION
4	HV	-	HIGH VOLTAGE LINE (INVERTER)

LCD

Used connector : 53261-1590 (MOLEX)

Mating connector : 51021-1500 (MOLEX)

CCFT

Used connector : M63M83-04 (MITSUMI)

Mating connector : M60-04-30-114P (MITSUMI)

M60-04-30-134P (MITSUMI)

M61M73-04 (MITSUMI)

HANTRONIX, INC. 10080 BUBB RD. CUPERTINO, CA 95014	Q.A.:	REV.:	HDM6448-1	SHEET 9 OF 15
	JB	1.0		DATE: 7/28/00

POWER SUPPLY

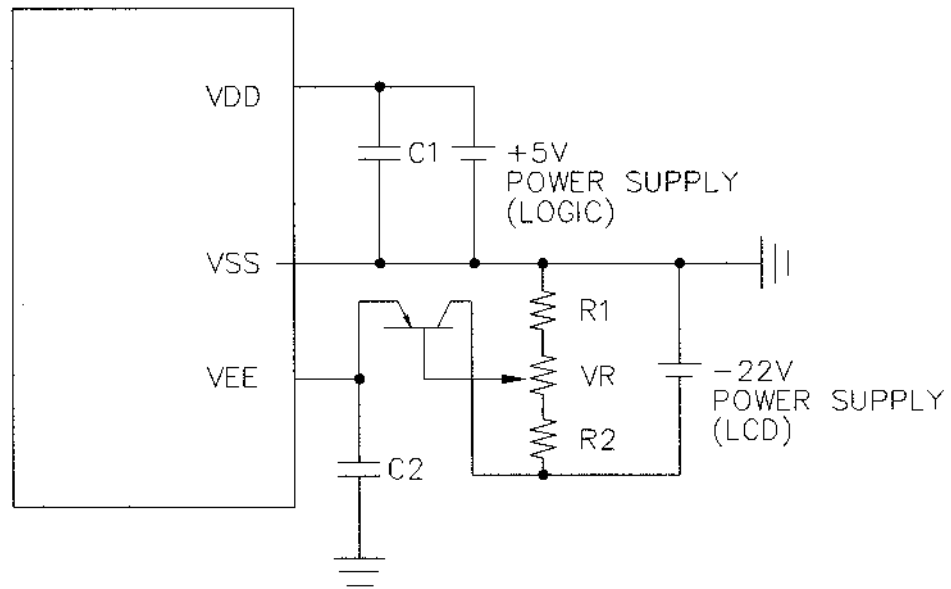

1. $R1 + VR + R2 = 10K \sim 20K \Omega$

2. $C1, C2 : 10 \mu F$

HANTRONIX, INC.
10080 BUBB RD.
CUPERTINO, CA 95014

Q.A.:
JB

REV.:
1.0

HDM6448-1

SHEET 10 OF 15

DATE:
7/28/00

TIMING CHARACTERISTICS

@VDD=2.5~5.5V

ITEM	SYMBOL	MIN.	TYP.	MAX.	UNIT
Shift Clock Period	t_{cp}	152	-	-	ns
"CP" PULSE WIDTH	t_w	65	-	-	ns
CLOCK RISE, FALL TIME	t_r, t_f	-	-	50	ns
DATA SETUP TIME	t_{osu}	50	-	-	ns
DATA HOLD TIME	t_{dhd}	40	-	-	ns
"CP" → "LOAD" FALL TIME	t_{lsu}	65	-	-	ns
"LOAD" → "CP" FALL TIME	t_{lc}	65	-	-	ns
"FLM" SETUP TIME	t_{setup}	100	-	-	ns
"FLM" HOLD TIME	t_{hold}	100	-	-	ns
"LOAD" PULSE WIDTH	t_{wc}	65	-	-	ns

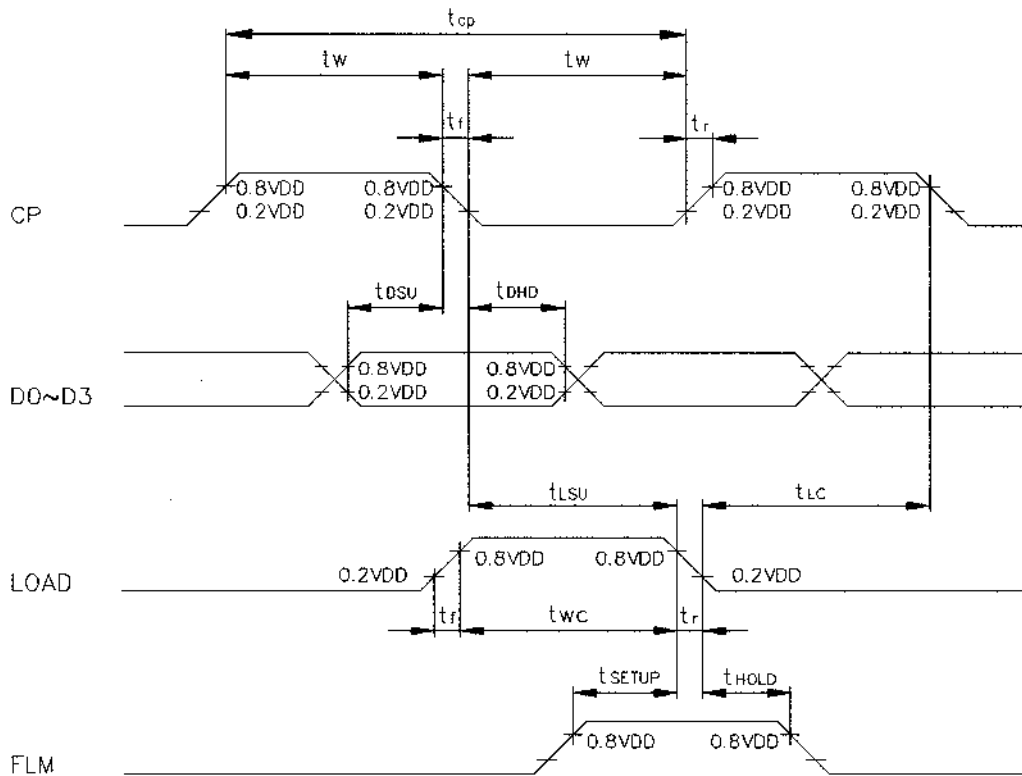

HANTRONIX, INC.
10080 BUBB RD.
CUPERTINO, CA 95014

Q.A.:
JB

REV.:
1.0

HDM6448-1

SHEET 11 OF 15

DATE:
7/28/00

TIMING TIMING

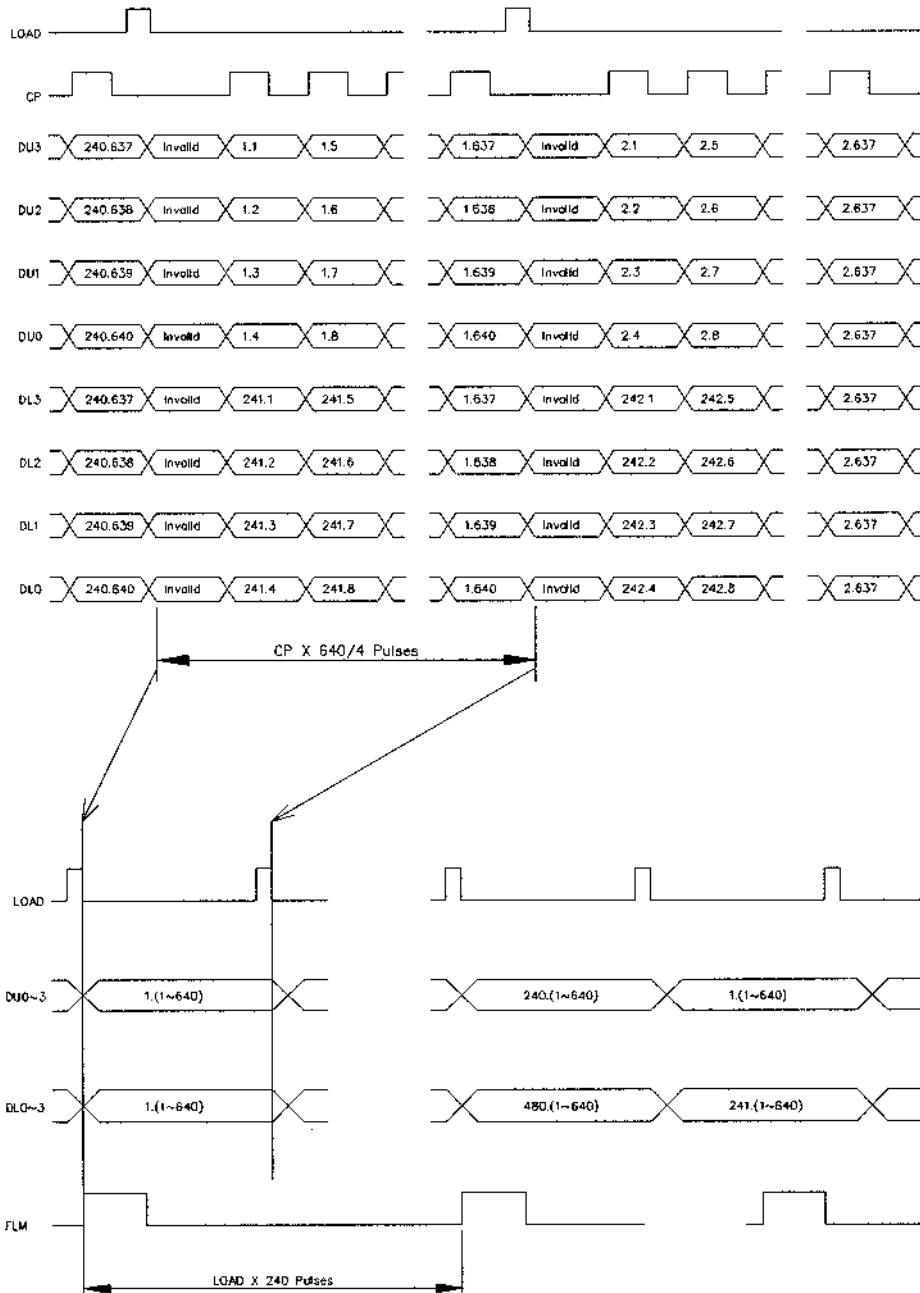

HANTRONIX, INC.
 10080 BUBB RD.
 CUPERTINO, CA 95014

Q.A.:
 JB

REV.:
 1.0

HDM6448-1

SHEET 12 OF 15

DATE:
 7/28/00

POWER ON/OFF TIMING

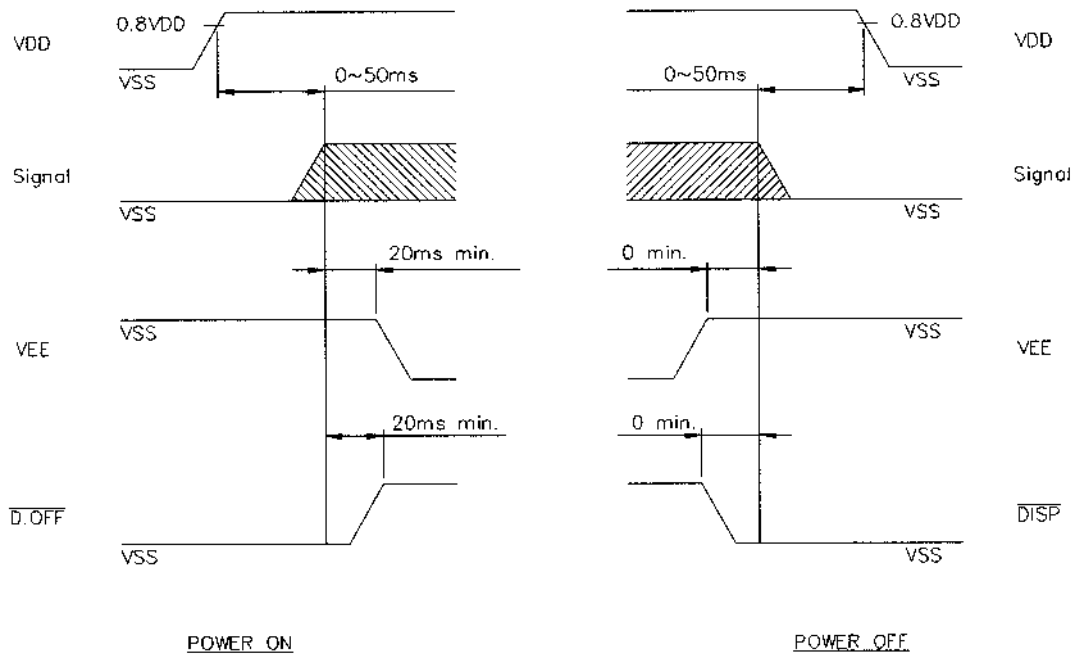

The missing pixels may occur when the LCM is driven beyond above power interface timing sequence.

HANTRONIX, INC. 10080 BUBB RD. CUPERTINO, CA 95014	Q.A.:	REV.:	HDM6448-1	SHEET 13 OF 15
	JB	1.0		DATE: 7/28/00

DISPLAY PATTERN

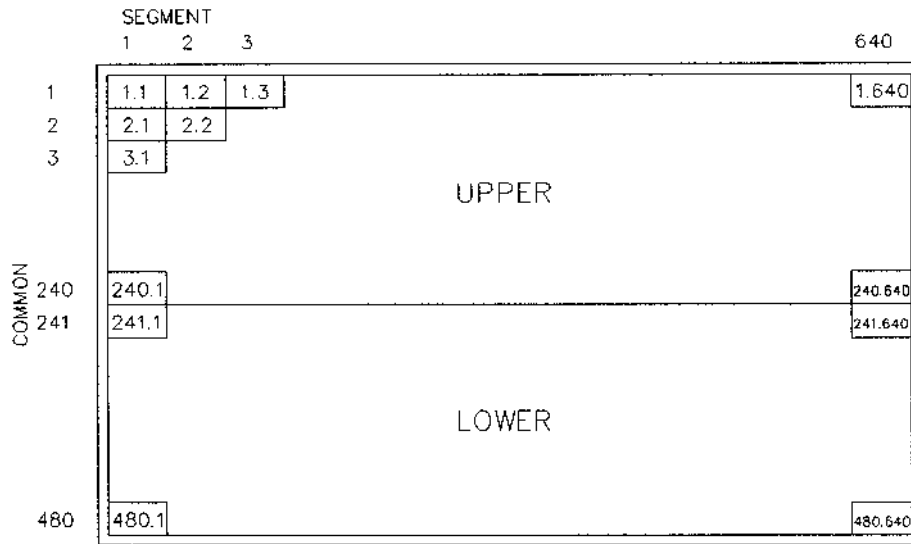

NOTE : 1.1 MEANS 1ST COMMON 1ST SEGMENT DOT

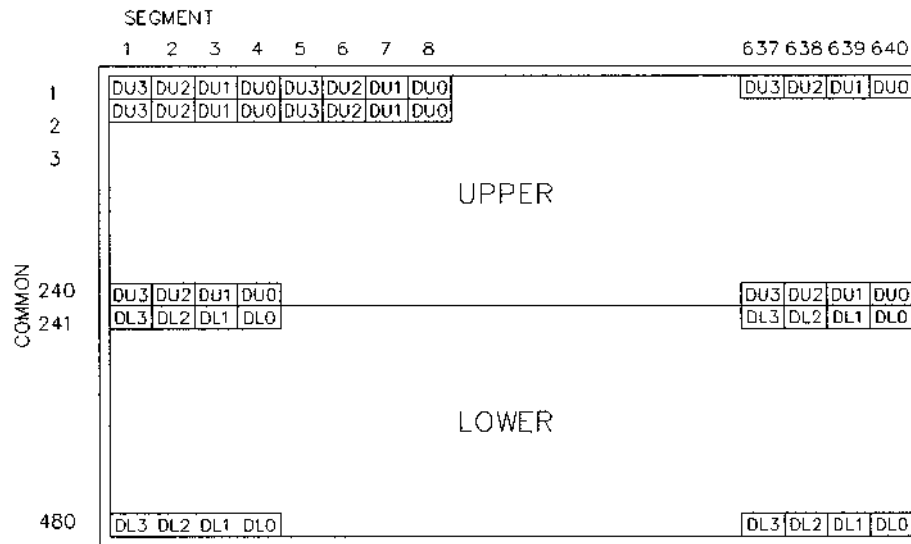

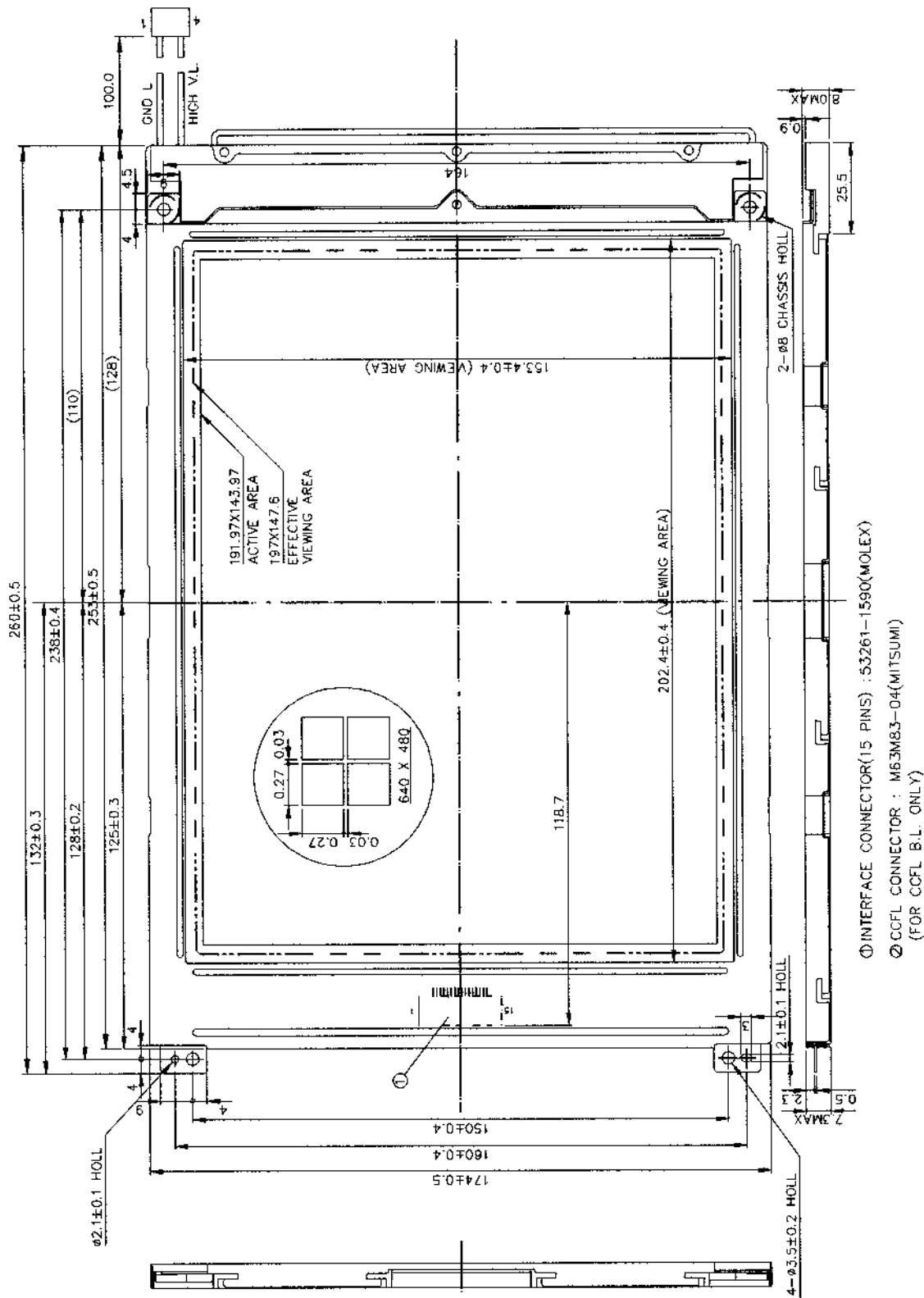

HANTRONIX, INC.
10080 BUBB RD.
CUPERTINO, CA 95014

Q.A.:
JB

REV.:
1.0

HDM6448-1

SHEET 15 OF 15

DATE:
7/28/00