

HER101 THRU HER108

HIGH EFFICIENCY RECTIFIERS

Reverse Voltage – 50 to 1000 Volts

Forward Current – 1.0 Ampere

DO-41

Features

- Plastic package has Underwriters Laboratory Flammability Classification 94V-O utilizing Flame Retardant Epoxy Molding Compound
- Void-free Plastic in DO-41 package
- 1.0 amperes operation at $T_a = 55^\circ\text{C}$ with no thermal runaway
- Ultra Fast switching for high efficiency
- Exceeds environmental standards of MIL-S-19500/228

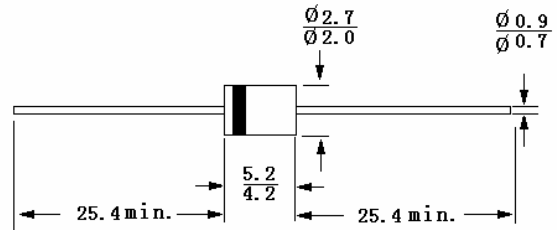

Dimensions in mm

Mechanical Data

- **Case:** Molded plastic, DO-41
- **Lead:** MIL-STD-202 method 208 guaranteed
- **Polarity:** Band denotes cathode
- **Mounting Position:** Any

Absolute Maximum Ratings and Characteristics

Ratings at 25°C ambient temperature unless otherwise specified. Single phase, half wave, 60Hz, resistive or inductive load.

	Symbols	HER 101	HER 102	HER 103	HER 104	HER 105	HER 106	HER 107	HER 108	Units
Maximum repetitive peak reverse voltage	V_{RRM}	50	100	200	300	400	600	800	1000	Volts
Maximum RMS voltage	V_{RMS}	35	70	140	210	280	420	560	700	Volts
Maximum DC blocking voltage	V_{DC}	50	100	200	300	400	600	800	1000	Volts
Maximum average forward rectified current at $T_A = 55^\circ\text{C}$	I_O	1.0								Amp
Peak forward surge current 8.3ms single half sine-wave superimposed on rated load (JEDEC method)	I_{FSM}	30								Amps
Maximum instantaneous forward voltage at 1A DC	V_F	1.0		1.3		1.7				Volts
Maximum reverse current at rated reverse voltage	I_R			10		500				μAmps
Maximum reverse recovery time (Note 1)	t_{rr}	50			75					nSec
Typical junction capacitance (Note 2)	C_J	17								pF
Typical junction resistance (Note 3)	$R_{\theta JA}$	60								$^\circ\text{C/W}$
Operating and storage temperature range	T_J, T_S	-55 to +150								$^\circ\text{C}$

Notes:

1. Test Conditions: $I_F = 0.5\text{A}$, $I_R = -1\text{A}$, $I_{RR} = -0.25\text{A}$.
2. Measured at 1MHz and applied reverse voltage of 4 volts DC.
3. Thermal resistance from junction to ambient and from junction to lead length 0.375"(9.5mm) P.C.B. mounted.

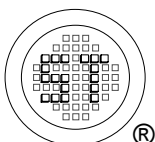

SEMTECH ELECTRONICS LTD.

(Subsidiary of Sino-Tech International Holdings Limited, a company listed on the Hong Kong Stock Exchange, Stock Code: 724)



ISO/TS 16949 : 2002
Certificate No. 05103



ISO 14001:2004
Certificate No. 7116



ISO 9001:2000
Certificate No. 0506098

Dated : 22/03/2003

HER101 THRU HER108

REVERSE RECOVERY TIME CHARACTERISTIC AND TEST CIRCUIT DIAGRAM

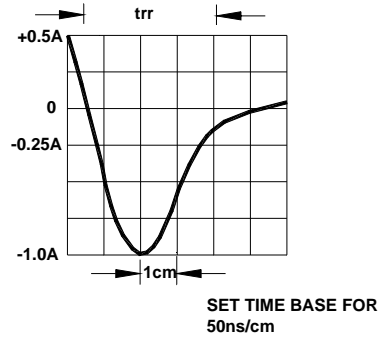
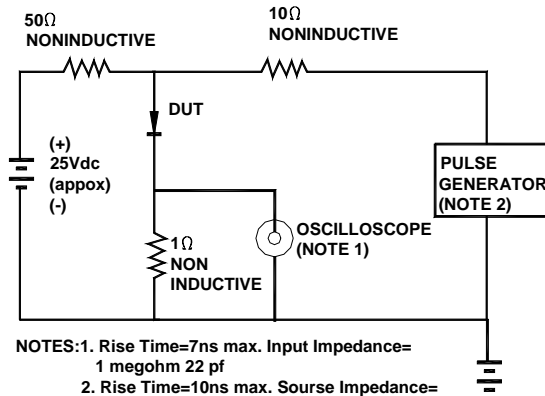

FORWARD CHARACTERISTICS

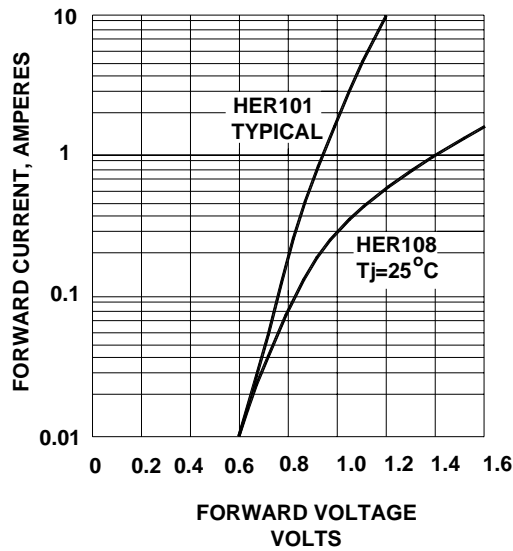

FORWARD CURRENT DERATING CURVE

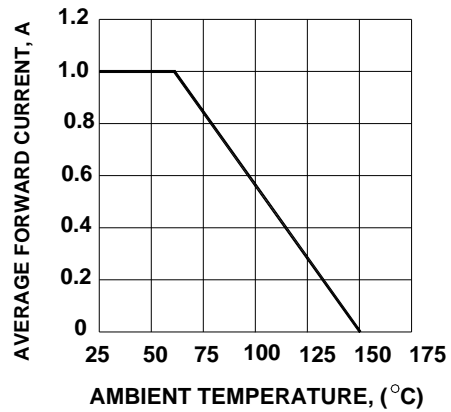

TYPICAL JUNCTION CAPACITANCE

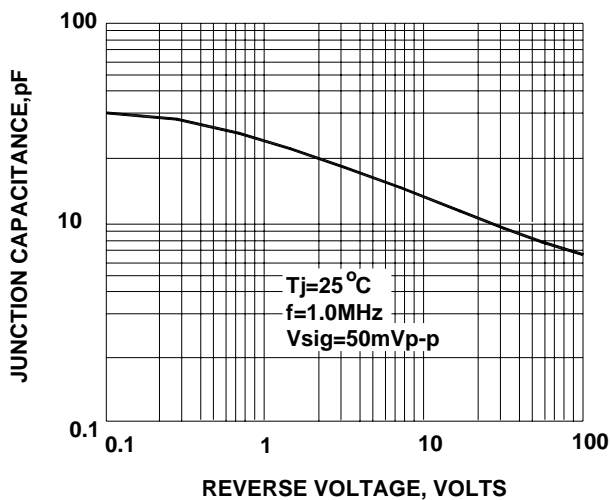

PEAK FORWARD SURGE CURRENT

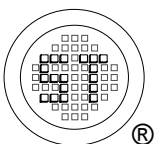
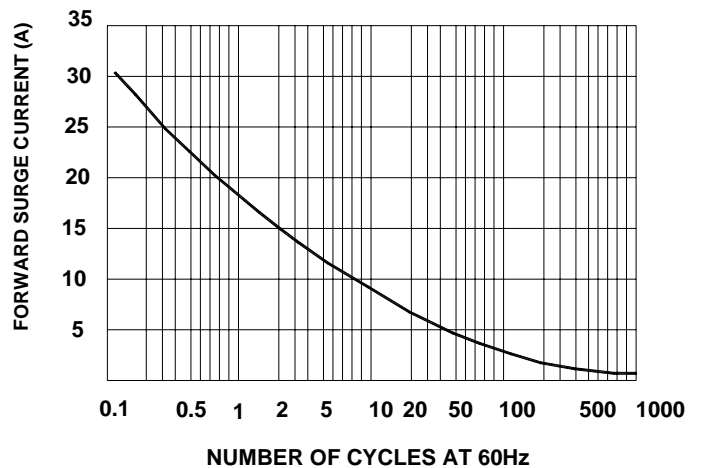

SEMTECH ELECTRONICS LTD.

(Subsidiary of Sino-Tech International Holdings Limited, a company listed on the Hong Kong Stock Exchange, Stock Code: 724)



ISO/TS 16949 : 2002
Certificate No. 05103



ISO 14001:2004
Certificate No. 7116



ISO 9001:2000
Certificate No. 0506098

Dated : 22/03/2003