

High Efficient Rectifiers

FEATURES

- High efficiency, Low VF
- High current capability
- High reliability
- High surge current capability
- Low power loss
- Compliant to RoHS Directive 2011/65/EU and in accordance to WEEE 2002/96/EC
- Halogen-free according to IEC 61249-2-21 definition

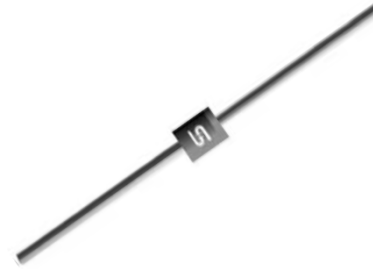

DO-204AL (DO-41)

MECHANICAL DATA

Case: DO-204AL (DO-41)

Molding compound, UL flammability classification rating 94V-0

Base P/N with suffix "G" on packing code - green compound (halogen-free)

Terminal: Matte tin plated leads, solderable per JESD22-B102

Meet JESD 201 class 1A whisker test

Weight: 0.3 g (approximately)

MAXIMUM RATINGS AND ELECTRICAL CHARACTERISTICS (T _A =25°C unless otherwise noted)											
PARAMETER	SYMBOL	HER 101	HER 102	HER 103	HER 104	HER 105	HER 106	HER 107	HER 108	UNIT	
Maximum repetitive peak reverse voltage	V _{RRM}	50	100	200	300	400	600	800	1000	V	
Maximum RMS voltage	V _{RMS}	35	70	140	210	280	420	560	700	V	
Maximum DC blocking voltage	V _{DC}	50	100	200	300	400	600	800	1000	V	
Maximum average forward rectified current	I _{F(AV)}	1.0								A	
Peak forward surge current, 8.3 ms single half sine-wave superimposed on rated load	I _{FSM}	30								A	
Maximum instantaneous forward voltage (Note 1) @ 1 A	V _F	1.0			1.3		1.7			V	
Maximum reverse current @ rated VR T _J =25 °C T _J =125 °C	I _R	5 150								μA	
Maximum reverse recovery time (Note 2)	T _{rr}	50					75				ns
Typical junction capacitance (Note 3)	C _j	25					20				pF
Typical thermal resistance	R _{θJC} R _{θJL} R _{θJA}	15 25 70								°C/W	
Operating junction temperature range	T _J	- 55 to +150								°C	
Storage temperature range	T _{STG}	- 55 to +150								°C	

Note1: Pulse Test with PW=300μs, 1% Duty Cycle

Note2: Reverse Recovery Test Conditions: I_F=0.5A, I_R=1.0A, I_{RR}=0.25A

Note3: Measured at 1 MHz and Applied Reverse Voltage of 4.0V D.C.

ORDERING INFORMATION				
PART NO.	PACKING CODE	GREEN COMPOUND CODE	PACKAGE	PACKING
HER10x (Note 1)	A0	Suffix "G"	DO-41	3,000 / Ammo box (52mm taping)
	R0		DO-41	5,000 / 13" Paper reel
	R1		DO-41	5,000 / 13" Paper reel (Reverse)
	B0		DO-41	1,000 / Bulk packing

Note 1: "x" defines voltage from 50V (HER101) to 1000V (HER108)

EXAMPLE				
PREFERRED P/N	PART NO.	PACKING CODE	GREEN COMPOUND CODE	DESCRIPTION
HER107 A0	HER107	A0		
HER107 A0G	HER107	A0	G	Green compound

RATINGS AND CHARACTERISTICS CURVES

(TA=25°C unless otherwise noted)

FIG. 1 FORWARD CURRENT DERATING CURVE

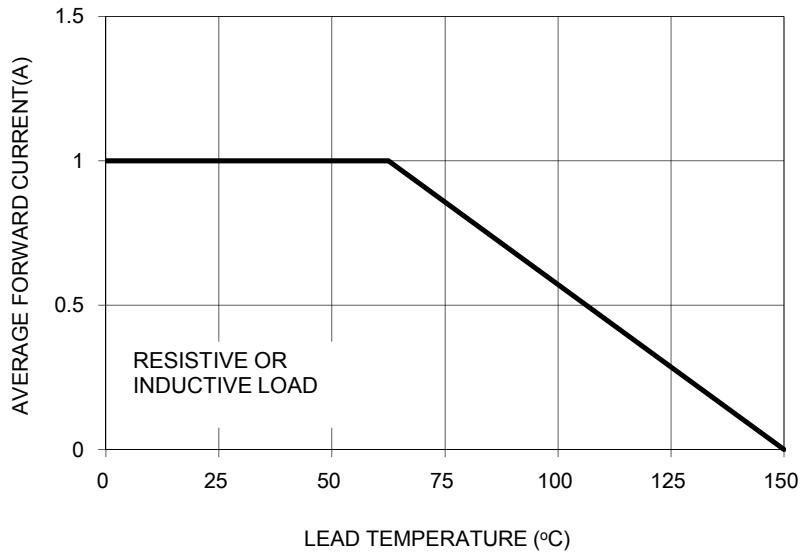

FIG. 2 TYPICAL REVERSE CHARACTERISTICS

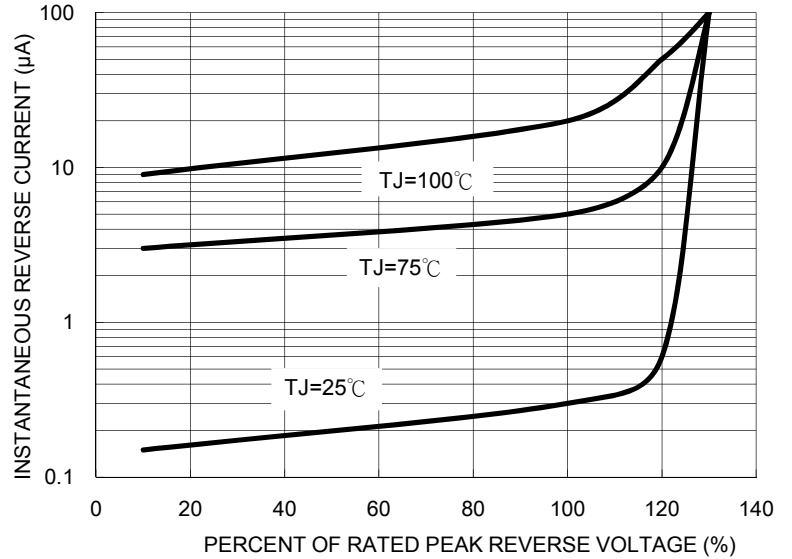

FIG. 3 MAXIMUM NON-REPETITIVE FORWARD SURGE CURRENT

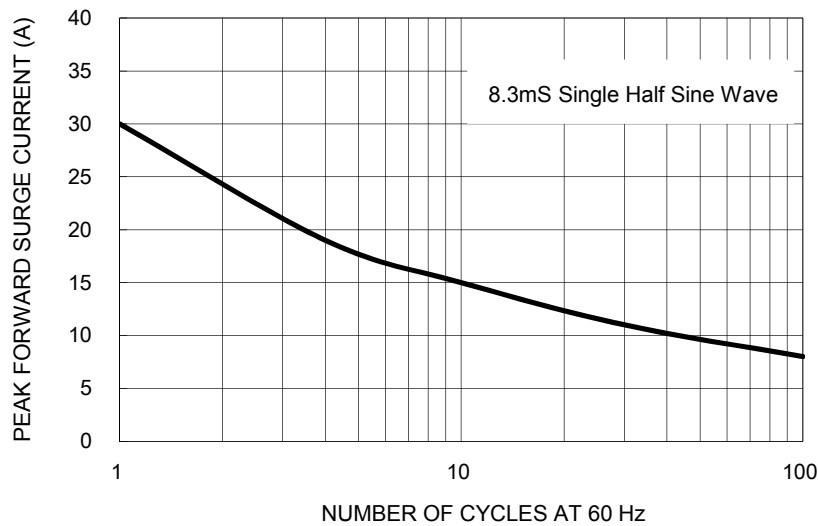

FIG. 4 TYPICAL FORWARD CHARACTERISTICS

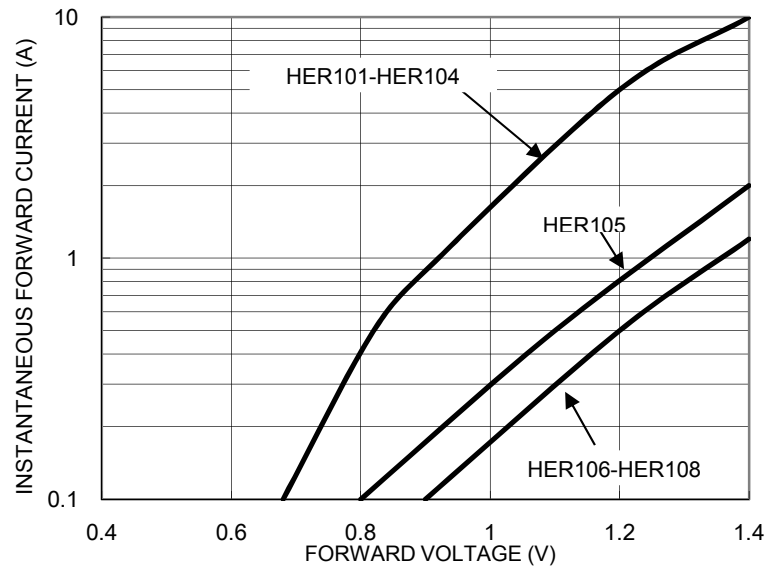

FIG. 5 TYPICAL JUNCTION CAPACITANCE

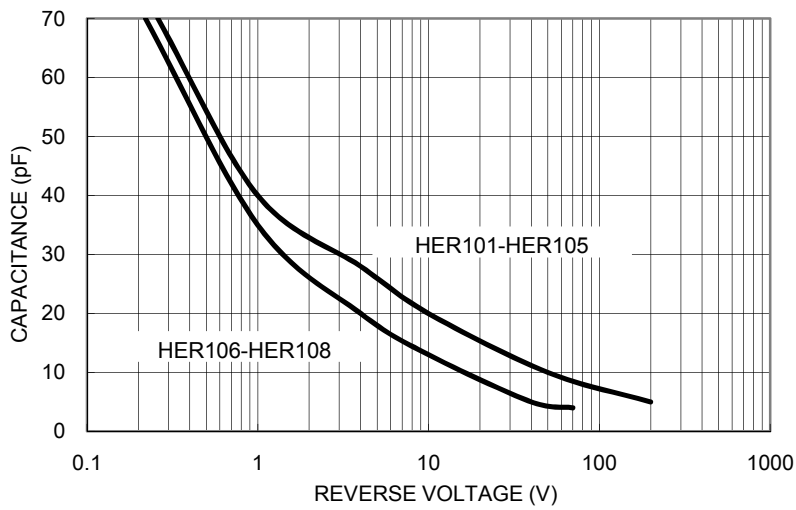
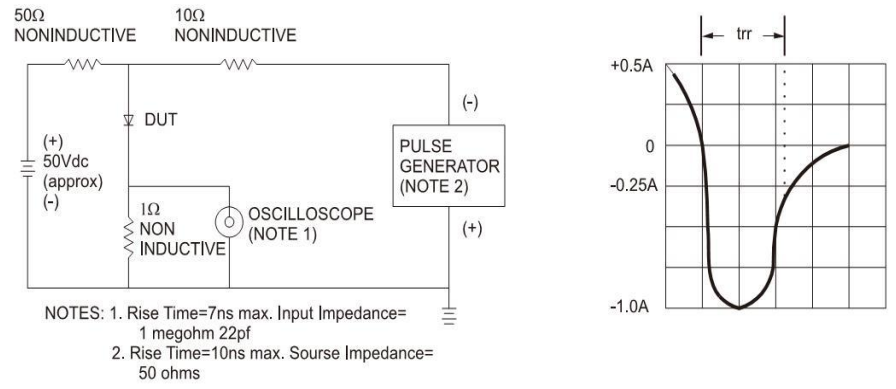
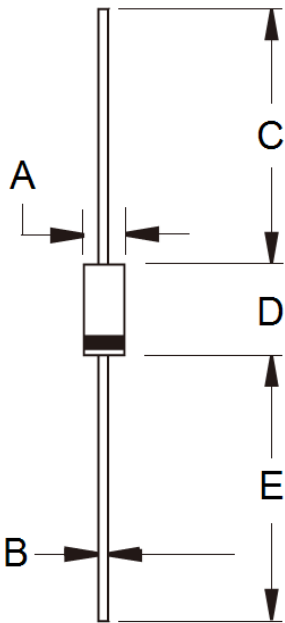

FIG.6- REVERSE RECOVERY TIME CHARACTERISTIC AND TEST CIRCUIT DIAGRAM



PACKAGE OUTLINE DIMENSIONS



DIM.	Unit (mm)		Unit (inch)	
	Min	Max	Min	Max
A	2.00	2.70	0.079	0.106
B	0.71	0.86	0.028	0.034
C	25.40	-	1.000	-
D	4.20	5.20	0.165	0.205
E	25.40	-	1.000	-

MARKING DIAGRAM



P/N = Specific Device Code
G = Green Compound
YWW = Date Code
F = Factory Code

Notice

Specifications of the products displayed herein are subject to change without notice. TSC or anyone on its behalf, assumes no responsibility or liability for any errors inaccuracies.

Information contained herein is intended to provide a product description only. No license, express or implied, to any intellectual property rights is granted by this document. Except as provided in TSC's terms and conditions of sale for such products, TSC assumes no liability whatsoever, and disclaims any express or implied warranty, relating to sale and/or use of TSC products including liability or warranties relating to fitness for a particular purpose, merchantability, or infringement of any patent, copyright, or other intellectual property right.

The products shown herein are not designed for use in medical, life-saving, or life-sustaining applications. Customers using or selling these products for use in such applications do so at their own risk and agree to fully indemnify TSC for any damages resulting from such improper use or sale.