

HER801 THRU HER806

8.0 AMP HIGH EFFICIENCY RECTIFIERS

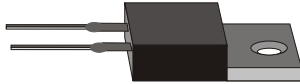

FEATURES

- * Low forward voltage drop
- * High current capability
- * High reliability
- * High surge current capability
- * High speed switching

MECHANICAL DATA

- * Case: Molded plastic
- * Epoxy: UL 94V-0 rate flame retardant
- * Lead: Lead solderable per MIL-STD-202, method 208 guaranteed
- * Polarity: As Marked
- * Mounting position: Any
- * Weight: 2.24 grams

VOLTAGE RANGE

50 to 600 Volts

CURRENT

8.0 Ampere

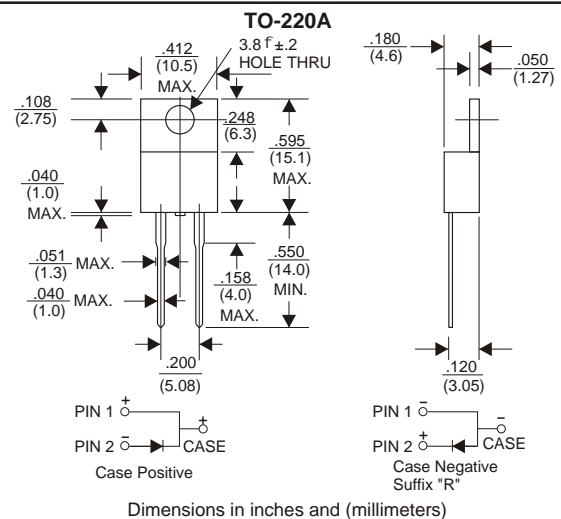

MAXIMUM RATINGS AND ELECTRICAL CHARACTERISTICS

Rating 25°C ambient temperature unless otherwise specified.
Single phase half wave, 60Hz, resistive or inductive load.
For capacitive load, derate current by 20%.

TYPE NUMBER	HER801	HER802	HER803	HER804	HER805	HER806	UNITS
Maximum Recurrent Peak Reverse Voltage	50	100	200	300	400	600	V
Maximum RMS Voltage	35	70	140	210	280	420	V
Maximum DC Blocking Voltage	50	100	200	300	400	600	V
Maximum Average Forward Rectified Current .375" (9.5mm) Lead Length at T _c =75°C	8.0						A
Peak Forward Surge Current, 8.3 ms single half sine-wave superimposed on rated load (JEDEC method)	150						A
Maximum Instantaneous Forward Voltage at 8.0A	1.0		1.3		1.85		V
Maximum DC Reverse Current T _c =25°C	10.0						mA
at Rated DC Blocking Voltage T _c =100°C	200						mA
Maximum Reverse Recovery Time (Note 1)	60					100	nS
Typical Junction Capacitance (Note 2)	65						pF
Operating and Storage Temperature Range T _j , T _{stg}	-55 — +150						°C

NOTES:

- Reverse Recovery Time test condition: I_F=0.5A, I_R=1.0A, I_{RR}=0.25A
- Measured at 1MHz and applied reverse voltage of 4.0V D.C.

RATING AND CHARACTERISTIC CURVES (HER801 THRU HER807)

FIG.1-TYPICAL FORWARD CHARACTERISTICS

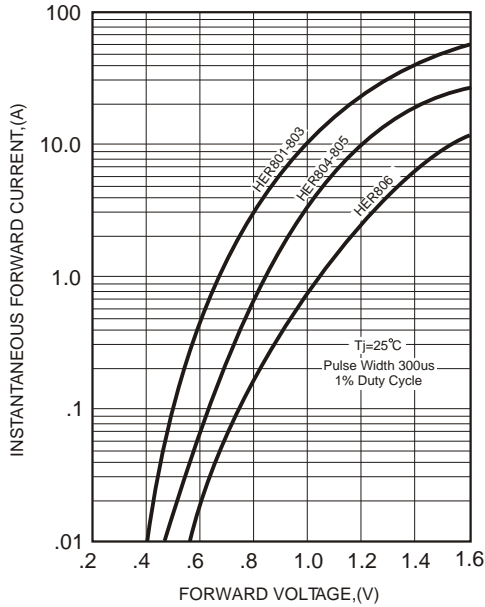

FIG.2-TYPICAL FORWARD CURRENT DERATING CURVE

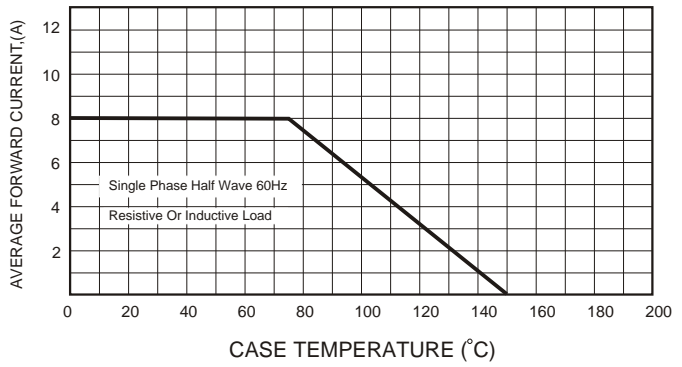

FIG.4-MAXIMUM NON-REPETITIVE FORWARD SURGE CURRENT

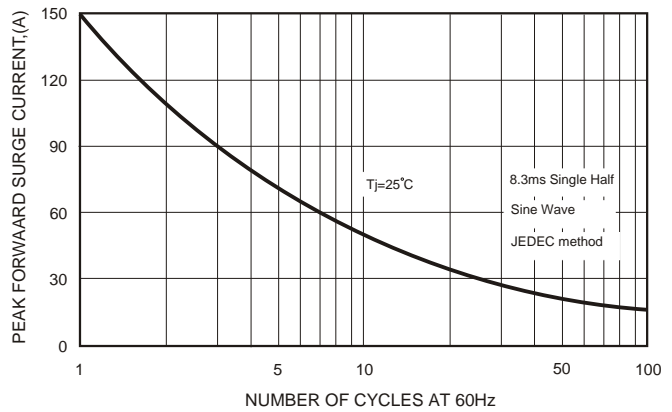
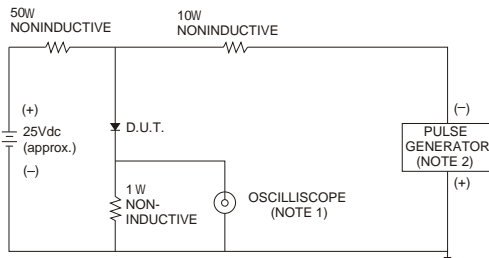

FIG.3- TEST CIRCUIT DIAGRAM AND REVERSE RECOVERY TIME CHARACTERISTICS



- NOTES: 1. Rise Time= 7ns max., Input Impedance= 1 megohm, 22pF.
2. Rise Time= 10ns max., Source Impedance= 50 ohms.

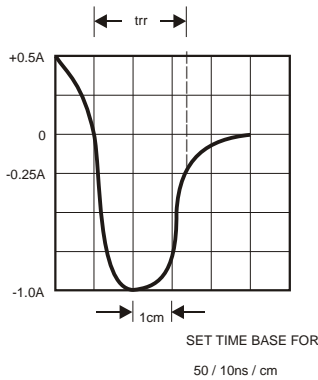

FIG.5-TYPICAL JUNCTION CAPACITANCE

