

REPLACEMENT TYPE : PXT8050

FEATURES

- Compliment to HEXT8550

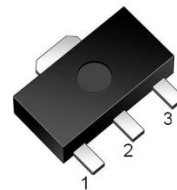

SOT-89 MARKING:Y1

1:BASE 2:COLLECTOR 3:EMITTER

MAXIMUM RATINGS ($T_A = 25^\circ\text{C}$ unless otherwise noted)

Parameter	Symbol	Value	Unit
Collector-Base Voltage	V_{CB0}	40	V
Collector-Emitter Voltage	V_{CEO}	25	V
Emitter-Base Voltage	V_{EBO}	5	V
Collector Current-Continuous	I_C	1.5	A
Collector Power Dissipation	P_C	0.5	W
Thermal Resistance From Junction to Ambient	$R_{\theta JA}$	250	$^\circ\text{C/W}$
Junction Temperature	T_J	150	$^\circ\text{C}$
Storage Temperature	T_{stg}	-55~150	$^\circ\text{C}$

ELECTRICAL CHARACTERISTICS ($T_A=25^\circ\text{C}$ unless otherwise noted)

Parameter	Symbol	Test conditions	Min	Typ	Max	Unit
Collector-Base Breakdown Voltage	V_{CB0}	$I_C=100\mu\text{A}$, $I_E=0$	40			V
Collector-Emitter Breakdown Voltage	V_{CEO}	$I_C=0.1\text{mA}$, $I_B=0$	25			V
Emitter-Base Breakdown Voltage	V_{EBO}	$I_E=100\mu\text{A}$, $I_C=0$	5			V
Collector Cut-off Current	I_{CBO}	$V_{CB}=40\text{V}$, $I_E=0$			0.1	μA
Collector Cut-off Current	I_{CEO}	$V_{CB}=20\text{V}$, $I_E=0$			0.1	μA
Emitter Cut-off Current	I_{EBO}	$V_{EB}=5\text{V}$, $I_C=0$			0.1	μA
DC Current Gain	$h_{FE(1)}$	$V_{CE}=1\text{V}$, $I_C=100\text{mA}$	85		400	
	$h_{FE(2)}$	$V_{CE}=1\text{V}$, $I_C=800\text{mA}$	40			
Collector-Emitter Saturation Voltage	$V_{CE(sat)}$	$I_C=800\text{mA}$, $I_B=80\text{mA}$			0.5	V
Base-Emitter Saturation Voltage	$V_{BE(sat)}$	$I_C=800\text{mA}$, $I_B=80\text{mA}$			1.2	V
Base-Emitter Voltage	V_{BE}	$V_{CE}=1\text{V}$, $I_C=10\text{mA}$			1	V
Base-Emitter Positive Favor Voltage	V_{BEF}	$I_B=1\text{A}$			1.55	V
Output Capacitance	C_{ob}	$V_{CB}=10\text{V}$, $I_E=0$, $f=1\text{MHz}$			15	PF
Transition Frequency	f_T	$V_{CE}=10\text{V}$, $I_C=50\text{mA}$ $f=30\text{MHz}$	100			MHz

CLASSIFICATION OF h_{FE}

Rank	B	C	D	D3
Range	85-160	120-200	160-300	300-400

Typical Characteristics

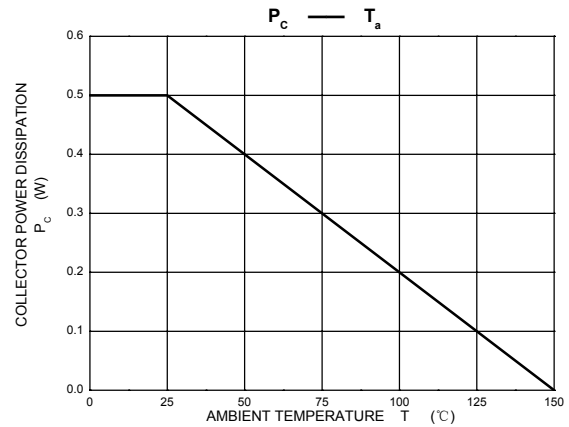
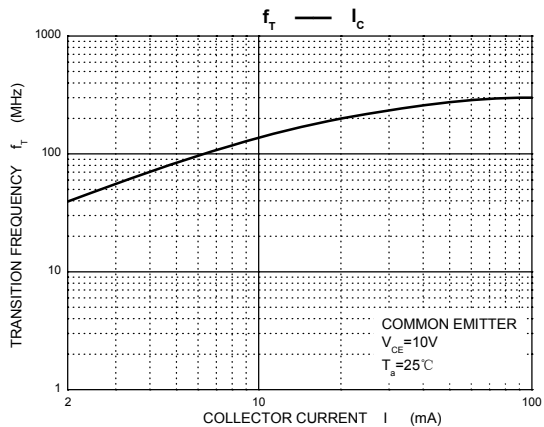
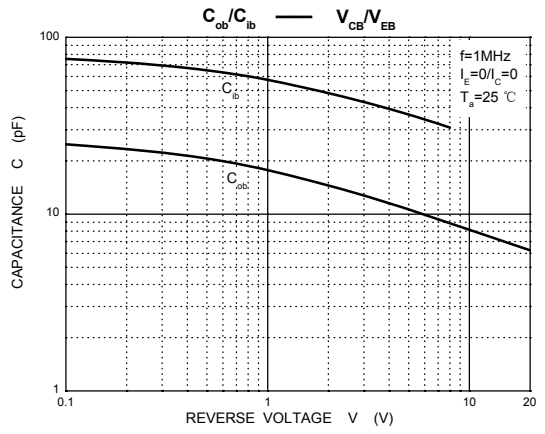
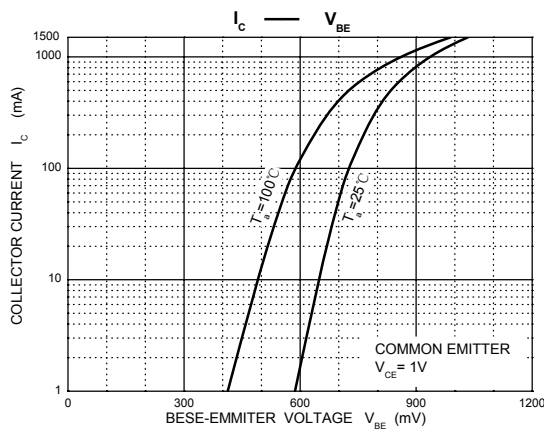
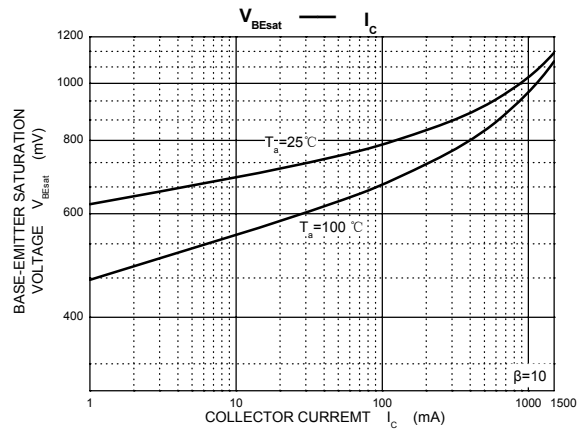
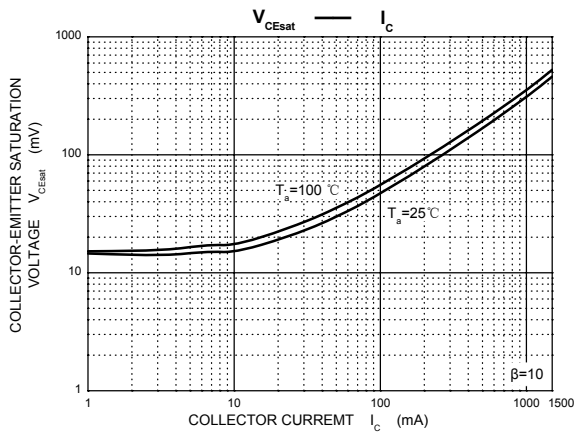
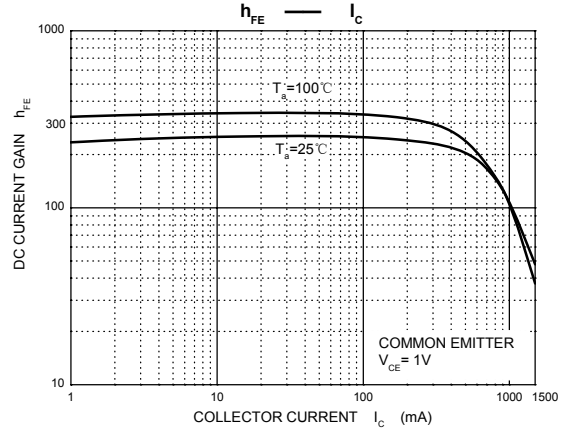
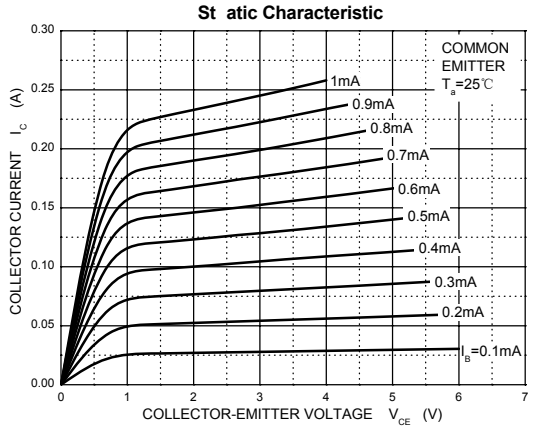

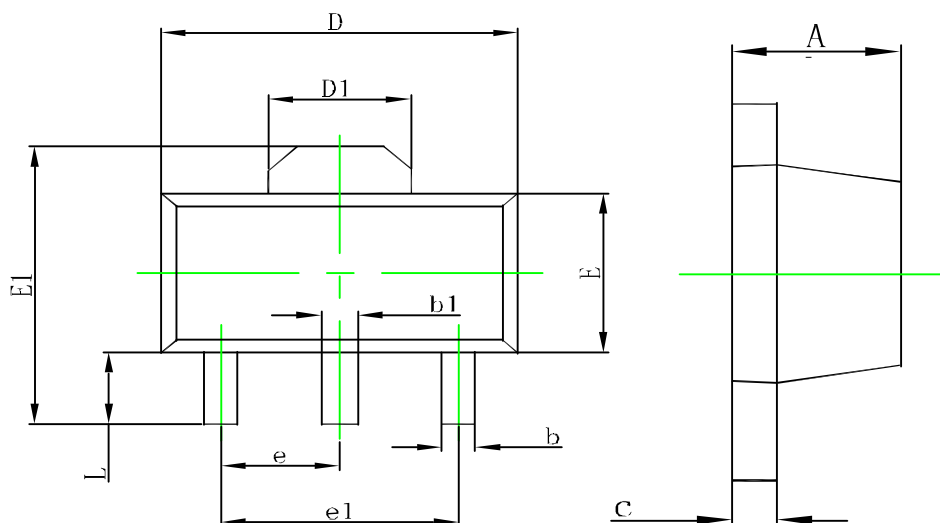
SOT-89 Package Outline Dimensions

Symbol	Dimensions In Millimeters		Dimensions In Inches	
	Min.	Max.	Min.	Max.
A	1.400	1.600	0.055	0.063
b	0.320	0.520	0.013	0.020
b1	0.400	0.580	0.016	0.023
c	0.350	0.440	0.014	0.017
D	4.400	4.600	0.173	0.181
D1	1.550REF.		0.061REF.	
E	2.300	2.600	0.091	0.102
E1	3.940	4.250	0.155	0.167
e	1.500TYP.		0.060TYP.	
e1	3.000TYP.		0.118TYP.	
L	0.900	1.200	0.035	0.047

SOT-89 Tape and Reel

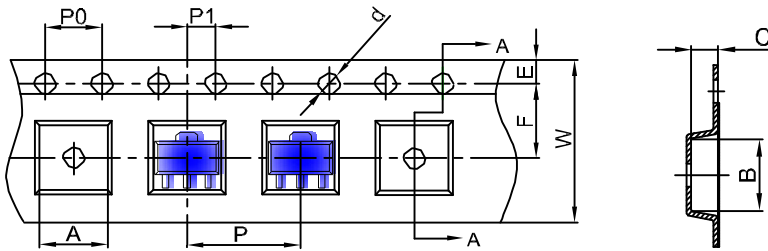

DIMENSIONS ARE IN MILLIMETER										
TYPE	A	B	C	d	E	F	P0	P	P1	W
SOT-89	4.85	4.45	1.85	φ1.50	1.75	5.50	4.00	8.00	2.00	12.00
TOLERANCE	±0.1	±0.1	±0.1	±0.1	±0.1	±0.1	±0.1	±0.1	±0.1	±0.1

SOT-89 Tape Leader and Trailer

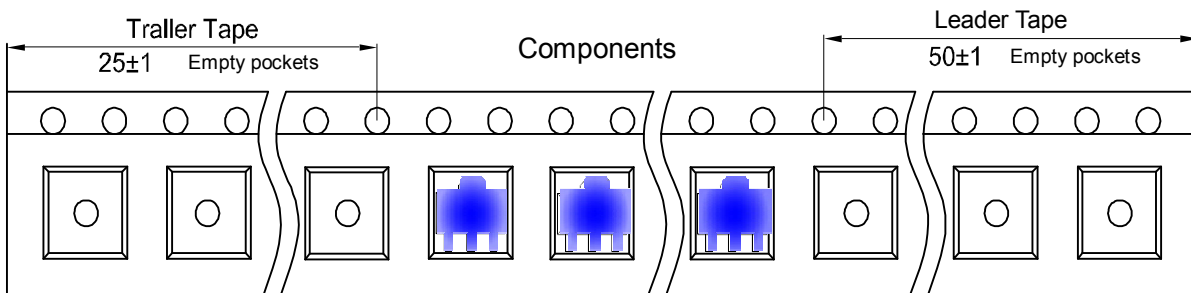

SOT-89 Reel

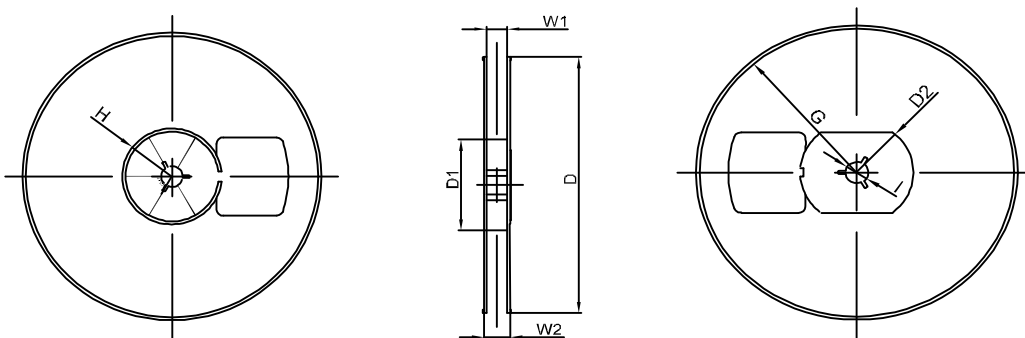

DIMENSIONS ARE IN MILLIMETER								
REEL OPTION	D	D1	D2	G	H	I	W1	W2
7" DIA	φ 180	60.00	R32.00	R86.50	R30.00	φ 13.00	13.20	16.50
TOLERANCE	±2	±1	±1	±1	±1	±1	±1	±1