

# HFH11N90

## 900V N-Channel MOSFET

$BV_{DSS} = 900\text{ V}$   
 $R_{DS(on) \text{ typ}} = 0.93\ \Omega$   
 $I_D = 11\text{ A}$

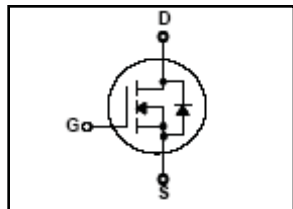
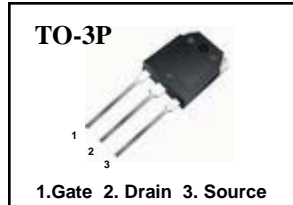

### FEATURES

- Originative New Design
- Superior Avalanche Rugged Technology
- Robust Gate Oxide Technology
- Very Low Intrinsic Capacitances
- Excellent Switching Characteristics
- Unrivalled Gate Charge : 75 nC (Typ.)
- Extended Safe Operating Area
- Lower  $R_{DS(ON)}$  : 0.93  $\Omega$  (Typ.) @  $V_{GS}=10V$
- 100% Avalanche Tested

### Absolute Maximum Ratings $T_C=25^\circ\text{C}$ unless otherwise specified

Symbol	Parameter	Value	Units
$V_{DSS}$	Drain-Source Voltage	900	V
$I_D$	Drain Current – Continuous ( $T_C = 25^\circ\text{C}$ )	11.0	A
	Drain Current – Continuous ( $T_C = 100^\circ\text{C}$ )	6.9	A
$I_{DM}$	Drain Current – Pulsed (Note 1)	44.0	A
$V_{GS}$	Gate-Source Voltage	$\pm 30$	V
$E_{AS}$	Single Pulsed Avalanche Energy (Note 2)	960	mJ
$I_{AR}$	Avalanche Current (Note 1)	11.0	A
$E_{AR}$	Repetitive Avalanche Energy (Note 1)	30	mJ
dv/dt	Peak Diode Recovery dv/dt (Note 3)	4.0	V/ns
$P_D$	Power Dissipation ( $T_C = 25^\circ\text{C}$ ) – Derate above $25^\circ\text{C}$	300	W
		2.38	W/ $^\circ\text{C}$
$T_J, T_{STG}$	Operating and Storage Temperature Range	-55 to +150	$^\circ\text{C}$
$T_L$	Maximum lead temperature for soldering purposes, 1/8" from case for 5 seconds	300	$^\circ\text{C}$

### Thermal Resistance Characteristics

Symbol	Parameter	Typ.	Max.	Units
$R_{\theta JC}$	Junction-to-Case	--	0.42	$^\circ\text{C/W}$
$R_{\theta CS}$	Case-to-Sink	0.24	--	
$R_{\theta JA}$	Junction-to-Ambient	--	40	

**Electrical Characteristics**  $T_C=25\text{ }^\circ\text{C}$  unless otherwise specified

Symbol	Parameter	Test Conditions	Min	Typ	Max	Units
<b>On Characteristics</b>						
$V_{GS}$	Gate Threshold Voltage	$V_{DS} = V_{GS}, I_D = 250\ \mu\text{A}$	2.5	--	4.5	V
$R_{DS(ON)}$	Static Drain-Source On-Resistance	$V_{GS} = 10\ \text{V}, I_D = 5.5\ \text{A}$	--	0.93	1.15	$\Omega$

**Off Characteristics**

$BV_{DSS}$	Drain-Source Breakdown Voltage	$V_{GS} = 0\ \text{V}, I_D = 250\ \mu\text{A}$	900	--	--	V
$\Delta BV_{DSS}/\Delta T_J$	Breakdown Voltage Temperature Coefficient	$I_D = 250\ \mu\text{A}$ , Referenced to $25\text{ }^\circ\text{C}$	--	1.02	--	$\text{V}/^\circ\text{C}$
$I_{DSS}$	Zero Gate Voltage Drain Current	$V_{DS} = 900\ \text{V}, V_{GS} = 0\ \text{V}$	--	--	1	$\mu\text{A}$
		$V_{DS} = 720\ \text{V}, T_C = 125\text{ }^\circ\text{C}$	--	--	10	$\mu\text{A}$
$I_{GSSF}$	Gate-Body Leakage Current, Forward	$V_{GS} = 30\ \text{V}, V_{DS} = 0\ \text{V}$	--	--	100	nA
$I_{GSSR}$	Gate-Body Leakage Current, Reverse	$V_{GS} = -30\ \text{V}, V_{DS} = 0\ \text{V}$	--	--	-100	nA

**Dynamic Characteristics**

$C_{iss}$	Input Capacitance	$V_{DS} = 25\ \text{V}, V_{GS} = 0\ \text{V},$ $f = 1.0\ \text{MHz}$	--	3050	4000	pF
$C_{oss}$	Output Capacitance		--	260	340	pF
$C_{rss}$	Reverse Transfer Capacitance		--	28	36	pF

**Switching Characteristics**

$t_{d(on)}$	Turn-On Time	$V_{DS} = 450\ \text{V}, I_D = 11.0\ \text{A},$ $R_G = 25\ \Omega$	--	70	140	ns	
$t_r$	Turn-On Rise Time		--	155	310	ns	
$t_{d(off)}$	Turn-Off Delay Time		(Note 4,5)	--	155	310	ns
$t_f$	Turn-Off Fall Time			--	100	200	ns
$Q_g$	Total Gate Charge	$V_{DS} = 720\ \text{V}, I_D = 11.0\ \text{A},$ $V_{GS} = 10\ \text{V}$	--	75	100	nC	
$Q_{gs}$	Gate-Source Charge		(Note 4,5)	--	16	--	nC
$Q_{gd}$	Gate-Drain Charge			--	32	--	nC

**Source-Drain Diode Maximum Ratings and Characteristics**

$I_S$	Continuous Source-Drain Diode Forward Current	--	--	11.0	A	
$I_{SM}$	Pulsed Source-Drain Diode Forward Current	--	--	44		
$V_{SD}$	Source-Drain Diode Forward Voltage	$I_S = 11.0\ \text{A}, V_{GS} = 0\ \text{V}$	--	--	1.4	V
$t_{rr}$	Reverse Recovery Time	$I_S = 11.0\ \text{A}, V_{GS} = 0\ \text{V}$ $di/dt = 100\ \text{A}/\mu\text{s}$ (Note 4)	--	1200	--	ns
$Q_{rr}$	Reverse Recovery Charge		--	20.0	--	$\mu\text{C}$

**Notes ;**

1. Repetitive Rating : Pulse width limited by maximum junction temperature
2.  $L=15\text{mH}, I_{AS}=11.0\text{A}, V_{DD}=50\text{V}, R_G=25\Omega$ , Starting  $T_J=25\text{ }^\circ\text{C}$
3.  $I_{SD}\leq 11.0\text{A}, di/dt\leq 200\text{A}/\mu\text{s}, V_{DD}\leq BV_{DSS}$ , Starting  $T_J=25\text{ }^\circ\text{C}$
4. Pulse Test : Pulse Width  $\leq 300\mu\text{s}$ , Duty Cycle  $\leq 2\%$
5. Essentially Independent of Operating Temperature

Typical Characteristics

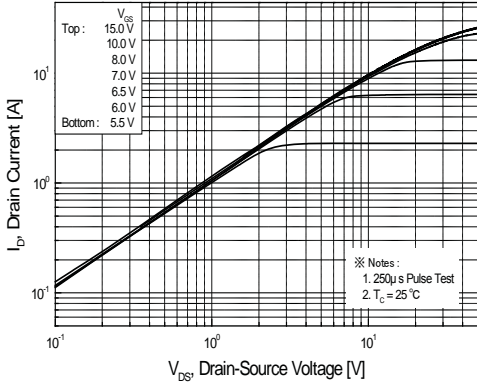

Figure 1. On Region Characteristics

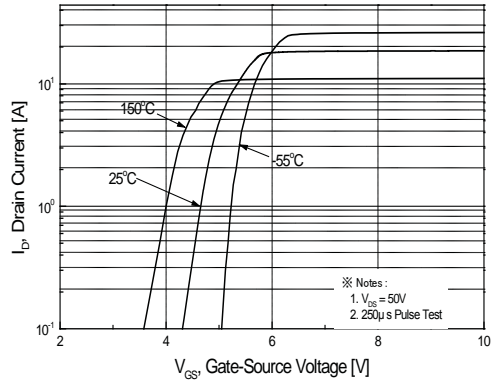

Figure 2. Transfer Characteristics

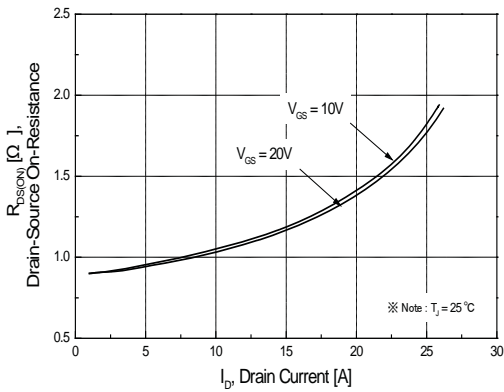

Figure 3. On Resistance Variation vs Drain Current and Gate Voltage

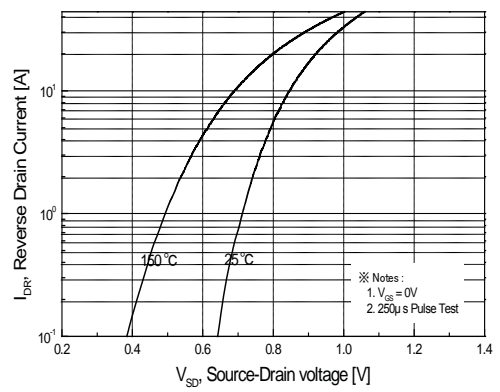

Figure 4. Body Diode Forward Voltage Variation with Source Current and Temperature

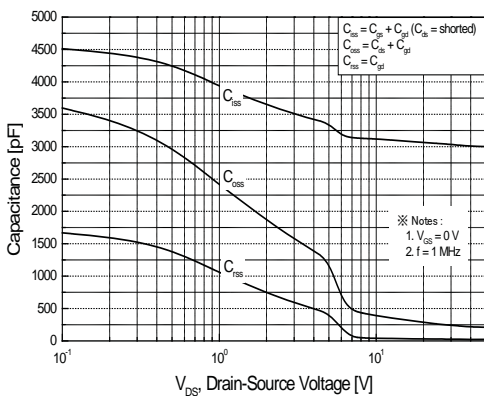

Figure 5. Capacitance Characteristics

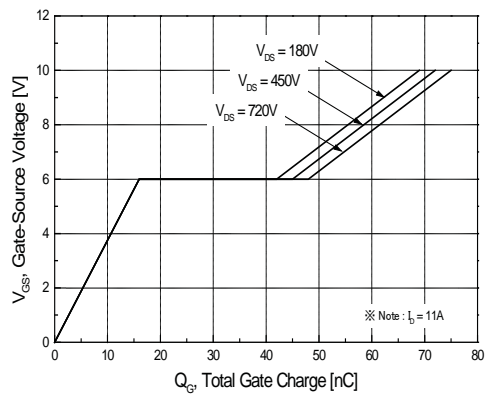

Figure 6. Gate Charge Characteristics

Typical Characteristics (continued)

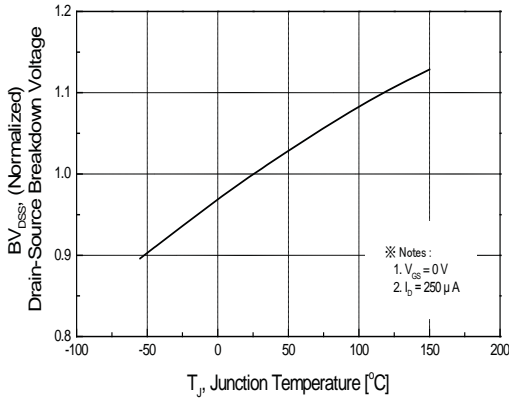

Figure 7. Breakdown Voltage Variation vs Temperature

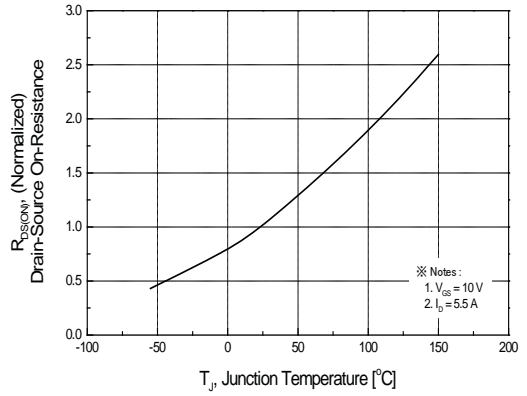

Figure 8. On-Resistance Variation vs Temperature

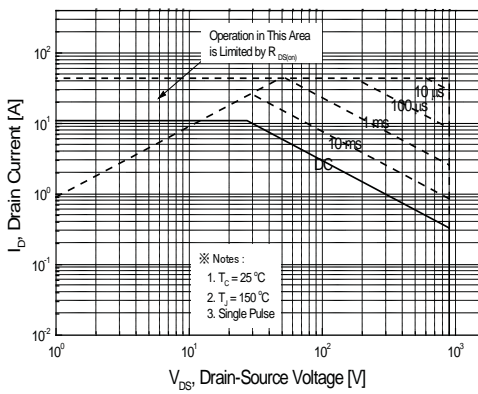

Figure 9. Maximum Safe Operating Area

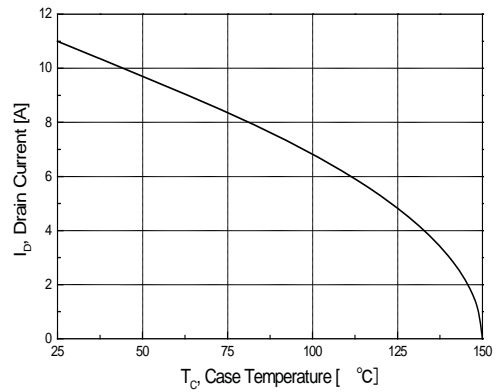

Figure 10. Maximum Drain Current vs Case Temperature

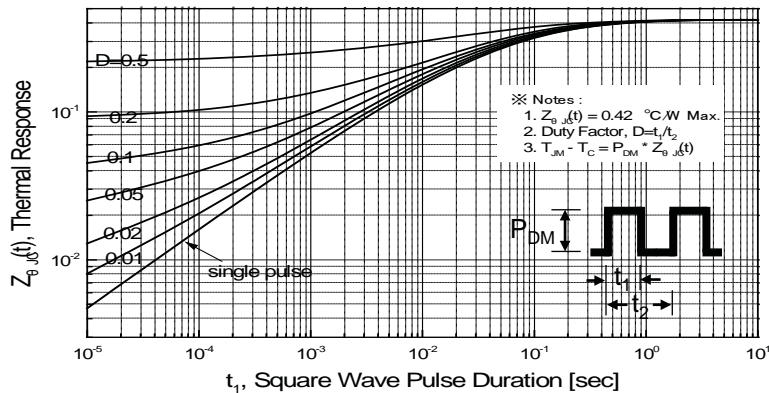

Figure 11. Transient Thermal Response Curve

Fig 12. Gate Charge Test Circuit & Waveform



Fig 13. Resistive Switching Test Circuit & Waveforms



Fig 14. Unclamped Inductive Switching Test Circuit & Waveforms

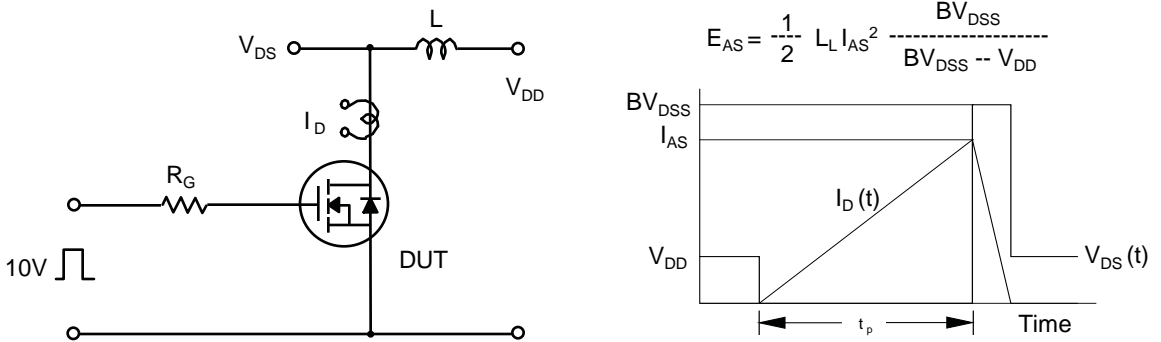
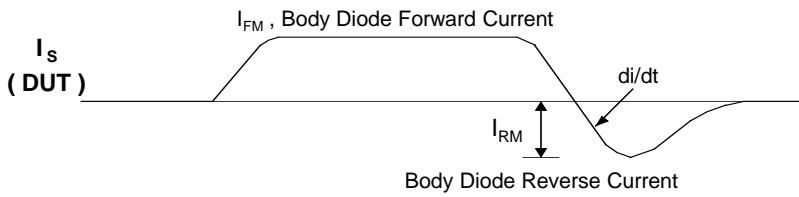

Fig 15. Peak Diode Recovery dv/dt Test Circuit & Waveforms



Package Dimension

TO-3P

