

HFP9N80 / HFS9N80

800V N-Channel MOSFET

Features

- Superior Avalanche Rugged Technology
- Robust Gate Oxide Technology
- Very Low Intrinsic Capacitances
- Excellent Switching Characteristics
- 100% Avalanche Tested
- RoHS Compliant

Key Parameters

Parameter	Value	Unit
BV_{DSS}	800	V
I_D	9	A
$R_{DS(on), Typ}$	1.2	Ω
Qg, Typ	48	nC

HFP9N80
TO-220

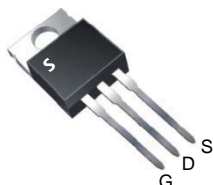

HFS9N80
TO-220F



Symbol

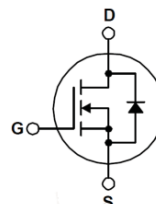

Absolute Maximum Ratings $T_C=25^\circ\text{C}$ unless otherwise specified

Symbol	Parameter	TO-220	TO-220F	Unit
V_{DSS}	Drain-Source Voltage	800		V
I_D	Drain Current – Continuous ($T_C = 25^\circ\text{C}$)	9.0	9.0 *	A
	Drain Current – Continuous ($T_C = 100^\circ\text{C}$)	5.7	5.7 *	A
I_{DM}	Drain Current – Pulsed (Note 1)	36	36 *	A
V_{GS}	Gate-Source Voltage	± 30		V
E_{AS}	Single Pulsed Avalanche Energy (Note 2)	860		mJ
I_{AR}	Avalanche Current (Note 1)	9.0		A
E_{AR}	Repetitive Avalanche Energy (Note 1)	17.8		mJ
dv/dt	Peak Diode Recovery dv/dt (Note 3)	4.5		V/ns
P_D	Power Dissipation ($T_C = 25^\circ\text{C}$)	178	59	W
	- Derate above 25°C	1.42	0.48	W/ $^\circ\text{C}$
T_J, T_{STG}	Operating and Storage Temperature Range	-55 to +150		$^\circ\text{C}$
T_L	Maximum lead temperature for soldering purposes, 1/8" from case for 5 seconds	300		$^\circ\text{C}$

* Drain current limited by maximum junction temperature

Thermal Resistance Characteristics

Symbol	Parameter	TO-220	TO-220F	Unit
$R_{\theta JC}$	Thermal Resistance, Junction-to-Case, Max.	0.7	2.1	$^\circ\text{C}/\text{W}$
$R_{\theta CS}$	Thermal Resistance, Case-to-Sink, Typ.	0.5	--	$^\circ\text{C}/\text{W}$
$R_{\theta JA}$	Thermal Resistance, Junction-to-Ambient, Max.	62.5	62.5	$^\circ\text{C}/\text{W}$

Electrical Characteristics $T_J=25^\circ\text{C}$ unless otherwise specified

Symbol	Parameter	Test Conditions	Min	Typ	Max	Unit
On Characteristics						
V_{GS}	Gate Threshold Voltage	$V_{DS} = V_{GS}, I_D = 250 \mu\text{A}$	2.0	--	4.0	V
$R_{DS(ON)}$	Static Drain-Source On-Resistance	$V_{GS} = 10 \text{ V}, I_D = 4.5 \text{ A}$	--	1.2	1.44	Ω
g_{FS}	Forward Transconductance	$V_{DS} = 50 \text{ V}, I_D = 4.5 \text{ A}$	--	5.5	--	S
Off Characteristics						
BV_{DSS}	Drain-Source Breakdown Voltage	$V_{GS} = 0 \text{ V}, I_D = 250 \mu\text{A}$	800	--	--	V
$\Delta BV_{DSS} / \Delta T_J$	Breakdown Voltage Temperature Coefficient	$I_D = 250 \mu\text{A}$, Referenced to 25°C	--	0.93	--	$\text{V}/^\circ\text{C}$
I_{DSS}	Zero Gate Voltage Drain Current	$V_{DS} = 800 \text{ V}, V_{GS} = 0 \text{ V}$	--	--	10	μA
		$V_{DS} = 640 \text{ V}, T_C = 125^\circ\text{C}$	--	--	100	μA
I_{GSS}	Gate-Body Leakage Current	$V_{GS} = \pm 30 \text{ V}, V_{DS} = 0 \text{ V}$	--	--	± 100	nA
Dynamic Characteristics						
C_{iss}	Input Capacitance	$V_{DS} = 25 \text{ V}, V_{GS} = 0 \text{ V}, f = 1.0 \text{ MHz}$	--	1770	2300	pF
C_{oss}	Output Capacitance		--	145	190	pF
C_{rss}	Reverse Transfer Capacitance		--	25	33	pF
Switching Characteristics						
$t_{d(on)}$	Turn-On Time	$V_{DS} = 400 \text{ V}, I_D = 9 \text{ A}, R_G = 25 \Omega$ (Note 4,5)	--	45	100	ns
t_r	Turn-On Rise Time		--	38	86	ns
$t_{d(off)}$	Turn-Off Delay Time		--	170	350	ns
t_f	Turn-Off Fall Time		--	35	80	ns
Q_g	Total Gate Charge	$V_{DS} = 640 \text{ V}, I_D = 9 \text{ A}, V_{GS} = 10 \text{ V}$ (Note 4,5)	--	48	62	nC
Q_{gs}	Gate-Source Charge		--	10	--	nC
Q_{gd}	Gate-Drain Charge		--	19	--	nC
Drain-Source Diode Characteristics and Maximum Ratings						
I_S	Maximum Continuous Drain-Source Diode Forward Current		--	--	9	A
I_{SM}	Maximum Pulsed Drain-Source Diode Forward Current		--	--	36	
V_{SD}	Drain-Source Diode Forward Voltage	$V_{GS} = 0 \text{ V}, I_S = 9 \text{ A}$	--	--	1.4	V
t_{rr}	Reverse Recovery Time	$V_{GS} = 0 \text{ V}, I_S = 9 \text{ A}, di_F/dt = 100 \text{ A}/\mu\text{s}$	--	690	--	ns
Q_{rr}	Reverse Recovery Charge		--	8.2	--	μC

Notes :

1. Repetitive Rating : Pulse width limited by maximum junction temperature
2. $L=20\text{mH}, I_{AS}=9\text{A}, V_{DD}=50\text{V}, R_G=25\Omega$, Starting $T_J=25^\circ\text{C}$
3. $I_{SD}\leq 9\text{A}, di/dt\leq 200\text{A}/\mu\text{s}, V_{DD}\leq BV_{DSS}$, Starting $T_J=25^\circ\text{C}$
4. Pulse Test : Pulse Width $\leq 300\mu\text{s}$, Duty Cycle $\leq 2\%$
5. Essentially Independent of Operating Temperature

Typical Characteristics

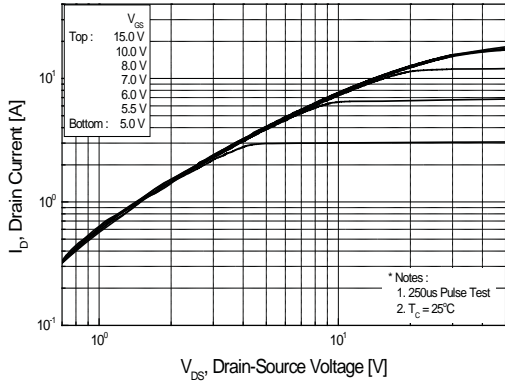

Figure 1. On Region Characteristics

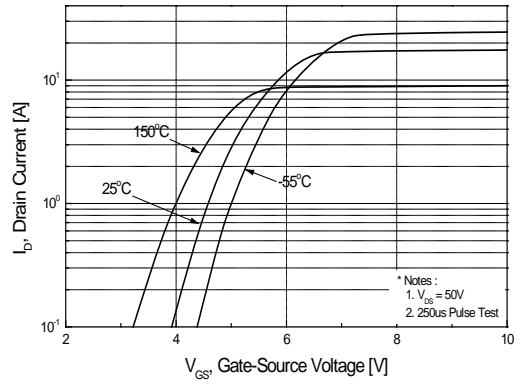

Figure 2. Transfer Characteristics

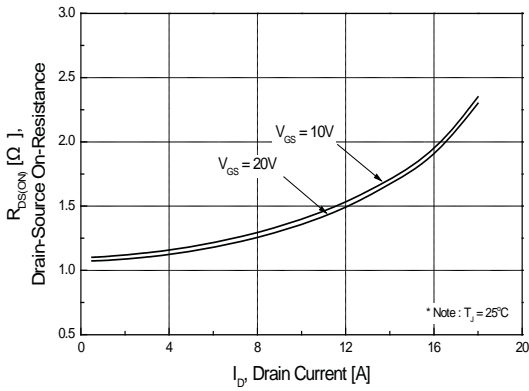

Figure 3. On Resistance Variation vs Drain Current and Gate Voltage

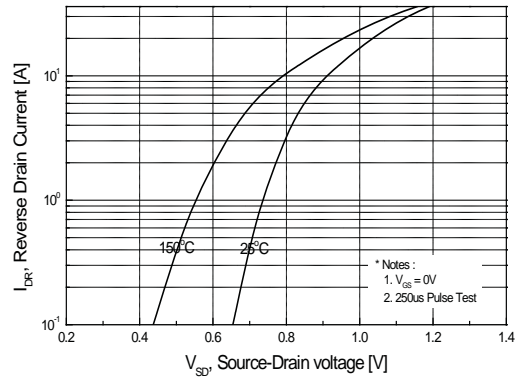

Figure 4. Body Diode Forward Voltage Variation with Source Current and Temperature

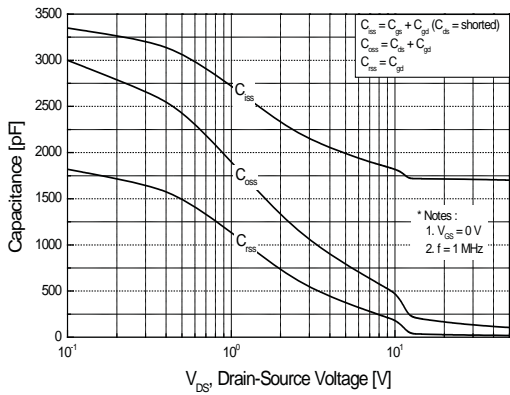

Figure 5. Capacitance Characteristics

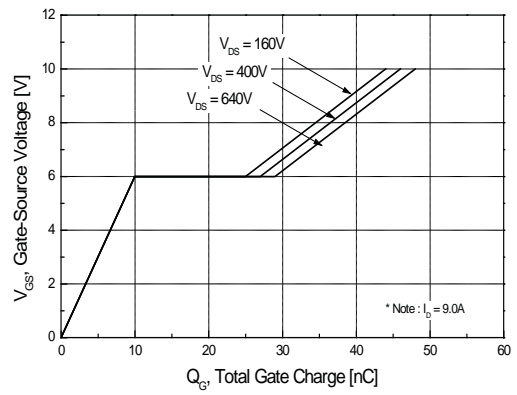

Figure 6. Gate Charge Characteristics

Typical Characteristics (continued)

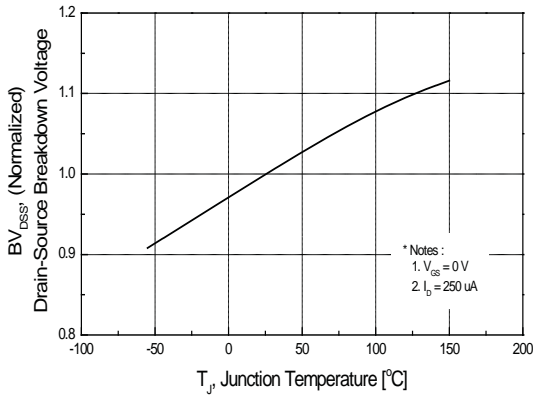

Figure 7. Breakdown Voltage Variation vs Temperature

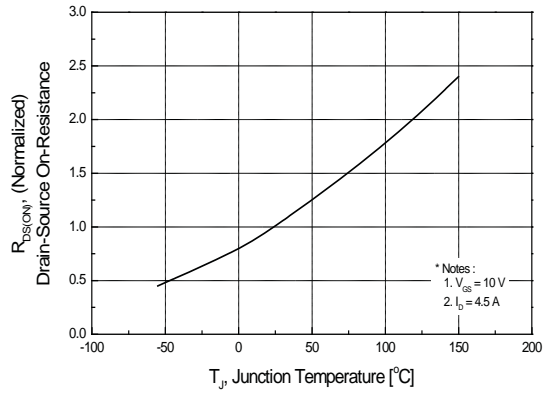

Figure 8. On-Resistance Variation vs Temperature

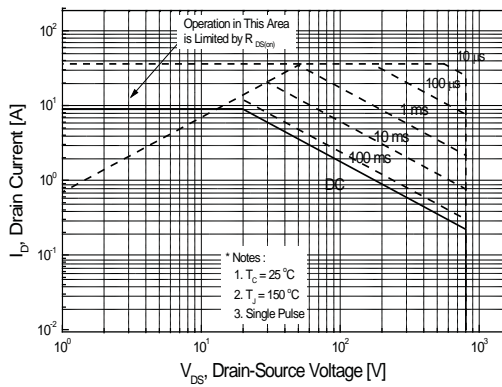

Figure 9-1. Maximum Safe Operating Area for TO-220

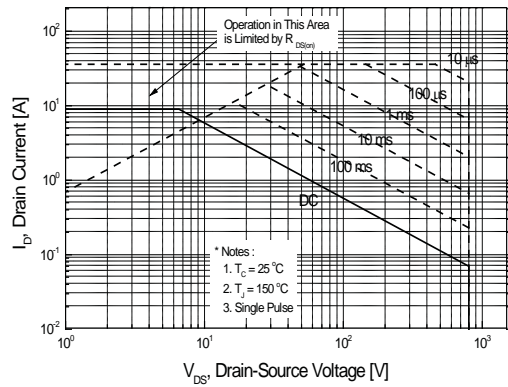

Figure 9-2. Maximum Safe Operating Area for TO-220F

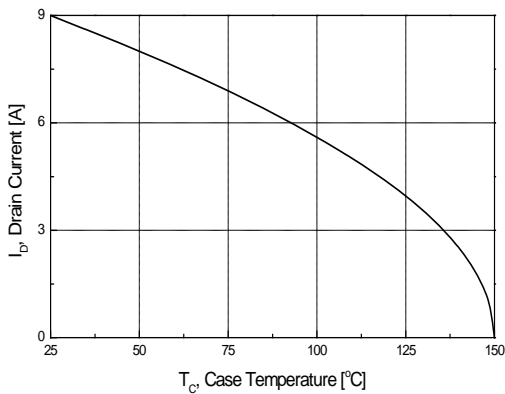

Figure 10. Maximum Drain Current vs Case Temperature

Typical Characteristics (continued)

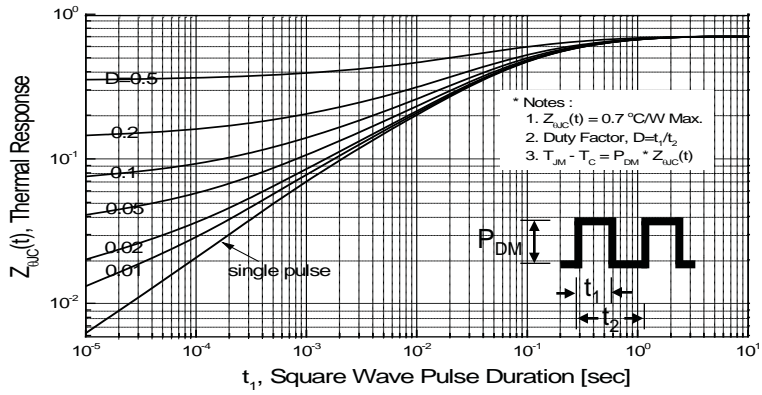

Figure 11-1. Transient Thermal Response Curve for TO-220

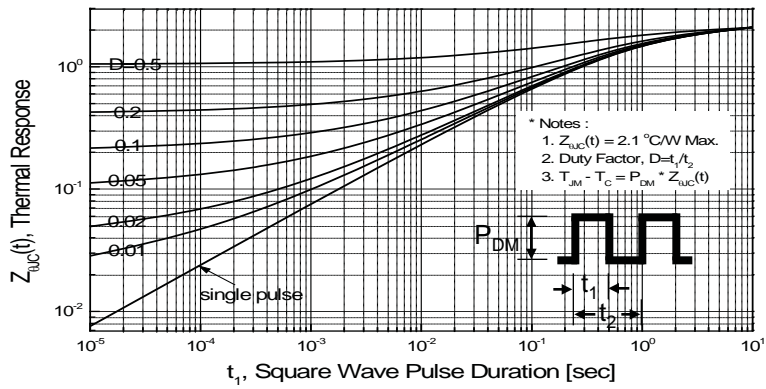

Figure 11-2. Transient Thermal Response Curve for TO-220F

Fig 12. Gate Charge Test Circuit & Waveform

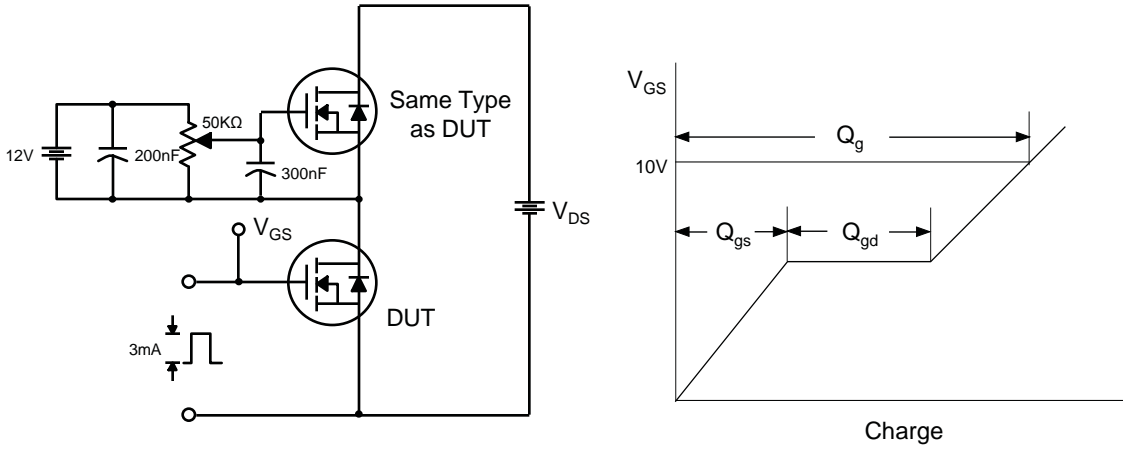

Fig 13. Resistive Switching Test Circuit & Waveforms

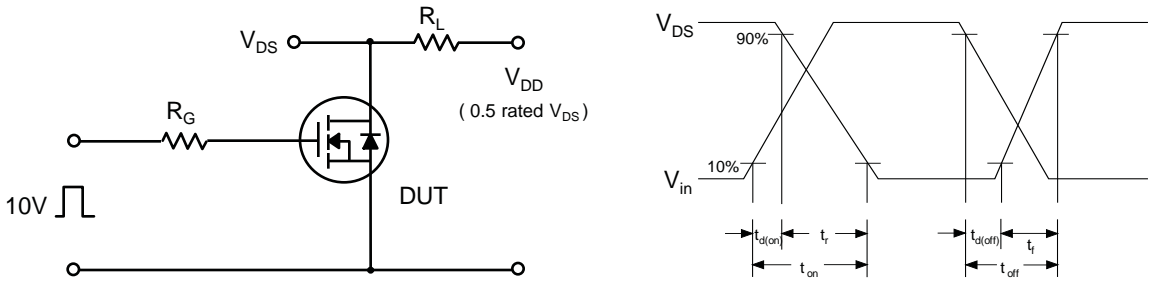

Fig 14. Unclamped Inductive Switching Test Circuit & Waveforms

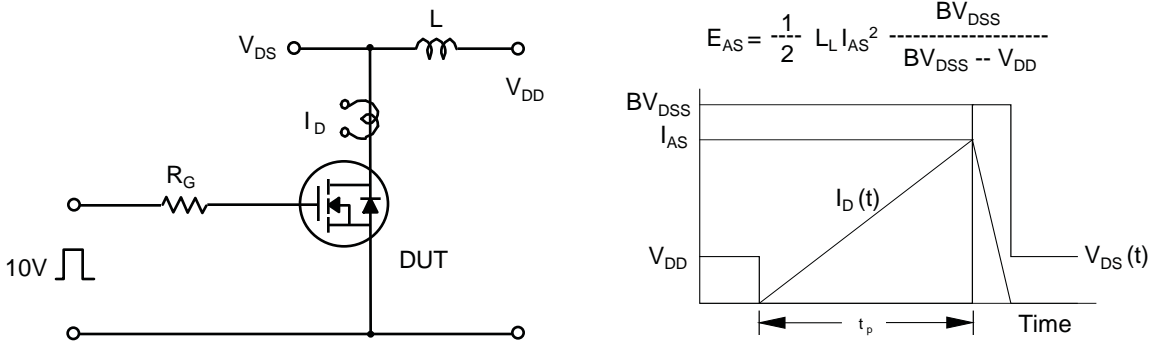
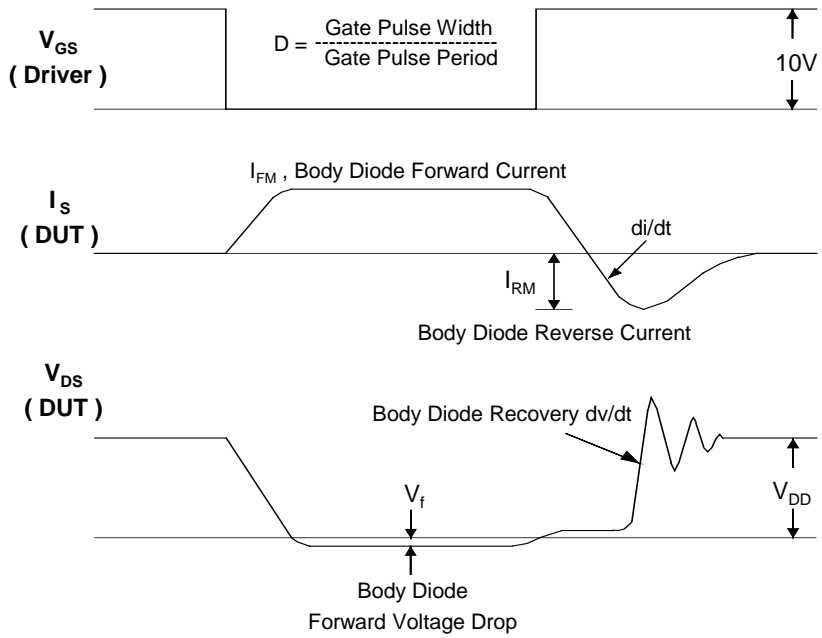
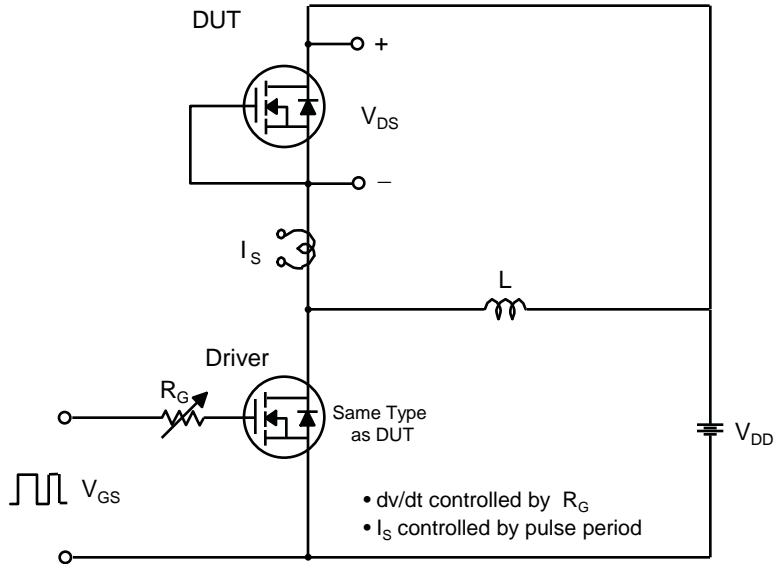
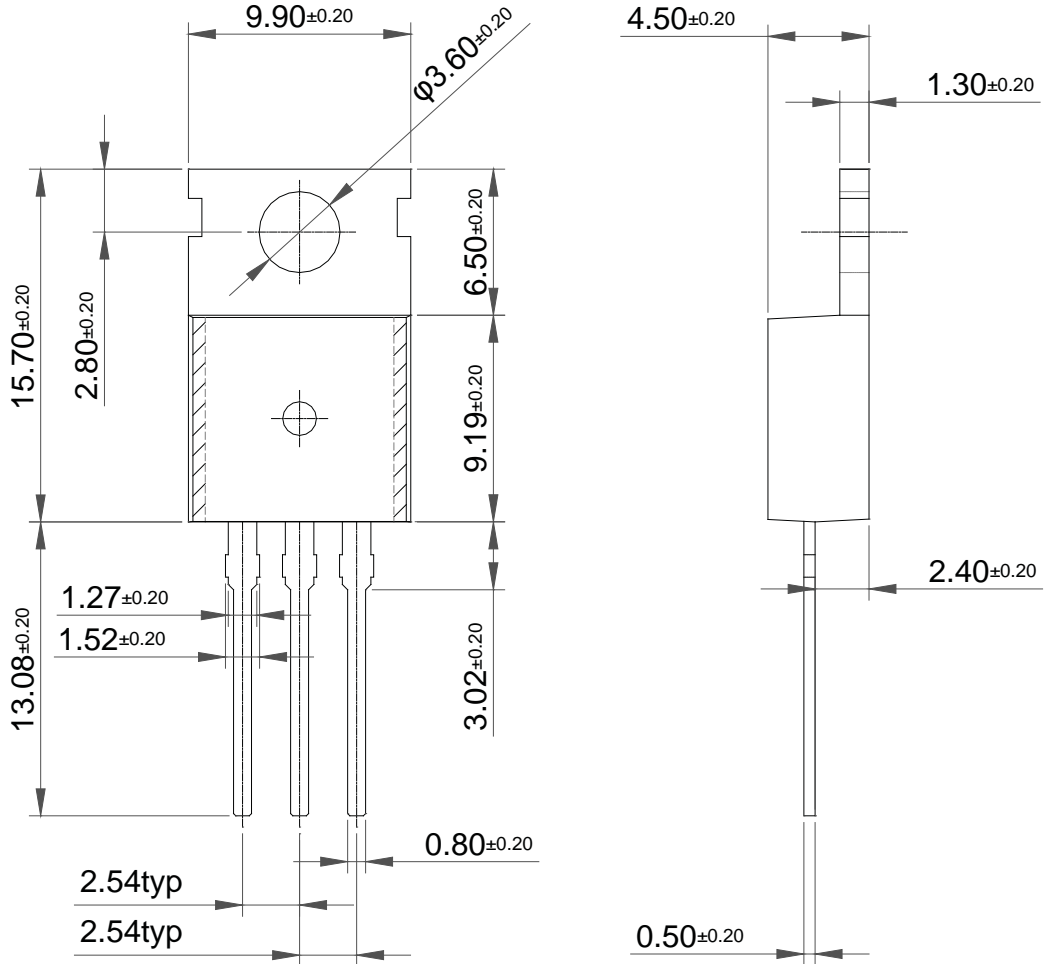

Fig 15. Peak Diode Recovery dv/dt Test Circuit & Waveforms



Package Dimension

TO-220



Package Dimension

TO-220F

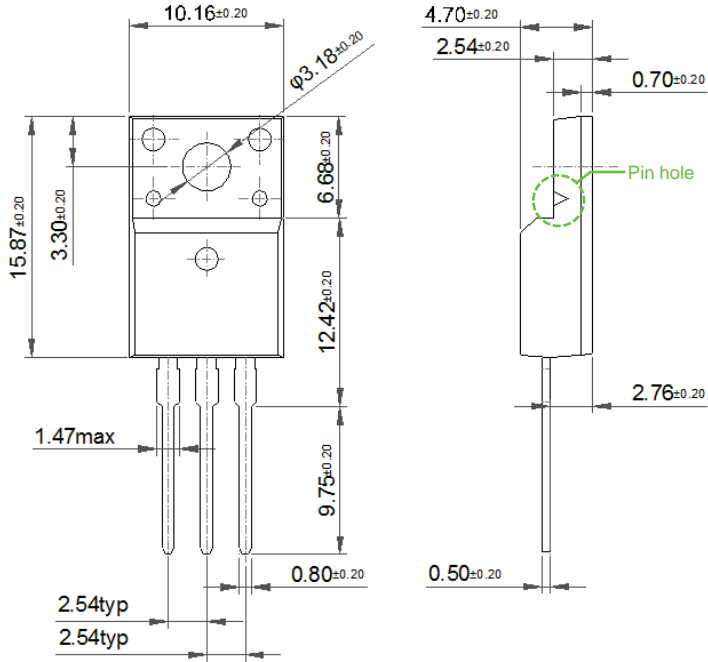

TO-220F-FM

