

## HFD8N60U / HFU8N60U 600V N-Channel MOSFET

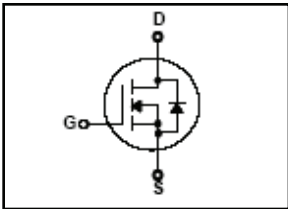
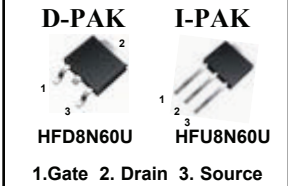
### FEATURES

- Originative New Design
- Superior Avalanche Rugged Technology
- Robust Gate Oxide Technology
- Very Low Intrinsic Capacitances
- Excellent Switching Characteristics
- Unrivalled Gate Charge : 22.0 nC (Typ.)
- Extended Safe Operating Area
- Lower  $R_{DS(ON)}$  : 0.96  $\Omega$  (Typ.) @  $V_{GS}=10V$
- 100% Avalanche Tested

$$BV_{DSS} = 600 \text{ V}$$

$$R_{DS(on) \text{ typ}} = 0.96 \ \Omega$$

$$I_D = 6.0 \text{ A}$$



### Absolute Maximum Ratings $T_C=25^\circ\text{C}$ unless otherwise specified

Symbol	Parameter	Value	Units
$V_{DSS}$	Drain-Source Voltage	600	V
$I_D$	Drain Current – Continuous ( $T_C = 25^\circ\text{C}$ )	6.0	A
	Drain Current – Continuous ( $T_C = 100^\circ\text{C}$ )	3.8	A
$I_{DM}$	Drain Current – Pulsed (Note 1)	24.0	A
$V_{GS}$	Gate-Source Voltage	$\pm 30$	V
$E_{AS}$	Single Pulsed Avalanche Energy (Note 2)	280	mJ
$I_{AR}$	Avalanche Current (Note 1)	6.0	A
$E_{AR}$	Repetitive Avalanche Energy (Note 1)	9.8	mJ
dv/dt	Peak Diode Recovery dv/dt (Note 3)	4.5	V/ns
$P_D$	Power Dissipation ( $T_A = 25^\circ\text{C}$ )*	2.5	W
	Power Dissipation ( $T_C = 25^\circ\text{C}$ )	98	W
	- Derate above $25^\circ\text{C}$	0.78	W/ $^\circ\text{C}$
$T_J, T_{STG}$	Operating and Storage Temperature Range	-55 to +150	$^\circ\text{C}$
$T_L$	Maximum lead temperature for soldering purposes, 1/8" from case for 5 seconds	300	$^\circ\text{C}$

### Thermal Resistance Characteristics

Symbol	Parameter	Typ.	Max.	Units
$R_{\theta JC}$	Junction-to-Case	--	1.28	$^\circ\text{C}/\text{W}$
$R_{\theta JA}$	Junction-to-Ambient*	--	50	
$R_{\theta JA}$	Junction-to-Ambient	--	110	

\* When mounted on the minimum pad size recommended (PCB Mount)

### Package Marking and Odering Information

Device Marking	Week Marking	Package	Packing	Quantity	RoHS Status
HFD8N60U	YWWX	TO-252	Reel	2,500	Pb Free
HFD8N60U	YWWXg	TO-252	Reel	2,500	Halogen Free
HFU8N60U	YWWX	TO-251	Tube	80	Pb Free
HFU8N60U	YWWXg	TO-251	Tube	80	Halogen Free

### Electrical Characteristics $T_C=25^\circ\text{C}$ unless otherwise specified

Symbol	Parameter	Test Conditions	Min	Typ	Max	Units
<b>On Characteristics</b>						
$V_{GS}$	Gate Threshold Voltage	$V_{DS} = V_{GS}, I_D = 250 \mu\text{A}$	2.5	--	4.5	V
$R_{DS(ON)}$	Static Drain-Source On-Resistance	$V_{GS} = 10 \text{ V}, I_D = 3.0 \text{ A}$	--	0.96	1.2	$\Omega$

### Off Characteristics

$BV_{DSS}$	Drain-Source Breakdown Voltage	$V_{GS} = 0 \text{ V}, I_D = 250 \mu\text{A}$	600	--	--	V
$\Delta BV_{DSS} / \Delta T_J$	Breakdown Voltage Temperature Coefficient	$I_D = 250 \mu\text{A}$ , Referenced to $25^\circ\text{C}$	--	0.6	--	$\text{V}/^\circ\text{C}$
$I_{DSS}$	Zero Gate Voltage Drain Current	$V_{DS} = 600 \text{ V}, V_{GS} = 0 \text{ V}$	--	--	1	$\mu\text{A}$
		$V_{DS} = 480 \text{ V}, T_C = 125^\circ\text{C}$	--	--	10	$\mu\text{A}$
$I_{GSS}$	Gate-Body Leakage Current	$V_{GS} = \pm 30 \text{ V}, V_{DS} = 0 \text{ V}$	--	--	$\pm 100$	nA

### Dynamic Characteristics

$C_{iss}$	Input Capacitance	$V_{DS} = 25 \text{ V}, V_{GS} = 0 \text{ V},$ $f = 1.0 \text{ MHz}$	--	1200	1560	pF
$C_{oss}$	Output Capacitance		--	100	130	pF
$C_{rss}$	Reverse Transfer Capacitance		--	11.0	14.5	pF

### Switching Characteristics

$t_{d(on)}$	Turn-On Time	$V_{DS} = 300 \text{ V}, I_D = 7.5 \text{ A},$ $R_G = 25 \Omega$	--	35	70	ns
$t_r$	Turn-On Rise Time		--	50	100	ns
$t_{d(off)}$	Turn-Off Delay Time		--	120	240	ns
$t_f$	Turn-Off Fall Time		(Note 4,5)	--	50	100
$Q_g$	Total Gate Charge	$V_{DS} = 480 \text{ V}, I_D = 7.5 \text{ A},$ $V_{GS} = 10 \text{ V}$	--	22.0	29.0	nC
$Q_{gs}$	Gate-Source Charge		--	6.5	--	nC
$Q_{gd}$	Gate-Drain Charge		(Note 4,5)	--	6.5	--

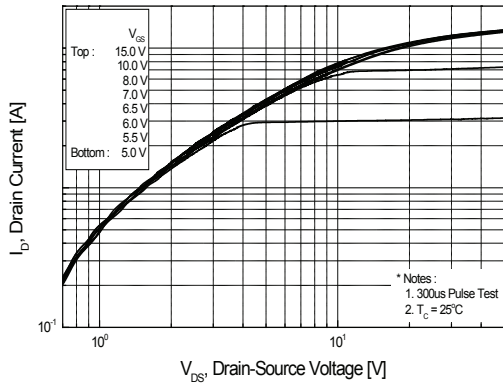
### Source-Drain Diode Maximum Ratings and Characteristics

$I_S$	Continuous Source-Drain Diode Forward Current	--	--	6.0	A	
$I_{SM}$	Pulsed Source-Drain Diode Forward Current	--	--	24		
$V_{SD}$	Source-Drain Diode Forward Voltage	$I_S = 6.0 \text{ A}, V_{GS} = 0 \text{ V}$	--	--	1.4	V
$t_{rr}$	Reverse Recovery Time	$I_S = 7.5 \text{ A}, V_{GS} = 0 \text{ V}$ $di_F/dt = 100 \text{ A}/\mu\text{s}$ (Note 4)	--	350	--	ns
$Q_{rr}$	Reverse Recovery Charge		--	3.3	--	$\mu\text{C}$

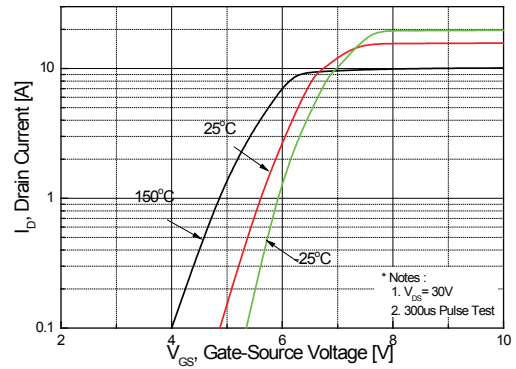
#### Notes ;

1. Repetitive Rating : Pulse width limited by maximum junction temperature
2.  $L=9.0\text{mH}, I_{AS}=7.5\text{A}, V_{DD}=50\text{V}, R_G=25\Omega$ , Starting  $T_J=25^\circ\text{C}$
3.  $I_{SD}\leq 6.0\text{A}, di/dt\leq 200\text{A}/\mu\text{s}, V_{DD}\leq BV_{DSS}$ , Starting  $T_J=25^\circ\text{C}$
4. Pulse Test : Pulse Width  $\leq 300\mu\text{s}$ , Duty Cycle  $\leq 2\%$
5. Essentially Independent of Operating Temperature

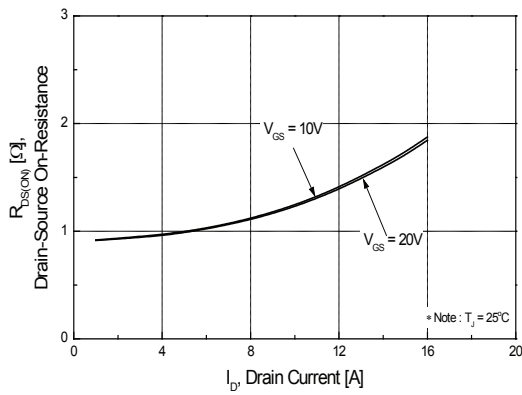
# Typical Characteristics



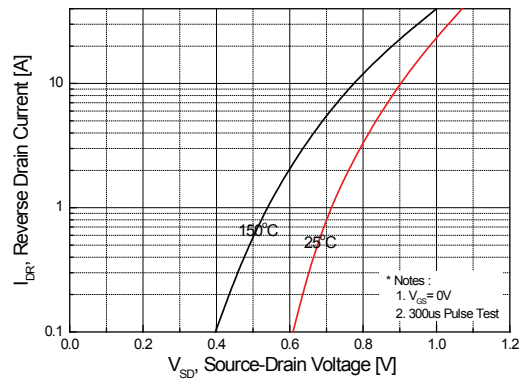
**Figure 1. On Region Characteristics**



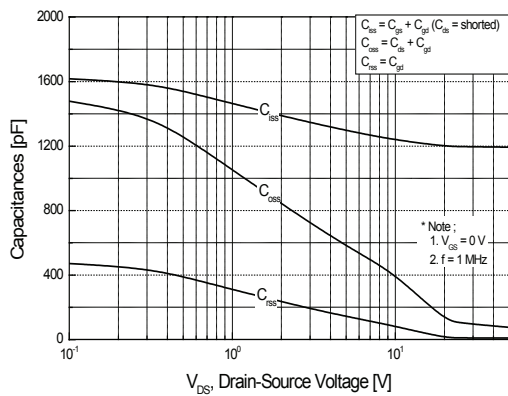
**Figure 2. Transfer Characteristics**



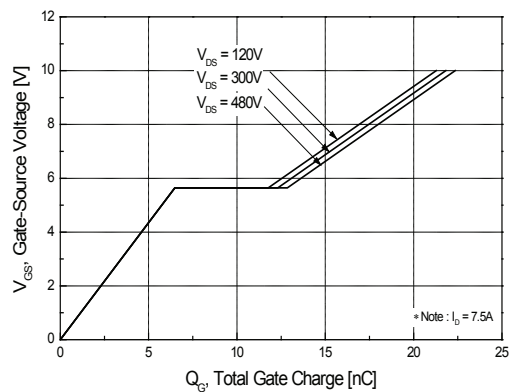
**Figure 3. On Resistance Variation vs Drain Current and Gate Voltage**



**Figure 4. Body Diode Forward Voltage Variation with Source Current and Temperature**

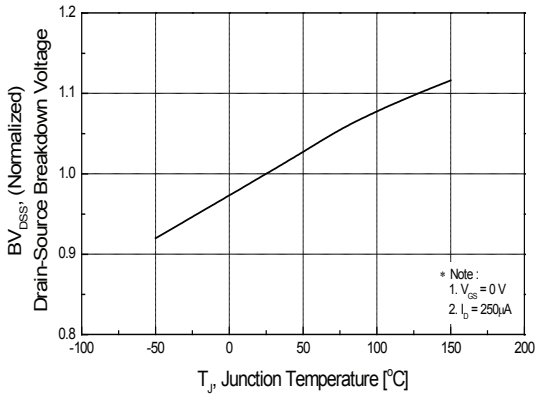


**Figure 5. Capacitance Characteristics**

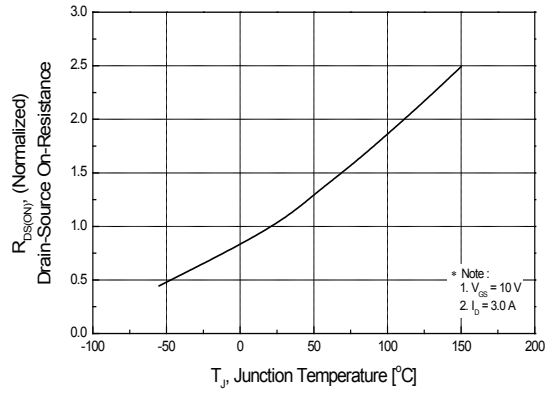


**Figure 6. Gate Charge Characteristics**

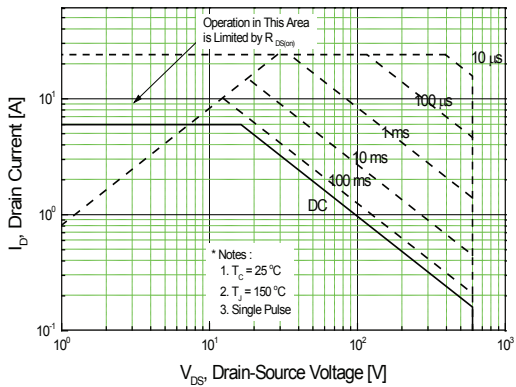
**Typical Characteristics (continued)**



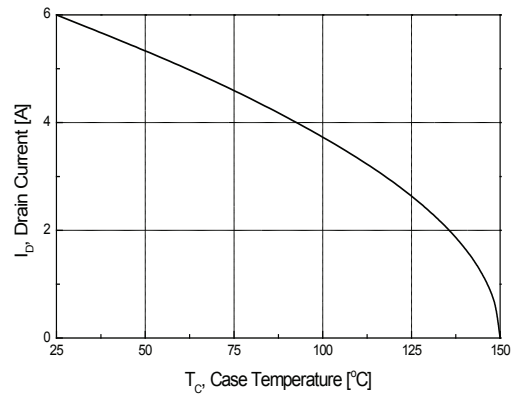
**Figure 7. Breakdown Voltage Variation vs Temperature**



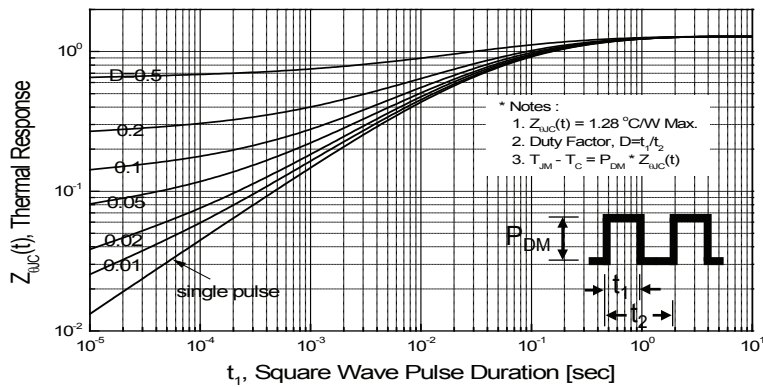
**Figure 8. On-Resistance Variation vs Temperature**



**Figure 9. Maximum Safe Operating Area**

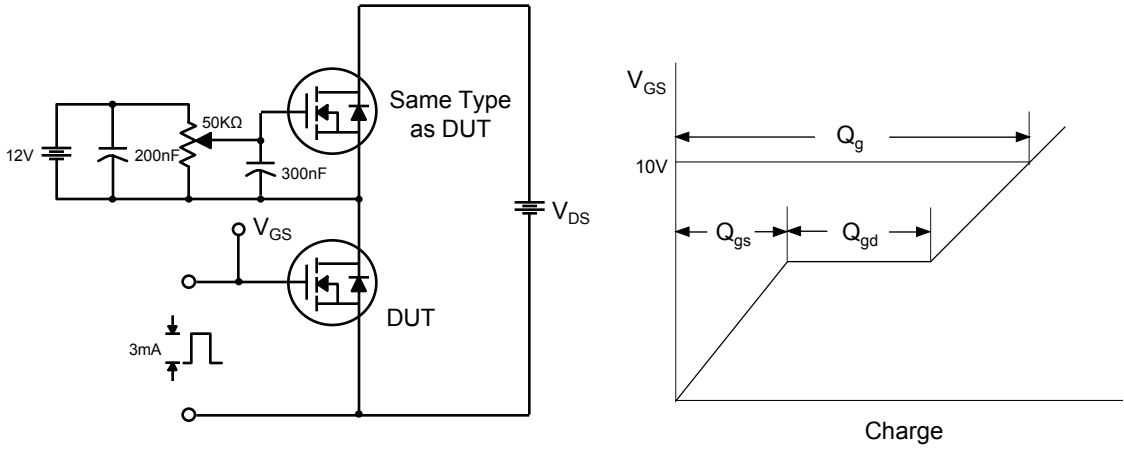


**Figure 10. Maximum Drain Current vs Case Temperature**

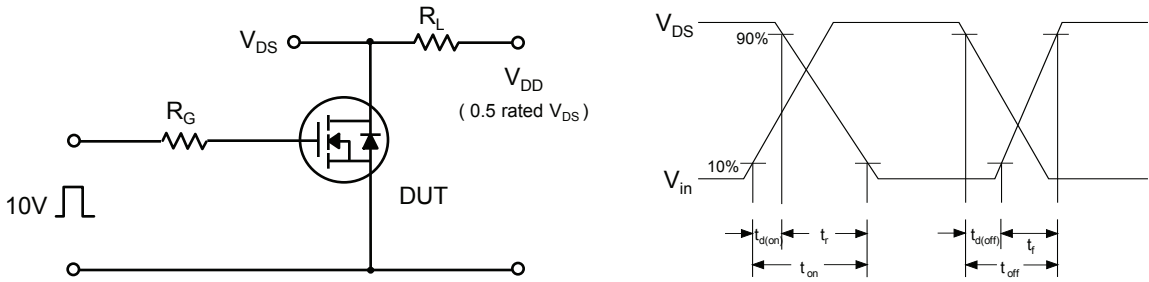


**Figure 11. Transient Thermal Response Curve**

**Fig 12. Gate Charge Test Circuit & Waveform**



**Fig 13. Resistive Switching Test Circuit & Waveforms**



**Fig 14. Unclamped Inductive Switching Test Circuit & Waveforms**

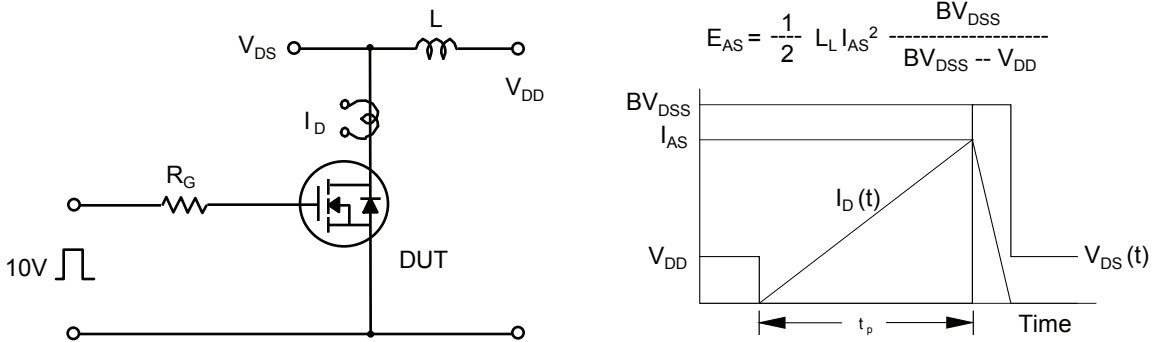
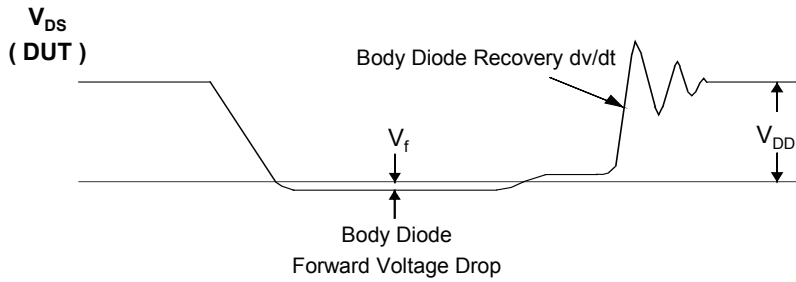
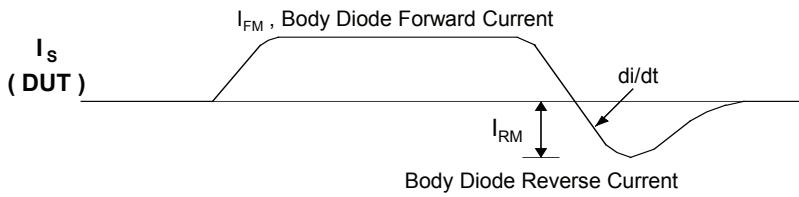
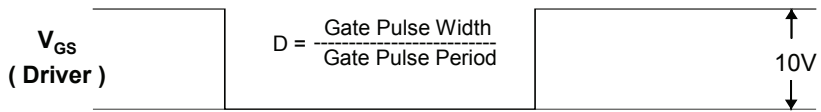
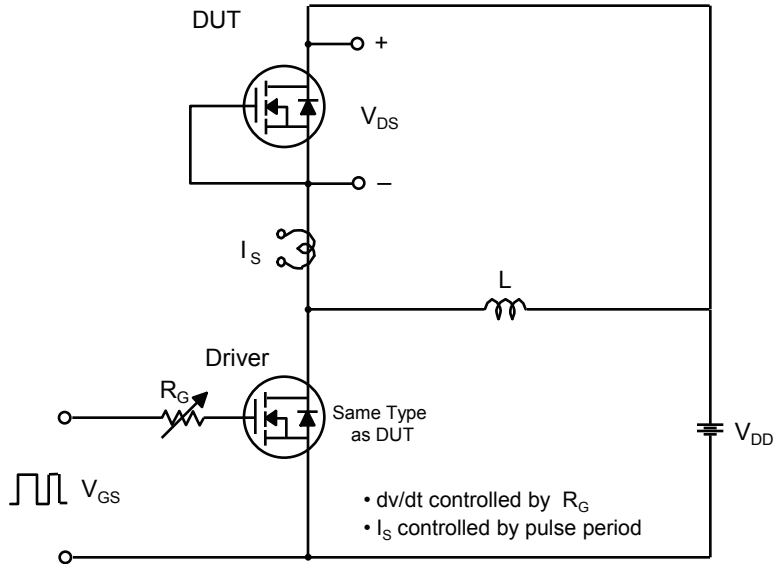
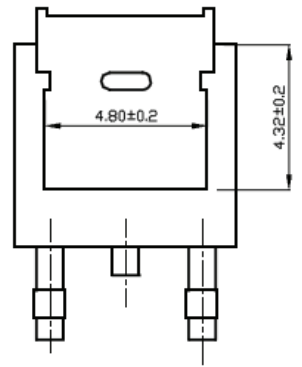
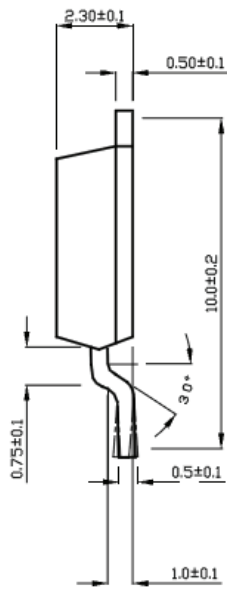
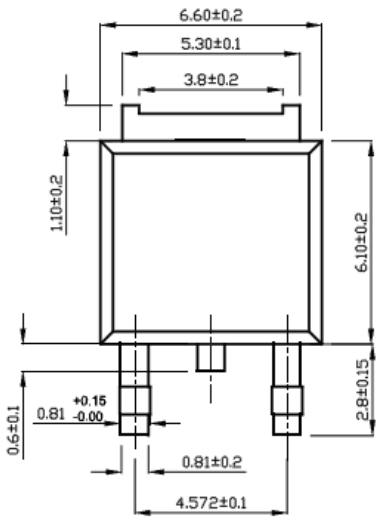


Fig 15. Peak Diode Recovery dv/dt Test Circuit & Waveforms



Package Dimension

TO-252



Package Dimension

TO-251

